

UNION TOOL COMPANY

Tungsten Carbide End Mills

UNIMAX Series

Vol.20



Simplified Table

1 Flute

2 Flutes

3 Flutes

4 Flutes

5 Flutes

6 Flutes

UDC Series

CBN Series

Square

Long Neck Square

Radius

Long Neck Radius

Taper Neck Radius

Ball / Long Shank Ball

Long Neck Ball

Taper Neck Ball

Taper

Spiral V Cutter

Drill

EURO Series

Technical Data



UNION TOOL CO.

UNION TOOL is

High quality

Time - saving

Variety - rich

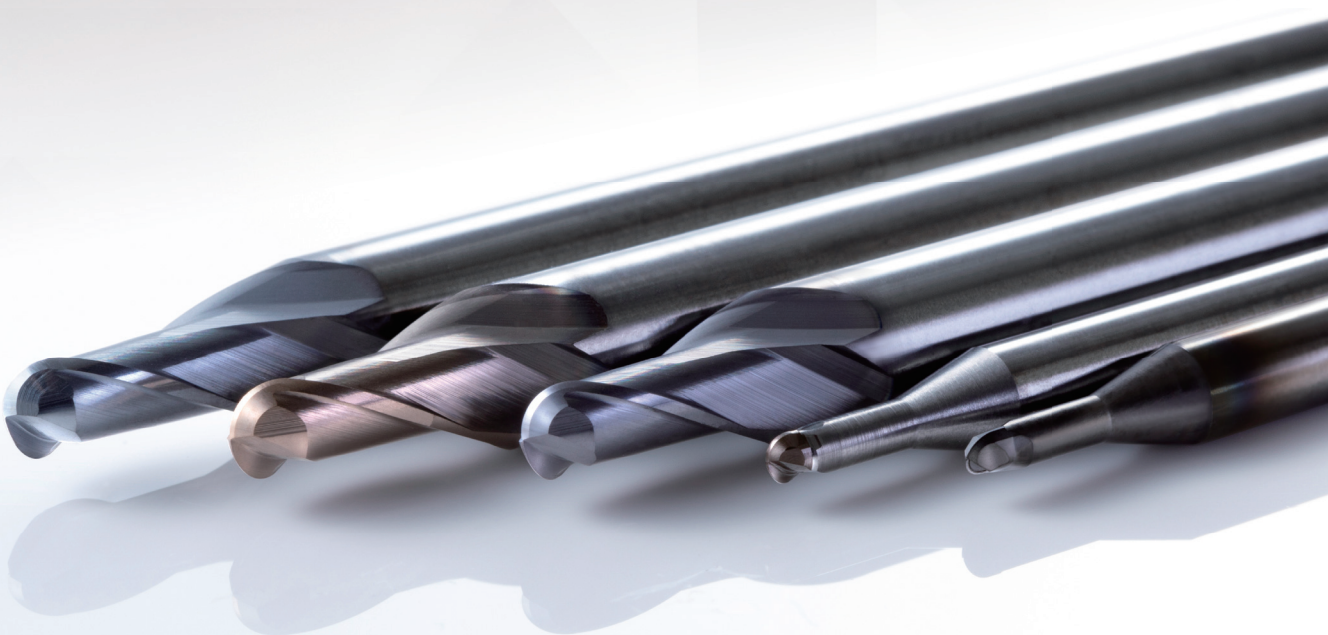

TOOLING

- Simplified Table
- 1 Flute
- 2 Flutes
- 3 Flutes
- 4 Flutes
- 5 Flutes
- 6 Flutes

● UDC Series / 78-113 

● CBN Series / 114-139

● Square / 140-229 

● Long Neck Square / 230-289 

● Radius / 290-315 

● Long Neck Radius / 316-385 

● Taper Neck Radius / 386-395 

● Ball / Long Shank Ball / 396-433 

● Long Neck Ball / 434-507 

● Taper Neck Ball / 508-533 

● Taper / 534-541 

● Spiral V Cutter / 542-543 

● Drill / 544-562 

● EURO Series / 563-571

● Technical Data / 572-592

- Simplified Table
- 1 Flute
- 2 Flutes
- 3 Flutes
- 4 Flutes
- 5 Flutes
- 6 Flutes
- UDC Series
- CBN Series
- Square
- Long Neck Square
- Radius
- Long Neck Radius
- Taper Neck Radius
- Ball / Long Shank Ball
- Long Neck Ball
- Taper Neck Ball
- Taper
- Spiral V Cutter
- Drill
- EURO Series
- Technical Data

Index

Alphabetical Order

Model Number	Page	Characteristic
A		
AZS	266	3 Flute Long Neck Square
C		
CAS	180	2 Flute Square
CBN-LBF	120	2 Flute CBN Long Neck Ball
CBN-LBSF	114	2 Flute CBN Long Neck Ball
CBN-LRF	132	2 Flute CBN Long Neck Radius
CBN-RSF	126	1 Flute CBN Long Neck Radius
CESUS	216	4 Flute Square
CFB	416	3 Flute Ball
CFLB	502	3 Flute Long Neck Ball
CGB2000	414	2 Flute Ball
CGB4000	432	4 Flute Ball
CGE	224	4 Flute Square
CNRS	294	4 Flute Radius
CPR	258	2 Flute Long Neck Square
CPRB	498	2 Flute Long Neck Ball
CPRL	262	2 Flute Long Neck Square (Long Shank)
CPRS25NSP	564	2 Flute Radius / Long Neck Radius
CPRS30N	566	2 Flute Long Neck Radius
CPS	178	2 Flute Square
CRN-ES2000	174	2 Flute Square

Model Number	Page	Characteristic
CRN-ES4000	220	4 Flute Square
CRRS	370	4 Flute Long Neck Radius
CRS20HSP	570	4 Flute Long Neck Radius
CRS40HSP	568	3 Flute Long Neck Radius (Short Length of Cut)
CSEB	406	2 Flute Ball (R0.05/0.2 Length of Cut: Single Flute)
CSELB	468	2 Flute Long Neck Ball for Deep Rib Milling
CSS	140	2 Flute Square
CXERS	298	4 Flute Radius
CXES	196	4 Flute Square
CXLRS	380	5 Flute Long Neck Radius
CXRS	308	5 Flute Radius
CXS	282	4 Flute Long Neck Square
CZS	182	4 Flute Square
C-CER	244	2 Flute Long Neck Square for Deep Rib Milling
C-CES2000	154	2 Flute Square
C-CES2000S	168	2 Flute Square (Sharp Corner)
C-CES4000	208	4 Flute Square
C-CES4000S	214	4 Flute Square (Sharp Corner)
C-CRS	290	2 Flute Radius
C-CTE2000	534	2 Flute Taper
C-CTE4000	538	4 Flute Taper
C-UMD	552	2 Flute UNIMAX Drill

Index

Alphabetical Order

Model Number	Page	Characteristic
--------------	------	----------------

D

DCB	412	2 Flute Ball
DCES2000	176	2 Flute Square
DCES4000	222	4 Flute Square
DCLB	484	2 Flute Long Neck Ball
DCLRS	376	4 Flute Long Neck Radius
DCLS	254	2 Flute Long Neck Square
DCTNB	526	2 Flute Taper Neck Ball
DLC-AZS	270	3 Flute Long Neck Square
DLC-CFB	422	3 Flute Ball
DLCLB	488	2 Flute Long Neck Ball

H

HBL	404	2 Flute Ball (Long Shank)
HFB	426	4 Flute Ball
HFB-S	427	4 Flute Ball (Short Shank)
HFTNB	528	3 Flute Taper Neck Ball
HGB	396	2 Flute Ball
HGLB	436	2 Flute Long Neck Ball
HHRS	384	6 Flute Long Neck Radius
HLRS2000	318	2 Flute Long Neck Radius
HLRS4000	338	4 Flute Long Neck Radius
HLRS2000E	318	2 Flute Long Neck Radius (High Radius Accuracy)
HLS2000	230	2 Flute Long Neck Square
HLS4000	276	4 Flute Long Neck Square
HMERS	312	4-6 Flute Radius
HMS	226	3-6 Flute Square

Model Number	Page	Characteristic
--------------	------	----------------

HRRS	362	4 Flute Long Neck Radius
HRRS-S	368	4 Flute Long Neck Radius (Short Shank)
HSB	398	2 Flute Ball (R0.05: Single Flute)
HSB-S	402	2 Flute Ball (Short Shank)
HSLB	446	2 Flute Long Neck Ball
HSLB-S	464	2 Flute Long Neck Ball (Short Shank)
HTNB	508	2 Flute Taper Neck Ball
HTNRS	386	4 Flute Taper Neck Radius

S

SV	542	2 Flute Spiral Chamfering Cutter
----	-----	----------------------------------

U

UDCB	94	2 Flute Ball
UDCBF	80	2 Flute Ball
UDCBH	78	2 Flute Ball
UDCLB	98	2 Flute Long Neck Ball
UDCLBF	82	2 Flute Long Neck Ball
UDCLRS	102	2 Flute Long Neck Radius
UDCLRSF	86	2 Flute Long Neck Radius
UDCMX	108	2 Flute Drill
UDCT	112	2 Flute Thread Mill
UPDLB	434	1 Flute Long Neck Ball
UPDLRS	316	1 Flute Long Neck Radius
UTDF	544	2 Flute UNIMAX Flat Drill
UTDLX	558	2 Flute UNIMAX Drill (Long Flute)
UTDSX	550	2 Flute UNIMAX Drill (Short Flute)

How to find your tool

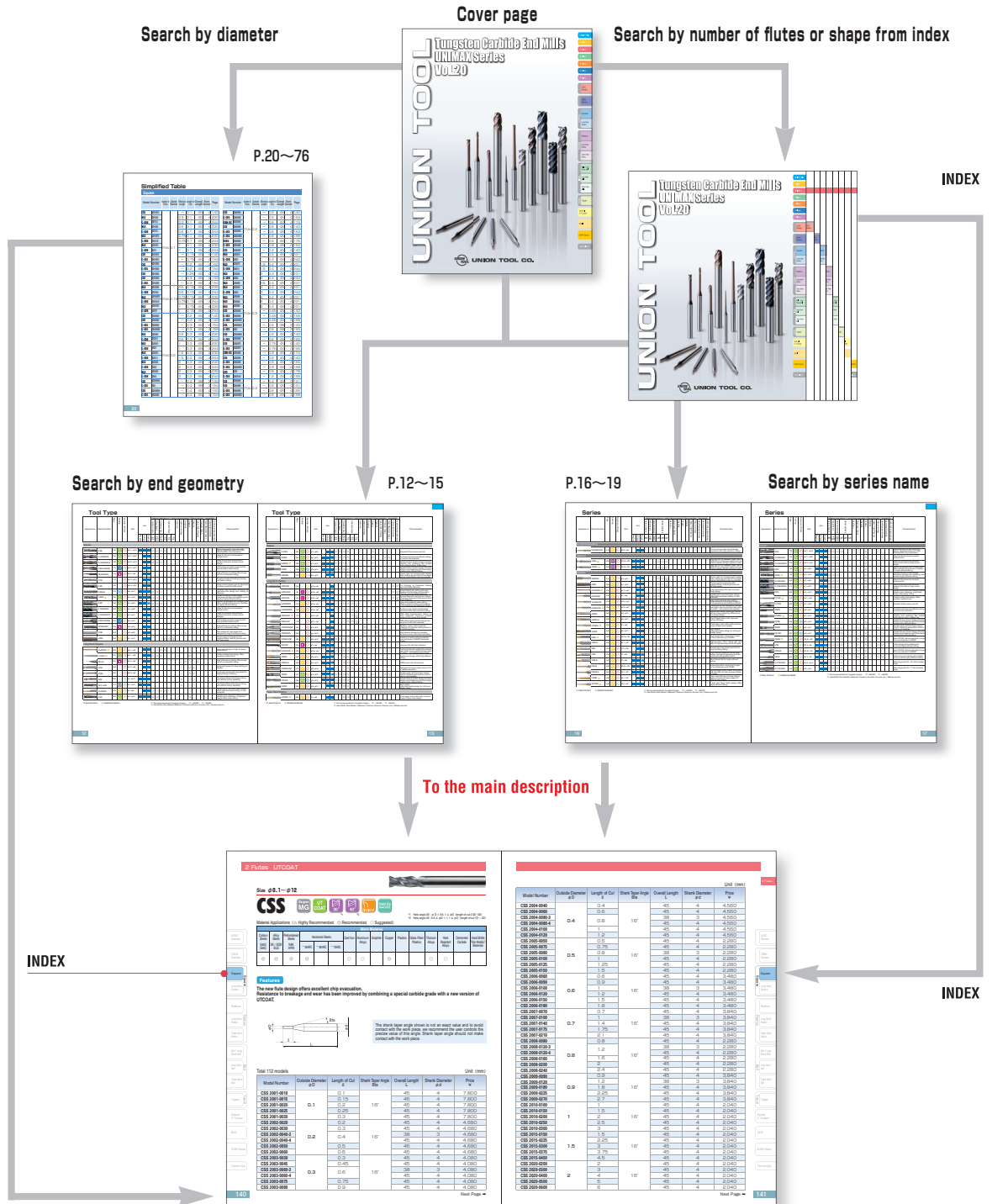

Icon Guide Lines

unit : mm

Tool Material



Super Micro Grain



CBN



Micro Grain



Binderless PCD

Coating



HMG COAT



HARD MAX



UT COAT



UT MICRO COAT



UTS COAT



TiAlN COAT



CrN COAT



UDC



DIA



DLC

Geometry



Corner Radius Design



Back Taper Geometry



Sharp Corner Design



Variable Pitch



Flatland Design



Variable Helix



X Thinning Design

Shank Diameter Tolerance



Tolerance of Shank Diameter : 0/-0.005



Tolerance of Shank Diameter : 0/-0.004

Ball Radius Tolerance



Ball Radius Tolerance : ± 0.002



Ball Radius Tolerance : ± 0.003



Ball Radius Tolerance : ± 0.004



Ball Radius Tolerance : ± 0.005



Ball Radius Tolerance : ± 0.007



Ball Radius Tolerance : ± 0.01

Corner Radius Tolerance



Corner Radius Tolerance : ± 0.002



Corner Radius Tolerance : ± 0.01



Corner Radius Tolerance : ± 0.003



Corner Radius Tolerance : ± 0.015



Corner Radius Tolerance : ± 0.005



Corner Radius Tolerance : ± 0.02

Half Included Angle Tolerance



Half Included Angle Tolerance : $\pm 5'$

Helix Angle



Helix Angle 20°



Helix Angle 42°~45°



Helix Angle 24°



Helix Angle 45°



Helix Angle 25°



Helix Angle 0°



Helix Angle 30°



Helix Angle 20°



Helix Angle 37°~40°



Helix Angle 30°



Helix Angle 40°



Helix Angle 35°



Helix Angle 40°~42°



Helix Angle 40°

Features of Coating

☆Highly Recommended ◎Recommended ○Suggested △Satisfactory

Type	Color	Hardness (HV)	Heat Resistance	Toughness	Lubricant Efficiency	Recommended Use
HMG COAT	Purple-Black	3700-4200	☆	○	◎	for Steels
HARD MAX	Yellow-Gold	3500-4000	☆	○	◎	
UT COAT	Purple-Black	3000-3500	◎	◎	☆	
CrN COAT	Silver White	2000-2200	○	◎	☆	for Copper
UTS COAT	Silver White	3000-3500	◎	◎	☆	for Stainless Steels
DLC	Black	4000-6000	△	△	☆	for Aluminum / Copper / Plastics
DIA	Black	around 9000	△	△	◎	for Graphite
UDC	Black	around 9000	△	○	◎	for Cemented Carbide

How to find best coating for your material applications

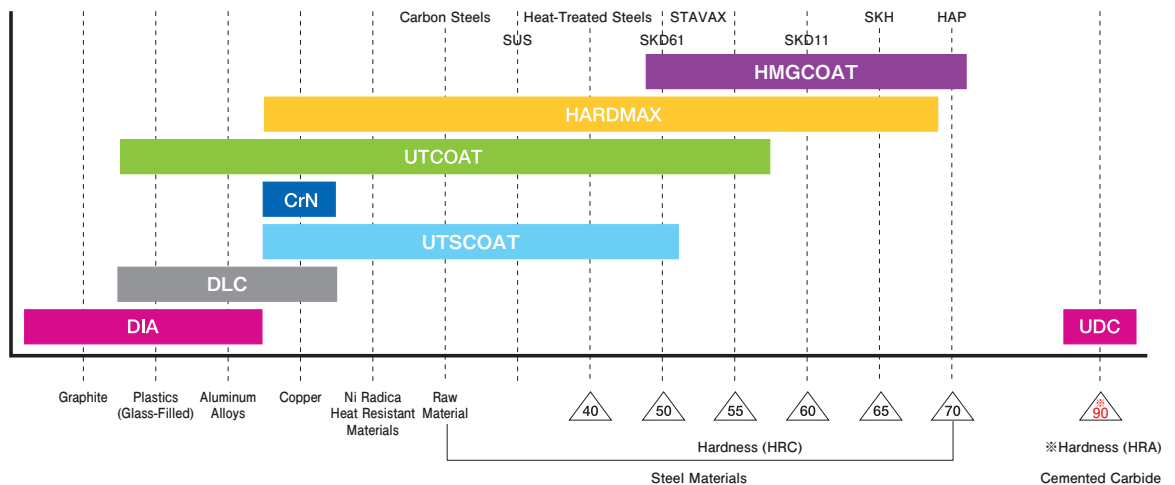



Advisory for Safe Use of UNIMAX Tungsten Carbide End Mills

Correct application and operation is strongly advised to avoid clogging, abrasion, etc, that could cause serious accidents or injuries.

Ignition or sparks generated during milling could lead to fire or extreme damage to the work piece. End Mills are made with very sharp cutting edges and must be handled with extra care.

- Never touch the cutting edge with your bare hands, as this could cause serious injury. Special caution is required when opening the package.
- Dropping the tool could cause breakage or flying debris, leading to serious injury.
- During milling, unexpected impact or shock on the tool could cause breakage or flying debris. Ensure to use protective items such as safety glasses and a face guard.
- For best results, fine parameter adjustment may be required, depending on the materials; milling shape and strategy; machine rigidity and spindle capability.
- Use a machine that has high rigidity and generates a low level of vibration.
- Do not use flammable cutting oils.

Advisory for regrinding UNIMAX Tungsten Carbide End Mills

- Never regrind the tool without wearing safety glasses and a face guard.

NEW PRODUCTS

UDCBH **78** Total 4 models

UDC Diamond coating
2 Flute High-speed Ball End Mills for Cemented Carbide and Hard Brittle Materials



High efficiency and long life Ball End Mills for milling Cemented Carbide. High-level treatment to reduce cutting resistance and mill at a high feed rate. Wear resistance improved drastically with optimized diamond coating. Best for roughing and semi-finishing.

CBN-RSF **126** Total 42 models

CBN 1 Flute Long Neck Radius End Mills for Super Finishing



Optimized CBN material for milling of ultra-hard materials along with excellent wear and chipping resistance ensures long tool life. The unique cutting edge geometry allows for outstanding surface roughness. High precision shank diameter tolerance of 0/-0.004 mm. High precision diameter tolerance of 0/-0.005 mm and corner R accuracy offer super finishing.

DLCLB **488** Total 71 models

DLCCOAT 2 Flute Long Neck Ball End Mills for Copper Electrode Milling



DLC coating offers excellent welding and wear resistance. The flute geometry specially designed for Copper milling offers outstanding tool life. High-precision outside diameter tolerances and radius accuracy measurements are printed on labels to improve machining accuracy. High precision shank diameter tolerance of 0/-0.004 mm.

ADDITIONAL MODELS

CXES 196 Additional 12 models Total 55 models

UTCOAT 4 Flutes Variable Pitch and Variable Helix
Highly Efficient Square End Mills



HLS2000 230 Additional 5 models Total 189 models

HARDMAX 2 Flutes
Long Neck Square End Mills

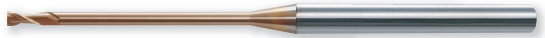

C-CER 244 Additional 10 models Total 148 models

UTCOAT 2 Flutes
Long Neck Square End Mills



CXERS 298 Additional 10 models Total 56 models

UTCOAT 4 Flutes Variable Pitch and Variable Helix
Highly Efficient Radius End Mills



HLRS4000 338 Additional 42 models Total 381 models

HARDMAX 4 Flutes
Long Neck Radius End Mills



HTNRS 386 Additional 28 models Total 111 models

HARDMAX 4 Flutes
Taper Neck Radius End Mills



HGB 396 Additional 2 models Total 20 models

HMGCOAT 2 Flutes for Hard Materials
Ball End Mills



HSB 398 Additional 1 model Total 71 models

HARDMAX 2 Flutes
Ball End Mills



CSEB 406 Additional 1 model Total 78 models

UTCOAT 2 Flutes
Ball End Mills



HGLB 436 Additional 61 models Total 155 models

HMGCOAT 2 Flutes for Hard Materials
Long Neck Ball End Mills



HTNB 508 Additional 48 models Total 245 models

HARDMAX 2 Flutes
Taper Neck Ball End Mills



HFTNB 528 Additional 2 models Total 75 models

HARDMAX 3 Flutes
Taper Neck Ball End Mills



Tool Chart

Square Series

4 Flute High Efficiency Series

CZS 182
4 Flutes which enables even drilling. Patented

CXES/CXS 196 / 282
A wide variety of models Variable Pitch & Helix Series

CESUS 216
Outstandingly high Efficiency for Stainless milling
Variable Pitch & Helix Series

CSS 140
2 Flutes
Offers outstanding tool life by original grooved section.

HMS 226
Achieves highly efficient side milling for ~65HRC!
Suitable for Run-up milling or Trochoid milling as well.

HLS2000 230
2 Flutes

HLS4000 276
4 Flutes

Raw Materials ~ 55HRC Prehardened Steels ~ 65HRC

Hardness

Radius Series

High Efficiency Series

CXRS 308
Optimized for Side Milling. Dramatically high feed rate.
5 Flutes Variable Pitch & Helix

CXLRS 380

High Efficiency Milling

HRRS 362
4 Flutes Variable Pitch & High Helix

HMERS 312
4 Flutes / 6 Flutes

CNRS 294
Optimized flute design and coating for difficult-to-cut materials
4 Flutes Variable Pitch & High Helix

CRRS 370

High-precision Milling

HLRS2000 318
2 Flutes A wide variety of models

HLRS4000 338
4 Flutes Excellent surface quality even on the bottom

Raw Materials ~ 55HRC Prehardened Steels ~ 65HRC

Hardness

Tool Chart

Ball Series

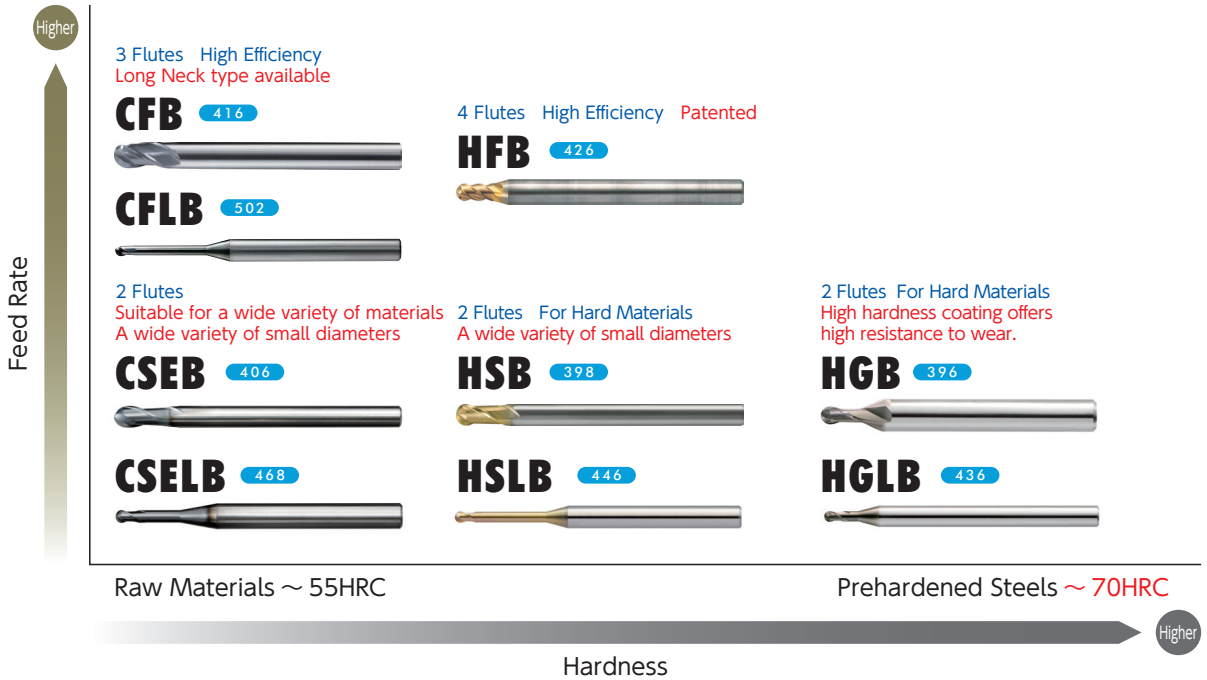

For Cemented Carbide		
Ball	UDCBH (All Flute/2 Flutes)	78
	UDCBF (All Flute/2 Flutes)	80
	UDCB (All Flute/2 Flutes)	94
	UDCLBF (Long Neck/2 Flutes)	82
	UDCLB (Long Neck/2 Flutes)	98
	UPDLB (Long Neck/1 Flute)	434
Radius	UDCLRSF (Long Neck/2 Flutes)	86
	UDCLRS (Long Neck/2 Flutes)	102
	UPDLRS (Long Neck/1 Flute)	316

For Graphite		
Square	DCES2000 (All Flute/2 Flutes)	176
	DCES4000 (All Flute/4 Flutes)	222
	DCLS (Long Neck/2 Flutes)	254
Radius	DCLRS (Long Neck/4 Flutes)	376
Ball	DCB (All Flute/2 Flutes)	412
	DCLB (Long Neck/2 Flutes)	484
	DCTNB (Taper Neck/2 Flutes)	526

For Plastics		
Square	CPS (All Flute/2 Flutes)	178
	CPR (Long Neck/2 Flutes)	258
Ball	CPRL (Long Neck/2 Flutes)	262
	CPRB (Long Neck/2 Flutes)	498

For Heat Resistant Alloys		
Radius	CNRS (All Flute/4 Flutes)	294
	CRRS (Long Neck/4 Flutes)	370
Ball	CFB (All Flute/3 Flutes)	416
	CFLB (Long Neck/3 Flutes)	502

For Aluminum Alloys		
Square (Finishing)	CAS (All Flute/2 Flutes)	180
Square (Efficiency)	AZS/ DLC-AZS (Long Neck/3 Flutes)	266
Ball	DLC-CFB (All Flute/3 Flutes)	422

For Copper		
Square	CRN-ES2000 (All Flute/2 Flutes)	174
	CRN-ES4000 (All Flute/4 Flutes)	220
Ball	DLCLB (Long Neck/2 Flutes)	488

Tool Type

Appearance	Model Number	Page	Coating	Number of Flutes	Size	Use	Material Applications (☆ Highly Recommended ◎ Recommended ○ Suggested)														Characteristics					
							Carbon Steels		Alloy Steels		Prehardened Steels		Hardened Steels			Cast Iron	Aluminum Alloys	Graphite	Copper	Plastics		Glass Filled Plastics	Titanium Alloys	Heat Resistant Alloys	Cemented Carbide	Hard Brittle (Non-Metallic) Materials
							S2	S3	S4	S5	S6	S7	S8	S9	~52 HRC											
Square																										
	CSS	140	UT COAT	2	φ0.1~φ12																Recommended for part and mold milling. Upgraded series of C-CES offering better chip evacuation.					
	C-CES2000	154	UT COAT	2	φ0.1~φ20																Value for the price and excellent surface finish.					
	C-CES2000S	168	UT COAT	2	φ0.2~φ12																Value for the price and excellent surface finish with a sharp corner design.					
	CRN-ES2000	174	CrN COAT	2	φ0.2~φ12																CrN coating provides longer tool life and excellent surface finish.					
	DCES2000	176	DIA	2	φ0.2~φ6																High adherence coating offers longer tool life on Graphite milling.					
	CPS	178	-	2	φ0.3~φ12																Provides excellent finishing accuracy on Plastics milling.					
	CAS	180	-	2	φ0.5~φ12																Sharp corner square type for Aluminum provides excellent surface finish.					
	CESUS	216	UTS COAT	4	φ6~φ12																Achieves high efficiency milling by the optimized tool design and coating for Stainless.					
	CXES	196	UT COAT	4	φ1~φ16																Variable Division & Helix design minimizes vibration and chattering and enables highly efficient milling.					
	CZS	182	UT COAT	4	φ1~φ20																Special tip geometry with variable pitch offers vertical milling function. Suitable for highly efficient milling.					
	C-CES4000	208	UT COAT	4	φ1~φ20																Value for the price and excellent surface finish.					
	C-CES4000S	214	UT COAT	4	φ1~φ12																Value for the price and excellent surface finish with a sharp corner design.					
	CRN-ES4000	220	CrN COAT	4	φ3~φ12																CrN coating provides longer tool life and excellent surface finish.					
	DCES4000	222	DIA	4	φ3~φ10																High adherence coating offers longer tool life on Graphite milling.					
	CGE	224	-	4	φ2~φ20																Non-coated 45° helix angle tool designed for high finishing accuracy.					
	HMS	226	HARD MAX	3, 4	φ1~φ12																Precise rigid tool designed with negative flutes, shallow grooves and 45° helix angle.					
Long Neck Square																										
	HLS2000	230	HARD MAX	2	φ0.1~φ6																Long neck square for high accuracy deep milling.					
	C-CER	244	UT COAT	2	φ0.1~φ6																Positive cutting flute design offers excellent surface finish.					
	DCLS	254	DIA	2	φ0.4~φ6																High adherence coating offers longer tool life on Graphite milling.					
	CPR	258	-	2	φ0.5~φ6																Long neck square for deep slotting on Plastics.					
	CPRL	262	-	2	φ0.5~φ4																Long neck square with long shank for deep slotting on Plastics.					
	AZS	266	-	3	φ1~φ12																For Highly efficient Aluminum milling with vertical milling capability.					
	DLC-AZS	270	DLC	3	φ1~φ12																For Highly efficient Aluminum milling with vertical milling capability.					
	HLS4000	276	HARD MAX	4	φ1~φ6																Variable pitch and back taper design offers high feed deep milling on hard materials.					
	CXS	282	UT COAT	4	φ1~φ12																Variable pitch and helix design controls vibration and chattering. Long Neck design offers deep milling.					

● New Product ● Additional Model

*1 Not recommended for Tungsten Copper. *2 ~65HRC *3 ~68HRC

*4 Hard Brittle (Non-Metallic) Materials: Ceramics (Alumina, Zirconia, etc.), Glasses and etc.

Tool Type

Appearance	Model Number	Page	Coating	Number of Flutes	Size	Use		Material Applications (☆ Highly Recommended ◎ Recommended ○ Suggested)											Characteristics
						Roughing	Finishing	Carbon Steels	Alloy Steels	Prehardened Steels	Hardened Steels	Cast Iron	Aluminum Alloys	Graphite	Copper	Plastics	Glass Filled Plastics	Titanium Alloys	

Radius																	
	C-CRS	290	UT COAT	2	φ1~φ20			◎	◎	◎	◎						Standard 2 flute radius end mill.
	CNRS	294	UT COAT	4	φ6~φ12			◎	◎	◎	◎						Provides high feed and efficient milling on hard-to-cut materials.
	CXERS	298	UT COAT	4	φ1~φ12			◎	◎	◎	◎						Variable Division & Helix design minimizes vibration and chattering and enables highly efficient milling. Radius type.
	CXRS	308	UT COAT	5	φ3~φ12			◎	◎	◎	◎						Variable Division & Helix design minimizes vibration and chattering and 5 flute design enables highly efficient milling.
	HMERS	312	HARD MAX	4/6	φ3~φ12							◎	◎	◎	◎		Precise rigid tool designed with negative flutes, shallow grooves and 45° helix angle. Various Corner Radius sizes are available.

Long Neck Radius																	
	UPDLRS	316	-	1	φ0.2~φ2											☆ ◎	For Finishing on Cemented Carbide and Hard Brittle Materials.
	UDCLRSF	86	UDC	2	φ0.3~φ2											☆ ◎	Special Diamond coating and edge treatment for finishing on Cemented Carbide and Hard Brittle Materials.
	UDCLRS	102	UDC	2	φ0.3~φ2											☆ ◎	Special Diamond coat and tool design for milling Cemented Carbide and Hard Brittle Materials.
	HLRS2000	318	HARD MAX	2	φ0.4~φ6			◎	◎	◎	◎	◎	◎	◎	◎		Long neck radius for deep milling. Offers excellent finishing performance on Prehardened and Hardened Steels.
	HLRS2000E	318	HARD MAX	2	φ0.2~φ6			◎	◎	◎	◎	◎	◎	◎	◎		Precise corner radius and diameter tolerances offer high precision milling.
	CBN-RSF	126	-	1	φ0.2~φ2							◎	◎	◎	◎		CBN offers high-precision milling on hard materials. Improves product quality by the unique flute design.
	CBN-LRF	132	-	2	φ0.1~φ2							◎	◎	◎	◎		CBN offers high-precision milling and long tool life for hard materials.
	CPRS25NSP	564	-	2	φ2~φ12									◎	◎		Miniature corner radius prevents chipping and reduces cutting marks on the milling surface.
	CPRS30N	566	-	2	φ4~φ10									◎	◎		Well balanced design for excellent surface accuracy and chip evacuation.
	CRS40HSP	568	HARD MAX	3	φ2~φ12			◎	◎	◎	◎			◎	◎		Suitable for milling various materials from soft steels to 60HRC Hardened Steels.
	DCLRS	376	DIA	4	φ1~φ6										☆ ◎		Long tool life with high adhesion.
	HLRS4000	338	HARD MAX	4	φ0.2~φ6			◎	◎	◎	◎	◎	◎	◎	◎		Precise rigid tool with variable pitch and back taper design. Recommended for deep milling on middle ~ hard materials with high feed.
	HRRS	362	HARD MAX	4	φ2~φ12					◎	◎	◎	◎	◎	◎		Special tool design offers high efficient milling.
	HRRS-S	368	HARD MAX	4	φ2~φ12					◎	◎	◎	◎	◎	◎		HRRS series with short shank.
	CRS20HSP	570	HARD MAX	4	φ2~φ12			◎	◎	◎	◎			◎			Designed the corner radius size as 10% of outside diameter.
	CRRS	370	UT COAT	4	φ2~φ12			◎	◎	◎	◎			◎	◎		Variable pitch and back taper design control chattering and perform well on hard-to-cut materials.
	CXLRS	380	UT COAT	5	φ3~φ12			◎	◎	◎	◎			◎	◎		Variable Division & Helix design minimizes vibration and chattering and 5 flute design enables highly efficient milling.
	HHRSS	384	HARD MAX	6	φ6~φ12			◎	◎	◎	◎			◎	◎		High rigidity. Long neck radius design for milling on Harder Steels.

Taper Neck Radius																	
	HTNRS	386	HARD MAX	4	φ1~φ6					◎	◎	◎	◎	◎	◎		4 flute taper neck radius with a various lineup of taper neck angles.

● New Product ● Additional Model *1 Not recommended for Tungsten Copper. *2 ~65HRC *3 ~68HRC *4 Hard Brittle (Non-Metallic) Materials: Ceramics (Alumina, Zirconia, etc.), Glasses and etc.

Tool Type

Appearance	Model Number	Page	Coating	Number of Flutes	Size	Material Applications (☆ Highly Recommended ◎ Recommended ○ Suggested)													Characteristics							
						Use			Carbon Steels	Alloy Steels	Prehardened Steels		Hardened Steels			Cast Iron	Aluminum Alloys	Graphite		Copper	Plastics	Glass Filled Plastics	Titanium Alloys	Heat Resistant Alloys	Cemented Carbide	Hard Brittle (Non-Metallic) Materials
						Roughing	Semi-finishing	Finishing			50-55 HRC	55-58 HRC	58-62 HRC	62-65 HRC	65-70 HRC											

Ball																							
	UDCBH	78	UDC	2	R0.4~R1																	☆ ◎ *4	The improved Diamond coating and new edge treatment enable high feed rate milling.
	UDCBF	80	UDC	2	R0.1~R3																	☆ ◎ *4	Special Diamond coating and edge treatment for finishing on Cemented Carbide and Hard Brittle Materials.
	UDCB	94	UDC	2	R0.1~R3																	☆ ◎ *4	Special Diamond coating and tool design for milling Cemented Carbide and Hard Brittle Materials.
	HGB	396	HMG COAT	2	R0.05~R3																		Long tool life on Hardened Steels due to HMGCOAT for milling hard materials and new carbide materials with high resistance to wear.
	HSB	398	HARD MAX	2	R0.03~R6																		Broad application range from Copper to hard materials up to 70HRC.
	HSB-S	402	HARD MAX	2	R0.1~R2																		High-accuracy Short Shank Ball End Mills for long overhang milling.
	HBL	404	HARD MAX	2	R1.5~R6																		Straight type long shank end mills for long overhang milling.
	CSEB	406	UT COAT	2	R0.05~R6																		New UTCOAT. Broad application range from raw materials to 55HRC.
	DCB	412	DIA	2	R0.5~R6																		Long tool life with high-adhesion coating.
	CGB2000	414	-	2	R0.2~R6																		Non-coated sharp cutting edge design for excellent finish.
	CFB	416	UT COAT	3	R0.3~R6																		3 flute design with variable pitch promotes high efficient milling.
	DLC-CFB	422	DLC	3	R0.3~R6																		DLC coating offers longer tool life for Aluminum milling. Highly efficient milling by 3 flute design.
	HFB	426	HARD MAX	4	R1~R6																		Rigid tool with negative cutting edge design. Special tip geometry provides enhanced cutting performance.
	HFB-S	427	HARD MAX	4	R1~R6																		Short Shank Ball for highly efficient milling.
	CGB4000	432	-	4	R2~R10																		Non-coated sharp cutting edge design for excellent finish. 4 flute design offers high feed.

Long Neck Ball																							
	UPDLB	434	-	1	R0.1~R1																	☆ ◎	For finishing on Cemented Carbide and Hard Brittle Materials.
	UDCLBF	82	UDC	2	R0.1~R3																	☆ ◎ *4	Special Diamond coating and edge treatment for finishing on Cemented Carbide and Hard Brittle Materials.
	UDCLB	98	UDC	2	R0.1~R3																	☆ ◎ *4	Special Diamond coat and tool design for milling Cemented Carbide and Hard Brittle Materials.
	HGLB	436	HMG COAT	2	R0.05~R3																		Long tool life on Hardened Steels due to HMGCOAT for milling hard materials and new carbide materials with high resistance to wear.
	HSLB	446	HARD MAX	2	R0.05~R3																		Broad application range from Copper to hard materials up to 70HRC.
	HSLB-S	464	HARD MAX	2	R0.1~R3																		High-accuracy Short Shank Long Neck Ball End Mills for high-accuracy shrink-fit holder.
	CSELB	468	UT COAT	2	R0.05~R3																		New UTCOAT. Broad application range from raw materials to 55HRC.
	DCLB	484	DIA	2	R0.2~R3																		Long tool life with high-adhesion coating.
	DLCLB	488	DLC	2	R0.05~R3																		The optimized flute geometry and DLC coating offer long tool life and high-precision milling.
	CBN-LBSF	114	-	2	R0.05~R1																		CBN offers high-precision milling and long tool life for hard materials. Improves product quality by the unique flute design.
	CBN-LBF	120	-	2	R0.05~R1																		CBN offers high-precision milling and long tool life for hard materials.
	CPRB	498	-	2	R0.2~R3																		Long neck ball for deep slotting on Plastics.
	CFLB	502	UT COAT	3	R0.3~R3																		3 flute long neck design with variable pitch promotes highly efficient milling.

● New Product ● Additional Model *1 Not recommended for Tungsten Copper. *2 ~65HRC *3 ~68HRC
 *4 Hard Brittle (Non-Metallic) Materials: Ceramics (Alumina, Zirconia, etc.), Glasses and etc.

Tool Type

Appearance	Model Number	Page	Coating	Number of Flutes	Size	Use	Material Applications (☆ Highly Recommended ◎ Recommended ○ Suggested)													Characteristics		
							Carbon Steels	Alloy Steels	Pretreated Steels	Hardened Steels		Cast Iron	Aluminum Alloys	Graphite	Copper	Plastics	Glass Filled Plastics	Titanium Alloys	Heat Resistant Alloys		Cemented Carbide	Hard Brittle (Non-Metallic) Materials
										SC52	SC55											

Taper Neck Ball

	HTNB	508	HARD MAX	2	R0.1~R2																			Taper neck ball type for deep milling. Various choices on taper angles for different wall angles.
	DCTNB	526	DIA	2	R0.5~R1																			○ Diamond coating offers longer tool life for Graphite milling.
	HFTNB	528	HARD MAX	3	R0.5~R2																			3 flute and Taper Neck design offers highly efficient milling.

Taper

	C-CTE2000	534	UT COAT	2	φ0.2~φ2.5																			Wide range with 30°~15° half included angle.
	C-CTE4000	538	UT COAT	4	φ3~φ10																			Wide range with 30°~7° half included angle.

Chamfering

	SV	542	-	2	φ3~φ12																			Spiral peripheral cutting edge offers excellent chamfering.
--	----	-----	---	---	--------	--	--	--	--	--	--	--	--	--	--	--	--	--	--	--	--	--	--	---























Drill and Thread Mill

	UDCMX	108	UDC	2	φ0.3~φ7																			☆ ◎ *4	Special Diamond coated tool for drilling Cemented Carbide and Hard Brittle materials.
	UDCT	112	UDC	2	M2~M8																			☆ ◎ *4	Thread Mills for Cemented Carbide and Hard Brittle materials.
	UTDF	544	UT COAT	2	φ2~φ12																				A point angle of 180° offers the unique possibility for pilot hole drilling.
	UTDSX	550	MICRO COAT	2	φ0.3~φ2																				Coated carbide drills with short flute length. "X" thinning design provides excellent hole accuracy.
	C-UMD	552	MICRO COAT	2	φ0.1~φ6																				Carbide drills with wide range of sizes.
	UTDLX	558	MICRO COAT	2	φ0.3~φ3																				Coated carbide drills with long flute length. "X" thinning design provides excellent hole accuracy.

● New Product ● Additional Model

*1 Not recommended for Tungsten Copper. *2 ~65HRC *3 ~68HRC
*4 Hard Brittle (Non-Metallic) Materials: Ceramics (Alumina, Zirconia, etc.), Glasses and etc.

Series





















Appearance	Model Number	Page	Coating	Number of Flutes	Size	Use		Material Applications (☆ Highly Recommended ◎ Recommended ○ Suggested)											Characteristics				
						Roughing	Finishing	Carbon Steels	Alloy Steels	Prehardened Steels	Hardened Steels		Cast Iron	Aluminum Alloys	Graphite	Copper	Plastics	Glass Filled Plastics		Titanium Alloys	Heat Resistant Alloys	Cemented Carbide	Hard Brittle (Non-Metallic) Materials
For High Precision Milling																							
	HLRS2000E	318	HARD MAX	2	φ0.2~φ6																		Precise corner radius and diameter tolerances offer high precision milling.
HMGC0AT																							
	HGB	396	HMGC0AT	2	R0.05~R3																		Long tool life on Hardened Steels due to HMGC0AT for milling hard materials and new carbide materials with high resistance to wear.
	HGLB	436	HMGC0AT	2	R0.05~R3																		Long tool life on Hardened Steels due to HMGC0AT for milling hard materials and new carbide materials with high resistance to wear.
HARDMAX																							
	HMERS	312	HARD MAX	4 6	φ3~φ12																		Precise rigid tool designed with negative flutes, shallow grooves and 45° helix angle. Various Corner Radius sizes are available.
	HMS	226	HARD MAX	3 4 6	φ1~φ12																		Precise rigid tool designed with negative flutes, shallow grooves and 45° helix angle.
	HLS2000	230	HARD MAX	2	φ0.1~φ6																		Long neck square for high accuracy deep milling.
	HLS4000	276	HARD MAX	4	φ1~φ6																		Variable pitch and back taper design offers high feed deep milling on hard materials.
	HLRS2000	318	HARD MAX	2	φ0.4~φ6																		Long neck radius for deep milling. Offers excellent finishing performance on Prehardened and Hardened Steels.
	HLRS4000	338	HARD MAX	4	φ0.2~φ6																		Precise rigid tool with variable pitch and back taper design. Recommended for deep milling on middle ~ hard materials with high feed.
	HRRS	362	HARD MAX	4	φ2~φ12																		Special tool design offers high efficient milling. Improved milling efficiency by the unique design.
	HRRS-S	368	HARD MAX	4	φ2~φ12																		Short Shank Radius with improved milling efficiency.
	HTNRS	386	HARD MAX	4	φ1~φ6																		4 flute taper neck radius with a various lineup of taper neck angles.
	HHRS	384	HARD MAX	6	φ6~φ12																		High rigidity. Long neck radius design for milling on Harder Steels.
	HSB	398	HARD MAX	2	R0.03~R6																		Broad application range from Copper to hard materials up to 70HRC.
	HSB-S	402	HARD MAX	2	R0.1~R2																		High-accuracy Short Shank Ball End Mills for high-accuracy shrink-fit holder.
	HBL	404	HARD MAX	2	R1.5~R6																		Straight type long shank end mills for long overhang milling.
	HFB	426	HARD MAX	4	R1~R6																		Rigid tool with negative cutting edge design. Special tip geometry provides enhanced cutting performance.
	HFB-S	427	HARD MAX	4	R1~R6																		Short Shank Ball for highly efficient milling.
	HSLB	446	HARD MAX	2	R0.05~R3																		Broad application range from Copper to hard materials up to 70HRC.
	HSLB-S	464	HARD MAX	2	R0.1~R3																		High-accuracy Short Shank Long Neck Ball End Mills for high-accuracy shrink-fit holder.
	HTNB	508	HARD MAX	2	R0.1~R2																		Taper neck ball type for deep milling. Various choices on taper angles for different wall angles.
	HFTNB	528	HARD MAX	3	R0.5~R2																		3 flute and Taper Neck design offers highly efficient milling.

● New Product ● Additional Model

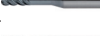
*1 Not recommended for Tungsten Copper. *2 ~65HRC *3 ~68HRC
*4 Hard Brittle (Non-Metallic) Materials: Ceramics (Alumina, Zirconia, etc.), Glasses and etc.

Series

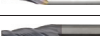
Appearance	Model Number	Page	Coating	Number of Flutes	Size	Material Applications (☆ Highly Recommended ◎ Recommended ○ Suggested)													Characteristics						
						Use			Carbon Steels	Alloy Steels	Prehardened Steels	Hardened Steels			Cast Iron	Aluminum Alloys	Graphite	Copper		Plastics	Glass Filled Plastics	Titanium Alloys	Heat Resistant Alloys	Cemented Carbide	Hard Brittle (Non-Metallic) Materials
						Roughing	Semi-finishing	Finishing	3C 3C2 3C3	3C 3C2 3C3	3C 3C2 3C3	30-40 HRC	45-55 HRC	55-60 HRC	60-70 HRC										

UTCOAT																					
	CSS	140	UT COAT	2	φ0.1~φ12																Recommended for part and mold milling. Upgraded series of C-CES offering better chip evacuation.
	C-CES2000	154	UT COAT	2	φ0.1~φ20																Value for the price and excellent surface finish.
	C-CES2000S	168	UT COAT	2	φ0.2~φ12																Value for the price and excellent surface finish with a sharp corner design.
	CZS	182	UT COAT	4	φ1~φ20																Special tip geometry with variable pitch offers vertical milling function. Suitable for highly efficient milling.
	CXES	196	UT COAT	4	φ1~φ16																Variable Division & Helix design minimizes vibration and chattering and enables highly efficient milling.
	C-CES4000	208	UT COAT	4	φ1~φ20																Value for the price and excellent surface finish.
	C-CES4000S	214	UT COAT	4	φ1~φ12																Value for the price and excellent surface finish with a sharp corner design.
	CXS	282	UT COAT	4	φ1~φ12																Variable pitch and helix design controls vibration and chattering. Long Neck design offers deep milling.
	C-CER	244	UT COAT	2	φ0.1~φ6																Positive cutting flute design offers excellent surface finish.
	C-CRS	290	UT COAT	2	φ1~φ20																Standard 2 flute radius end mill.
	CNRS	294	UT COAT	4	φ6~φ12														☆ ☆		Provides high feed and efficient milling on hard-to-cut materials.
	CXERS	298	UT COAT	4	φ1~φ12																Variable Division & Helix design minimizes vibration and chattering and enables highly efficient milling. Radius type.
	CXRS	308	UT COAT	5	φ3~φ12																Variable Division & Helix design minimizes vibration and chattering and 5 flute design enables highly efficient milling.
	CRRS	370	UT COAT	4	φ2~φ12																Variable pitch and back taper design control chattering and perform well on hard-to-cut materials.
	CXLRS	380	UT COAT	5	φ3~φ12																Variable Division & Helix design minimizes vibration and chattering and 5 flute design enables highly efficient milling.
	CSEB	406	UT COAT	2	R0.05~R6																New UTCOAT. Broad application range from raw materials to 55HRC.
	CFB	416	UT COAT	3	R0.3~R6																3 flute design with variable pitch promotes highly efficient milling.
	CSELB	406	UT COAT	2	R0.05~R3																New UTCOAT. Broad application range from raw materials to 55HRC.
	CFLB	502	UT COAT	3	R0.3~R3																3 flute long neck design with variable pitch promotes highly efficient milling.
	C-CTE2000	534	UT COAT	2	φ0.2~φ2.5																Wide range with 30°~15° half included angle.
	C-CTE4000	538	UT COAT	4	φ3~φ10																Wide range with 30°~7° half included angle.

● New Product ● Additional Model

*1 Not recommended for Tungsten Copper. *2 ~65HRC *3 ~68HRC

*4 Hard Brittle (Non-Metallic) Materials: Ceramics (Alumina, Zirconia, etc.), Glasses and etc.

Series

Appearance	Model Number	Page	Coating	Number of Flutes	Size	Material Applications (☆ Highly Recommended ◎ Recommended ○ Suggested)													Characteristics					
						Use			Carbon Steels	Alloy Steels	Prehardened Steels	Hardened Steels			Cast Iron	Aluminum Alloys	Graphite	Copper		Plastics	Glass Filled Plastics	Titanium Alloys	Heat Resistant Alloys	Cemented Carbide
						Roughing	Semi-finishing	Finishing	SC	SCS	SCS2	5% M2	5% S7	5% S7	5% S7	5% S7	5% S7	5% S7	5% S7	5% S7	5% S7	5% S7	5% S7	5% S7

For Cemented Carbide and Hard Brittle Materials Milling

	UDCBH	78	UDC	②	R0.4~R1																				☆	◎*4	The improved Diamond coating and new edge treatment enable high feed rate milling.
	UDCBF	80	UDC	②	R0.1~R3																				☆	◎*4	Special Diamond coating and edge treatment for finishing on Cemented Carbide and Hard Brittle Materials.
	UDCLBF	82	UDC	②	R0.1~R3																				☆	◎*4	Special Diamond coating and edge treatment for finishing on Cemented Carbide and Hard Brittle Materials.
	UDCLRSF	86	UDC	②	φ0.3~φ2																				☆	◎*4	Special Diamond coating and edge treatment for finishing on Cemented Carbide and Hard Brittle Materials.
	UDCB	94	UDC	②	R0.1~R3																				☆	◎*4	Special Diamond coating and tool design for milling Cemented Carbide and Hard Brittle Materials.
	UDCLB	98	UDC	②	R0.1~R3																				☆	◎*4	Special Diamond coating and tool design for milling Cemented Carbide and Hard Brittle Materials.
	UDCLRS	102	UDC	②	φ0.3~φ2																				☆	◎*4	Special Diamond coating and tool design for milling Cemented Carbide and Hard Brittle Materials.
	UDCMX	108	UDC	②	φ0.3~φ7																				☆	◎*4	Special Diamond coating and tool design for milling Cemented Carbide and Hard Brittle Materials.
	UDCT	112	UDC	②	M2~M8																				☆	◎*4	Thread Mills for Cemented Carbide and Hard Brittle materials.

For finishing on Cemented Carbide and Hard Brittle Materials

	UPDLRS	316	-	①	φ0.2~φ2																				☆	◎	For finishing on Cemented Carbide and Hard Brittle Materials.
	UPDLB	434	-	①	R0.1~R1																				☆	◎	For finishing on Cemented Carbide and Hard Brittle Materials.

CBN

	CBN-RSF	126	-	①	φ0.2~φ2																						CBN offers high-precision milling on hard materials. Improves product quality by the unique flute design.
	CBN-LRF	132	-	②	φ0.1~φ2																						CBN offers high-precision milling and long tool life.
	CBN-LBSF	114	-	②	R0.05~R1																						CBN offers high-precision milling and long tool life for hard materials. Improves product quality by the unique flute design.
	CBN-LBF	120	-	②	R0.05~R1																						CBN offers high-precision milling and long tool life for hard materials.

For Stainless Steel Milling

	CESUS	216	ALTiS COAT	④	φ6~φ12																						Achieves high efficiency milling by the optimized tool design and coating for Stainless.
--	-------	-----	------------	---	--------	--	--	--	--	--	--	--	--	--	--	--	--	--	--	--	--	--	--	--	--	--	--

For Copper Electrode Milling

	CRN-ES2000	174	CrN COAT	②	φ0.2~φ12																						CrN coating provides longer tool life and excellent surface finish.
	CRN-ES4000	220	CrN COAT	④	φ3~φ12																						CrN coating provides longer tool life and excellent surface finish.
	DLCLB	488	DLC	②	R0.05~R3																						The optimized flute geometry and DLC coating offer long tool life and high-precision milling.

For Aluminum Milling

	CAS	180	-	②	φ0.5~φ12																						Sharp corner square type for Aluminum provides excellent surface finish.
	AZS	266	-	③	φ1~φ12																						For Highly efficient Aluminum milling with vertical milling capability.
	DLC-AZS	270	DLC	③	φ1~φ12																						For Highly efficient Aluminum milling with vertical milling capability.
	DLC-CFB	422	DLC	③	R0.3~R6																						DLC coating offers longer tool life for Aluminum milling. Highly efficient milling by 3 flute design.

● New Product ● Additional Model





*1 Not recommended for Tungsten Copper. *2 ~65HRC *3 ~68HRC

*4 Hard Brittle (Non-Metallic) Materials: Ceramics (Alumina, Zirconia, etc.), Glasses and etc.











Series

Appearance	Model Number	Page	Coating	Number of Flutes	Size	Material Applications (☆ Highly Recommended ◎ Recommended ○ Suggested)											Characteristics					
						Use			Carbon Steels	Alloy Steels	Prehardened Steels	Hardened Steels			Cast Iron	Aluminum Alloys		Graphite	Copper	Plastics	Glass Filled Plastics	Titanium Alloys
						Roughing	Semi-finishing	Finishing	SUS	SCM	SUS	50~55 HRC	55~58 HRC	58~60 HRC	~70 HRC							

For Plastic Milling

	CPS	178	-	②	φ0.3~φ12																					Provides excellent finishing accuracy on Plastics milling.
	CPR	258	-	②	φ0.5~φ6																					Long neck square for deep slotting on Plastics.
	CPRL	262	-	②	φ0.5~φ4																					Long neck square with long shank for deep slotting.
	CPRB	498	-	②	R0.2~R3																					Long neck ball for deep slotting on Plastics.





For Graphite Milling

	DCES2000	176	DIA	②	φ0.2~φ6																					Long tool life with high-adhesion coating
	DCES4000	222	DIA	④	φ3~φ10																					Long tool life with high-adhesion coating
	DCLS	254	DIA	②	φ0.4~φ6																					Long tool life with high-adhesion coating
	DCLRS	376	DIA	④	φ1~φ6																					Long tool life with high-adhesion coating
	DCB	412	DIA	②	R0.5~R6																					Long tool life with high-adhesion coating
	DCLB	484	DIA	②	R0.2~R3																					Long tool life with high-adhesion coating
	CGE	224	-	④	φ2~φ20																					Non-coated 45° helix angle tool designed for high finishing accuracy.
	DCTNB	526	DIA	②	R0.5~R1																					Diamond coating offers longer tool life for Graphite milling.
	CGB2000	414	-	②	R0.2~R6																					Non-coated sharp cutting edge design for excellent finish.
	CGB4000	432	-	④	R2~R10																					Non-coated sharp cutting edge design for excellent finish.





Spiral Chamfering Cutter

	SV	542	-	②	φ3~φ12																					Spiral peripheral cutting edge offers excellent chamfering.
--	----	-----	---	---	--------	--	--	--	--	--	--	--	--	--	--	--	--	--	--	--	--	--	--	--	--	---

UNIMAX Drill

	UTDF	544	UT COAT	②	φ2~φ12																					A point angle of 180° offers the unique possibility for pilot hole drilling.
	UTDSX	550	MICRO COAT	②	φ0.3~φ2																					Coated carbide drills with short flute length. "X" thinning design provides excellent hole accuracy.
	C-UMD	552	MICRO COAT	②	φ0.1~φ6																					Carbide drills with wide range of sizes.
	UTDLX	558	MICRO COAT	②	φ0.3~φ3																					Coated carbide drills with long flute length. "X" thinning design provides excellent hole accuracy.

EURO Series

	CPRS25NSP	564	-	②	φ2~φ12																					Miniature corner radius prevents chipping and reduces cutting marks on the milling surface.
	CPRS30N	566	-	②	φ4~φ10																					Well balanced design for excellent surface accuracy and chip evacuation.
	CRS40HSP	568	HARD MAX	③	φ2~φ12																					Suitable for milling various materials from soft steels to 60HRC Hardened Steels.
	CRS20HSP	570	HARD MAX	④	φ2~φ12																					Designed the corner radius size as 10% of outside diameter.

● New Product ● Additional Model

*1 Not recommended for Tungsten Copper. *2 ~65HRC *3 ~68HRC
*4 Hard Brittle (Non-Metallic) Materials: Ceramics (Alumina, Zirconia, etc.), Glasses and etc.

Simplified Table

Square									
Model Number	Number of Flutes	Outside Diameter	Effective Length	Length of Cut	Overall Length	Shank Diameter	Page		
CSS 2001-0010	2 Flutes	0.1	—	0.1	45	4	140		
HLS 2001-003			0.3	0.1	45	4	230		
C-CER 2001-0.3			0.3	0.1	45	4	244		
HLS 2001-005			0.5	0.1	45	4	230		
C-CER 2001-0.5			0.5	0.1	45	4	244		
HLS 2001-0075			0.75	0.1	45	4	230		
C-CER 2001-0.75			0.75	0.1	45	4	244		
HLS 2001-010			1	0.1	45	4	230		
C-CER 2001-1			1	0.1	45	4	244		
CSS 2001-0015			—	0.15	45	4	140		
C-CES 2001-0015			—	0.15	45	4	154		
CSS 2001-0020			—	0.2	45	4	140		
C-CES 2001-0020			—	0.2	45	4	154		
CSS 2001-0025			—	0.25	45	4	140		
CSS 2001-0030			—	0.3	45	4	140		
C-CES 2001-0030			—	0.3	45	4	154		
HLS 20015-005			2 Flutes	0.15	0.5	0.15	45	4	230
C-CER 20015-0.5					0.5	0.15	45	4	244
HLS 20015-0075					0.75	0.15	45	4	230
C-CER 20015-0.75					0.75	0.15	45	4	244
HLS 20015-010	1	0.15			45	4	230		
C-CER 20015-1	1	0.15			45	4	244		
CSS 2002-0020	2 Flutes	0.2	—	0.2	45	4	140		
CSS 2002-0030			—	0.3	45	4	140		
C-CES 2002-0030			—	0.3	45	4	154		
C-CES 2002-0030S			—	0.3	45	4	168		
HLS 2002-005			0.5	0.3	45	4	230		
C-CER 2002-0.5			0.5	0.3	45	4	244		
HLS 2002-010			1	0.3	45	4	230		
C-CER 2002-1			1	0.3	45	4	244		
HLS 2002-015			1.5	0.3	45	4	230		
C-CER 2002-1.5			1.5	0.3	45	4	244		
HLS 2002-020			2	0.3	45	4	230		
C-CER 2002-2			2	0.3	45	4	244		
HLS 2002-030			3	0.3	45	4	230		
C-CER 2002-3			3	0.3	45	4	244		
CSS 2002-0040-3			—	0.4	38	3	140		
C-CES 2002			—	0.4	38	3	154		
CSS 2002-0040-4			—	0.4	45	4	140		
C-CES 2002-0040			—	0.4	45	4	154		
CSS 2002-0050			2 Flutes	0.2	—	0.5	45	4	140
C-CES 2002-0050					—	0.5	45	4	154
CRN-ES 2002-0060	—	0.6			40	4	174		
CSS 2002-0060	—	0.6			45	4	140		
C-CES 2002-0060	—	0.6			45	4	154		
C-CES 2002-0060S	—	0.6			45	4	168		
DCES 2002-0060	—	0.6			45	4	176		
C-CES 2002-0080	—	0.8			45	4	154		
CSS 2003-0030	—	0.3			45	4	140		
HLS 2003-010	1	0.4			45	4	231		
C-CER 2003-1	1	0.4	45	4	244				
HLS 2003-015	1.5	0.4	45	4	231				
C-CER 2003-1.5	1.5	0.4	45	4	244				
HLS 2003-020	2	0.4	45	4	231				
C-CER 2003-2	2	0.4	45	4	244				
HLS 2003-025	2.5	0.4	45	4	231				
HLS 2003-030	3	0.4	45	4	231				
C-CER 2003-3	3	0.4	45	4	244				
HLS 2003-040	4	0.4	45	4	231				
HLS 2003-060	6	0.4	45	4	231				
HLS 2003-090	9	0.4	45	4	231				
CSS 2003-0045	2 Flutes	0.3	—	0.45	45	4	140		
C-CES 2003-0045			—	0.45	45	4	155		
C-CES 2003-0045S			—	0.45	45	4	168		
CSS 2003-0060-3			—	0.6	38	3	140		
C-CES 2003			—	0.6	38	3	155		
CSS 2003-0060-4			—	0.6	45	4	140		
C-CES 2003-0060			—	0.6	45	4	155		
CSS 2003-0075			—	0.75	45	4	140		
C-CES 2003-0075			—	0.75	45	4	155		
CRN-ES 2003-0090			—	0.9	40	4	174		
CSS 2003-0090	—	0.9	45	4	140				
C-CES 2003-0090	—	0.9	45	4	155				
C-CES 2003-0090S	—	0.9	45	4	168				
CPS 2003	—	0.9	45	4	178				
C-CES 2003-0120	—	1.2	45	4	155				
CSS 2004-0040	2 Flutes	0.4	—	0.4	45	4	141		
CSS 2004-0060			—	0.6	45	4	141		
C-CES 2004-0060			—	0.6	45	4	155		
C-CES 2004-0060S			—	0.6	45	4	168		

Simplified Table

Square

Model Number	Number of Flutes	Outside Diameter	Effective Length	Length of Cut	Overall Length	Shank Diameter	Page	Model Number	Number of Flutes	Outside Diameter	Effective Length	Length of Cut	Overall Length	Shank Diameter	Page
HLS 2004-015	2 Flutes	0.4	1.5	0.6	45	4	231	C-CER 2005-8	2 Flutes	0.5	8	0.7	45	4	245
HLS 2004-020			2	0.6	45	4	231	HLS 2005-100			10	0.7	50	4	231
C-CER 2004-2			2	0.6	45	4	245	HLS 2005-150			15	0.7	50	4	231
HLS 2004-025			2.5	0.6	45	4	231	CSS 2005-0075			—	0.75	45	4	141
HLS 2004-030			3	0.6	45	4	231	C-CES 2005-0075			—	0.75	45	4	155
C-CER 2004-3			3	0.6	45	4	245	C-CES 2005-0075S			—	0.75	45	4	168
HLS 2004-035			3.5	0.6	45	4	231	CAS 2005-0075			—	0.75	45	4	180
HLS 2004-040			4	0.6	45	4	231	CSS 2005-0080			—	0.8	38	3	141
C-CER 2004-4			4	0.6	45	4	245	C-CES 2005			—	0.8	38	3	155
HLS 2004-050			5	0.6	45	4	231	CSS 2005-0100			—	1	45	4	141
C-CER 2004-5			5	0.6	45	4	245	C-CES 2005-0100			—	1	45	4	155
HLS 2004-080			8	0.6	45	4	231	CPR 2005-2			2	1	38	3	258
HLS 2004-120			12	0.6	45	4	231	DCLS 2005-020			2	1	45	4	254
CSS 2004-0080-3			—	0.8	38	3	141	CPR 2005-4			4	1	38	3	258
C-CES 2004			—	0.8	38	3	155	DCLS 2005-040			4	1	45	4	254
CSS 2004-0080-4			—	0.8	45	4	141	CPRL 2005-4			4	1	80	4	262
C-CES 2004-0080			—	0.8	45	4	155	CPR 2005-6			6	1	38	3	258
DCLS 2004-020			2	0.8	45	4	254	DCLS 2005-060			6	1	45	4	254
DCLS 2004-040			4	0.8	45	4	254	CPRL 2005-6			6	1	80	4	262
DCLS 2004-060			6	0.8	45	4	254	CPRL 2005-8			8	1	80	4	262
CSS 2004-0100			—	1	45	4	141	CPRL 2005-10			10	1	80	4	262
C-CES 2004-0100			—	1	45	4	155	CSS 2005-0125			—	1.25	45	4	141
CRN-ES 2004-0120			—	1.2	40	4	174	C-CES 2005-0125			—	1.25	45	4	155
CSS 2004-0120			—	1.2	45	4	141	CRN-ES 2005-0150			—	1.5	40	4	174
C-CES 2004-0120			—	1.2	45	4	155	CSS 2005-0150			—	1.5	45	4	141
C-CES 2004-0120S			—	1.2	45	4	168	C-CES 2005-0150			—	1.5	45	4	155
CPS 2004			—	1.2	45	4	178	C-CES 2005-0150S			—	1.5	45	4	168
C-CES 2004-0160			—	1.6	45	4	155	DCES 2005-0150			—	1.5	45	4	176
CSS 2005-0050	—	0.5	45	4	141	CPS 2005	—	1.5	45	4	178				
HLS 2005-015	1.5	0.7	45	4	231	C-CES 2005-0200	—	2	45	4	155				
HLS 2005-020	2	0.7	45	4	231	CRN-ES 2005-0200	—	2	45	4	174				
C-CER 2005-2	2	0.7	45	4	245	CSS 2006-0060	—	0.6	45	4	141				
HLS 2005-025	2.5	0.7	45	4	231	CSS 2006-0090	—	0.9	45	4	141				
HLS 2005-030	3	0.7	45	4	231	C-CES 2006-0090	—	0.9	45	4	155				
HLS 2005-040	4	0.7	45	4	231	C-CES 2006-0090S	—	0.9	45	4	168				
C-CER 2005-4	4	0.7	45	4	245	HLS 2006-020	2	0.9	45	4	231				
HLS 2005-050	5	0.7	45	4	231	C-CER 2006-2	2	0.9	45	4	245				
HLS 2005-060	6	0.7	45	4	231	HLS 2006-030	3	0.9	45	4	231				
C-CER 2005-6	6	0.7	45	4	245	HLS 2006-040	4	0.9	45	4	231				
HLS 2005-080	1	0.7	45	4	231	C-CER 2006-4	4	0.9	45	4	245				

Simplified Table

Square									
Model Number	Number of Flutes	Outside Diameter	Effective Length	Length of Cut	Overall Length	Shank Diameter	Page		
HLS 2006-050	2 Flutes	0.6	5	0.9	45	4	231		
HLS 2006-060			6	0.9	45	4	231		
C-CER 2006-6			6	0.9	45	4	245		
HLS 2006-070			7	0.9	45	4	231		
HLS 2006-080			8	0.9	45	4	231		
C-CER 2006-8			8	0.9	45	4	245		
HLS 2006-100			10	0.9	45	4	231		
C-CER 2006-10			10	0.9	45	4	245		
HLS 2006-120			12	0.9	50	4	231		
HLS 2006-180			18	0.9	50	4	231		
CSS 2006-0100			—	1	38	3	141		
C-CES 2006			—	1	38	3	155		
CSS 2006-0120			—	1.2	45	4	141		
C-CES 2006-0120			—	1.2	45	4	155		
DCLS 2006-020			2	1.2	45	4	254		
CPR 2006-4			4	1.2	38	3	258		
DCLS 2006-040			4	1.2	45	4	254		
CPR 2006-6			6	1.2	38	3	258		
DCLS 2006-060			6	1.2	45	4	254		
DCLS 2006-080			8	1.2	45	4	254		
DCLS 2006-100			10	1.2	45	4	254		
CSS 2006-0150			—	1.5	45	4	141		
C-CES 2006-0150			—	1.5	45	4	155		
CRN-ES 2006-0180			—	1.8	40	4	174		
CSS 2006-0180			—	1.8	45	4	141		
C-CES 2006-0180			—	1.8	45	4	155		
CPS 2006			—	1.8	45	4	178		
C-CES 2006-0240			—	2.4	45	4	155		
CRN-ES 2006-0240	—	2.4	45	4	174				
CSS 2007-0070	2 Flutes	0.7	—	0.7	45	4	141		
CSS 2007-0100			—	1	38	3	141		
C-CES 2007			—	1	38	3	155		
HLS 2007-020			2	1	45	4	232		
C-CER 2007-2			2	1	45	4	245		
C-CER 2007-3			3	1	45	4	245		
HLS 2007-040			4	1	45	4	232		
C-CER 2007-4			4	1	45	4	245		
HLS 2007-060			6	1	45	4	232		
C-CER 2007-6			6	1	45	4	245		
HLS 2007-080			8	1	45	4	232		
C-CER 2007-8			2 Flutes	0.7	8	1	45	4	245
HLS 2007-100					10	1	50	4	232
HLS 2007-100					10	1	50	4	232
C-CER 2007-10					10	1	50	4	245
C-CES 2007-0105S					—	1.05	45	4	168
CSS 2007-0140					—	1.4	45	4	141
C-CES 2007-0140					—	1.4	45	4	155
CPR 2007-4					4	1.4	38	3	258
DCLS 2007-040					4	1.4	45	4	255
CPR 2007-6	6	1.4			38	3	258		
DCLS 2007-060	6	1.4			45	4	255		
DCLS 2007-080	8	1.4			45	4	255		
DCLS 2007-100	10	1.4	45	4	255				
CSS 2007-0175	—	1.75	45	4	141				
C-CES 2007-0175	—	1.75	45	4	155				
CSS 2007-0210	—	2.1	45	4	141				
C-CES 2007-0210	—	2.1	45	4	155				
CPS 2007	—	2.1	45	4	178				
C-CES 2007-0280	—	2.8	45	4	155				
CSS 2008-0080	2 Flutes	0.8	—	0.8	45	4	141		
CSS 2008-0120-3			—	1.2	38	3	141		
C-CES 2008			—	1.2	38	3	155		
CSS 2008-0120-4			—	1.2	45	4	141		
C-CES 2008-0120			—	1.2	45	4	155		
C-CES 2008-0120S			—	1.2	45	4	168		
HLS 2008-030			3	1.2	45	4	232		
HLS 2008-040			4	1.2	45	4	232		
C-CER 2008-4			4	1.2	45	4	245		
HLS 2008-050			5	1.2	45	4	232		
HLS 2008-060			6	1.2	45	4	232		
C-CER 2008-6			6	1.2	45	4	245		
HLS 2008-080			8	1.2	45	4	232		
C-CER 2008-8			8	1.2	45	4	245		
HLS 2008-100			10	1.2	50	4	232		
C-CER 2008-10			10	1.2	50	4	245		
HLS 2008-120			12	1.2	50	4	232		
C-CER 2008-12			12	1.2	50	4	245		
HLS 2008-160			16	1.2	50	4	232		
HLS 2008-240			24	1.2	60	4	232		
CSS 2008-0160	—	1.6	45	4	141				
C-CES 2008-0160	—	1.6	45	4	155				

Simplified Table

Square

Model Number	Number of Flutes	Outside Diameter	Effective Length	Length of Cut	Overall Length	Shank Diameter	Page	Model Number	Number of Flutes	Outside Diameter	Effective Length	Length of Cut	Overall Length	Shank Diameter	Page		
DCLS 2008-040	2 Flutes	0.8	4	1.6	45	4	255	HLS 4010-060	4 Flutes		6	1	50	4	276		
DCLS 2008-060			6	1.6	45	4	255	HLS 4010-080			8	1	50	4	276		
CPR 2008-6			6	1.6	45	4	258	HLS 4010-100			10	1	50	4	276		
DCLS 2008-080			8	1.6	45	4	255	HLS 4010-120			12	1	50	4	276		
CPR 2008-8			8	1.6	45	4	258	HLS 4010-160			16	1	60	4	276		
DCLS 2008-100			10	1.6	45	4	255	CSS 2010-0150			—	1.5	45	4	141		
CSS 2008-0200			—	2	45	4	141	C-CES 2010-0150			—	1.5	45	4	156		
C-CES 2008-0200			—	2	45	4	155	C-CES 2010-0150S			—	1.5	45	4	168		
CRN-ES 2008-0240			—	2.4	40	4	174	CAS 2010-0150			—	1.5	45	4	180		
CSS 2008-0240			—	2.4	45	4	141	HLS 2010-030			3	1.5	45	4	232		
C-CES 2008-0240			—	2.4	45	4	155	HLS 2010-040	4	1.5	45	4	232				
C-CES 2008-0240S			—	2.4	45	4	168	C-CER 2010-4	4	1.5	45	4	245				
CPS 2008			—	2.4	45	4	178	HLS 2010-050	5	1.5	45	4	232				
C-CES 2008-0320			—	3.2	45	4	155	HLS 2010-060	6	1.5	45	4	232				
CSS 2009-0090			2 Flutes	0.9	—	0.9	45	4	141	C-CER 2010-6	2 Flutes	1	6	1.5	45	4	245
CSS 2009-0120					—	1.2	38	3	141	HLS 2010-070			7	1.5	45	4	232
C-CES 2009					—	1.2	38	3	155	HLS 2010-080			8	1.5	45	4	232
HLS 2009-040	4	1.3			45	4	232	C-CER 2010-8	8	1.5			45	4	245		
C-CER 2009-4	4	1.3			45	4	245	HLS 2010-090	9	1.5			45	4	232		
HLS 2009-060	6	1.3			45	4	232	HLS 2010-100	10	1.5			45	4	232		
C-CER 2009-6	6	1.3			45	4	245	C-CER 2010-10	10	1.5			45	4	245		
HLS 2009-080	8	1.3			45	4	232	HLS 2010-120	12	1.5			45	4	232		
C-CER 2009-8	8	1.3			45	4	245	C-CER 2010-12	12	1.5			45	4	245		
HLS 2009-100	10	1.3			45	4	232	HLS 2010-140	14	1.5			45	4	232		
C-CER 2009-10	10	1.3			45	4	245	HLS 2010-160	16	1.5	50	4	232				
HLS 2009-150	15	1.3			50	4	232	C-CER 2010-16	16	1.5	50	4	245				
C-CER 2009-15	15	1.3			50	4	245	HLS 2010-180	18	1.5	55	4	232				
C-CES 2009-0135S	—	1.35			45	4	168	HLS 2010-200	20	1.5	55	4	232				
CSS 2009-0180	—	1.8			45	4	141	C-CER 2010-20	20	1.5	55	4	245				
C-CES 2009-0180	—	1.8			45	4	155	HLS 2010-250	25	1.5	70	4	232				
CPR 2009-6	6	1.8			45	4	258	HLS 2010-300	30	1.5	70	4	232				
CPR 2009-10	10	1.8			45	4	258	CZS 4010-0150	—	1.5	50	4	182				
CSS 2009-0225	—	2.25			45	4	141	CXS 4010-030	3	1.5	50	4	282				
C-CES 2009-0225	—	2.25			45	4	155	CXS 4010-050	5	1.5	70	4	282				
CSS 2009-0270	—	2.7			45	4	141	CXS 4010-060	6	1.5	70	4	282				
C-CES 2009-0270	—	2.7			45	4	155	CSS 2010-0200	—	2	45	4	141				
CPS 2009	—	2.7			45	4	178	C-CES 2010-0200	—	2	45	4	156				
C-CES 2009-0360	—	3.6			45	4	155	DCLS 2010-040	4	2	45	4	255				
CSS 2010-0100	2 Flutes	1			—	1	45	4	141	DCLS 2010-060	2 Flutes		6	2	45	4	255
HLS 4010-040	4 Flutes				4	1	50	4	276	CPR 2010-6			6	2	45	4	258

Simplified Table

Square									
Model Number	Number of Flutes	Outside Diameter	Effective Length	Length of Cut	Overall Length	Shank Diameter	Page		
CPRL	2010-6	2 Flutes	1	6	2	80	4 262		
DCLS	2010-080			8	2	45	4 255		
CPR	2010-8			8	2	45	4 258		
CPRL	2010-8			8	2	80	4 262		
DCLS	2010-100			10	2	45	4 255		
CPR	2010-10			10	2	45	4 258		
CPRL	2010-10			10	2	80	4 262		
CPR	2010-12			12	2	45	4 258		
CPRL	2010-12			12	2	80	4 262		
CPRL	2010-14			14	2	80	4 262		
DCLS	2010-160			16	2	50	4 255		
CPR	2010-16			16	2	50	4 258		
CPRL	2010-16			16	2	80	4 262		
CPRL	2010-18			18	2	80	4 262		
DCLS	2010-210			21	2	55	4 255		
CPR	2010-21			21	2	55	4 258		
CPRL	2010-21			21	2	80	4 262		
AZS	3010-030			3 Flutes	1	3	2	60	4 267
DLC-AZS	3010-030					3	2	60	4 270
AZS	3010-050					5	2	60	4 267
DLC-AZS	3010-050	5	2	60	4 270				
CSS	2010-0250	2 Flutes	1	—	2.5	45	4 141		
C-CES	2010			—	2.5	45	4 156		
HMS	3010-0250	3 Flutes	1	—	2.5	45	4 226		
C-CES	4010			—	2.5	45	4 208		
C-CES	4010S	4 Flutes	1	—	2.5	45	4 214		
CZS	4010-0250			—	2.5	50	4 182		
CXES	4010-0250			—	2.5	50	4 196		
CSS	2010-0300			—	3	45	4 141		
C-CES	2010-0300	2 Flutes	1	—	3	45	4 156		
C-CES	2010-0300S			—	3	45	4 168		
CRN-ES	2010-0300			—	3	45	4 174		
DCES	2010-0300			—	3	45	4 176		
CPS	2010	4 Flutes	1	—	3	50	4 178		
C-CES	4010-0300			—	3	45	4 208		
CXES	4010-0300	3 Flutes	1	—	3	60	4 196		
HMS	3010-0350			—	3.5	45	4 226		
C-CES	2010-0400	2 Flutes	1	—	4	45	4 156		
CRN-ES	2010-0400			—	4	50	4 174		
C-CES	4010-0400	4 Flutes	1	—	4	45	4 208		
CXES	4010-0400			—	4	50	4 208		
CXES	4010-0400	4 Flutes	1	—	4	45	4 208		
DCLS	2010-080			8	2	45	4 258		
CPR	2010-8	2 Flutes	1.1	—	2.5	45	4 156		
CPRL	2010-8			—	2.5	50	4 182		
DCLS	2010-100	4 Flutes	1	6	1.2	50	4 276		
CPR	2010-10			8	1.2	50	4 276		
CPRL	2010-10			10	1.2	50	4 276		
CPR	2010-12			12	1.2	50	4 276		
CPRL	2010-12	4 Flutes	1	16	1.2	60	4 276		
CPRL	2010-14			—	1.8	45	4 156		
DCLS	2010-160	2 Flutes	1.2	—	1.8	45	4 168		
CPR	2010-16			4	1.8	45	4 233		
CPRL	2010-16	4 Flutes	1	6	1.8	45	4 233		
CPRL	2010-18			8	1.8	45	4 233		
DCLS	2010-210	2 Flutes	1.2	8	1.8	45	4 245		
CPR	2010-21			8	1.8	45	4 245		
CPRL	2010-21	4 Flutes	1	10	1.8	45	4 233		
AZS	3010-030			10	1.8	45	4 245		
DLC-AZS	3010-030	3 Flutes	1	12	1.8	45	4 233		
AZS	3010-050			12	1.8	45	4 245		
DLC-AZS	3010-050	2 Flutes	1.2	16	1.8	50	4 233		
CSS	2010-0250			16	1.8	50	4 245		
C-CES	2010	3 Flutes	1	20	1.8	60	4 233		
HMS	3010-0250			—	2.4	45	4 156		
C-CES	4010	4 Flutes	1	6	2.4	45	4 258		
C-CES	4010S			8	2.4	45	4 258		
CZS	4010-0250			10	2.4	45	4 258		
CXES	4010-0250			12	2.4	50	4 258		
CSS	2010-0300	2 Flutes	1	—	2.5	50	4 182		
C-CES	2010-0300			—	3	45	4 156		
C-CES	2010-0300S	2 Flutes	1	—	3.6	45	4 156		
CRN-ES	2010-0300			—	3.6	45	4 168		
DCES	2010-0300			—	3.6	50	4 178		
CPS	2010			—	4	45	4 156		
C-CES	4010-0300	4 Flutes	1.3	—	4.8	45	4 156		
CXES	4010-0300			—	3	50	4 182		
HMS	3010-0350	2 Flutes	1.4	—	4	45	4 156		
C-CES	2010-0400			6	1.4	50	4 277		
CRN-ES	2010-0400	4 Flutes	1	8	1.4	50	4 277		
C-CES	4010-0400			10	1.4	50	4 277		

Simplified Table

Square

Model Number	Number of Flutes	Outside Diameter	Effective Length	Length of Cut	Overall Length	Shank Diameter	Page	Model Number	Number of Flutes	Outside Diameter	Effective Length	Length of Cut	Overall Length	Shank Diameter	Page				
HLS 4014-120	4 Flutes	1.4	12	1.4	50	4	277	HLS 2015-040	2 Flutes	1.5	4	2.3	45	4	233				
HLS 4014-140			14	1.4	60	4	277	HLS 2015-060			6	2.3	45	4	233				
HLS 4014-160			16	1.4	60	4	277	C-CER 2015-6			6	2.3	45	4	246				
HLS 4014-220			22	1.4	60	4	277	HLS 2015-080			8	2.3	45	4	233				
HLS 2014-060	2 Flutes	1.4	6	2.1	45	4	233	C-CER 2015-8			8	2.3	45	4	246				
C-CER 2014-6			6	2.1	45	4	245	HLS 2015-100			10	2.3	45	4	233				
HLS 2014-080			8	2.1	45	4	233	C-CER 2015-10			10	2.3	45	4	246				
C-CER 2014-8			8	2.1	45	4	245	HLS 2015-120			12	2.3	45	4	233				
HLS 2014-100			10	2.1	45	4	233	C-CER 2015-12			12	2.3	45	4	246				
C-CER 2014-10			10	2.1	45	4	245	HLS 2015-140			14	2.3	50	4	233				
HLS 2014-120			12	2.1	45	4	233	C-CER 2015-14			14	2.3	50	4	246				
C-CER 2014-12			12	2.1	45	4	245	HLS 2015-160			16	2.3	50	4	233				
HLS 2014-140			14	2.1	45	4	233	C-CER 2015-16			16	2.3	50	4	246				
C-CER 2014-14			14	2.1	45	4	245	HLS 2015-180			18	2.3	55	4	233				
HLS 2014-160			16	2.1	50	4	233	C-CER 2015-18			18	2.3	55	4	246				
C-CER 2014-16			16	2.1	50	4	245	HLS 2015-200			20	2.3	55	4	233				
HLS 2014-220			22	2.1	55	4	233	C-CER 2015-20			20	2.3	55	4	246				
C-CER 2014-22			22	2.1	55	4	245	HLS 2015-250			25	2.3	70	4	233				
CPR 2014-6			4 Flutes	1.4	6	2.8	45	4			259	HLS 2015-300	2 Flutes	1.5	30	2.3	70	4	233
CPR 2014-10					10	2.8	45	4			259	HLS 2015-350			35	2.3	70	4	233
CPR 2014-16	16	2.8			50	4	259	HLS 2015-400	40	2.3	80	4			233				
CZS 4014-0300	2 Flutes	—	3	50	4	182	HLS 2015-450	45	2.3	80	4	233							
C-CES 2014	2 Flutes	—	4	45	4	156	CSS 2015-0300	—	3	45	4	141							
CSS 2015-0150	2 Flutes	—	1.5	45	4	141	C-CES 2015-0300	—	3	45	4	156							
HLS 4015-060	4 Flutes	1.5	6	1.5	50	4	277	DCLS 2015-060	6	3	45	4			255				
HLS 4015-080			8	1.5	50	4	277	CPR 2015-6	6	3	45	4			259				
HLS 4015-100			10	1.5	50	4	277	CPRL 2015-6	6	3	80	4			262				
HLS 4015-120			12	1.5	50	4	277	CPRL 2015-8	8	3	80	4			262				
HLS 4015-140			14	1.5	60	4	277	DCLS 2015-100	10	3	45	4			255				
HLS 4015-160			16	1.5	60	4	277	CPR 2015-10	10	3	45	4			259				
HLS 4015-180			18	1.5	60	4	277	CPRL 2015-10	10	3	80	4			262				
HLS 4015-200			20	1.5	60	4	277	CPRL 2015-14	14	3	50	4			259				
CSS 2015-0225	2 Flutes	1.5	—	2.25	45	4	141	CPRL 2015-14	14	3	80	4			262				
C-CES 2015-0225			—	2.25	45	4	156	DCLS 2015-160	16	3	50	4			255				
C-CES 2015-0225S			—	2.25	45	4	169	CPR 2015-16	16	3	50	4			259				
CAS 2015-0225			—	2.25	45	4	180	CPRL 2015-16	16	3	80	4			262				
CZS 4015-0225	4 Flutes	1.5	—	2.25	50	4	182	DCLS 2015-210	21	3	55	4			255				
CXS 4015-045			4.5	2.25	50	4	282	CPRL 2015-21	21	3	55	4			259				
CXS 4015-070			7	2.25	70	4	282	CPRL 2015-21	21	3	80	4	262						
CXS 4015-085			8.5	2.25	70	4	282	AZS 3015-045	3 Flutes	4.5	3	60	4	267					

Simplified Table

Square								
Model Number	Number of Flutes	Outside Diameter	Effective Length	Length of Cut	Overall Length	Shank Diameter	Page	
DLC-AZS 3015-045	3 Flutes	1.5	4.5	3	60	4	270	
CSS 2015-0375	2 Flutes		—	3.75	45	4	141	
C-CES 2015-0375			—	3.75	45	4	156	
C-CES 4015	4 Flutes		—	3.75	45	4	208	
C-CES 4015S			—	3.75	45	4	214	
CXES 4015-0375			—	3.75	50	4	196	
C-CES 2015	2 Flutes		—	4	45	4	156	
HMS 3015-0400	3 Flutes		—	4	45	4	226	
CZS 4015-0400	4 Flutes		—	4	50	4	182	
CSS 2015-0450	2 Flutes		—	4.5	45	4	141	
C-CES 2015-0450			—	4.5	45	4	156	
C-CES 2015-0450S			—	4.5	45	4	169	
CRN-ES 2015-0450			—	4.5	45	4	174	
DCES 2015-0450			—	4.5	45	4	176	
CPS 2015			—	4.5	50	4	178	
C-CES 4015-0450			4 Flutes	—	4.5	45	4	208
C-CES 2015-0600			2 Flutes	—	6	45	4	156
CRN-ES 2015-0600				—	6	50	4	174
HMS 3015-0600			3 Flutes	—	6	45	4	226
C-CES 4015-0600	4 Flutes		—	6	45	4	208	
CXES 4015-0600			—	6	50	4	196	
HLS 4016-060			6	1.6	50	4	277	
HLS 4016-080	4 Flutes		8	1.6	50	4	277	
HLS 4016-100			10	1.6	50	4	277	
HLS 4016-120			12	1.6	50	4	277	
HLS 4016-140			14	1.6	60	4	277	
HLS 4016-160			16	1.6	60	4	277	
HLS 4016-180			18	1.6	60	4	277	
HLS 4016-200		20	1.6	60	4	277		
HLS 4016-260		26	1.6	60	4	277		
HLS 2016-060		2 Flutes	6	2.4	45	4	233	
C-CER 2016-6			6	2.4	45	4	246	
HLS 2016-080	8		2.4	45	4	233		
C-CER 2016-8	8		2.4	45	4	246		
HLS 2016-100	10		2.4	45	4	233		
C-CER 2016-10	10		2.4	45	4	246		
HLS 2016-120	12		2.4	45	4	233		
C-CER 2016-12	12		2.4	45	4	246		
HLS 2016-140	14		2.4	50	4	233		
C-CER 2016-14	14		2.4	50	4	246		

Model Number	Number of Flutes	Outside Diameter	Effective Length	Length of Cut	Overall Length	Shank Diameter	Page
HLS 2016-160	2 Flutes	1.6	16	2.4	50	4	233
C-CER 2016-16			16	2.4	50	4	246
HLS 2016-180			18	2.4	55	4	233
C-CER 2016-18			18	2.4	55	4	246
HLS 2016-200			20	2.4	55	4	233
C-CER 2016-20			20	2.4	55	4	246
HLS 2016-260			26	2.4	60	4	233
C-CER 2016-26			26	2.4	60	4	246
CPR 2016-6			6	3.2	50	4	259
CZS 4016-0400			4 Flutes	—	4	50	4
C-CES 2016	2 Flutes	—	5	45	4	156	
CZS 4017-0400	4 Flutes	1.7	—	4	50	4	182
C-CES 2017	2 Flutes		—	5	45	4	156
HLS 4018-060	4 Flutes		6	1.8	50	4	277
HLS 4018-080			8	1.8	50	4	277
HLS 4018-100			10	1.8	50	4	277
HLS 4018-120			12	1.8	50	4	277
HLS 4018-140			14	1.8	60	4	277
HLS 4018-160			16	1.8	60	4	277
HLS 4018-180			18	1.8	60	4	277
HLS 4018-200			20	1.8	60	4	277
HLS 4018-250		25	1.8	70	4	277	
C-CES 2018-0270		—	2.7	45	4	156	
C-CES 2018-0270S	—	2.7	45	4	169		
HLS 2018-060	2 Flutes	1.8	6	2.7	45	4	234
C-CER 2018-6			6	2.7	45	4	246
HLS 2018-080			8	2.7	45	4	234
C-CER 2018-8			8	2.7	45	4	246
HLS 2018-100			10	2.7	45	4	234
C-CER 2018-10			10	2.7	45	4	246
HLS 2018-120			12	2.7	45	4	234
C-CER 2018-12			12	2.7	45	4	246
HLS 2018-140			14	2.7	50	4	234
C-CER 2018-14			14	2.7	50	4	246
HLS 2018-160			16	2.7	50	4	234
C-CER 2018-16			16	2.7	50	4	246
HLS 2018-180			18	2.7	55	4	234
C-CER 2018-18			18	2.7	55	4	246
HLS 2018-200			20	2.7	55	4	234
C-CER 2018-20			20	2.7	55	4	246

Simplified Table

Square

Model Number	Number of Flutes	Outside Diameter	Effective Length	Length of Cut	Overall Length	Shank Diameter	Page
HLS 2018-250	2 Flutes	1.8	25	2.7	60	4	234
C-CER 2018-25			25	2.7	60	4	246
C-CES 2018-0360	4 Flutes		—	3.6	45	4	156
CZS 4018-0400			—	4	50	4	182
C-CES 2018-0450	2 Flutes		—	4.5	45	4	156
C-CES 2018			—	5	45	4	156
C-CES 2018-0540			—	5.4	45	4	156
C-CES 2018-0540S			—	5.4	45	4	169
C-CES 2018-0720			—	7.2	45	4	156
CZS 4018-0400			4 Flutes	1.9	—	4	50
C-CES 2019	2 Flutes	—	5		45	4	156
CSS 2020-0200	2 Flutes	—	2		45	4	141
HLS 4020-060	4 Flutes	6	2		50	4	277
HLS 4020-080		8	2		50	4	277
HLS 4020-100		10	2		50	4	277
HLS 4020-120		12	2		50	4	277
HLS 4020-140		14	2		60	4	277
HLS 4020-160		16	2		60	4	277
HLS 4020-180		18	2		60	4	277
HLS 4020-200		20	2	60	4	277	
HLS 4020-250		25	2	70	4	277	
HLS 4020-300		30	2	70	4	277	
CSS 2020-0300	2 Flutes	2	—	3	45	4	141
C-CES 2020-0300			—	3	45	4	156
C-CES 2020-0300S			—	3	45	4	169
CAS 2020-0300			—	3	45	4	180
HLS 2020-060			6	3	45	4	234
C-CER 2020-6			6	3	45	4	246
HLS 2020-080			8	3	45	4	234
C-CER 2020-8			8	3	45	4	246
HLS 2020-100			10	3	45	4	234
C-CER 2020-10			10	3	45	4	246
HLS 2020-120	12	3	45	4	234		
C-CER 2020-12	12	3	45	4	246		
HLS 2020-140	14	3	50	4	234		
C-CER 2020-14	14	3	50	4	246		
HLS 2020-160	16	3	50	4	234		
C-CER 2020-16	16	3	50	4	246		
HLS 2020-180	18	3	55	4	234		
C-CER 2020-18	18	3	55	4	246		

Model Number	Number of Flutes	Outside Diameter	Effective Length	Length of Cut	Overall Length	Shank Diameter	Page
HLS 2020-200	2 Flutes	2	20	3	55	4	234
C-CER 2020-20			20	3	55	4	246
HLS 2020-250			25	3	60	4	234
C-CER 2020-25			25	3	60	4	246
HLS 2020-300			30	3	70	4	234
C-CER 2020-30			30	3	70	4	246
HLS 2020-350			35	3	80	4	234
HLS 2020-400			40	3	90	4	234
HLS 2020-500			50	3	100	4	234
HLS 2020-600			60	3	110	4	234
CZS 4020-0300	4 Flutes	—	3	50	4	183	
CXS 4020-060		6	3	50	4	282	
CXS 4020-090		9	3	70	4	282	
CXS 4020-110	11	3	70	4	282		
CSS 2020-0400	2 Flutes	2	—	4	45	4	141
C-CES 2020-0400			—	4	45	4	156
DCLS 2020-060			6	4	50	4	255
CPR 2020-8			8	4	50	4	259
CPRL 2020-8			8	4	80	4	263
DCLS 2020-100			10	4	50	4	255
CPR 2020-10			10	4	50	4	259
CPRL 2020-10			10	4	80	4	263
CPR 2020-12			12	4	50	4	259
CPRL 2020-12			12	4	80	4	263
CPR 2020-14	14	4	50	4	259		
CPRL 2020-14	14	4	80	4	263		
DCLS 2020-160	16	4	50	4	255		
CPR 2020-16	16	4	50	4	259		
CPRL 2020-16	16	4	80	4	263		
CPR 2020-18	18	4	55	4	259		
CPRL 2020-18	18	4	80	4	263		
DCLS 2020-210	21	4	55	4	255		
CPR 2020-21	21	4	55	4	259		
CPRL 2020-21	21	4	80	4	263		
DCLS 2020-260	26	4	55	4	255		
CPR 2020-26	26	4	55	4	259		
CPRL 2020-26	26	4	80	4	263		
CPR 2020-32	32	4	70	4	259		
CPRL 2020-32	32	4	80	4	263		
CPRL 2020-40	40	4	100	4	263		

Simplified Table

Square							
Model Number	Number of Flutes	Outside Diameter	Effective Length	Length of Cut	Overall Length	Shank Diameter	Page
HMS 3020-0400	3 Flutes	2	—	4	45	4	226
AZS 3020-060			6	4	60	4	267
DLC-AZS 3020-060			6	4	60	4	270
AZS 3020-100			10	4	60	4	267
DLC-AZS 3020-100			10	4	60	4	270
CSS 2020-0500	2 Flutes	2	—	5	45	4	141
C-CES 2020-0500			—	5	45	4	156
C-CES 4020	4 Flutes	2	—	5	45	4	208
CXES 4020-0500			—	5	50	4	196
CSS 2020-0600			—	6	45	4	141
C-CES 2020	2 Flutes	2	—	6	45	4	156
C-CES 2020-0600S			—	6	45	4	169
CRN-ES 2020-0600			—	6	45	4	174
DCES 2020-0600			—	6	45	4	176
CPS 2020			—	6	55	4	178
C-CES 4020-0600	4 Flutes	2	—	6	45	4	208
C-CES 4020S			—	6	45	4	214
CZS 4020-0600			—	6	50	4	183
CXES 4020-0600			—	6	60	4	196
HMS 3020-0700	3 Flutes	2	—	7	45	4	226
C-CES 2020-0800			—	8	45	4	156
CRN-ES 2020-0800	2 Flutes	2	—	8	50	4	174
C-CES 4020-0800			—	8	45	4	208
CXES 4020-0800			—	8	60	4	196
CXES 4020-1000			—	10	60	4	196
CGE 4020	2 Flutes	2.1	—	15	60	3	224
C-CES 2021			—	6	45	4	156
CZS 4021-0600			—	6	50	4	183
C-CES 2022	2 Flutes	2.2	—	6	45	4	156
CZS 4022-0600			—	6	50	4	183
C-CES 2023	2 Flutes	2.3	—	6	45	4	156
CZS 4023-0600			—	6	50	4	183
CZS 4024-0600	4 Flutes	2.4	—	6	50	4	183
C-CES 2024			—	8	45	4	156
CSS 2025-0250	2 Flutes	2.5	—	2.5	50	4	142
HLS 4025-080			8	2.5	50	4	278
HLS 4025-120	4 Flutes	2.5	12	2.5	50	4	278
HLS 4025-160			16	2.5	60	4	278
HLS 4025-200			20	2.5	60	4	278
HLS 4025-250			25	2.5	70	4	278
HLS 4025-300	4 Flutes	2.5	30	3.7	70	4	234
HLS 2025-080			8	3.7	45	4	234
C-CER 2025-8	2 Flutes	2.5	8	3.7	45	4	246
HLS 2025-100			10	3.7	45	4	234
C-CER 2025-10	2 Flutes	2.5	10	3.7	45	4	246
HLS 2025-120			12	3.7	45	4	234
C-CER 2025-12	2 Flutes	2.5	12	3.7	45	4	246
HLS 2025-140			14	3.7	50	4	234
C-CER 2025-14	2 Flutes	2.5	14	3.7	50	4	246
HLS 2025-160			16	3.7	50	4	234
C-CER 2025-16	2 Flutes	2.5	16	3.7	50	4	246
HLS 2025-180			18	3.7	55	4	234
C-CER 2025-18	2 Flutes	2.5	18	3.7	55	4	246
HLS 2025-200			20	3.7	55	4	234
C-CER 2025-20	2 Flutes	2.5	20	3.7	55	4	246
HLS 2025-250			25	3.7	60	4	234
C-CER 2025-25	2 Flutes	2.5	25	3.7	60	4	246
HLS 2025-300			30	3.7	70	4	234
C-CER 2025-30	2 Flutes	2.5	30	3.7	70	4	246
HLS 2025-400			40	3.7	90	4	234
HLS 2025-500	2 Flutes	2.5	50	3.7	100	4	234
C-CES 2025-0375			—	3.75	45	4	157
C-CES 2025-0375S	2 Flutes	2.5	—	3.75	45	4	169
CSS 2025-0375			—	3.75	50	4	142
CAS 2025-0375	2 Flutes	2.5	—	3.75	50	6	180
CZS 4025-0375			—	3.75	50	4	183
CXS 4025-075	4 Flutes	2.5	7.5	3.75	50	4	282
CXS 4025-110			11	3.75	70	4	282
CXS 4025-135			13.5	3.75	70	4	282
C-CES 2025-0500	2 Flutes	2.5	—	5	45	4	157
CSS 2025-0500			—	5	50	4	142
CPR 2025-12	2 Flutes	2.5	12	5	55	4	259
CPR 2025-21			21	5	55	4	259
AZS 3025-075	3 Flutes	2.5	7.5	5	60	4	267
DLC-AZS 3025-075			7.5	5	60	4	270
C-CES 2025-0625	2 Flutes	2.5	—	6.25	45	4	157
CSS 2025-0625			—	6.25	50	4	142
C-CES 4025	4 Flutes	2.5	—	6.25	45	4	208
C-CES 4025S			—	6.25	45	4	214
CXES 4025-0625			—	6.25	50	4	196

Simplified Table

Square

Model Number	Number of Flutes	Outside Diameter	Effective Length	Length of Cut	Overall Length	Shank Diameter	Page		
C-CES 2025-0750	2 Flutes	2.5	—	7.5	45	4	157		
CRN-ES 2025-0750			—	7.5	45	4	174		
CSS 2025-0750			—	7.5	50	4	142		
CPS 2025			—	7.5	55	4	178		
C-CES 4025-0750			4 Flutes	—	7.5	50	4	208	
C-CES 2025			2 Flutes	—	8	45	4	157	
CZS 4025-0800			4 Flutes	—	8	50	4	183	
C-CES 2025-1000			2 Flutes	—	10	50	4	157	
CXES 4025-1000			4 Flutes	—	10	50	4	196	
C-CES 4025-1000			4 Flutes	—	10	50	4	208	
C-CES 2026			2 Flutes	2.6	—	8	45	6	157
CZS 4026-0800			4 Flutes		—	8	50	4	183
C-CES 2027	2 Flutes	2.7	—	8	45	6	157		
CZS 4027-0800	4 Flutes		—	8	50	4	183		
C-CES 2028	2 Flutes	2.8	—	8	45	6	157		
CZS 4028-0800	4 Flutes		—	8	50	4	183		
C-CES 2029	2 Flutes	2.9	—	8	45	6	157		
CZS 4029-0800	4 Flutes		—	8	50	4	183		
CSS 2030-0300	2 Flutes	3	—	3	50	6	142		
HLS 4030-080	4 Flutes		8	3	50	6	278		
HLS 4030-120			12	3	50	6	278		
HLS 4030-160			16	3	60	6	278		
HLS 4030-200			20	3	60	6	278		
HLS 4030-250			25	3	70	6	278		
HLS 4030-300			30	3	70	6	278		
HLS 4030-400			40	3	80	6	278		
C-CES 2030-0450			—	4.5	45	6	157		
C-CES 2030-0450S			—	4.5	45	6	169		
CSS 2030-0450			—	4.5	50	6	142		
CAS 2030-0450			—	4.5	50	6	180		
CPS 2030SS		—	4.5	60	3	178			
HLS 2030-080	2 Flutes	8	4.5	45	6	235			
C-CER 2030-8		8	4.5	45	6	247			
HLS 2030-100		10	4.5	45	6	235			
C-CER 2030-10		10	4.5	45	6	247			
HLS 2030-120		12	4.5	50	6	235			
C-CER 2030-12		12	4.5	50	6	247			
HLS 2030-140		14	4.5	50	6	235			
C-CER 2030-14		14	4.5	50	6	247			
HLS 2030-160		16	4.5	60	6	235			

Model Number	Number of Flutes	Outside Diameter	Effective Length	Length of Cut	Overall Length	Shank Diameter	Page
C-CER 2030-16	2 Flutes	3	16	4.5	60	6	247
HLS 2030-180			18	4.5	60	6	235
C-CER 2030-18			18	4.5	60	6	247
HLS 2030-200			20	4.5	60	6	235
C-CER 2030-20			20	4.5	60	6	247
HLS 2030-250			25	4.5	70	6	235
C-CER 2030-25			25	4.5	70	6	247
HLS 2030-300			30	4.5	80	6	235
C-CER 2030-30			30	4.5	80	6	247
HLS 2030-350			35	4.5	80	6	235
C-CER 2030-35			35	4.5	80	6	247
HLS 2030-400			40	4.5	90	6	235
C-CER 2030-40	40	4.5	90	6	247		
HLS 2030-500	50	4.5	100	6	235		
CZS 4030-0450	4 Flutes	—	4.5	60	6	183	
CXS 4030-090		9	4.5	50	6	283	
CXS 4030-130		13	4.5	70	6	283	
CXS 4030-160		16	4.5	70	6	283	
C-CES 2030-0600		—	6	45	6	157	
CSS 2030-0600		—	6	50	6	142	
CPS 2030SSL	—	6	100	3	178		
CPR 2030-8	2 Flutes	8	6	70	6	259	
CPR 2030-12		12	6	70	6	259	
CPRL 2030-12		12	6	100	6	263	
DCLS 2030-160		16	6	70	6	255	
CPR 2030-16		16	6	70	6	259	
CPRL 2030-16		16	6	100	6	263	
DCLS 2030-210		21	6	70	6	255	
CPR 2030-21		21	6	70	6	259	
CPRL 2030-21		21	6	100	6	263	
DCLS 2030-260		26	6	70	6	255	
CPR 2030-26		26	6	70	6	259	
CPRL 2030-26		26	6	100	6	263	
DCLS 2030-320	32	6	80	6	255		
CPR 2030-32	32	6	80	6	259		
CPRL 2030-32	32	6	100	6	263		
CPR 2030-42	42	6	90	6	259		
HMS 3030-0600	3 Flutes	—	6	50	6	226	
AZS 3030-090		9	6	70	6	267	
DLC-AZS 3030-090		9	6	70	6	270	

Simplified Table

Square							
Model Number	Number of Flutes	Outside Diameter	Effective Length	Length of Cut	Overall Length	Shank Diameter	Page
AZS 3030-150	3 Flutes		15	6	70	6	267
DLC-AZS 3030-150			15	6	70	6	270
C-CES 2030-0750	2 Flutes		—	7.5	45	6	157
CSS 2030-0750			—	7.5	50	6	142
C-CES 4030-0750	4 Flutes		—	7.5	45	6	208
CXES 4030-0750			—	7.5	50	6	197
C-CES 2030	2 Flutes		—	8	45	6	157
C-CES 4030	4 Flutes		—	8	45	6	208
C-CES 4030S			—	8	45	6	214
CZS 4030-0800	4 Flutes		—	8	60	6	183
C-CES 2030-0900			—	9	45	6	157
C-CES 2030-0900S	2 Flutes		—	9	45	6	169
DCES 2030-0900			—	9	45	6	176
CSS 2030-0900	2 Flutes		—	9	50	6	142
CRN-ES 2030-0900			—	9	50	6	174
CAS 2030-0900	4 Flutes		—	9	50	6	180
CPS 2030			—	9	60	6	178
C-CES 4030-0900	4 Flutes		—	9	50	6	208
DCES 4030-0900			—	9	50	6	222
CRN-ES 4030-0900	4 Flutes		—	9	50	6	220
CXES 4030-0900			—	9	60	6	197
HMS 3030-1000	3 Flutes		—	10	60	6	226
C-CES 2030-1200	2 Flutes		—	12	50	6	157
CRN-ES 2030-1200			—	12	55	6	174
C-CES 4030-1200	4 Flutes		—	12	50	6	208
DCES 4030-1200			—	12	50	6	222
CRN-ES 4030-1200	4 Flutes		—	12	55	6	220
CXES 4030-1200			—	12	60	6	197
HMS 3030-1500	3 Flutes		—	15	60	6	226
CXES 4030-1500	4 Flutes		—	15	60	6	197
CGE 4030			—	30	80	3	224
CZS 4031-0800	4 Flutes	3.1	—	8	60	6	183
C-CES 2031	2 Flutes		—	10	45	6	157
CZS 4032-0800	4 Flutes	3.2	—	8	60	6	183
C-CES 2032	2 Flutes		—	10	45	6	157
CZS 4033-0800	4 Flutes	3.3	—	8	60	6	183
C-CES 2033	2 Flutes		—	10	45	6	157
CZS 4034-0800	4 Flutes	3.4	—	8	60	6	183
C-CES 2034	2 Flutes		—	10	45	6	157
C-CER 2035-12	2 Flutes	3.5	12	5	50	6	247
C-CER 2035-15	2 Flutes	3.5	15	5	60	6	247
C-CER 2035-16			16	5	60	6	247
C-CER 2035-20	2 Flutes	3.5	20	5	60	6	247
C-CER 2035-25			25	5	70	6	247
C-CER 2035-30	2 Flutes	3.5	30	5	70	6	247
C-CER 2035-35			35	5	80	6	247
AZS 3035-105	3 Flutes	3.5	10.5	7	70	6	267
DLC-AZS 3035-105			10.5	7	70	6	271
CXES 4035-0900	4 Flutes		—	9	60	6	197
C-CES 2035	2 Flutes		—	10	45	6	157
C-CES 4035	4 Flutes	3.6	—	10	45	6	208
CZS 4035-1000			—	10	60	6	183
C-CES 2036	2 Flutes	3.6	—	10	45	6	157
CZS 4036-1000	4 Flutes		—	10	60	6	183
C-CES 2037	2 Flutes	3.7	—	10	45	6	157
CZS 4037-1000	4 Flutes		—	10	60	6	183
CZS 4038-1000	4 Flutes	3.8	—	10	60	6	183
C-CES 2038	2 Flutes		—	11	45	6	157
CZS 4039-1000	4 Flutes	3.9	—	10	60	6	183
C-CES 2039	2 Flutes		—	11	45	6	157
CSS 2040-0400	2 Flutes		—	4	50	6	142
HLS 4040-120	4 Flutes	4	12	4	50	6	278
HLS 4040-160			16	4	60	6	278
HLS 4040-200	4 Flutes	4	20	4	60	6	278
HLS 4040-250			25	4	70	6	278
HLS 4040-300	4 Flutes	4	30	4	70	6	278
HLS 4040-350			35	4	80	6	278
HLS 4040-400	4 Flutes	4	40	4	90	6	278
HLS 4040-450			45	4	90	6	278
HLS 4040-500	4 Flutes	4	50	4	100	6	278
CSS 2040-0600			—	6	50	6	142
C-CES 2040-0600	2 Flutes	4	—	6	50	6	157
C-CES 2040-0600S			—	6	50	6	169
CAS 2040-0600	2 Flutes	4	—	6	50	6	180
CPS 2040SS			—	6	60	4	178
HLS 2040-120	2 Flutes	4	12	6	50	6	235
C-CER 2040-12			12	6	50	6	247
HLS 2040-160	2 Flutes	4	16	6	60	6	235
C-CER 2040-16			16	6	60	6	247
HLS 2040-200	2 Flutes	4	20	6	60	6	235

Simplified Table

Square

Model Number	Number of Flutes	Outside Diameter	Effective Length	Length of Cut	Overall Length	Shank Diameter	Page	Model Number	Number of Flutes	Outside Diameter	Effective Length	Length of Cut	Overall Length	Shank Diameter	Page	
C-CER 2040-20	2 Flutes	4	20	6	60	6	247	DLC-AZS 3040-200	3 Flutes	4	20	8	70	6	271	
HLS 2040-250			25	6	70	6	235	HMS 4040-0800	4 Flutes		—	8	50	6	226	
C-CER 2040-25			25	6	70	6	247	CSS 2040-1000	2 Flutes		—	10	50	6	142	
HLS 2040-300			30	6	70	6	235	C-CES 2040-1000			—	10	50	6	157	
C-CER 2040-30			30	6	70	6	247	CXES 4040-1000	4 Flutes		—	10	50	6	197	
HLS 2040-350			35	6	80	6	235	C-CES 2040	2 Flutes		—	11	45	6	157	
C-CER 2040-35			35	6	80	6	247	C-CES 4040			—	11	45	6	209	
HLS 2040-400			40	6	90	6	235	C-CES 4040S	4 Flutes		—	11	45	6	214	
C-CER 2040-40			40	6	90	6	247	CZS 4040-1100			—	11	60	6	183	
HLS 2040-450			45	6	90	6	235	CSS 2040-1200	4		—	12	50	6	142	
C-CER 2040-45			45	6	90	6	247	C-CES 2040-1200			—	12	50	6	157	
HLS 2040-500			50	6	100	6	235	C-CES 2040-1200S			—	12	50	6	169	
C-CER 2040-50			50	6	100	6	247	CRN-ES 2040-1200			2 Flutes	—	12	50	6	174
HLS 2040-600			60	6	110	6	235	DCES 2040-1200				—	12	50	6	176
CZS 4040-0800			—	6	60	6	183	CAS 2040-1200			4	—	12	50	6	180
CXS 4040-120			12	6	50	6	283	CPS 2040				—	12	60	6	178
CXS 4040-170			17	6	70	6	283	DCES 4040-1200			4 Flutes	—	12	50	6	222
CXS 4040-210			21	6	70	6	283	CRN-ES 4040-1200				—	12	50	6	220
CSS 2040-0800			—	8	50	6	142	CXES 4040-1200			4 Flutes	—	12	60	6	197
C-CES 2040-0800			—	8	50	6	157	C-CES 4040-1200				—	12	60	6	209
CPS 2040SSL	—	8	100	4	178	HMS 4040-1200	4	—		12	60	6	226			
CPR 2040-12	12	8	70	6	259	CRN-ES 2040-1600		2 Flutes		—	16	55	6	174		
CPR 2040-16	16	8	70	6	259	C-CES 2040-1600				—	16	60	6	157		
CPR 2040-18	18	8	70	6	259	CRN-ES 4040-1600		4 Flutes		—	16	55	6	220		
CPRL 2040-18	18	8	100	6	263	CXES 4040-1600				—	16	60	6	197		
DCLS 2040-210	21	8	70	6	255	C-CES 4040-1600		4 Flutes		—	16	60	6	209		
CPR 2040-21	21	8	70	6	259	DCES 4040-1600				—	16	60	6	222		
CPR 2040-24	24	8	70	6	259	CXES 4040-2000		4		—	20	60	6	197		
CPRL 2040-24	24	8	100	6	263	HMS 4040-2000				—	20	70	6	226		
DCLS 2040-260	26	8	70	6	255	CGE 4040		4	—	30	90	4	224			
DCLS 2040-320	32	8	70	6	255	C-CES 2041			2 Flutes	—	11	45	6	157		
CPR 2040-32	32	8	70	6	259	CZS 4041-1100				4 Flutes	4.1	—	11	60	6	183
CPRL 2040-32	32	8	100	6	263	C-CES 2042			2 Flutes	4.2	—	11	45	6	157	
CPR 2040-36	36	8	70	6	259	CZS 4042-1100				4 Flutes	—	11	60	6	183	
DCLS 2040-420	42	8	80	6	255	C-CES 2043			2 Flutes	4.3	—	11	45	6	157	
CPR 2040-42	42	8	80	6	259	CZS 4043-1100				4 Flutes	—	11	60	6	183	
CPR 2040-52	52	8	100	6	259	C-CES 2044			2 Flutes	4.4	—	11	45	6	157	
AZS 3040-120	12	8	70	6	267	CZS 4044-1100				4 Flutes	—	11	60	6	183	
DLC-AZS 3040-120	12	8	70	6	271	AZS 3045-135			3 Flutes	4.5	13.5	9	70	6	267	
AZS 3040-200	20	8	70	6	267	DLC-AZS 3045-135				13.5	9	70	6	271		

Simplified Table

Square							
Model Number	Number of Flutes	Outside Diameter	Effective Length	Length of Cut	Overall Length	Shank Diameter	Page
C-CES 2045	2 Flutes	4.5	—	11	45	6	157
C-CES 4045	4 Flutes		—	11	45	6	209
CZS 4045-1100			—	11	60	6	183
CXES 4045-1150	2 Flutes	4.6	—	11.5	60	6	197
C-CES 2046	4 Flutes		—	11	45	6	157
CZS 4046-1100	2 Flutes	4.7	—	11	60	6	183
C-CES 2047	4 Flutes		—	11	45	6	157
CZS 4047-1100	2 Flutes	4.8	—	11	60	6	183
CZS 4048-1100	4 Flutes		—	11	60	6	183
C-CES 2048	2 Flutes	4.9	—	13	50	6	157
CZS 4049-1100	4 Flutes		—	11	60	6	183
C-CES 2049	2 Flutes	5	—	13	50	6	157
CSS 2050-0500	2 Flutes		—	5	50	6	142
HLS 4050-160	4 Flutes	5	16	5	60	6	278
HLS 4050-250			25	5	70	6	278
HLS 4050-350			35	5	80	6	278
HLS 4050-500	2 Flutes	5	50	5	110	6	278
CSS 2050-0750			—	7.5	50	6	142
C-CES 2050-0750	2 Flutes	5	—	7.5	50	6	158
C-CES 2050-0750S			—	7.5	50	6	169
CAS 2050-0750	2 Flutes	5	—	7.5	50	6	180
HLS 2050-160			16	7.5	60	6	235
C-CER 2050-16	2 Flutes	5	16	7.5	60	6	247
HLS 2050-200			20	7.5	60	6	235
C-CER 2050-20	2 Flutes	5	20	7.5	60	6	247
HLS 2050-250			25	7.5	60	6	235
C-CER 2050-25	2 Flutes	5	25	7.5	60	6	247
HLS 2050-300			30	7.5	80	6	235
C-CER 2050-30	2 Flutes	5	30	7.5	80	6	247
HLS 2050-350			35	7.5	80	6	235
C-CER 2050-35	2 Flutes	5	35	7.5	80	6	247
HLS 2050-400			40	7.5	80	6	235
C-CER 2050-40	2 Flutes	5	40	7.5	80	6	247
HLS 2050-500			50	7.5	110	6	235
C-CER 2050-50	2 Flutes	5	50	7.5	110	6	247
HLS 2050-600			60	7.5	120	6	235
CZS 4050-0750	4 Flutes	5.1	—	7.5	60	6	184
CXS 4050-150			15	7.5	50	6	283
CXS 4050-210			21	7.5	70	6	283
CXS 4050-260	4 Flutes	5.2	26	7.5	70	6	283
			26	7.5	70	6	283

Model Number	Number of Flutes	Outside Diameter	Effective Length	Length of Cut	Overall Length	Shank Diameter	Page
CSS 2050-1000	2 Flutes	5	—	10	50	6	142
C-CES 2050-1000			—	10	50	6	158
CPR 2050-16	2 Flutes	5	16	10	80	6	259
CPR 2050-22			22	10	80	6	259
CPR 2050-32	3 Flutes	5	32	10	80	6	259
AZS 3050-150			15	10	70	6	267
DLC-AZS 3050-150	3 Flutes	5	15	10	70	6	271
AZS 3050-250			25	10	70	6	267
DLC-AZS 3050-250	4 Flutes	5	25	10	70	6	271
HMS 4050-1000			—	10	50	6	226
C-CES 2050-1250	2 Flutes	5	—	12.5	50	6	158
CSS 2050-1250			—	12.5	60	6	142
CXES 4050-1250	4 Flutes	5	—	12.5	50	6	197
C-CES 4050-1250			—	12.5	50	6	209
C-CES 2050	2 Flutes	5	—	13	50	6	158
C-CES 4050			—	13	50	6	209
C-CES 4050S	4 Flutes	5	—	13	50	6	214
CZS 4050-1300			—	13	60	6	184
C-CES 2050-1500	2 Flutes	5	—	15	50	6	158
C-CES 2050-1500S			—	15	50	6	169
CAS 2050-1500	2 Flutes	5	—	15	50	6	180
CRN-ES 2050-1500			—	15	55	6	174
CSS 2050-1500	2 Flutes	5	—	15	60	6	142
CPS 2050			—	15	60	6	178
CRN-ES 4050-1500	4 Flutes	5	—	15	55	6	220
CXES 4050-1500			—	15	60	6	197
C-CES 4050-1500	4 Flutes	5	—	15	60	6	209
HMS 4050-1500			—	15	60	6	226
C-CES 2050-2000	2 Flutes	5	—	20	60	6	158
CXES 4050-2000			—	20	60	6	197
C-CES 4050-2000	4 Flutes	5	—	20	60	6	209
CXES 4050-2500			—	25	70	6	197
HMS 4050-2500	4 Flutes	5	—	25	70	6	226
CGE 4050			—	35	100	6	224
C-CES 2051	2 Flutes	5.1	—	13	50	6	158
CZS 4051-1300	4 Flutes		—	13	60	6	184
C-CES 2052	2 Flutes	5.2	—	13	50	6	158
CZS 4052-1300	4 Flutes		—	13	60	6	184
C-CES 2053	2 Flutes	5.3	—	13	50	6	158
CZS 4053-1300	4 Flutes		—	13	60	6	184

Simplified Table

Square

Model Number	Number of Flutes	Outside Diameter	Effective Length	Length of Cut	Overall Length	Shank Diameter	Page	
C-CES 2054	2 Flutes	5.4	—	13	50	6	158	
CZS 4054-1300	4 Flutes		—	13	60	6	184	
C-CES 2055	2 Flutes	5.5	—	13	50	6	158	
C-CES 4055	4 Flutes		—	13	50	6	209	
CZS 4055-1300		4 Flutes	—	13	60	6	184	
CXES 4055-1400	4 Flutes	5.6	—	14	60	6	197	
C-CES 2056	2 Flutes		—	13	50	6	158	
CZS 4056-1300	4 Flutes	5.7	—	13	60	6	184	
C-CES 2057	2 Flutes		—	13	50	6	158	
CZS 4057-1300	4 Flutes	5.8	—	13	60	6	184	
C-CES 2058	2 Flutes		—	13	50	6	158	
CZS 4058-1300	4 Flutes	5.9	—	13	60	6	184	
C-CES 2059	2 Flutes		—	13	50	6	158	
CZS 4059-1300	4 Flutes	6	—	6	50	6	142	
CSS 2060-0800	2 Flutes		—	6	50	6	142	
HLS 4060-200	4 Flutes	20	6	80	6	278		
HLS 4060-300		30	6	90	6	278		
HLS 4060-400		40	6	100	6	278		
HLS 4060-500		50	6	110	6	278		
CSS 2060-0900		—	9	50	6	142		
C-CES 2060-0900	2 Flutes	—	9	50	6	158		
C-CES 2060-0900S		—	9	50	6	169		
CAS 2060-0900		—	9	50	6	180		
HLS 2060-200		20	9	80	6	235		
C-CER 2060-20		20	9	80	6	247		
HLS 2060-300		30	9	80	6	235		
C-CER 2060-30		30	9	80	6	247		
HLS 2060-400		40	9	100	6	235		
C-CER 2060-40		40	9	100	6	247		
HLS 2060-500		50	9	120	6	235		
C-CER 2060-50	50	9	120	6	247			
HLS 2060-600	60	9	120	6	235			
C-CER 2060-60	60	9	120	6	247			
CZS 4060-0900	4 Flutes	—	9	60	6	184		
CESUS 4060-0900		—	9	60	6	217		
CXS 4060-180		18	9	50	6	283		
CXS 4060-260		26	9	70	6	283		
CXS 4060-320		32	9	70	6	283		
CSS 2060-1200	2 Flutes	—	12	50	6	142		
C-CES 2060-1200		—	12	50	6	158		
CPR 2060-12	2 Flutes	6	—	12	80	6	259	
DCLS 2060-320			32	12	80	6	255	
DCLS 2060-420			42	12	80	6	255	
CPR 2060-42			42	12	80	6	259	
CPR 2060-52			52	12	120	6	259	
DCLS 2060-630			63	12	120	6	255	
CPR 2060-63			63	12	120	6	259	
AZS 3060-180			3 Flutes	18	12	70	6	267
DLC-AZS 3060-180				18	12	70	6	271
AZS 3060-300				30	12	70	6	267
DLC-AZS 3060-300	30	12	70	6	271			
C-CES 2060	2 Flutes	—	13	50	6	158		
C-CES 4060	4 Flutes	—	13	50	6	209		
C-CES 4060S		—	13	50	6	214		
CZS 4060-1300		—	13	60	6	184		
CESUS 4060-1300	6 Flutes	—	13	60	6	217		
HMS 6060-1300		—	13	50	6	226		
C-CES 2060-1500	2 Flutes	—	15	50	6	158		
CAS 2060-1500		—	15	50	6	180		
CSS 2060-1500	4 Flutes	—	15	60	6	142		
CXES 4060-1500		—	15	50	6	197		
C-CES 4060-1500	2 Flutes	—	15	50	6	209		
C-CES 2060-1800		—	18	50	6	158		
C-CES 2060-1800S	2 Flutes	—	18	50	6	169		
CSS 2060-1800		—	18	60	6	142		
CRN-ES 2060-1800	2 Flutes	—	18	60	6	174		
DCES 2060-1800		—	18	60	6	176		
CPS 2060	4 Flutes	—	18	60	6	178		
CZS 4060-1800		—	18	60	6	184		
CXES 4060-1800	4 Flutes	—	18	60	6	197		
C-CES 4060-1800		—	18	60	6	209		
CESUS 4060-1800	6 Flutes	—	18	60	6	217		
DCES 4060-1800		—	18	60	6	222		
CRN-ES 4060-1800	2 Flutes	—	18	60	6	220		
DCES 4060-1800L		—	18	100	6	222		
HMS 6060-1800	2 Flutes	—	18	60	6	226		
C-CES 2060-2400		—	24	60	6	158		
CRN-ES 2060-2400	4 Flutes	—	24	65	6	174		
C-CES 4060-2400		—	24	60	6	209		
DCES 4060-2400	—	24	60	6	222			

Simplified Table

Square							
Model Number	Number of Flutes	Outside Diameter	Effective Length	Length of Cut	Overall Length	Shank Diameter	Page
CRN-ES 4060-2400	4 Flutes	6	—	24	65	6	220
CXES 4060-2400			—	24	70	6	197
HMS 6060-2600	6 Flutes		—	26	70	6	226
CXES 4060-3000	4 Flutes		—	30	80	6	197
CGE 4060			—	40	150	6	224
C-CES 2061	2 Flutes	6.1	—	16	60	8	158
C-CES 2062	2 Flutes	6.2	—	16	60	8	158
C-CES 2063	2 Flutes	6.3	—	16	60	8	158
C-CES 2064	2 Flutes	6.4	—	16	60	8	158
C-CES 2065	2 Flutes	6.5	—	16	60	8	158
C-CES 4065	4 Flutes		—	16	60	8	209
CZS 4065-1600			—	16	70	8	184
CXES 4065-1650	—	16.5	60	8	197		
C-CES 2066	2 Flutes	6.6	—	16	60	8	158
C-CES 2067	2 Flutes	6.7	—	16	60	8	158
C-CES 2068	2 Flutes	6.8	—	16	60	8	158
C-CES 2069	2 Flutes	6.9	—	16	60	8	158
CZS 4070-1050	4 Flutes	7	—	10.5	70	8	184
CESUS 4070-1050			—	10.5	70	8	217
CXES 4070-1050			—	10.5	100	6	197
AZS 3070-210	3 Flutes		21	14	80	8	267
DLC-AZS 3070-210			21	14	80	8	271
AZS 3070-350		35	14	80	8	267	
DLC-AZS 3070-350	35	14	80	8	271		
C-CES 2070	2 Flutes	—	16	60	8	158	
C-CES 4070	—	—	16	60	8	209	
CZS 4070-1600	4 Flutes	—	16	70	8	184	
CESUS 4070-1600	—	—	16	70	8	217	
CSS 2070-1750	2 Flutes	—	17.5	70	8	142	
CXES 4070-1750	4 Flutes	—	17.5	70	8	197	
CSS 2070-2100	2 Flutes	—	21	80	8	142	
CZS 4070-2100	4 Flutes	—	21	70	8	184	
CESUS 4070-2100		—	21	70	8	217	
C-CES 2071	2 Flutes	7.1	—	16	60	8	158
C-CES 2072	2 Flutes	7.2	—	16	60	8	158
C-CES 2073	2 Flutes	7.3	—	16	60	8	158
C-CES 2074	2 Flutes	7.4	—	16	60	8	158
C-CES 2075	2 Flutes	—	16	60	8	158	
C-CES 4075	4 Flutes	7.5	—	16	60	8	209
CZS 4075-1600			—	16	70	8	184
CXES 4075-1900	4 Flutes	7.5	—	19	60	8	197
C-CES 2076	2 Flutes	7.6	—	19	60	8	158
C-CES 2077	2 Flutes	7.7	—	19	60	8	158
C-CES 2078	2 Flutes	7.8	—	19	60	8	158
C-CES 2079	2 Flutes	7.9	—	19	60	8	158
CSS 2080-0800	2 Flutes	8	—	8	70	8	142
CSS 2080-1200			—	12	70	8	142
CAS 2080-1200	—		12	80	8	180	
CZS 4080-1200	4 Flutes		—	12	70	8	184
CESUS 4080-1200			—	12	70	8	217
CXS 4080-240		24	12	60	8	283	
CXS 4080-340	34	12	90	8	283		
CXS 4080-420	42	12	90	8	283		
C-CES 2080-1600	2 Flutes	—	16	60	8	159	
CSS 2080-1600		—	16	70	8	142	
AZS 3080-240	3 Flutes	24	16	80	8	267	
DLC-AZS 3080-240		24	16	80	8	271	
AZS 3080-400		40	16	80	8	267	
DLC-AZS 3080-400	40	16	80	8	271		
C-CES 2080	2 Flutes	—	19	60	8	159	
C-CES 4080	4 Flutes	—	19	60	8	209	
C-CES 4080S		—	19	60	8	214	
CZS 4080-1900		—	19	70	8	184	
CESUS 4080-1900		—	19	70	8	217	
HMS 6080-1900	6 Flutes	—	19	60	8	226	
C-CES 2080-2000	2 Flutes	—	20	60	8	159	
CSS 2080-2000		—	20	70	8	142	
CAS 2080-2000	4 Flutes	—	20	80	8	180	
CXES 4080-2000		—	20	60	8	197	
C-CES 4080-2000	—	20	60	8	209		
CSS 2080-2400	2 Flutes	—	24	80	8	142	
C-CES 2080-2400		—	24	80	8	159	
C-CES 2080-2400S	—	24	80	8	169		
CRN-ES 2080-2400	2 Flutes	—	24	80	8	174	
CPS 2080		—	24	80	8	178	
CZS 4080-2400	4 Flutes	—	24	70	8	184	
CXES 4080-2400		—	24	70	8	197	
CESUS 4080-2400		—	24	70	8	217	
C-CES 4080-2400		—	24	80	8	209	
DCES 4080-2400	—	24	80	8	222		

Simplified Table

Square

Model Number	Number of Flutes	Outside Diameter	Effective Length	Length of Cut	Overall Length	Shank Diameter	Page	
CRN-ES 4080-2400	4 Flutes	8	—	24	80	8	220	
HMS 6080-2400	6 Flutes		—	24	70	8	226	
C-CES 2080-3200	2 Flutes		—	32	80	8	159	
CXES 4080-3200	4 Flutes		—	32	80	8	197	
C-CES 4080-3200			—	32	80	8	209	
DCES 4080-3200	2 Flutes		—	32	80	8	222	
HMS 6080-3800	6 Flutes		—	36	90	8	226	
CXES 4080-4000	4 Flutes		—	40	90	8	197	
CGE 4080			—	40	150	8	224	
C-CES 2081	2 Flutes		8.1	—	19	70	10	159
C-CES 2082	2 Flutes		8.2	—	19	70	10	159
C-CES 2083	2 Flutes		8.3	—	19	70	10	159
C-CES 2084	2 Flutes		8.4	—	19	70	10	159
C-CES 2085	2 Flutes		8.5	—	19	70	10	159
C-CES 4085	4 Flutes	—		19	70	10	209	
CZS 4085-1900		—		19	80	10	184	
CXES 4085-2150	2 Flutes	—	21.5	70	10	197		
C-CES 2086	2 Flutes	8.6	—	19	70	10	159	
C-CES 2087	2 Flutes	8.7	—	19	70	10	159	
C-CES 2088	2 Flutes	8.8	—	19	70	10	159	
C-CES 2089	2 Flutes	8.9	—	19	70	10	159	
CZS 4090-1350	4 Flutes	9	—	13.5	80	10	184	
CESUS 4090-1350			—	13.5	80	10	217	
CXES 4090-1350			—	13.5	140	8	197	
AZS 3090-270			3 Flutes	27	18	90	10	267
DLC-AZS 3090-270	27			18	90	10	271	
AZS 3090-450	45			18	90	10	267	
DLC-AZS 3090-450	45			18	90	10	271	
C-CES 2090	2 Flutes		—	19	70	10	159	
C-CES 4090	4 Flutes		—	19	70	10	209	
CZS 4090-1900			—	19	80	10	184	
CESUS 4090-1900	2 Flutes		—	19	80	10	217	
CSS 2090-2250	2 Flutes		—	22.5	80	10	142	
CXES 4090-2250	4 Flutes		—	22.5	80	10	197	
CSS 2090-2700	2 Flutes		—	27	80	10	142	
CZS 4090-2700	4 Flutes	—	27	80	10	184		
CESUS 4090-2700		—	27	80	10	217		
C-CES 2091	2 Flutes	9.1	—	19	70	10	159	
C-CES 2092	2 Flutes	9.2	—	19	70	10	159	
C-CES 2093	2 Flutes	9.3	—	19	70	10	159	
C-CES 2094	2 Flutes	9.5	9.4	—	19	70	10	159
C-CES 2095	2 Flutes		—	19	70	10	159	
C-CES 4095	4 Flutes		—	19	70	10	209	
CZS 4095-1900			—	19	80	10	184	
CXES 4095-2400	2 Flutes		—	24	70	10	197	
C-CES 2096	2 Flutes		9.6	—	22	70	10	159
C-CES 2097	2 Flutes		9.7	—	22	70	10	159
C-CES 2098	2 Flutes		9.8	—	22	70	10	159
C-CES 2099	2 Flutes		9.9	—	22	70	10	159
CSS 2100-1000	2 Flutes		10	—	10	70	10	142
CSS 2100-1500				—	15	70	10	142
CAS 2100-1500				—	15	80	10	180
CZS 4100-1500	4 Flutes			—	15	80	10	184
CESUS 4100-1500				—	15	80	10	217
CXS 4100-300		30		15	70	10	283	
CXS 4100-420	42	15		100	10	283		
CXS 4100-520	52	15		100	10	283		
CSS 2100-2000	2 Flutes	—		20	70	10	142	
C-CES 2100-2000		—		20	70	10	159	
AZS 3100-300	3 Flutes	30		20	90	10	267	
DLC-AZS 3100-300		30		20	90	10	271	
AZS 3100-500		50		20	90	10	267	
DLC-AZS 3100-500	50	20		90	10	271		
C-CES 2100	2 Flutes	—	22	70	10	159		
C-CES 4100	4 Flutes	—	22	70	10	209		
C-CES 4100S		—	22	70	10	214		
CZS 4100-2200		—	22	80	10	184		
CESUS 4100-2200		—	22	80	10	217		
HMS 6100-2200	6 Flutes	—	22	70	10	226		
C-CES 2100-2500	2 Flutes	—	25	70	10	159		
CSS 2100-2500		—	25	80	10	142		
CAS 2100-2500	4 Flutes	—	25	80	10	180		
CXES 4100-2500		—	25	70	10	197		
C-CES 4100-2500	2 Flutes	—	25	70	10	209		
CSS 2100-3000		—	30	80	10	142		
C-CES 2100-3000		—	30	80	10	159		
C-CES 2100-3000S	2 Flutes	—	30	80	10	169		
CPS 2100		—	30	80	10	178		
CRN-ES 2100-3000	4 Flutes	—	30	100	10	174		
CZS 4100-3000		—	30	80	10	184		

Simplified Table

Square									
Model Number	Number of Flutes	Outside Diameter	Effective Length	Length of Cut	Overall Length	Shank Diameter	Page		
CXES	4100-3000	4 Flutes	10	—	30	80	10	197	
CESUS	4100-3000			—	30	80	10	217	
C-CES	4100-3000			—	30	90	10	209	
DCES	4100-3000			—	30	90	10	222	
CRN-ES	4100-3000			—	30	100	10	220	
HMS	6100-3000			6 Flutes	—	30	80	10	226
C-CES	2100-4000			2 Flutes	—	40	90	10	159
CRN-ES	2100-4000			—	40	100	10	174	
CXES	4100-4000			4 Flutes	—	40	90	10	197
C-CES	4100-4000				—	40	90	10	209
DCES	4100-4000	—	40		90	10	222		
CGE	4100	—	45		180	10	224		
HMS	6100-4600	6 Flutes	—	46	100	10	226		
CXES	4100-5000	4 Flutes	—	50	100	10	197		
C-CES	2105	2 Flutes	10.5	—	22	75	12	159	
C-CES	4105	4 Flutes		—	22	75	12	209	
CZS	4105-2200	—		22	100	12	184		
CZS	4110-1650	4 Flutes	11	—	16.5	100	12	184	
CESUS	4110-1650			—	16.5	100	12	217	
CXES	4110-1650			—	16.5	150	10	197	
C-CES	2110			2 Flutes	—	22	75	12	159
AZS	3110-330	3 Flutes	33	22	110	12	267		
DLC-AZS	3110-330		33	22	110	12	271		
AZS	3110-550		55	22	110	12	267		
DLC-AZS	3110-550		55	22	110	12	271		
C-CES	4110	4 Flutes	—	22	75	12	209		
CZS	4110-2200		—	22	100	12	184		
CESUS	4110-2200	—	22	100	12	217			
CSS	2110-2750	2 Flutes	—	27.5	80	12	142		
CXES	4110-2750	4 Flutes	—	27.5	100	12	197		
CSS	2110-3300	2 Flutes	—	33	80	12	142		
CZS	4110-3300	4 Flutes	—	33	100	12	184		
CESUS	4110-3300		—	33	100	12	217		
C-CES	2115	2 Flutes	11.5	—	22	75	12	159	
C-CES	4115	4 Flutes		—	22	75	12	209	
CZS	4115-2200	—		22	100	12	185		
CSS	2120-1200	2 Flutes	12	—	12	80	12	142	
CSS	2120-1800			—	18	80	12	142	
CAS	2120-1800			—	18	90	12	180	
CZS	4120-1800			4 Flutes	—	18	100	12	185
CESUS	4120-1800	4 Flutes	13	—	18	100	12	217	
CXS	4120-360			36	18	90	12	283	
CXS	4120-520			52	18	110	12	283	
CXS	4120-620			62	18	110	12	283	
C-CES	2120-2400	2 Flutes	—	24	75	12	159		
CSS	2120-2400		—	24	80	12	142		
AZS	3120-360	3 Flutes	36	24	110	12	267		
DLC-AZS	3120-360		36	24	110	12	271		
AZS	3120-600		60	24	110	12	267		
DLC-AZS	3120-600	60	24	110	12	271			
C-CES	2120	2 Flutes	—	26	75	12	159		
C-CES	4120	4 Flutes	—	26	75	12	209		
C-CES	4120S		—	26	75	12	214		
CZS	4120-2600		—	26	100	12	185		
CESUS	4120-2600		—	26	100	12	217		
HMS	6120-2600	6 Flutes	—	26	75	12	226		
C-CES	2120-3000	2 Flutes	—	30	75	12	159		
CSS	2120-3000		—	30	80	12	142		
CAS	2120-3000	4 Flutes	—	30	90	12	180		
C-CES	4120-3000		—	30	75	12	209		
CXES	4120-3000		—	30	90	12	197		
CSS	2120-3600		—	36	90	12	142		
C-CES	2120-3600	2 Flutes	—	36	90	12	159		
C-CES	2120-3600S		—	36	90	12	169		
CPS	2120	—	36	90	12	178			
CRN-ES	2120-3600	—	36	100	12	174			
C-CES	4120-3600	4 Flutes	—	36	90	12	209		
CZS	4120-3600		—	36	100	12	185		
CXES	4120-3600		—	36	100	12	197		
CESUS	4120-3600		—	36	100	12	217		
CRN-ES	4120-3600	—	36	100	12	220			
HMS	6120-3600	6 Flutes	—	36	100	12	226		
C-CES	2120-4800	2 Flutes	—	48	100	12	159		
C-CES	4120-4800	4 Flutes	—	48	100	12	209		
CXES	4120-4800		—	48	110	12	197		
C-CES	4120-5000		—	50	100	12	209		
CGE	4120	—	55	200	12	224			
HMS	6120-5600	6 Flutes	—	56	120	12	226		
CXES	4120-6000	4 Flutes	—	60	120	12	197		
CXES	4130-1950	4 Flutes	—	19.5	160	12	197		

Simplified Table

Square

Model Number	Number of Flutes	Outside Diameter	Effective Length	Length of Cut	Overall Length	Shank Diameter	Page		
CZS	4130-2600	4 Flutes	13	—	26	110	12	185	
C-CES	4140	4 Flutes	14	—	26	80	12	209	
CZS	4160-2400	4 Flutes	16	—	24	110	16	185	
C-CES	2160	2 Flutes		—	32	110	16	159	
CZS	4160-3200	4 Flutes		—	32	110	16	185	
C-CES	4160			—	32	110	16	209	
CXES	4160-4000			—	40	110	16	197	
CGE	4160			—	70	200	16	224	
C-CES	2180	2 Flutes		18	—	32	110	20	159
C-CES	4180	4 Flutes			—	32	110	20	209
CZS	4200-3000	4 Flutes	20	—	30	125	20	185	
C-CES	2200	2 Flutes		—	38	110	20	159	
C-CES	4200	4 Flutes		—	38	110	20	209	
CZS	4200-4000			—	40	125	20	185	
CGE	4200			—	70	200	20	224	

Simplified Table

Ball							
Model Number	Number of Flutes	Radius of Ball Nose	Effective Length	Length of Cut	Overall Length	Shank Diameter	Page
HSB	20006-0006	2 Flutes	RO.03	—	0.06	50	4 398
HSB	20008-0008	2 Flutes	RO.04	—	0.08	50	4 398
HSB	1001-0020-6	1 Flutes	RO.05	—	0.2	50	6 398
CSEB	1001-0020-6			—	0.2	50	6 406
HGB	2001-0010	2 Flutes	RO.05	—	0.1	50	4 396
HSB	2001-0010			—	0.1	50	4 398
CSEB	2001-0010			—	0.1	50	4 406
HGLB	2001-002			0.2	0.08	45	4 437
HSLB	2001-002			0.2	0.08	45	4 446
CSELB	2001-002			0.2	0.08	45	4 468
CBN-LBSF	2001-003			0.3	0.07	50	4 114
HGLB	2001-003			0.3	0.08	45	4 437
HSLB	2001-003			0.3	0.08	45	4 446
CSELB	2001-003			0.3	0.08	45	4 468
DLCLB	2001-003	0.3	0.08	45	4 488		
CBN-LBF	2001-003	0.3	0.08	50	4 120		
CBN-LBSF	2001-005	0.5	0.07	50	4 114		
HGLB	2001-005	0.5	0.08	45	4 437		
HSLB	2001-005	0.5	0.08	45	4 446		
CSELB	2001-005	0.5	0.08	45	4 468		
DLCLB	2001-005	0.5	0.08	45	4 488		
CBN-LBF	2001-005	0.5	0.08	50	4 120		
HGB	20015-0015	2 Flutes	RO.075	—	0.15	50	4 396
HGLB	20015-003			0.3	0.12	45	4 437
HSLB	20015-003			0.3	0.12	45	4 446
CSELB	20015-003			0.3	0.12	45	4 468
DLCLB	20015-003			0.3	0.12	45	4 488
CBN-LBSF	20015-0045			0.45	0.1	50	4 114
CBN-LBF	20015-0045			0.45	0.15	50	4 120
HGLB	20015-005			0.5	0.12	45	4 437
HSLB	20015-005			0.5	0.12	45	4 446
CSELB	20015-005			0.5	0.12	45	4 468
DLCLB	20015-005	0.5	0.12	45	4 488		
CBN-LBSF	20015-0075	0.75	0.1	50	4 114		
HGLB	20015-0075	0.75	0.12	45	4 437		
CBN-LBF	20015-0075	0.75	0.15	50	4 120		
HGLB	20015-010	1	0.12	45	4 437		
HSLB	20015-010	1	0.12	45	4 446		
CSELB	20015-010	1	0.12	45	4 468		
DLCLB	20015-010	1	0.12	45	4 488		
UDCBF	2002-0014	2 Flutes	RO.1	—	0.14	50	4 80
UDCB	2002-0014			—	0.14	50	4 94
HSB	2002-0020S			—	0.2	35	4 403
HSB	2002-0020-6			—	0.2	50	6 398
CSEB	2002-0020-6			—	0.2	50	6 406
HGB	2002-0030			—	0.3	50	4 396
HSB	2002-0030			—	0.3	50	4 398
CSEB	2002-0030			—	0.3	50	4 406
CBN-LBSF	2002-003			0.3	0.13	50	4 114
UDCLBF	2002-0030			0.3	0.14	50	4 82
UDCLB	2002-0030	0.3	0.14	50	4 98		
HGLB	2002-003	0.3	0.16	45	4 437		
HSLB	2002-003	0.3	0.16	45	4 447		
CSELB	2002-003	0.3	0.16	45	4 469		
DLCLB	2002-003	0.3	0.16	45	4 488		
CBN-LBF	2002-003	0.3	0.16	50	4 120		
UPDLB	1002-004	1 Flutes	RO.1	0.4	0.1	40	4 434
UDCLBF	2002-0050	2 Flutes	RO.1	0.5	0.14	50	4 82
UDCLB	2002-0050			0.5	0.14	50	4 98
HSLB	2002-005S			0.5	0.16	35	4 465
HGLB	2002-005			0.5	0.16	45	4 437
HSLB	2002-005			0.5	0.16	45	4 447
CSELB	2002-005			0.5	0.16	45	4 469
DLCLB	2002-005			0.5	0.16	45	4 488
HSLB	2002-005-6			0.5	0.16	50	6 447
CSELB	2002-005-6			0.5	0.16	50	6 469
CBN-LBSF	2002-006			0.6	0.13	50	4 114
CBN-LBF	2002-006	0.6	0.16	50	4 120		
UDCLBF	2002-0075	0.75	0.14	50	4 82		
UDCLB	2002-0075	0.75	0.14	50	4 98		
HGLB	2002-0075	0.75	0.16	45	4 437		
HSLB	2002-0075	0.75	0.16	45	4 447		
CSELB	2002-0075	0.75	0.16	45	4 469		
UDCLBF	2002-0100	1	0.14	50	4 82		
UDCLB	2002-0100	1	0.14	50	4 98		
HSLB	2002-010S	1	0.16	35	4 465		
HGLB	2002-010	1	0.16	45	4 437		
HSLB	2002-010	1	0.16	45	4 447		
CSELB	2002-010	1	0.16	45	4 469		
DLCLB	2002-010	1	0.16	45	4 488		

Simplified Table

Ball

Model Number	Number of Flutes	Radius of Ball Nose	Effective Length	Length of Cut	Overall Length	Shank Diameter	Page	Model Number	Number of Flutes	Radius of Ball Nose	Effective Length	Length of Cut	Overall Length	Shank Diameter	Page		
CBN-LBF 2002-010	2 Flutes	R0.1	1	0.16	50	4	120	CSELB 2003-005	2 Flutes	R0.15	0.5	0.24	45	4	469		
HSLB 2002-010-6			1	0.16	50	6	447	CBN-LBF 2003-005			0.5	0.24	50	4	120		
CSELB 2002-010-6			1	0.16	50	6	469	HSLB 2003-006			0.6	0.24	45	4	447		
HSLB 2002-0125			1.25	0.16	45	4	447	CSELB 2003-006			0.6	0.24	45	4	469		
CSELB 2002-0125			1.25	0.16	45	4	469	DLCLB 2003-006			0.6	0.24	45	4	488		
HGLB 2002-015			1.5	0.16	45	4	437	UDCLBF 2003-0075			0.75	0.21	50	4	82		
HSLB 2002-015			1.5	0.16	45	4	447	CBN-LBSF 2003-0075			0.75	0.22	50	4	115		
CSELB 2002-015			1.5	0.16	45	4	469	HSLB 2003-0075S			0.75	0.24	35	4	465		
DLCLB 2002-015			1.5	0.16	45	4	488	HGLB 2003-0075			0.75	0.24	45	4	437		
HSLB 2002-015-6			1.5	0.16	50	6	447	HSLB 2003-0075			0.75	0.24	45	4	447		
CSELB 2002-015-6			1.5	0.16	50	6	469	CSELB 2003-0075			0.75	0.24	45	4	469		
HSLB 2002-0175			1.75	0.16	45	4	447	CBN-LBF 2003-0075			0.75	0.24	50	4	120		
CSELB 2002-0175			1.75	0.16	45	4	469	CBN-LBSF 2003-009			0.9	0.22	50	4	115		
HGLB 2002-020			2	0.16	45	4	437	CBN-LBF 2003-009			0.9	0.24	50	4	120		
HSLB 2002-020			2	0.16	45	4	447	UDCLBF 2003-0100			1	0.21	50	4	82		
CSELB 2002-020			2	0.16	45	4	469	HSLB 2003-010S			1	0.24	35	4	465		
HSLB 2002-020-6			2	0.16	50	6	447	HGLB 2003-010			1	0.24	45	4	437		
CSELB 2002-020-6			2	0.16	50	6	469	HSLB 2003-010			1	0.24	45	4	447		
HSLB 2002-0225			2.25	0.16	45	4	447	CSELB 2003-010			1	0.24	45	4	469		
CSELB 2002-0225			2.25	0.16	45	4	469	DLCLB 2003-010			1	0.24	45	4	488		
HSLB 2002-025			2.5	0.16	45	4	447	HSLB 2003-010-6			1	0.24	50	6	447		
CSELB 2002-025			2.5	0.16	45	4	469	CSELB 2003-010-6			1	0.24	50	6	469		
HSLB 2002-030			3	0.16	45	4	447	HSLB 2003-0125			1.25	0.24	45	4	447		
CSELB 2002-030			3	0.16	45	4	469	CSELB 2003-0125			1.25	0.24	45	4	469		
UDCBF 2003-0021			2 Flutes	R0.15	—	0.21	50	4			80	HSLB 2003-015S	1.5	0.24	35	4	465
UDCB 2003-0021					—	0.21	50	4			94	HGLB 2003-015	1.5	0.24	45	4	437
HSB 2003-0030S					—	0.3	35	4			403	HSLB 2003-015	1.5	0.24	45	4	447
HGB 2003-0030					—	0.3	50	4			396	CSELB 2003-015	1.5	0.24	45	4	469
HSB 2003-0030					—	0.3	50	4			398	DLCLB 2003-015	1.5	0.24	45	4	488
CSEB 2003-0030					—	0.3	50	4			406	CBN-LBF 2003-015	1.5	0.24	50	4	120
HSB 2003-0030-6					—	0.3	50	6			398	HSLB 2003-015-6	1.5	0.24	50	6	447
CSEB 2003-0030-6					—	0.3	50	6			406	CSELB 2003-015-6	1.5	0.24	50	6	469
HGB 2003-0045	—	0.45			50	4	396	HSLB 2003-0175	1.75	0.24	45	4	447				
HSB 2003-0045	—	0.45			50	4	398	CSELB 2003-0175	1.75	0.24	45	4	469				
CSEB 2003-0045	—	0.45			50	4	406	HGLB 2003-020	2	0.24	45	4	437				
UDCLBF 2003-0050	0.5	0.21			50	4	82	HSLB 2003-020	2	0.24	45	4	447				
CBN-LBSF 2003-005	0.5	0.22			50	4	115	CSELB 2003-020	2	0.24	45	4	469				
HSLB 2003-005S	0.5	0.24			35	4	465	DLCLB 2003-020	2	0.24	45	4	488				
HGLB 2003-005	0.5	0.24			45	4	437	HSLB 2003-020-6	2	0.24	50	6	447				
HSLB 2003-005	0.5	0.24			45	4	447	CSELB 2003-020-6	2	0.24	50	6	469				

Simplified Table

Ball																	
Model Number	Number of Flutes	Radius of Ball Nose	Effective Length	Length of Cut	Overall Length	Shank Diameter	Page	Model Number	Number of Flutes	Radius of Ball Nose	Effective Length	Length of Cut	Overall Length	Shank Diameter	Page		
HSLB	2003-0225	2 Flutes	R0.15	2.25	0.24	45	4 447	HGLB	2004-010	2 Flutes	R0.2	1	0.32	45	4 437		
CSELB	2003-0225			2.25	0.24	45	4 469	HSLB	2004-010			1	0.32	45	4 447		
HGLB	2003-025			2.5	0.24	45	4 437	CSELB	2004-010			1	0.32	45	4 469		
HSLB	2003-025			2.5	0.24	45	4 447	DLCLB	2004-010			1	0.32	45	4 488		
CSELB	2003-025			2.5	0.24	45	4 469	CBN-LBSF	2004-010			1	0.32	50	4 115		
HGLB	2003-030			3	0.24	45	4 437	CBN-LBF	2004-010			1	0.32	50	4 121		
HSLB	2003-030			3	0.24	45	4 447	HGLB	2004-010-6			1	0.32	50	6 437		
CSELB	2003-030			3	0.24	45	4 469	HSLB	2004-010-6			1	0.32	50	6 447		
HSLB	2003-040			4	0.24	45	4 447	CSELB	2004-010-6			1	0.32	50	6 469		
CSELB	2003-040			4	0.24	45	4 469	CPRB	2004-1			1	0.4	45	4 498		
HSLB	2003-050			5	0.24	45	4 447	CBN-LBSF	2004-012			1.2	0.32	50	4 115		
CSELB	2003-050			5	0.24	45	4 469	CBN-LBF	2004-012			1.2	0.32	50	4 121		
UDCBF	2004-0028			2 Flutes	R0.2	—	0.28	50	4 80			HGLB	2004-0125	1.25	0.32	45	4 437
UDCB	2004-0028					—	0.28	50	4 94			HSLB	2004-0125	1.25	0.32	45	4 447
HSB	2004-0040S					—	0.4	35	4 403			CSELB	2004-0125	1.25	0.32	45	4 469
HGB	2004-0040	—	0.4			50	4 396	UDCLBF	2004-0150			1.5	0.28	50	4 82		
HSB	2004-0040	—	0.4			50	4 398	UDCLB	2004-0150			1.5	0.28	50	4 98		
CSEB	2004-0040	—	0.4			50	4 406	HSLB	2004-015S			1.5	0.32	35	4 465		
HSB	2004-0040-6	—	0.4			50	6 398	HGLB	2004-015			1.5	0.32	45	4 437		
CSEB	2004-0040-6	—	0.4			50	6 406	HSLB	2004-015			1.5	0.32	45	4 447		
HGB	2004-0060	—	0.6			50	4 396	CSELB	2004-015			1.5	0.32	45	4 469		
HSB	2004-0060	—	0.6			50	4 398	HGLB	2004-015-6			1.5	0.32	50	6 437		
CSEB	2004-0060	—	0.6			50	4 406	HSLB	2004-015-6			1.5	0.32	50	6 447		
CGB	2004	—	0.8			60	4 414	CSELB	2004-015-6			1.5	0.32	50	6 469		
UDCLBF	2004-0050	2 Flutes	R0.2			0.5	0.28	50	4 82			HSLB	2004-0175	1.75	0.32	45	4 447
UDCLB	2004-0050					0.5	0.28	50	4 98			CSELB	2004-0175	1.75	0.32	45	4 469
HSLB	2004-005S					0.5	0.32	35	4 465			UDCLBF	2004-0200	2	0.28	50	4 82
HGLB	2004-005					0.5	0.32	45	4 437			UDCLB	2004-0200	2	0.28	50	4 98
HSLB	2004-005					0.5	0.32	45	4 447			HSLB	2004-020S	2	0.32	35	4 465
CSELB	2004-005					0.5	0.32	45	4 469			HGLB	2004-020	2	0.32	45	4 437
CBN-LBF	2004-005					0.5	0.32	50	4 121	HSLB	2004-020	2	0.32	45	4 447		
HGLB	2004-0075					0.75	0.32	45	4 437	CSELB	2004-020	2	0.32	45	4 469		
HSLB	2004-0075					0.75	0.32	45	4 447	DCLB	2004-0020	2	0.32	45	4 484		
CSELB	2004-0075					0.75	0.32	45	4 469	DLCLB	2004-020	2	0.32	45	4 488		
CBN-LBSF	2004-0075					0.75	0.32	50	4 115	CBN-LBF	2004-020	2	0.32	50	4 121		
CBN-LBF	2004-0075					0.75	0.32	50	4 121	HGLB	2004-020-6	2	0.32	50	6 437		
UPDLB	1004-008					1 Flutes		0.8	0.2	40	4 434	HSLB	2004-020-6	2	0.32	50	6 447
UDCLBF	2004-0100					2 Flutes		1	0.28	50	4 82	CSELB	2004-020-6	2	0.32	50	6 469
UDCLB	2004-0100						1	0.28	50	4 98	CPRB	2004-2	2	0.4	45	4 498	
HSLB	2004-010S	1	0.32				35	4 465	HSLB	2004-0225	2.25	0.32	45	4 447			

Simplified Table

Ball

Model Number	Number of Flutes	Radius of Ball Nose	Effective Length	Length of Cut	Overall Length	Shank Diameter	Page	Model Number	Number of Flutes	Radius of Ball Nose	Effective Length	Length of Cut	Overall Length	Shank Diameter	Page		
CSELB	2004-0225	2 Flutes	R0.2	2.25	0.32	45	4 469	HSB	2005-0050	2 Flutes	R0.25	—	0.5	50	4 398		
UDCLBF	2004-0250			2.5	0.28	50	4 82	CSEB	2005-0050			—	0.5	50	4 406		
HSLB	2004-025S			2.5	0.32	35	4 465	HSB	2005-0050-6			—	0.5	50	6 398		
HGLB	2004-025			2.5	0.32	45	4 437	CSEB	2005-0050-6			—	0.5	50	6 406		
HSLB	2004-025			2.5	0.32	45	4 447	HGB	2005-0075			—	0.75	50	4 396		
CSELB	2004-025			2.5	0.32	45	4 469	HSB	2005-0075			—	0.75	50	4 398		
HGLB	2004-025-6			2.5	0.32	50	6 437	CSEB	2005-0075			—	0.75	50	4 406		
HSLB	2004-025-6			2.5	0.32	50	6 447	HSLB	2005-010S			1	0.4	35	4 465		
CSELB	2004-025-6			2.5	0.32	50	6 469	HGLB	2005-010			1	0.4	45	4 437		
HSLB	2004-030S			3	0.32	35	4 465	HSLB	2005-010			1	0.4	45	4 448		
HGLB	2004-030			3	0.32	45	4 437	CSELB	2005-010			1	0.4	45	4 470		
HSLB	2004-030			3	0.32	45	4 447	DLCLB	2005-010			1	0.4	45	4 488		
CSELB	2004-030			3	0.32	45	4 469	CBN-LBSF	2005-010			1	0.4	50	4 115		
DCLB	2004-030			3	0.32	45	4 484	CBN-LBF	2005-010			1	0.4	50	4 121		
DLCLB	2004-030			3	0.32	45	4 488	HSLB	2005-0125			1.25	0.4	45	4 448		
CBN-LBF	2004-030			3	0.32	50	4 121	CSELB	2005-0125			1.25	0.4	45	4 470		
HGLB	2004-030-6			3	0.32	50	6 437	HSLB	2005-015S			1.5	0.4	35	4 465		
HSLB	2004-030-6			3	0.32	50	6 447	HGLB	2005-015			1.5	0.4	45	4 437		
CSELB	2004-030-6			3	0.32	50	6 469	HSLB	2005-015			1.5	0.4	45	4 448		
CPRB	2004-3			3	0.4	45	4 498	CSELB	2005-015			1.5	0.4	45	4 470		
HGLB	2004-035			3.5	0.32	45	4 437	CBN-LBSF	2005-015			1.5	0.4	50	4 115		
HSLB	2004-035			3.5	0.32	45	4 447	CBN-LBF	2005-015			1.5	0.4	50	4 121		
CSELB	2004-035			3.5	0.32	45	4 469	HSLB	2005-015-6			1.5	0.4	50	6 448		
HGLB	2004-040			4	0.32	45	4 437	CSELB	2005-015-6			1.5	0.4	50	6 470		
HSLB	2004-040			4	0.32	45	4 447	HSLB	2005-0175			1.75	0.4	45	4 448		
CSELB	2004-040			4	0.32	45	4 469	CSELB	2005-0175			1.75	0.4	45	4 470		
DCLB	2004-040			4	0.32	45	4 484	HSLB	2005-020S			2	0.4	35	4 465		
DLCLB	2004-040			4	0.32	45	4 488	HGLB	2005-020			2	0.4	45	4 437		
HSLB	2004-040-6			4	0.32	50	6 447	HSLB	2005-020			2	0.4	45	4 448		
CSELB	2004-040-6			4	0.32	50	6 469	CSELB	2005-020			2	0.4	45	4 470		
HSLB	2004-045			4.5	0.32	45	4 447	DCLB	2005-0020			2	0.4	45	4 484		
CSELB	2004-045			4.5	0.32	45	4 469	DLCLB	2005-020			2	0.4	45	4 488		
HSLB	2004-050			5	0.32	45	4 447	HSLB	2005-020-6			2	0.4	50	6 448		
CSELB	2004-050			5	0.32	45	4 469	CSELB	2005-020-6			2	0.4	50	6 470		
DCLB	2004-0050			5	0.32	45	4 484	CPRB	2005-2			2	0.8	45	4 498		
HSLB	2004-060			6	0.32	45	4 447	HSLB	2005-0225			2.25	0.4	45	4 448		
CSELB	2004-060			6	0.32	45	4 469	CSELB	2005-0225			2.25	0.4	45	4 470		
UDCBF	2005-0035			2 Flutes	R0.25	—	0.35	50	4 80			HSLB	2005-025S	2.5	0.4	35	4 465
UDCB	2005-0035					—	0.35	50	4 94			HGLB	2005-025	2.5	0.4	45	4 437
HGB	2005-0050					—	0.5	50	4 396			HSLB	2005-025	2.5	0.4	45	4 448

Simplified Table

Ball							
Model Number	Number of Flutes	Radius of Ball Nose	Effective Length	Length of Cut	Overall Length	Shank Diameter	Page
CSELB 2005-025	2 Flutes	R0.25	2.5	0.4	45	4	470
CBN-LBF 2005-025			2.5	0.4	50	4	121
HSLB 2005-025-6			2.5	0.4	50	6	448
CSELB 2005-025-6			2.5	0.4	50	6	470
HSLB 2005-030S			3	0.4	35	4	465
HGLB 2005-030			3	0.4	45	4	437
HSLB 2005-030			3	0.4	45	4	448
CSELB 2005-030			3	0.4	45	4	470
DCLB 2005-030S			3	0.4	45	4	484
DLCLB 2005-030			3	0.4	45	4	488
HSLB 2005-030-6			3	0.4	50	6	448
CSELB 2005-030-6			3	0.4	50	6	470
HGLB 2005-035			3.5	0.4	45	4	437
HSLB 2005-035			3.5	0.4	45	4	448
CSELB 2005-035			3.5	0.4	45	4	470
CBN-LBF 2005-035			3.5	0.4	50	4	121
HGLB 2005-040			4	0.4	45	4	437
HSLB 2005-040			4	0.4	45	4	448
CSELB 2005-040			4	0.4	45	4	470
DLCLB 2005-040			4	0.4	45	4	488
HSLB 2005-040-6			4	0.4	50	6	448
CSELB 2005-040-6			4	0.4	50	6	470
CPRB 2005-4			4	0.8	45	4	498
HGLB 2005-045			4.5	0.4	45	4	437
HSLB 2005-045			4.5	0.4	45	4	448
CSELB 2005-045			4.5	0.4	45	4	470
HGLB 2005-050			5	0.4	45	4	437
HSLB 2005-050			5	0.4	45	4	448
CSELB 2005-050			5	0.4	45	4	470
DLCLB 2005-050			5	0.4	45	4	488
HSLB 2005-055			5.5	0.4	45	4	448
CSELB 2005-055			5.5	0.4	45	4	470
HGLB 2005-060			6	0.4	45	4	437
HSLB 2005-060			6	0.4	45	4	448
CSELB 2005-060			6	0.4	45	4	470
DCLB 2005-060			6	0.4	45	4	484
CPRB 2005-6			6	0.8	45	4	498
HSLB 2005-070			7	0.4	45	4	448
CSELB 2005-070			7	0.4	45	4	470
HSLB 2005-080			8	0.4	45	4	448
CSELB 2005-080	2 Flutes	R0.25	8	0.4	45	4	470
CBP 2005-8			8	0.8	45	4	498
HSLB 2005-090			9	0.4	45	4	448
CSELB 2005-090			9	0.4	45	4	470
DCLB 2005-0100			10	0.4	45	4	484
HSLB 2005-100			10	0.4	50	4	448
CSELB 2005-100			10	0.4	50	4	470
CPRB 2005-10			10	0.8	50	4	498
UDCBF 2006-0042			—	0.42	50	4	80
UDCB 2006-0042			—	0.42	50	4	94
HSB 2006-0060S	—	0.6	35	4	403		
HGB 2006-0060	—	0.6	50	4	396		
HSB 2006-0060	—	0.6	50	4	399		
CSEB 2006-0060	—	0.6	50	4	406		
HSB 2006-0060-6	—	0.6	50	6	399		
CSEB 2006-0060-6	—	0.6	50	6	406		
HGB 2006-0090	—	0.9	50	4	396		
HSB 2006-0090	—	0.9	50	4	399		
CSEB 2006-0090	—	0.9	50	4	406		
CGB 2006	—	1.2	60	4	414		
CFB 3006-0090	3 Flutes	R0.3	—	0.9	50	4	416
DLC-CFB 3006-0090			—	0.9	50	4	422
UPDLB 1006-010	1 Flutes	R0.3	1	0.3	40	4	434
UDCLBF 2006-0100	2 Flutes		1	0.42	50	4	83
UDCLB 2006-0100			1	0.42	50	4	98
HSLB 2006-010S			1	0.48	35	4	465
HGLB 2006-010			1	0.48	45	4	438
HSLB 2006-010			1	0.48	45	4	448
CSELB 2006-010			1	0.48	45	4	470
DLCLB 2006-010			1	0.48	45	4	490
CBN-LBSF 2006-010			1	0.48	50	4	115
CBN-LBF 2006-010			1	0.48	50	4	121
HSLB 2006-0125		1.25	0.48	45	4	448	
CSELB 2006-0125	1.25	0.48	45	4	470		
UDCLBF 2006-0150	1.5	0.42	50	4	83		
UDCLB 2006-0150	1.5	0.42	50	4	98		
HSLB 2006-015S	1.5	0.48	35	4	465		
HGLB 2006-015	1.5	0.48	45	4	438		
HSLB 2006-015	1.5	0.48	45	4	448		
CSELB 2006-015	1.5	0.48	45	4	470		

Simplified Table

Ball

Model Number	Number of Flutes	Radius of Ball Nose	Effective Length	Length of Cut	Overall Length	Shank Diameter	Page	Model Number	Number of Flutes	Radius of Ball Nose	Effective Length	Length of Cut	Overall Length	Shank Diameter	Page	
CBN-LBSF 2006-015	2 Flutes	R0.3	1.5	0.48	50	4	115	HSLB 2006-030-6	2 Flutes	R0.3	3	0.48	50	6	448	
CBN-LBF 2006-015			1.5	0.48	50	4	121	CSELB 2006-030-6			3	0.48	50	6	470	
HGLB 2006-015-6			1.5	0.48	50	6	438	HGLB 2006-035			3.5	0.48	45	4	438	
HSLB 2006-015-6			1.5	0.48	50	6	448	HSLB 2006-035			3.5	0.48	45	4	448	
CSELB 2006-015-6			1.5	0.48	50	6	470	CSELB 2006-035			3.5	0.48	45	4	470	
HSLB 2006-0175			1.75	0.48	45	4	448	UDCLBF 2006-0400			4	0.42	50	4	83	
CSELB 2006-0175			1.75	0.48	45	4	470	HSLB 2006-040S			4	0.48	40	4	465	
UDCLBF 2006-0200			2	0.42	50	4	83	HGLB 2006-040			4	0.48	45	4	438	
UDCLB 2006-0200			2	0.42	50	4	98	HSLB 2006-040			4	0.48	45	4	448	
HSLB 2006-020S			2	0.48	35	4	465	CSELB 2006-040			4	0.48	45	4	470	
HGLB 2006-020			2	0.48	45	4	438	DCLB 2006-0040			4	0.48	45	4	484	
HSLB 2006-020			2	0.48	45	4	448	DLCLB 2006-040			4	0.48	45	4	490	
CSELB 2006-020			2	0.48	45	4	470	CBN-LBF 2006-040			4	0.48	50	4	121	
DCLB 2006-0020			2	0.48	45	4	484	HSLB 2006-040-6			4	0.48	50	6	448	
DLCLB 2006-020			2	0.48	45	4	490	CSELB 2006-040-6			4	0.48	50	6	470	
CFLB 3006-020			2	0.48	50	4	502	CPRB 2006-4			4	1	45	4	498	
CBN-LBSF 2006-020			2	0.48	50	4	115	CFLB 3006-040			3 Flutes	4	0.48	50	4	502
HGLB 2006-020-6			2	0.48	50	6	438	HGLB 2006-045			2 Flutes	4.5	0.48	45	4	438
HSLB 2006-020-6			2	0.48	50	6	448	HSLB 2006-045				4.5	0.48	45	4	448
CSELB 2006-020-6			2	0.48	50	6	470	CSELB 2006-045				4.5	0.48	45	4	470
CPRB 2006-2			2	1	45	4	498	UDCLBF 2006-0500	5	0.42		50	4	83		
HSLB 2006-0225			2.25	0.48	45	4	448	HSLB 2006-050S	5	0.48		40	4	465		
CSELB 2006-0225			2.25	0.48	45	4	470	HGLB 2006-050	5	0.48		45	4	438		
HGLB 2006-025			2.5	0.48	45	4	438	HSLB 2006-050	5	0.48		45	4	448		
HSLB 2006-025			2.5	0.48	45	4	448	CSELB 2006-050	5	0.48		45	4	470		
CSELB 2006-025			2.5	0.48	45	4	470	DLCLB 2006-050	5	0.48		45	4	490		
HGLB 2006-025-6			2.5	0.48	50	6	438	CBN-LBF 2006-050	5	0.48		50	4	121		
HSLB 2006-025-6			2.5	0.48	50	6	448	HSLB 2006-050-6	5	0.48		50	6	448		
CSELB 2006-025-6			2.5	0.48	50	6	470	CSELB 2006-050-6	5	0.48		50	6	470		
UDCLBF 2006-0300			3	0.42	50	4	83	HGLB 2006-055	5.5	0.48		45	4	438		
UDCLB 2006-0300			3	0.42	50	4	98	HSLB 2006-055	5.5	0.48		45	4	448		
HSLB 2006-030S			3	0.48	35	4	465	CSELB 2006-055	5.5	0.48		45	4	470		
HGLB 2006-030			3	0.48	45	4	438	UDCLBF 2006-0600	6	0.42		50	4	83		
HSLB 2006-030			3	0.48	45	4	448	HSLB 2006-060S	6	0.48		40	4	465		
CSELB 2006-030			3	0.48	45	4	470	HGLB 2006-060	6	0.48		45	4	438		
DCLB 2006-0030			3	0.48	45	4	484	HSLB 2006-060	6	0.48		45	4	448		
DLCLB 2006-030			3	0.48	45	4	490	CSELB 2006-060	6	0.48		45	4	470		
CFLB 3006-030			3	0.48	50	4	502	DCLB 2006-0060	6	0.48	45	4	484			
CBN-LBF 2006-030			3	0.48	50	4	121	DLCLB 2006-060	6	0.48	45	4	490			
HGLB 2006-030-6			3	0.48	50	6	438	CBN-LBF 2006-060	6	0.48	50	4	121			

Simplified Table

Ball

Model Number	Number of Flutes	Radius of Ball Nose	Effective Length	Length of Cut	Overall Length	Shank Diameter	Page	Model Number	Number of Flutes	Radius of Ball Nose	Effective Length	Length of Cut	Overall Length	Shank Diameter	Page	
HSLB 2006-060-6	2 Flutes	R0.3	6	0.48	50	6	448	HSB 2008-0080S	2 Flutes	R0.4	—	0.8	35	4	403	
CSELB 2006-060-6			6	0.48	50	6	470	HSB 2008-0080			—	0.8	50	4	399	
CPRB 2006-6			6	1	45	4	498	CSEB 2008-0080			—	0.8	50	4	406	
CFLB 3006-060	3 Flutes		6	0.48	50	4	502	HSB 2008-0080-6			3 Flutes	—	0.8	50	6	399
HSLB 2006-065			6.5	0.48	45	4	448	CSEB 2008-0080-6				—	0.8	50	6	406
CSELB 2006-065			6.5	0.48	45	4	470	HGB 2008-0120				—	1.2	50	4	396
HSLB 2006-070	2 Flutes		7	0.48	45	4	448	HSB 2008-0120			2 Flutes	—	1.2	50	4	399
CSELB 2006-070			7	0.48	45	4	470	CSEB 2008-0120				—	1.2	50	4	406
HGLB 2006-080			8	0.48	45	4	438	CFB 3008-0120				—	1.2	50	4	416
HSLB 2006-080			8	0.48	45	4	448	DLC-CFB 3008-0120				—	1.2	50	4	422
CSELB 2006-080			8	0.48	45	4	470	UDCLBF 2008-0200				2	0.56	50	4	83
HSLB 2006-080-6			8	0.48	50	6	448	UDCLB 2008-0200				2	0.56	50	4	98
CSELB 2006-080-6		8	0.48	50	6	470	CBN-LBSF 2008-020	2	0.6	50		4	115			
CPRB 2006-8		8	1	45	4	498	CBN-LBF 2008-020	2	0.6	50		4	121			
HSLB 2006-090		9	0.48	45	4	448	HSLB 2008-020S	2	0.64	35		4	465			
CSELB 2006-090		9	0.48	45	4	470	HGLB 2008-020	2	0.64	45		4	438			
HGLB 2006-100		10	0.48	45	4	438	HSLB 2008-020	2	0.64	45		4	449			
DCLB 2006-0100		10	0.48	45	4	484	CSELB 2008-020	2	0.64	45		4	471			
HSLB 2006-100	10	0.48	50	4	448	DLCB 2008-020	2	0.64	45	4	490					
CSELB 2006-100	10	0.48	50	4	470	HSB 2008-020-6	2	0.64	50	6	449					
HSLB 2006-100-6	10	0.48	50	6	448	CSELB 2008-020-6	2	0.64	50	6	471					
CSELB 2006-100-6	10	0.48	50	6	470	CPRB 2008-2	2	1.1	45	4	498					
DCLB 2006-0120	12	0.48	45	4	484	HGLB 2008-025	2.5	0.64	45	4	438					
HSLB 2006-120	12	0.48	50	4	448	UDCLBF 2008-0300	3	0.56	50	4	83					
CSELB 2006-120	12	0.48	50	4	470	UDCLB 2008-0300	3	0.56	50	4	98					
UDCBF 2007-0049	2 Flutes	R0.35	—	0.49	50	4	80	HSB 2008-030S	2 Flutes	3	0.64	35	4	465		
UDCB 2007-0049			—	0.49	50	4	94	HGLB 2008-030		3	0.64	45	4	438		
HSB 2007-0100			—	1	50	4	399	HSB 2008-030		3	0.64	45	4	449		
CSEB 2007-0100			—	1	50	4	406	CSELB 2008-030		3	0.64	45	4	471		
HSLB 2007-020			2	0.56	45	4	449	DLCB 2008-030		3	0.64	45	4	490		
CSELB 2007-020			2	0.56	45	4	471	HSB 2008-030-6		3	0.64	50	6	449		
HSLB 2007-040			4	0.56	45	4	449	CSELB 2008-030-6		3	0.64	50	6	471		
CSELB 2007-040			4	0.56	45	4	471	UDCLBF 2008-0400		4	0.56	50	4	83		
HSLB 2007-060			6	0.56	45	4	449	UDCLB 2008-0400		4	0.56	50	4	98		
CSELB 2007-060			6	0.56	45	4	471	CBN-LBSF 2008-040		4	0.6	50	4	115		
HSLB 2007-080			8	0.56	45	4	449	CBN-LBF 2008-040		4	0.6	50	4	121		
CSELB 2007-080			8	0.56	45	4	471	HSB 2008-040S		4	0.64	35	4	465		
UDCBH 2008-0056	2 Flutes	R0.4	—	0.56	50	4	78	HGLB 2008-040	4	0.64	45	4	438			
UDCBF 2008-0056			—	0.56	50	4	80	HSB 2008-040	4	0.64	45	4	449			
UDCB 2008-0056			—	0.56	50	4	94	CSELB 2008-040	4	0.64	45	4	471			

Simplified Table

Ball

Model Number	Number of Flutes	Radius of Ball Nose	Effective Length	Length of Cut	Overall Length	Shank Diameter	Page	Model Number	Number of Flutes	Radius of Ball Nose	Effective Length	Length of Cut	Overall Length	Shank Diameter	Page
DLCLB 2008-040	2 Flutes	R0.4	4	0.64	45	4	490	CSELB 2008-120	2 Flutes	R0.4	12	0.64	45	4	471
HSLB 2008-040-6			4	0.64	50	6	449	HSLB 2008-120			12	0.64	50	4	449
CSELB 2008-040-6			4	0.64	50	6	471	DCLB 2008-0120			12	0.64	50	4	484
CPRB 2008-4			4	1.1	45	4	498	HSLB 2008-160			16	0.64	50	4	449
CFLB 3008-040	3 Flutes		4	0.64	50	4	502	CSELB 2008-160	16		0.64	50	4	471	
UDCLBF 2008-0300	2 Flutes		5	0.56	50	4	83	DCLB 2008-0160	16		0.64	50	4	484	
HGLB 2008-030			5	0.64	45	4	438	UDCBF 2009-0063	—		0.63	50	4	80	
HSLB 2008-050			5	0.64	45	4	449	UDCB 2009-0063	—		0.63	50	4	94	
CSELB 2008-050			5	0.64	45	4	471	HSB 2009-0130	—		1.3	50	4	399	
UDCLBF 2008-0600			6	0.56	50	4	83	CSEB 2009-0130	—		1.3	50	4	407	
CBN-LBF 2008-060		6	0.6	50	4	121	HSLB 2009-020	2	0.72	45	4	449			
HSLB 2008-060S		6	0.64	40	4	465	CSELB 2009-020	2	0.72	45	4	471			
HGLB 2008-060		6	0.64	45	4	438	HSLB 2009-040	4	0.72	45	4	449			
HSLB 2008-060		6	0.64	45	4	449	CSELB 2009-040	4	0.72	45	4	471			
CSELB 2008-060		6	0.64	45	4	471	HSLB 2009-060	6	0.72	45	4	449			
DLCLB 2008-060	6	0.64	45	4	490	CSELB 2009-060	6	0.72	45	4	471				
HSLB 2008-060-6	6	0.64	50	6	449	HSLB 2009-080	8	0.72	45	4	449				
CSELB 2008-060-6	6	0.64	50	6	471	CSELB 2009-080	8	0.72	45	4	471				
CPRB 2008-6	6	1.1	45	4	498	HSLB 2009-100	10	0.72	45	4	449				
CFLB 3008-060	3 Flutes	6	0.64	50	4	502	CSELB 2009-100	10	0.72	45	4	471			
HGLB 2008-070	2 Flutes	7	0.64	45	4	438	CSELB 2009-120	12	0.72	45	4	471			
HSLB 2008-070		7	0.64	45	4	449	HSLB 2009-120	12	0.72	50	4	449			
CSELB 2008-070		7	0.64	45	4	471	HSLB 2009-140	14	0.72	50	4	449			
UDCLBF 2008-0800		8	0.56	50	4	83	CSELB 2009-140	14	0.72	50	4	471			
HGLB 2008-080		8	0.64	45	4	438	HSLB 2009-160	16	0.72	50	4	449			
HSLB 2008-080		8	0.64	45	4	449	CSELB 2009-160	16	0.72	50	4	471			
CSELB 2008-080		8	0.64	45	4	471	HSLB 2009-180	18	0.72	55	4	449			
DLCLB 2008-080		8	0.64	45	4	490	CSELB 2009-180	18	0.72	55	4	471			
HSLB 2008-080-6		8	0.64	50	6	449	UDCBH 2010-0070	—	0.7	50	4	78			
CSELB 2008-080-6		8	0.64	50	6	471	UDCBF 2010-0070	—	0.7	50	4	80			
CPRB 2008-8	8	1.1	45	4	498	UDCB 2010-0070	—	0.7	50	4	94				
CFLB 3008-080	3 Flutes	8	0.64	50	4	502	HSB 2010-0100S	—	1	35	4	403			
HSLB 2008-090	2 Flutes	9	0.64	45	4	449	HSB 2010-0100	—	1	50	4	399			
CSELB 2008-090		9	0.64	45	4	471	CSEB 2010-0100	—	1	50	4	407			
DCLB 2008-0100		10	0.64	45	4	484	HSB 2010-0100-6	—	1	50	6	399			
HSLB 2008-100		10	0.64	50	4	449	CSEB 2010-0100-6	—	1	50	6	407			
CSELB 2008-100		10	0.64	50	4	471	HGB 2010-0150	—	1.5	50	4	396			
HSLB 2008-100-6		10	0.64	50	6	449	HSB 2010-0150	—	1.5	50	4	399			
CSELB 2008-100-6		10	0.64	50	6	471	CSEB 2010-0150	—	1.5	50	4	407			
CPRB 2008-10		10	1.1	50	4	498	HSB 2010-0250	—	2.5	50	4	399			

Simplified Table

Ball																
Model Number	Number of Flutes	Radius of Ball Nose	Effective Length	Length of Cut	Overall Length	Shank Diameter	Page	Model Number	Number of Flutes	Radius of Ball Nose	Effective Length	Length of Cut	Overall Length	Shank Diameter	Page	
CSEB	2010-0250	2 Flutes	R0.5	—	2.5	50	4 407	CPRB	2010-3	2 Flutes	3	1.2	45	4	499	
DCB	2010			—	5	60	4 412	CFLB	3010-030	3 Flutes	3	0.8	50	4	502	
CGB	2010	3 Flutes	R0.5	—	5	60	4 414	UDCLBF	2010-0400	2 Flutes	4	0.7	50	4	83	
CFB	3010-0150			—	1.5	50	4 416	UDCLB	2010-0400		4	0.7	50	4	98	
DLC-CFB	3010-0150			—	1.5	50	4 422	CBN-LBSF	2010-040		4	0.7	50	4	115	
UDCLBF	2010-0150	1.5	0.7	50	4 83	CBN-LBF	2010-040	4	0.7		50	4	121			
CBN-LBSF	2010-015	1.5	0.7	50	4 115	HSLB	2010-040S	4	0.8		35	4	466			
CBN-LBF	2010-015	1.5	0.7	50	4 121	HGLB	2010-040	4	0.8		45	4	438			
UPDLB	1010-020	1 Flutes	R0.5	2	0.5	40	4 434	HSLB	2010-040		2 Flutes	4	0.8	45	4	450
UDCLBF	2010-0200	2		0.7	50	4 83	CSELB	2010-040	4		0.8	45	4	472		
UDCLB	2010-0200	2		0.7	50	4 98	DLCB	2010-040	4		0.8	45	4	490		
CBN-LBSF	2010-020	2		0.7	50	4 115	HGLB	2010-040-6	4		0.8	50	6	438		
CBN-LBF	2010-020	2		0.7	50	4 121	HSLB	2010-040-6	4	0.8	50	6	450			
HSLB	2010-020S	2		0.8	35	4 466	CSELB	2010-040-6	4	0.8	50	6	472			
HGLB	2010-020	2		0.8	45	4 438	CPRB	2010-4	4	1.2	45	4	499			
HSLB	2010-020	2		0.8	45	4 450	CFLB	3010-040	3 Flutes	4	0.8	50	4	502		
CSELB	2010-020	2		0.8	45	4 472	UDCLB	2010-0500	2 Flutes	5	0.7	50	4	98		
DLCB	2010-020	2		0.8	45	4 490	CBN-LBF	2010-050		5	0.7	50	4	121		
HGLB	2010-020-6	2		0.8	50	6 438	HGLB	2010-050		5	0.8	45	4	438		
UDCLBF	2010-0250	2.5		0.7	50	4 83	HSLB	2010-050		5	0.8	45	4	450		
UDCLB	2010-0250	2.5		0.7	50	4 98	CSELB	2010-050		5	0.8	45	4	472		
CBN-LBSF	2010-025	2.5		0.7	50	4 115	DCLB	2010-0050		5	0.8	45	4	485		
CBN-LBF	2010-025	2.5		0.7	50	4 121	DLCB	2010-050		5	0.8	45	4	490		
HSLB	2010-025S	2.5		0.8	35	4 466	HGLB	2010-050-6		5	0.8	50	6	438		
HGLB	2010-025	2.5		0.8	45	4 438	HSLB	2010-050-6		5	0.8	50	6	450		
HSLB	2010-025	2.5		0.8	45	4 450	CSELB	2010-050-6		5	0.8	50	6	472		
CSELB	2010-025	2.5		0.8	45	4 472	CFLB	3010-050	3 Flutes	5	0.8	50	4	502		
CFLB	3010-025	3 Flutes		R0.5	2.5	0.8	50	4 502	UDCLBF	2010-0600	2 Flutes	6	0.7	50	4	83
UDCLBF	2010-0300	3	0.7		50	4 83	CBN-LBSF	2010-060	6	0.7		50	4	115		
UDCLB	2010-0300	3	0.7		50	4 98	CBN-LBF	2010-060	6	0.7		50	4	121		
CBN-LBSF	2010-030	3	0.7		50	4 115	HSLB	2010-060S	6	0.8		40	4	466		
HSLB	2010-030S	3	0.8		35	4 466	HGLB	2010-060	6	0.8		45	4	438		
HGLB	2010-030	3	0.8		45	4 438	HSLB	2010-060	6	0.8		45	4	450		
HSLB	2010-030	3	0.8		45	4 450	CSELB	2010-060	6	0.8		45	4	472		
CSELB	2010-030	3	0.8		45	4 472	DCLB	2010-0060	6	0.8		45	4	485		
DCLB	2010-0030	3	0.8		45	4 485	DLCB	2010-060	6	0.8		45	4	490		
DLCB	2010-030	3	0.8		45	4 490	HGLB	2010-060-6	6	0.8		50	6	438		
HGLB	2010-030-6	3	0.8		50	6 438	HSLB	2010-060-6	6	0.8	50	6	450			
HSLB	2010-030-6	3	0.8		50	6 450	CSELB	2010-060-6	6	0.8	50	6	472			
CSELB	2010-030-6	3	0.8		50	6 472	CPRB	2010-6	6	1.2	45	4	499			

Simplified Table

Ball

Model Number	Number of Flutes	Radius of Ball Nose	Effective Length	Length of Cut	Overall Length	Shank Diameter	Page	Model Number	Number of Flutes	Radius of Ball Nose	Effective Length	Length of Cut	Overall Length	Shank Diameter	Page
CFLB	3010-060	3 Flutes	R0.5	6	0.8	50	4 502	HSLB	2010-120-6	2 Flutes	12	0.8	50	6 450	
HGLB	2010-070	2 Flutes		7	0.8	45	4 438	CSELB	2010-120-6		12	0.8	50	6 472	
HSLB	2010-070			7	0.8	45	4 450	CPRB	2010-12	12	1.2	45	4 499		
CSELB	2010-070			7	0.8	45	4 472	CFLB	3010-120	3 Flutes	12	0.8	50	4 502	
HGLB	2010-070-6			7	0.8	50	6 438	HGLB	2010-140	R0.5	14	0.8	45	4 438	
HSLB	2010-070-6			7	0.8	50	6 450	HSLB	2010-140		14	0.8	50	4 450	
CSELB	2010-070-6			7	0.8	50	6 472	CSELB	2010-140		14	0.8	50	4 472	
UDCLBF	2010-0800			8	0.7	50	4 83	HSLB	2010-140-6		14	0.8	60	6 450	
CBN-LBF	2010-080			8	0.7	50	4 121	CSELB	2010-140-6		14	0.8	60	6 472	
HSLB	2010-080S			8	0.8	40	4 466	CPRB	2010-14		14	1.2	50	4 499	
HGLB	2010-080			8	0.8	45	4 438	HGLB	2010-160		16	0.8	50	4 438	
HSLB	2010-080			8	0.8	45	4 450	HSLB	2010-160		16	0.8	50	4 450	
CSELB	2010-080			8	0.8	45	4 472	CSELB	2010-160		16	0.8	50	4 472	
DCLB	2010-0800			8	0.8	45	4 485	DCLB	2010-0160		16	0.8	50	4 485	
DLCLB	2010-080			8	0.8	45	4 490	HSLB	2010-160-6		16	0.8	60	6 450	
HGLB	2010-080-6			8	0.8	50	6 438	CSELB	2010-160-6		16	0.8	60	6 472	
HSLB	2010-080-6			8	0.8	50	6 450	CPRB	2010-16		16	1.2	50	4 499	
CSELB	2010-080-6			8	0.8	50	6 472	HSLB	2010-180		18	0.8	55	4 450	
CPRB	2010-8			8	1.2	45	4 499	CSELB	2010-180		18	0.8	55	4 472	
CFLB	3010-080	3 Flutes		8	0.8	50	4 502	HSLB	2010-200		20	0.8	55	4 450	
HSLB	2010-090	2 Flutes	9	0.8	45	4 450	CSELB	2010-200	20		0.8	55	4 472		
CSELB	2010-090		9	0.8	45	4 472	HSLB	2010-200-6	20		0.8	70	6 450		
UDCLBF	2010-1000		10	0.7	50	4 83	CSELB	2010-200-6	20	0.8	70	6 472			
CBN-LBF	2010-100		10	0.7	50	4 121	CPRB	2010-20	20	1.2	55	4 499			
HGLB	2010-100		10	0.8	45	4 438	DCLB	2010-0200	20	1.5	60	4 485			
HSLB	2010-100		10	0.8	45	4 450	HSLB	2010-220-6	22	0.8	70	6 450			
CSELB	2010-100		10	0.8	45	4 472	CSELB	2010-220-6	22	0.8	70	6 472			
DCLB	2010-0100-08		10	0.8	45	4 485	HSB	2011-0160	2 Flutes	R0.55	—	1.6	50	4 399	
DLCLB	2010-100		10	0.8	45	4 490	CSEB	2011-0160	—	1.6	50	4 407			
HGLB	2010-100-6		10	0.8	50	6 438	UDCBF	2012-0084	—	0.84	50	4 80			
HSLB	2010-100-6		10	0.8	50	6 450	HSB	2012-0180	—	1.8	50	4 399			
CSELB	2010-100-6		10	0.8	50	6 472	CSEB	2012-0180	—	1.8	50	4 407			
CPRB	2010-10		10	1.2	45	4 499	CBN-LBF	2012-024	2.4	0.8	50	4 121			
DCLB	2010-0100		10	1.5	60	4 485	HSLB	2012-025	2.5	0.96	45	4 450			
CFLB	3010-100		3 Flutes	10	0.8	50	4 502	CSELB	2012-025	2.5	0.96	45	4 472		
HGLB	2010-120		2 Flutes	12	0.8	45	4 438	CBN-LBF	2012-030	3	0.8	50	4 121		
HSLB	2010-120			12	0.8	45	4 450	HSLB	2012-040	4	0.96	45	4 450		
CSELB	2010-120			12	0.8	45	4 472	CSELB	2012-040	4	0.96	45	4 472		
DLCLB	2010-120	12		0.8	45	4 490	CBN-LBF	2012-060	6	0.8	50	4 121			
DCLB	2010-0120	12		0.8	50	4 485	HSLB	2012-060	6	0.96	45	4 450			

Simplified Table

Ball																
Ball								Ball								
Model Number	Number of Flutes	Radius of Ball Nose	Effective Length	Length of Cut	Overall Length	Shank Diameter	Page	Model Number	Number of Flutes	Radius of Ball Nose	Effective Length	Length of Cut	Overall Length	Shank Diameter	Page	
CSELB 2012-060			6	0.96	45	4	472	CSELB 2014-160 CPRB 2014-16 UDCBH 2015-0105 UDCBF 2015-0105 HSB 2015-0150S HSB 2015-0150 CSEB 2015-0150 HSB 2015-0150-6 CSEB 2015-0150-6 HSB 2015-0200 CSEB 2015-0200 HGB 2015-0225 HSB 2015-0225 CSEB 2015-0225 HSB 2015-0400 CSEB 2015-0400 CGB 2015 CFB 3015-0225 DLC-CFB 3015-0225 UDCLBF 2015-0200 CBN-LBSF 2015-025 CBN-LBSF 2015-030 CBN-LBF 2015-030 HSLB 2015-030S HGLB 2015-030 HSLB 2015-030 CSELB 2015-030 HGLB 2015-030-6 CBN-LBSF 2015-038 CBN-LBF 2015-040 UDCLBF 2015-0400 HSLB 2015-040S HGLB 2015-040 HSLB 2015-040 CSELB 2015-040 DLCLB 2015-040 CFLB 3015-040 CBN-LBSF 2015-060 CBN-LBF 2015-060 UDCLBF 2015-0600	2 Flutes	R0.7	16	1.12	50	4	473	
HSLB 2012-060-6			6	0.96	50	6	450				16	1.4	50	4	499	
CSELB 2012-060-6			6	0.96	50	6	472				—	1.05	50	4	78	
HSLB 2012-080			8	0.96	45	4	450				—	1.05	50	4	80	
CSELB 2012-080			8	0.96	45	4	472				—	1.5	35	4	403	
HSLB 2012-080-6			8	0.96	50	6	450				—	1.5	50	4	399	
CSELB 2012-080-6			8	0.96	50	6	472				—	1.5	50	4	407	
CPRB 2012-8			8	1.3	45	4	499				—	1.5	50	6	399	
HSLB 2012-100			10	0.96	45	4	450				—	1.5	50	6	407	
CSELB 2012-100			10	0.96	45	4	472				—	2	50	4	399	
HSLB 2012-100-6			10	0.96	50	6	450				—	2	50	4	407	
CSELB 2012-100-6			10	0.96	50	6	472				—	2.25	50	4	396	
HSLB 2012-120			12	0.96	45	4	450				—	2.25	50	4	399	
CSELB 2012-120	2 Flutes	R0.6	12	0.96	45	4	472				—	2.25	50	4	407	
HSLB 2012-120-6			12	0.96	50	6	450				—	4	50	4	399	
CSELB 2012-120-6			12	0.96	50	6	472				—	4	50	4	407	
CPRB 2012-12			12	1.3	45	4	499				—	5	60	4	414	
HSLB 2012-140			14	0.96	50	4	450				—	2.25	50	4	416	
CSELB 2012-140			14	0.96	50	4	472				—	2.25	50	4	422	
HSLB 2012-160			16	0.96	50	4	450				2	1.05	50	4	83	
CSELB 2012-160			16	0.96	50	4	472				2.5	0.9	50	4	115	
HSLB 2012-160-6			16	0.96	60	6	450				3	0.9	50	4	115	
CSELB 2012-160-6			16	0.96	60	6	472				3	0.9	50	4	121	
HSLB 2012-180			18	0.96	55	4	450				3	1.2	35	4	466	
CSELB 2012-180			18	0.96	55	4	472				3	1.2	45	4	439	
HSLB 2012-200			20	0.96	60	4	450				3	1.2	45	4	451	
CSELB 2012-200			20	0.96	60	4	472				3	1.2	45	4	473	
HSB 2013-0190	2 Flutes	R0.65	—	1.9	50	4	399				3	1.2	50	6	439	
CSEB 2013-0190			—	1.9	50	4	407				3.8	0.9	50	4	115	
HSB 2014-0210			—	2.1	50	4	399				4	0.9	50	4	121	
CSEB 2014-0210			—	2.1	50	4	407				4	1.05	50	4	83	
HSLB 2014-060			6	1.12	45	4	450				4	1.2	35	4	466	
CSELB 2014-060			6	1.12	45	4	473				4	1.2	45	4	439	
HSLB 2014-080			8	1.12	45	4	450	4	1.2	45	4	451				
CSELB 2014-080	2 Flutes	R0.7	8	1.12	45	4	473	4	1.2	45	4	473				
CPRB 2014-8			8	1.4	45	4	499	4	1.2	45	4	490				
HSLB 2014-120			12	1.12	45	4	450	4	1.2	50	4	503				
CSELB 2014-120			12	1.12	45	4	473	6	0.9	50	4	115				
CPRB 2014-12			12	1.4	45	4	499	6	0.9	50	4	121				
HSLB 2014-160			16	1.12	50	4	450	6	1.05	50	4	83				

Simplified Table

Ball

Model Number	Number of Flutes	Radius of Ball Nose	Effective Length	Length of Cut	Overall Length	Shank Diameter	Page	Model Number	Number of Flutes	Radius of Ball Nose	Effective Length	Length of Cut	Overall Length	Shank Diameter	Page	
HSLB 2015-060S	2 Flutes	R0.75	6	1.2	40	4	466	DLCLB 2015-120	2 Flutes	R0.75	12	1.2	50	4	490	
HGLB 2015-060			6	1.2	45	4	439	HGLB 2015-120-6			12	1.2	50	6	439	
HSLB 2015-060			6	1.2	45	4	451	HSLB 2015-120-6			12	1.2	50	6	451	
CSELB 2015-060			6	1.2	45	4	473	CSELB 2015-120-6			12	1.2	50	6	473	
DCLB 2015-060			6	1.2	45	4	485	CPRB 2015-12			12	1.45	45	4	499	
DLCLB 2015-060			6	1.2	45	4	490	CFLB 3015-120			3 Flutes	12	1.2	50	4	503
HGLB 2015-060-6			6	1.2	50	6	439	HGLB 2015-140	2 Flutes		14	1.2	45	4	439	
HSLB 2015-060-6			6	1.2	50	6	451	HSLB 2015-140			14	1.2	50	4	451	
CSELB 2015-060-6			6	1.2	50	6	473	CSELB 2015-140			14	1.2	50	4	473	
CPRB 2015-6			6	1.45	45	4	499	CBN-LBF 2015-150			15	0.9	50	4	121	
CFLB 3015-060			3 Flutes	6	1.2	50	4	503			HGLB 2015-160	16	1.2	50	4	439
CBN-LBSF 2015-080			2 Flutes	8	0.9	50	4	115			HSLB 2015-160	16	1.2	50	4	451
CBN-LBF 2015-080	8	0.9		50	4	121	CSELB 2015-160	16	1.2	50	4	473				
UDCLBF 2015-080	8	1.05		50	4	83	DCLB 2015-0160	16	1.2	50	4	485				
HSLB 2015-080S	8	1.2		40	4	466	HSLB 2015-160-6	16	1.2	60	6	451				
HGLB 2015-080	8	1.2		45	4	439	CSELB 2015-160-6	16	1.2	60	6	473				
HSLB 2015-080	8	1.2		45	4	451	CPRB 2015-16	16	1.45	50	4	499				
CSELB 2015-080	8	1.2		45	4	473	CFLB 3015-160	3 Flutes	16	1.2	50	4	503			
HGLB 2015-080-6	8	1.2		50	6	439	HSLB 2015-180	2 Flutes	18	1.2	55	4	451			
HSLB 2015-080-6	8	1.2		50	6	451	CSELB 2015-180		18	1.2	55	4	473			
CSELB 2015-080-6	8	1.2		50	6	473	DLCLB 2015-180		18	1.2	55	4	490			
CPRB 2015-8	8	1.45		45	4	499	HSLB 2015-200		20	1.2	55	4	451			
CFLB 3015-080	3 Flutes	8		1.2	50	4	503		CSELB 2015-200	20	1.2	55	4	473		
CBN-LBF 2015-100	2 Flutes	10	0.9	50	4	121	HGLB 2015-200		20	1.2	60	4	439			
UDCLBF 2015-1000		10	1.05	50	4	83	HSLB 2015-200-6	20	1.2	60	6	451				
HSLB 2015-100S		10	1.2	40	4	466	CSELB 2015-200-6	20	1.2	60	6	473				
HGLB 2015-100		10	1.2	45	4	439	CPRB 2015-20	20	1.45	55	4	499				
HSLB 2015-100		10	1.2	45	4	451	HSLB 2015-220	22	1.2	55	4	451				
CSELB 2015-100		10	1.2	45	4	473	CSELB 2015-220	22	1.2	55	4	473				
DCLB 2015-0100		10	1.2	45	4	485	HSLB 2015-250	25	1.2	65	4	451				
HGLB 2015-100-6		10	1.2	50	6	439	CSELB 2015-250	25	1.2	65	4	473				
HSLB 2015-100-6		10	1.2	50	6	451	HSLB 2015-300	30	1.2	70	4	451				
CSELB 2015-100-6		10	1.2	50	6	473	CSELB 2015-300	30	1.2	70	4	473				
CPRB 2015-10		10	1.45	45	4	499	HSB 2016-0240	2 Flutes	—	2.4	50	4	399			
CFLB 3015-100		3 Flutes	10	1.2	50	4	503		CSEB 2016-0240	—	2.4	50	4	407		
CBN-LBF 2015-120	2 Flutes	12	0.9	50	4	121	HSLB 2016-040		4	1.28	45	4	451			
UDCLBF 2015-1200		12	1.05	50	4	83	CSELB 2016-040		4	1.28	45	4	473			
HGLB 2015-120		12	1.2	45	4	439	HSLB 2016-080		8	1.28	45	4	451			
HSLB 2015-120		12	1.2	45	4	451	CSELB 2016-080		8	1.28	45	4	473			
CSELB 2015-120		12	1.2	45	4	473	CPRB 2016-8	8	1.5	45	4	499				

Simplified Table

Ball									
Model Number	Number of Flutes	Radius of Ball Nose	Effective Length	Length of Cut	Overall Length	Shank Diameter	Page		
HSLB 2016-120	2 Flutes	R0.8	12	1.28	45	4	451		
CSELB 2016-120			12	1.28	45	4	473		
CPRB 2016-12			12	1.5	45	4	499		
HSLB 2016-160			16	1.28	50	4	451		
CSELB 2016-160			16	1.28	50	4	473		
CPRB 2016-16			16	1.5	50	4	499		
HSLB 2016-200			20	1.28	55	4	451		
CSELB 2016-200			20	1.28	55	4	473		
CPRB 2016-20			20	1.5	55	4	499		
HSB 2017-0250			2 Flutes	R0.85	—	2.5	50	4	399
CSEB 2017-0250	—	2.5			50	4	407		
HSB 2018-0270	2 Flutes	R0.9	—	2.7	50	4	399		
CSEB 2018-0270			—	2.7	50	4	407		
HSLB 2018-040			4	1.44	45	4	451		
CSELB 2018-040			4	1.44	45	4	473		
HSLB 2018-060			6	1.44	45	4	451		
CSELB 2018-060			6	1.44	45	4	473		
HSLB 2018-080			8	1.44	45	4	451		
CSELB 2018-080			8	1.44	45	4	473		
CPRB 2018-8			8	1.6	45	4	499		
HSLB 2018-100			10	1.44	45	4	451		
CSELB 2018-100	10	1.44	45	4	473				
HSLB 2018-120	2 Flutes	R0.9	12	1.44	45	4	451		
CSELB 2018-120			12	1.44	45	4	473		
CPRB 2018-12			12	1.6	45	4	499		
HSLB 2018-160			16	1.44	50	4	451		
CSELB 2018-160			16	1.44	50	4	473		
CPRB 2018-16			16	1.6	50	4	499		
HSLB 2018-180			18	1.44	55	4	451		
CSELB 2018-180			18	1.44	55	4	473		
HSLB 2018-200			20	1.44	55	4	451		
CSELB 2018-200			20	1.44	55	4	473		
CPRB 2018-20	20	1.6	55	4	499				
HSLB 2018-220	2 Flutes	R0.95	22	1.44	60	4	451		
CSELB 2018-220			22	1.44	60	4	473		
HSLB 2018-250			25	1.44	65	4	451		
CSELB 2018-250			25	1.44	65	4	473		
HSLB 2018-300			30	1.44	70	4	451		
CSELB 2018-300			30	1.44	70	4	473		
HSB 2019-0280			2 Flutes	R0.95	—	2.8	50	4	399

Model Number	Number of Flutes	Radius of Ball Nose	Effective Length	Length of Cut	Overall Length	Shank Diameter	Page	
CSEB 2019-0280	2 Flutes	R0.95	—	2.8	50	4	407	
UDCBH 2020-0140	2 Flutes	R1	—	1.4	50	4	78	
UDCBF 2020-0140			—	1.4	50	4	80	
UDCB 2020-0140			—	1.4	50	4	94	
HSB 2020-0200S			—	2	35	4	403	
HSB 2020-0200			—	2	50	4	399	
CSEB 2020-0200			—	2	50	4	407	
HSB 2020-0200-6			—	2	60	6	399	
CSEB 2020-0200-6			2 Flutes	—	2	60	6	407
HGB 2020-0300			—	3	50	4	396	
HSB 2020-0300			—	3	50	4	399	
CSEB 2020-0300	—	3	60	4	407			
HSB 2020-0600	—	6	60	4	399			
CSEB 2020-0600	—	6	60	4	407			
DCB 2020	—	10	70	4	412			
CGB 2020	—	10	70	4	414			
CFB 3020-0300	3 Flutes	—	3	50	4	416		
DLC-CFB 3020-0300		—	3	50	4	422		
HFB 4020-0300S	4 Flutes	—	3	40	4	427		
HFB 4020-0300		—	3	50	4	426		
HFB 4020-0300-6	—	3	50	6	426			
UPDLB 1020-030	1 Flutes	3	1	40	4	434		
CBN-LBSF 2020-030	2 Flutes	3	1.2	50	4	115		
UDCLBF 2020-0300		3	1.4	50	4	83		
UDCLB 2020-0300		3	1.4	50	4	98		
HSLB 2020-0300S		3	1.6	35	4	466		
HGLB 2020-030		3	1.6	45	4	439		
HSLB 2020-030		3	1.6	45	4	452		
CSELB 2020-030		3	1.6	45	4	474		
HGLB 2020-030-6		3	1.6	50	6	439		
CBN-LBSF 2020-040		4	1.2	50	4	115		
CBN-LBF 2020-040		4	1.2	50	4	121		
UDCLBF 2020-0400	4	1.4	50	4	83			
UDCLB 2020-0400	4	1.4	50	4	98			
HSLB 2020-0400S	4	1.6	35	4	466			
HGLB 2020-040	4	1.6	45	4	439			
HSLB 2020-040	4	1.6	45	4	452			
CSELB 2020-040	4	1.6	45	4	474			
DCLB 2020-0040	4	1.6	45	4	485			
DLCLB 2020-040	4	1.6	45	4	490			

Simplified Table

Ball

Model Number		Number of Flutes	Radius of Ball Nose	Effective Length	Length of Cut	Overall Length	Shank Diameter	Page	Model Number		Number of Flutes	Radius of Ball Nose	Effective Length	Length of Cut	Overall Length	Shank Diameter	Page
HGLB	2020-040-6	2 Flutes	R1	4	1.6	50	6	439	UDCLB	2020-1000	2 Flutes	R1	10	1.4	50	4	98
HSLB	2020-040-6			4	1.6	50	6	452	HSLB	2020-100S			10	1.6	40	4	466
CSELB	2020-040-6			4	1.6	50	6	474	HGLB	2020-100			10	1.6	45	4	439
CPRB	2020-4			4	1.7	45	4	499	HSLB	2020-100			10	1.6	45	4	452
CFLB	3020-040	3 Flutes	4	1.6	50	4	503	CSELB	2020-100	10			1.6	45	4	474	
CBN-LBSF	2020-050	2 Flutes	5	1.2	50	4	115	DCLB	2020-0100	10			1.6	45	4	485	
CBN-LBF	2020-050		5	1.2	50	4	121	DLCLB	2020-100	10			1.6	45	4	490	
CBN-LBSF	2020-060		6	1.2	50	4	115	HGLB	2020-100-6	10			1.6	50	6	439	
CBN-LBF	2020-060		6	1.2	50	4	121	HSLB	2020-100-6	10			1.6	50	6	452	
UDCLBF	2020-0600		6	1.4	50	4	83	CSELB	2020-100-6	10			1.6	50	6	474	
UDCLB	2020-0600		6	1.4	50	4	98	CPRB	2020-10	10			1.7	45	4	499	
HSLB	2020-060S		6	1.6	35	4	466	CFLB	3020-100	3 Flutes			10	1.6	50	4	503
HGLB	2020-060		6	1.6	45	4	439	CBN-LBF	2020-120	2 Flutes			12	1.2	50	4	121
HSLB	2020-060		6	1.6	45	4	452	UDCLBF	2020-1200				12	1.4	50	4	83
CSELB	2020-060		6	1.6	45	4	474	HGLB	2020-120				12	1.6	45	4	439
DCLB	2020-0060		6	1.6	45	4	485	HSLB	2020-120				12	1.6	45	4	452
DLCLB	2020-060		6	1.6	45	4	490	HSLB	2020-120S		12	1.6	45	4	466		
HGLB	2020-060-6		6	1.6	50	6	439	CSELB	2020-120		12	1.6	45	4	474		
HSLB	2020-060-6		6	1.6	50	6	452	DCLB	2020-0120		12	1.6	45	4	485		
CSELB	2020-060-6		6	1.6	50	6	474	DLCLB	2020-120		12	1.6	50	4	490		
CPRB	2020-6		6	1.7	45	4	499	HGLB	2020-120-6		12	1.6	50	6	439		
CFLB	3020-060	3 Flutes	6	1.6	50	4	503	HSLB	2020-120-6		12	1.6	50	6	452		
CBN-LBSF	2020-080	2 Flutes	8	1.2	50	4	115	CSELB	2020-120-6		12	1.6	50	6	474		
CBN-LBF	2020-080		8	1.2	50	4	121	CPRB	2020-12		12	1.7	45	4	499		
UDCLBF	2020-0800		8	1.4	50	4	83	CFLB	3020-120		3 Flutes	12	1.6	50	4	503	
UDCLB	2020-0800		8	1.4	50	4	98	HSLB	2020-130		2 Flutes	13	1.6	45	4	452	
HSLB	2020-080S		8	1.6	40	4	466	CSELB	2020-130			13	1.6	45	4	474	
HGLB	2020-080		8	1.6	45	4	439	CBN-LBF	2020-140			14	1.2	50	4	121	
HSLB	2020-080		8	1.6	45	4	452	UDCLBF	2020-1400	14		1.4	50	4	83		
CSELB	2020-080		8	1.6	45	4	474	HGLB	2020-140	14		1.6	45	4	439		
DCLB	2020-0080		8	1.6	45	4	485	HSLB	2020-140S	14		1.6	45	4	466		
DLCLB	2020-080		8	1.6	45	4	490	HSLB	2020-140	14		1.6	50	4	452		
HGLB	2020-080-6		8	1.6	50	6	439	CSELB	2020-140	14		1.6	50	4	474		
HSLB	2020-080-6		8	1.6	50	6	452	DLCLB	2020-140	14		1.6	50	4	490		
CSELB	2020-080-6		8	1.6	50	6	474	CPRB	2020-14	14		1.7	50	4	499		
CPRB	2020-8		8	1.7	45	4	499	CFLB	3020-140	3 Flutes		14	1.6	50	4	503	
CFLB	3020-080		3 Flutes	8	1.6	50	4	503	CBN-LBF	2020-160		2 Flutes	16	1.2	50	4	121
CBN-LBSF	2020-100		10	1.2	50	4	115	UDCLBF	2020-1600	16			1.4	50	4	83	
CBN-LBF	2020-100	10	1.2	50	4	121	HGLB	2020-160	16	1.6			45	4	439		
UDCLBF	2020-1000	10	1.4	50	4	83	HSLB	2020-160	16	1.6			50	4	452		

Simplified Table

Ball																		
Model Number	Number of Flutes	Radius of Ball Nose	Effective Length	Length of Cut	Overall Length	Shank Diameter	Page	Model Number	Number of Flutes	Radius of Ball Nose	Effective Length	Length of Cut	Overall Length	Shank Diameter	Page			
HSLB	2020-160S	R1	2 Flutes	16	1.6	50	4 466	HGLB	2020-300	R1	2 Flutes	30	1.6	70	4 439			
CSELB	2020-160			16	1.6	50	4 474	HSLB	2020-300			30	1.6	70	4 452			
DCLB	2020-0160			16	1.6	50	4 485	CSELB	2020-300			30	1.6	70	4 474			
DLCLB	2020-160			16	1.6	50	4 490	DCLB	2020-0300-16			30	1.6	70	4 485			
HSLB	2020-160-6			16	1.6	60	6 452	HSLB	2020-300-6			30	1.6	80	6 452			
CSELB	2020-160-6			16	1.6	60	6 474	CSELB	2020-300-6			30	1.6	80	6 474			
CPRB	2020-16			16	1.7	50	4 499	CPRB	2020-30			30	1.7	70	4 499			
CFLB	3020-160			3 Flutes	16	1.6	50	4 503	DCLB			2020-0300	30	3	70	4 485		
CBN-LBF	2020-180			2 Flutes	18	1.2	50	4 121	HSLB			2020-320	32	1.6	70	4 452		
UDCLBF	2020-1800				18	1.4	60	4 83	CSELB			2020-320	32	1.6	70	4 474		
HSLB	2020-180			2 Flutes	18	1.6	55	4 452	HSLB			2020-350	35	1.6	80	4 452		
CSELB	2020-180				18	1.6	55	4 474	CSELB			2020-350	35	1.6	80	4 474		
CFLB	3020-180			3 Flutes	18	1.6	55	4 503	HSLB			2020-350-6	35	1.6	80	6 452		
CBN-LBF	2020-200			2 Flutes	20	1.2	50	4 121	CSELB			2020-350-6	35	1.6	80	6 474		
UDCLBF	2020-2000				20	1.4	60	4 83	DCLB			2020-0350	35	3	70	4 485		
HSLB	2020-200S			R1	2 Flutes	20	1.6	50	4 466			HSLB	2020-400	40	1.6	80	4 452	
HSLB	2020-200					20	1.6	55	4 452			CSELB	2020-400	40	1.6	80	4 474	
CSELB	2020-200					20	1.6	55	4 474			DCLB	2020-0400	40	1.6	80	4 485	
DLCLB	2020-200					20	1.6	55	4 490			HSLB	2020-400-6	40	1.6	90	6 452	
HGLB	2020-200					20	1.6	60	4 439			CSELB	2020-400-6	40	1.6	90	6 474	
DCLB	2020-0200-16					20	1.6	60	4 485			HSB	2025-0250	—	2.5	50	4 399	
HSLB	2020-200-6					20	1.6	70	6 452			CSEB	2025-0250	—	2.5	50	4 407	
CSELB	2020-200-6					20	1.6	70	6 474			HSB	2025-0250-6	—	2.5	60	6 399	
CPRB	2020-20					20	1.7	55	4 499			CSEB	2025-0250-6	—	2.5	60	6 407	
DCLB	2020-0200					20	3	70	4 485			HGB	2025-0375	—	3.75	50	4 396	
CFLB	3020-200					3 Flutes	20	1.6	55			4 503	HSB	2025-0375	—	3.75	50	4 399
HSLB	2020-220					2 Flutes	22	1.6	60			4 452	CSEB	2025-0375	—	3.75	50	4 407
CSELB	2020-220						22	1.6	60			4 474	HSB	2025-0600	—	6	60	4 399
CPRB	2020-22	2 Flutes	22			1.7	60	4 499	CSEB	2025-0600	—	6	60	4 407				
HGLB	2020-250		25			1.6	60	4 439	CGB	2025	—	10	70	4 414				
HSLB	2020-250	R1.25	2 Flutes			25	1.6	65	4 452	HSLB	2025-060	6	2	45	4 452			
CSELB	2020-250					25	1.6	65	4 474	CSELB	2025-060	6	2	45	4 474			
DCLB	2020-0250					25	1.6	65	4 485	HSLB	2025-080	8	2	45	4 452			
DLCLB	2020-250					25	1.6	65	4 490	CSELB	2025-080	8	2	45	4 474			
HSLB	2020-250-6					25	1.6	80	6 452	HSLB	2025-100	10	2	45	4 452			
CSELB	2020-250-6					25	1.6	80	6 474	CSELB	2025-100	10	2	45	4 474			
CPRB	2020-25					25	1.7	65	4 499	HSLB	2025-150	15	2	50	4 452			
DCLB	2020-0250-30					25	3	65	4 485	CSELB	2025-150	15	2	50	4 474			
HSLB	2020-270					27	1.6	65	4 452	HSLB	2025-200	20	2	55	4 452			
CSELB	2020-270					27	1.6	65	4 474	CSELB	2025-200	20	2	55	4 474			

Simplified Table

Ball

Model Number	Number of Flutes	Radius of Ball Nose	Effective Length	Length of Cut	Overall Length	Shank Diameter	Page	Model Number	Number of Flutes	Radius of Ball Nose	Effective Length	Length of Cut	Overall Length	Shank Diameter	Page		
HSLB 2025-250	2 Flutes	R1.25	25	2	65	4	452	CFLB 3030-080	3 Flutes	R1.5	8	2.4	60	6	503		
CSELB 2025-250			25	2	65	4	474	UDCLBF 2030-1000			10	2.1	60	6	83		
HSLB 2025-300			30	2	70	4	452	UDCLB 2030-1000			10	2.1	60	6	98		
CSELB 2025-300			30	2	70	4	474	HSLB 2030-100-4S	10		2.4	40	4	466			
HSLB 2025-350			35	2	70	4	452	HGLB 2030-100	10		2.4	60	6	439			
CSELB 2025-350			35	2	70	4	474	HSLB 2030-100	10		2.4	60	6	453			
UDCBF 2030-0210	2 Flutes	R1.5	—	2.1	60	6	80	CSELB 2030-100	3 Flutes	10	2.4	60	6	475			
UDCB 2030-0210			—	2.1	60	6	94	DCLB 2030-100		10	2.4	60	6	492			
HSB 2030-0300S			—	3	40	6	403	CPRB 2030-10		10	2.5	60	6	500			
HSB 2030-0300			—	3	50	6	399	CFLB 3030-100	3 Flutes	10	2.4	60	6	503			
CSEB 2030-0300			—	3	50	6	407	UDCLBF 2030-1200		12	2.1	60	6	83			
HGB 2030-0450			—	4.5	50	6	396	UDCLB 2030-1200		12	2.1	60	6	98			
HSB 2030-0450			—	4.5	70	6	399	HSLB 2030-120-4S	2 Flutes	12	2.4	40	4	466			
CSEB 2030-0450			—	4.5	70	6	407	HGLB 2030-120		12	2.4	60	6	439			
HBL 2030-0800			—	4.5	80	3	404	HSLB 2030-120		12	2.4	60	6	453			
HSB 2030-0800			—	8	70	6	399	CSELB 2030-120	3 Flutes	12	2.4	60	6	475			
CSEB 2030-0800			—	8	70	6	407	DCLB 2030-120		12	2.4	60	6	492			
DCB 2030			—	15	80	4	412	CPRB 2030-12		12	2.5	60	6	500			
CGB 2030			3 Flutes	R1.5	—	15	80	4	414	CFLB 3030-120	3 Flutes	12	2.4	60	6	503	
CFB 3030-0450					—	4.5	60	6	416	UDCLBF 2030-1400		14	2.1	60	6	83	
DLC-CFB 3030-0450					—	4.5	60	6	422	UDCLB 2030-1400		14	2.1	60	6	98	
HFB 4030-0450S			4 Flutes	R1.5	—	4.5	40	4	427	HGLB 2030-140	2 Flutes	14	2.4	60	6	439	
HFB 4030-0450					—	4.5	60	6	426	HSLB 2030-140		14	2.4	60	6	453	
UDCLBF 2030-0600			2 Flutes	R1.5	6	2.1	60	6	83	CSELB 2030-140		14	2.4	60	6	475	
UDCLB 2030-0600					6	2.1	60	6	98	DCLB 2030-140		14	2.4	60	6	492	
HSLB 2030-060-4S					6	2.4	35	4	466	HSLB 2030-150		15	2.4	60	6	453	
HSLB 2030-060-3	6	2.4			60	3	453	CSELB 2030-150	2 Flutes	15		2.4	60	6	475		
CSELB 2030-060-3	6	2.4			60	3	475	HSLB 2030-160-4S		16		2.4	45	4	466		
HSLB 2030-060-4	6	2.4			60	4	453	HGLB 2030-160		16		2.4	60	6	439		
CSELB 2030-060-4	6	2.4			60	4	475	HSLB 2030-160	3 Flutes	16		2.4	60	6	453		
HGLB 2030-060	6	2.4			60	6	439	CSELB 2030-160		16		2.4	60	6	475		
HSLB 2030-060	6	2.4			60	6	453	DCLB 2030-0160		16		2.4	60	6	485		
CSELB 2030-060	2 Flutes	R1.5			6	2.4	60	6	475	DCLB 2030-160		2 Flutes	16	2.4	60	6	492
UDCLBF 2030-0800					8	2.1	60	6	83	CPRB 2030-16			16	2.5	60	6	500
UDCLB 2030-0800					8	2.1	60	6	98	CFLB 3030-160			3 Flutes	16	2.4	60	6
HSLB 2030-080-4S					8	2.4	40	4	466	HGLB 2030-180		18		2.4	60	6	439
HGLB 2030-080					8	2.4	60	6	439	HSLB 2030-180		18		2.4	60	6	453
HSLB 2030-080					8	2.4	60	6	453	CSELB 2030-180		2 Flutes	18	2.4	60	6	475
CSELB 2030-080					8	2.4	60	6	475	HSLB 2030-200-4S			20	2.4	50	4	466
CPRB 2030-8					8	2.5	60	6	500	DCLB 2030-0200			20	2.4	60	6	485

Simplified Table

Ball							
Model Number	Number of Flutes	Radius of Ball Nose	Effective Length	Length of Cut	Overall Length	Shank Diameter	Page
HGLB 2030-200	2 Flutes	R1.5	20	2.4	70	6	439
HSLB 2030-200			20	2.4	70	6	453
CSELB 2030-200			20	2.4	70	6	475
DLCLB 2030-200			20	2.4	70	6	492
CPRB 2030-20			20	2.5	70	6	500
CFLB 3030-200	3 Flutes		20	2.4	70	6	503
HGLB 2030-220	2 Flutes		22	2.4	70	6	439
HSLB 2030-220			22	2.4	70	6	453
CSELB 2030-220			22	2.4	70	6	475
HGLB 2030-250			25	2.4	70	6	439
HSLB 2030-250			25	2.4	70	6	453
CSELB 2030-250			25	2.4	70	6	475
DCLB 2030-0250			25	2.4	70	6	485
DLCLB 2030-250			25	2.4	70	6	492
CPRB 2030-25			25	2.5	70	6	500
CFLB 3030-250			3 Flutes	25	2.4	70	6
HGLB 2030-270	2 Flutes		27	2.4	70	6	439
HSLB 2030-270			27	2.4	70	6	453
CSELB 2030-270			27	2.4	70	6	475
HGLB 2030-300			30	2.4	70	6	439
HSLB 2030-300		30	2.4	70	6	453	
CSELB 2030-300		30	2.4	70	6	475	
DLCLB 2030-300		30	2.4	70	6	492	
DCLB 2030-0300-S6		30	2.4	80	6	485	
CPRB 2030-30		30	2.5	70	6	500	
DCLB 2030-0300		30	4.5	80	4	485	
HSLB 2030-320	2 Flutes	32	2.4	80	6	453	
CSELB 2030-320		32	2.4	80	6	475	
HSLB 2030-350		35	2.4	80	6	453	
CSELB 2030-350		35	2.4	80	6	475	
CPRB 2030-35		35	2.5	80	6	500	
HSLB 2030-400		40	2.4	80	6	453	
CSELB 2030-400		40	2.4	80	6	475	
DCLB 2030-0400-S6		40	2.4	80	6	485	
DCLB 2030-0400		40	4.5	80	4	485	
CSEB 2035-0520		2 Flutes	—	5.2	70	6	407
HSLB 2035-100	10		2.8	60	6	453	
CSELB 2035-100	10		2.8	60	6	475	
HSLB 2035-150	15		2.8	60	6	453	
CSELB 2035-150	15		2.8	60	6	475	
HSLB 2035-200	2 Flutes		20	2.8	65	6	453
CSELB 2035-200		20	2.8	65	6	475	
HSLB 2035-250		25	2.8	70	6	453	
CSELB 2035-250		25	2.8	70	6	475	
HSLB 2035-300		30	2.8	70	6	453	
CSELB 2035-300		30	2.8	70	6	475	
HSLB 2035-400		40	2.8	90	6	453	
CSELB 2035-400		40	2.8	90	6	475	
HSLB 2035-450		45	2.8	90	6	453	
CSELB 2035-450		45	2.8	90	6	475	
UDCBF 2040-0280	2 Flutes	R1.75	—	2.8	60	6	80
UDCB 2040-0280			—	2.8	60	6	94
HSB 2040-0400S			—	4	40	6	403
HSB 2040-0400			—	4	50	6	399
CSEB 2040-0400			—	4	50	6	407
HGB 2040-0600			—	6	50	6	396
HSB 2040-0600-4			—	6	70	4	399
CSEB 2040-0600-4			—	6	70	4	407
HSB 2040-0600			—	6	70	6	399
CSEB 2040-0600			—	6	70	6	407
HBL 2040-1000	—	6	100	4	404		
HSB 2040-0800	2 Flutes	R2	—	8	70	6	399
CSEB 2040-0800			—	8	70	6	407
DCB 2040			—	20	100	4	412
DCB 2040			—	20	100	4	414
CFB 3040-0600-4			—	6	70	4	416
DLC-CFB 3040-0600-4			—	6	70	4	422
CFB 3040-0600			—	6	70	6	416
DLC-CFB 3040-0600			—	6	70	6	422
HFB 4040-0600S			—	6	45	6	427
HFB 4040-0600			—	6	70	6	426
CGB 4040	—	20	100	4	432		
UDCLBF 2040-0800	2 Flutes	R2	8	2.8	60	6	83
UDCLB 2040-0800			8	2.8	60	6	98
HSLB 2040-080-4S			8	3.2	35	4	466
HSLB 2040-080-4			8	3.2	70	4	453
CSELB 2040-080-4			8	3.2	70	4	475
HGLB 2040-080			8	3.2	70	6	440
HSLB 2040-080			8	3.2	70	6	453
CSELB 2040-080			8	3.2	70	6	475

Simplified Table

Ball

Model Number	Number of Flutes	Radius of Ball Nose	Effective Length	Length of Cut	Overall Length	Shank Diameter	Page	Model Number	Number of Flutes	Radius of Ball Nose	Effective Length	Length of Cut	Overall Length	Shank Diameter	Page	
UDCLBF 2040-1000	2 Flutes	R2	10	2.8	60	6	83	CFLB 3040-200	3 Flutes	R2	20	3.2	70	6	503	
UDCLB 2040-1000			10	2.8	60	6	98	HGLB 2040-220	2 Flutes		22	3.2	70	6	440	
CPRB 2040-10			10	3	70	6	500	HSLB 2040-220			22	3.2	70	6	453	
HSLB 2040-100-4S			10	3.2	40	4	466	CSELB 2040-220			22	3.2	70	6	475	
HGLB 2040-100			10	3.2	70	6	440	CPRB 2040-25			25	3	70	6	500	
HSLB 2040-100			10	3.2	70	6	453	HGLB 2040-250			25	3.2	70	6	440	
CSELB 2040-100			10	3.2	70	6	475	HSLB 2040-250			25	3.2	70	6	453	
DLCLB 2040-100			10	3.2	70	6	492	CSELB 2040-250			25	3.2	70	6	475	
CFLB 3040-100			3 Flutes	10	3.2	70	6	503			DCLB 2040-0250	25	3.2	70	6	485
CPRB 2040-12			2 Flutes	12	3	70	6	500			DLCLB 2040-250	25	3.2	70	6	492
HSLB 2040-120-4S	12	3.2		40	4	466	CFLB 3040-250	3 Flutes		25	3.2	70	6	503		
HGLB 2040-120	12	3.2		70	6	440	HGLB 2040-270	2 Flutes	27	3.2	70	6	440			
HSLB 2040-120	12	3.2		70	6	453	HSLB 2040-270		27	3.2	70	6	453			
CSELB 2040-120	12	3.2		70	6	475	CSELB 2040-270		27	3.2	70	6	475			
CFLB 3040-120	3 Flutes	12		3.2	70	6	503		CPRB 2040-30	30	3	70	6	500		
HGLB 2040-140	2 Flutes	14		3.2	70	6	440		HGLB 2040-300	30	3.2	70	6	440		
HSLB 2040-140		14		3.2	70	6	453		HSLB 2040-300	30	3.2	70	6	453		
CSELB 2040-140		14		3.2	70	6	475		CSELB 2040-300	30	3.2	70	6	475		
UDCLBF 2040-1500		15		2.8	60	6	83		DCLB 2040-0300	30	3.2	70	6	485		
UDCLB 2040-1500		15	2.8	60	6	98	DLCLB 2040-300		30	3.2	70	6	492			
HSLB 2040-150		15	3.2	70	6	453	DCLB 2040-0300-60		30	6	100	4	485			
CSELB 2040-150		15	3.2	70	6	475	CFLB 3040-300	3 Flutes	30	3.2	70	6	503			
DLCLB 2040-150		15	3.2	70	6	492	HSLB 2040-320	2 Flutes	32	3.2	80	6	453			
CPRB 2040-16		16	3	70	6	500	CSELB 2040-320		32	3.2	80	6	475			
HSLB 2040-160-4S		16	3.2	45	4	466	CPRB 2040-35		35	3	80	6	500			
HGLB 2040-160	16	3.2	70	6	440	HGLB 2040-350	35		3.2	80	6	440				
HSLB 2040-160	16	3.2	70	6	453	HSLB 2040-350	35		3.2	80	6	453				
CSELB 2040-160	16	3.2	70	6	475	CSELB 2040-350	35		3.2	80	6	475				
DCLB 2040-0160	16	3.2	70	6	485	CPRB 2040-40	40		3	90	6	500				
CFLB 3040-160	3 Flutes	16	3.2	70	6	503	DLCLB 2040-400		40	3.2	80	6	492			
HGLB 2040-180	2 Flutes	18	3.2	70	6	440	HGLB 2040-400		40	3.2	90	6	440			
HSLB 2040-180		18	3.2	70	6	453	HSLB 2040-400		40	3.2	90	6	453			
CSELB 2040-180		18	3.2	70	6	475	CSELB 2040-400	40	3.2	90	6	475				
CPRB 2040-20		20	3	70	6	500	DCLB 2040-0400-S6	40	3.2	90	6	485				
HSLB 2040-200-4S		20	3.2	50	4	466	DCLB 2040-0400	40	6	100	4	485				
HGLB 2040-200		20	3.2	70	6	440	CPRB 2040-45	45	3	90	6	500				
HSLB 2040-200		20	3.2	70	6	453	HSLB 2040-450	45	3.2	90	6	453				
CSELB 2040-200		20	3.2	70	6	475	CSELB 2040-450	45	3.2	90	6	475				
DCLB 2040-0200		20	3.2	70	6	485	CPRB 2040-50	50	3	100	6	500				
DLCLB 2040-200		20	3.2	70	6	492	HSLB 2040-500	50	3.2	100	6	453				

Simplified Table

Ball									
Model Number	Number of Flutes	Radius of Ball Nose	Effective Length	Length of Cut	Overall Length	Shank Diameter	Page		
CSELB 2040-500	2 Flutes	R2	50	3.2	100	6	475		
DCLB 2040-0500-S6			50	3.2	100	6	485		
DCLB 2040-0500			50	6	100	4	485		
HSLB 2040-600			60	3.2	120	6	453		
CSELB 2040-600			60	3.2	120	6	475		
DCLB 2040-0600			60	6	100	4	485		
CSEB 2045-0670	2 Flutes	R2.25	—	6.7	70	6	407		
UDCBF 2050-0350	2 Flutes	R2.5	—	3.5	60	6	80		
UDCB 2050-0350			—	3.5	60	6	94		
HSB 2050-0500			—	5	50	6	399		
CSEB 2050-0500			—	5	50	6	407		
HGB 2050-0750			—	7.5	50	6	396		
HSB 2050-0750			—	7.5	80	6	399		
CSEB 2050-0750			—	7.5	80	6	407		
HSB 2050-0800			—	8	80	6	399		
CSEB 2050-0800			—	8	80	6	407		
HSB 2050-1200			—	12	80	6	399		
CSEB 2050-1200			—	12	80	6	407		
DCB 2050			—	20	100	5	412		
CGB 2050			—	20	100	5	414		
CFB 3050-0750			3 Flutes	R2.5	—	7.5	80	6	416
DLC-CFB 3050-0750			—		7.5	80	6	422	
CGB 4050			4 Flutes		—	20	100	5	432
UDCLBF 2050-1000			2 Flutes		10	3.5	60	6	83
UDCLB 2050-1000					10	3.5	60	6	98
HSLB 2050-100					10	4	70	6	454
CSELB 2050-100					10	4	70	6	476
UDCLBF 2050-1500	15	3.5			60	6	83		
UDCLB 2050-1500	15	3.5			60	6	98		
HSLB 2050-150	15	4			70	6	454		
CSELB 2050-150	15	4			70	6	476		
CPRB 2050-20	20	3.5			70	6	500		
HSLB 2050-200	20	4			70	6	454		
CSELB 2050-200	20	4			70	6	476		
DCLB 2050-0200	20	4			70	6	485		
CPRB 2050-25	25	3.5			70	6	500		
HSLB 2050-250	25	4			70	6	454		
CSELB 2050-250	25	4			70	6	476		
CPRB 2050-30	30	3.5			80	6	500		
HSLB 2050-300	30	4			80	6	454		
CSELB 2050-300	2 Flutes	R2.5		30	4	80	6	476	
DCLB 2050-0300				30	4	80	6	485	
DCLB 2050-0300				35	3.5	80	6	500	
CPRB 2050-35			35	4	80	6	454		
HSLB 2050-350			35	4	80	6	476		
CSELB 2050-350			35	4	80	6	476		
HSLB 2050-400			40	4	90	6	454		
CSELB 2050-400			40	4	90	6	476		
HSLB 2050-450			45	4	100	6	454		
CSELB 2050-450			45	4	100	6	476		
HSLB 2050-500			50	4	100	6	454		
CSELB 2050-500			50	4	100	6	476		
CSEB 2055-0820			2 Flutes	R2.75	—	8.2	80	6	407
UDCBF 2060-0420			2 Flutes	R3	—	4.2	60	6	80
UDCB 2060-0420					—	4.2	60	6	94
HSB 2060-0600					—	6	50	6	399
CSEB 2060-0600					—	6	50	6	407
HGB 2060-0900					—	9	50	6	396
HSB 2060-0900					—	9	80	6	399
CSEB 2060-0900					—	9	80	6	407
HSB 2060-1200	—	12			80	6	399		
CSEB 2060-1200	—	12			80	6	407		
HBL 2060-1400	—	18			140	6	404		
DCB 2060	—	30			150	6	412		
CGB 2060	—	30			150	6	414		
CFB 3060-0900	3 Flutes	R3			—	9	80	6	416
DLC-CFB 3060-0900	—				9	80	6	422	
HFB 4060-0900S	4 Flutes				—	9	50	6	427
HFB 4060-0900					—	9	80	6	426
CGB 4060	—				30	150	6	432	
UDCLBF 2060-1000	2 Flutes				10	4.2	60	6	83
UDCLB 2060-1000					10	4.2	60	6	98
HGLB 2060-100					10	4.8	80	6	440
HSLB 2060-100			10	4.8	80	6	454		
CSELB 2060-100			10	4.8	80	6	476		
DCLB 2060-100			10	4.8	80	6	492		
UDCLBF 2060-1500			15	4.2	60	6	83		
UDCLB 2060-1500			15	4.2	60	6	98		
HSLB 2060-150S			15	4.8	45	6	466		
HGLB 2060-150			15	4.8	80	6	440		
HSLB 2060-150			15	4.8	80	6	454		

Simplified Table

Ball

Model Number	Number of Flutes	Radius of Ball Nose	Effective Length	Length of Cut	Overall Length	Shank Diameter	Page	Model Number	Number of Flutes	Radius of Ball Nose	Effective Length	Length of Cut	Overall Length	Shank Diameter	Page				
CSELB 2060-150	2 Flutes	R3	15	4.8	80	6	476	HSLB 2060-500	2 Flutes	R3	50	4.8	120	6	454				
DLCLB 2060-150			15	4.8	80	6	492	CSELB 2060-500			50	4.8	120	6	476				
HGLB 2060-180			18	4.8	80	6	440	DCLB 2060-0500			50	4.8	120	6	485				
HSLB 2060-180			18	4.8	80	6	454	CPRB 2060-50			50	6	120	6	500				
CSELB 2060-180			18	4.8	80	6	476	HSLB 2060-600			60	4.8	120	6	454				
HSLB 2060-200S			20	4.8	50	6	466	CSELB 2060-600			60	4.8	120	6	476				
HGLB 2060-200			20	4.8	80	6	440	DCLB 2060-0600			60	4.8	120	6	485				
HSLB 2060-200			20	4.8	80	6	454	DCLB 2060-0700			70	4.8	120	6	485				
CSELB 2060-200			20	4.8	80	6	476	DCLB 2060-0800			80	4.8	120	6	485				
DLCLB 2060-200			20	4.8	80	6	492	CSEB 2065-0970			2 Flutes	R3.25	—	9.7	90	8	407		
CFLB 3060-200			3 Flutes	R3	20	4.8	80	6			503	CSEB 2070-1050	2 Flutes	R3.5	—	10.5	90	8	407
HSLB 2060-220					22	4.8	80	6			454	CGB 2070	2 Flutes		—	30	150	6	414
CSELB 2060-220	2 Flutes	R3	22	4.8	80	6	476	CGB 4070	4 Flutes	—	30	150	6	432					
HGLB 2060-250			25	4.8	80	6	440	CSEB 2075-1120	2 Flutes	R3.75	—	11.2	90	8	407				
HSLB 2060-250			25	4.8	80	6	454	HSB 2080-0800	2 Flutes	R4	—	8	60	8	399				
CSELB 2060-250			25	4.8	80	6	476	CSEB 2080-0800			—	8	60	8	407				
CFLB 3060-250	3 Flutes	25	4.8	80	6	503	HSB 2080-1200	—			12	90	8	399					
HSLB 2060-270		27	4.8	80	6	454	CSEB 2080-1200	—			12	90	8	407					
CSELB 2060-270	2 Flutes	27	4.8	80	6	476	HSB 2080-1400	—			14	90	8	399					
HGLB 2060-300		30	4.8	80	6	440	CSEB 2080-1400	—			14	90	8	407					
HSLB 2060-300		30	4.8	80	6	454	HBL 2080-1600	—			20	160	8	404					
CSELB 2060-300		30	4.8	80	6	476	DCB 2080	—			40	150	8	412					
DCLB 2060-0300		30	4.8	80	6	485	CGB 2080	—			40	150	8	414					
DLCLB 2060-300		30	4.8	80	6	492	CFB 3080-1200	3 Flutes			—	12	90	8	416				
CPRB 2060-30	30	6	80	6	500	DLC-CFB 3080-1200	—				12	90	8	422					
CFLB 3060-300	3 Flutes	30	4.8	80	6	503	CFB 3080-1200LS				—	12	120	8	416				
HSLB 2060-320		32	4.8	80	6	454	DLC-CFB 3080-1200LS		—	12	120	8	422						
CSELB 2060-320	2 Flutes	32	4.8	80	6	476	HFB 4080-1200S	4 Flutes	—	12	60	8	427						
HGLB 2060-350		35	4.8	80	6	440	HFB 4080-1200		—	12	90	8	426						
HSLB 2060-350		35	4.8	80	6	454	CGB 4080	—	40	150	8	432							
CSELB 2060-350		35	4.8	80	6	476	CSEB 2085-1270	2 Flutes	R4.25	—	12.7	100	10	407					
CFLB 3060-350	3 Flutes	35	4.8	80	6	503	CSEB 2090-1350	2 Flutes	R4.5	—	13.5	100	10	407					
HGLB 2060-400		40	4.8	90	6	440	HSB 2100-1000	2 Flutes	R5	—	10	70	10	399					
HSLB 2060-400	40	4.8	90	6	454	CSELB 2100-1000	—			10	70	10	407						
CSELB 2060-400	40	4.8	90	6	476	HSB 2100-1500	—			15	100	10	399						
DCLB 2060-0400	40	4.8	100	6	485	CSELB 2100-1500	—			15	100	10	407						
CFLB 3060-400	3 Flutes	40	4.8	90	6	503	HSB 2100-1800			—	18	100	10	399					
HSLB 2060-450		45	4.8	100	6	454	CSELB 2100-1800			—	18	100	10	407					
CSELB 2060-450	2 Flutes	45	4.8	100	6	476	HBL 2100-1800	—	25	180	10	404							
HGLB 2060-500		50	4.8	120	6	440	DCB 2100	—	50	180	10	412							

Simplified Table

Ball

Model Number	Number of Flutes	Radius of Ball Nose	Effective Length	Length of Cut	Overall Length	Shank Diameter	Page	
CGB 2100	2 Flutes	R5	—	50	180	10	414	
CFB 3100-1500	3 Flutes		—	15	100	10	416	
DLC-CFB 3100-1500			—	15	100	10	422	
HFB 4100-1500S	4 Flutes		—	15	60	10	427	
HFB 4100-1500			—	15	100	10	426	
CGB 4100			—	50	180	10	432	
CSEB 2110-1650	2 Flutes	R5.5	—	16.5	110	12	407	
CGB 2110	—		50	180	10	414		
HSB 2120-1200	2 Flutes	R6	—	12	75	12	399	
CSEB 2120-1200			—	12	75	12	407	
HSB 2120-1800			—	18	110	12	399	
CSEB 2120-1800			—	18	110	12	407	
HSB 2120-2200			—	22	110	12	399	
CSEB 2120-2200			—	22	110	12	407	
HBL 2120-2000			—	25	200	12	404	
DCB 2120			—	55	180	12	412	
CGB 2120			—	55	200	12	414	
CFB 3120-1800			3 Flutes	—	18	110	12	416
DLC-CFB 3120-1800				—	18	110	12	422
HFB 4120-1800S			4 Flutes	—	18	60	12	427
HFB 4120-1800				—	18	110	12	426
CGB 4120				—	55	200	12	432
CGB 4160	4 Flutes	R8	—	60	200	16	432	
CGB 4200	4 Flutes	R10	—	60	250	20	432	

Simplified Table

Radius

Model Number	Number of Flutes	Outside Diameter	Corner Radius	Effective Length	Length of Cut	Overall Length	Shank Diameter	Page	
CBN-LRF 2001-002002	2 Flutes	0.1	R0.02	0.2	0.04	50	4	132	
CBN-LRF 2001-002003			R0.02	0.3	0.04	50	4	132	
CBN-LRF 2001-002005			R0.02	0.5	0.04	50	4	132	
CBN-LRF 2001-003002			R0.03	0.2	0.04	50	4	132	
CBN-LRF 2001-003003			R0.03	0.3	0.04	50	4	132	
CBN-LRF 2001-003005			R0.03	0.5	0.04	50	4	132	
CBN-LRF 20015-002X2	2 Flutes	0.15	R0.02	0.2	0.06	50	4	132	
CBN-LRF 20015-002X3			R0.02	0.3	0.06	50	4	132	
CBN-LRF 20015-002X5			R0.02	0.5	0.06	50	4	132	
CBN-LRF 20015-003X2			R0.03	0.2	0.06	50	4	132	
CBN-LRF 20015-003X3			R0.03	0.3	0.06	50	4	132	
CBN-LRF 20015-003X5			R0.03	0.5	0.06	50	4	132	
CBN-RSF 1002-002003	1 Flutes	0.2	R0.02	0.3	0.08	50	4	126	
HLRS 4002-002-003	4 Flutes		R0.02	0.3	0.12	50	4	338	
CBN-RSF 1002-002005	1 Flutes		R0.02	0.5	0.08	50	4	126	
CBN-LRF 2002-002005	2 Flutes		R0.02	0.5	0.08	50	4	133	
HLRS 4002-002-005	4 Flutes		R0.02	0.5	0.12	50	4	338	
UPDLRS 1002-002-006	1 Flutes		R0.02	0.6	0.1	40	4	316	
CBN-LRF 2002-002X75	2 Flutes		R0.02	0.75	0.08	50	4	133	
CBN-LRF 2002-002010			R0.02	1	0.08	50	4	133	
HLRS 4002-002-010	4 Flutes		R0.02	1	0.12	50	4	338	
HLRS 4002-002-015			R0.02	1.5	0.12	50	4	338	
HLRS 4002-002-020			R0.02	2	0.12	50	4	338	
CBN-LRF 2002-003005	2 Flutes		R0.03	0.5	0.08	50	4	133	
CBN-LRF 2002-003X75			R0.03	0.75	0.08	50	4	133	
CBN-LRF 2002-003010	2 Flutes		R0.03	1	0.08	50	4	133	
CBN-RSF 1002-005003			1 Flutes	R0.05	0.3	0.08	50	4	126
HLRS 4002-005-003			4 Flutes	R0.05	0.3	0.12	50	4	338
CBN-RSF 1002-005005			1 Flutes	R0.05	0.5	0.08	50	4	126
CBN-LRF 2002-005005			2 Flutes	R0.05	0.5	0.08	50	4	133
HLRS 2002-005-005E				R0.05	0.5	0.2	50	4	318
UPDLRS 1002-005-006			1 Flutes	R0.05	0.6	0.1	40	4	316
CBN-LRF 2002-005X75			2 Flutes	R0.05	0.75	0.08	50	4	133
CBN-LRF 2002-005010				R0.05	1	0.08	50	4	133
HLRS 2002-005-010E				R0.05	1	0.2	50	4	318
HLRS 2002-005-015E				R0.05	1.5	0.2	50	4	318
HLRS 2002-005-020E		R0.05		2	0.2	50	4	318	
CBN-LRF 20025-005X5	2 Flutes	R0.05		0.5	0.1	50	4	133	
CBN-LRF 20025-X5X75		R0.05	0.75	0.1	50	4	133		
CBN-LRF 20025-X5010		R0.05	1	0.1	50	4	133		

Model Number	Number of Flutes	Outside Diameter	Corner Radius	Effective Length	Length of Cut	Overall Length	Shank Diameter	Page	
CBN-LRF 2003-001010	2 Flutes	0.3	R0.01	1	0.13	50	4	133	
HLRS 4003-002-003	4 Flutes		R0.02	0.3	0.18	50	4	338	
CBN-RSF 1003-002005	1 Flutes		R0.02	0.5	0.13	50	4	126	
CBN-LRF 2003-002005	2 Flutes		R0.02	0.5	0.13	50	4	133	
HLRS 4003-002-005	4 Flutes		R0.02	0.5	0.18	50	4	338	
CBN-LRF 2003-002X75	2 Flutes		R0.02	0.75	0.13	50	4	133	
UPDLRS 1003-002-010	1 Flutes		R0.02	1	0.15	40	4	316	
CBN-RSF 1003-002010	2 Flutes		R0.02	1	0.13	50	4	126	
CBN-LRF 2003-002010			R0.02	1	0.13	50	4	133	
HLRS 4003-002-010	4 Flutes		R0.02	1	0.18	50	4	338	
CBN-LRF 2003-002015	2 Flutes		R0.02	1.5	0.13	50	4	133	
HLRS 4003-002-015	4 Flutes		R0.02	1.5	0.18	50	4	338	
CBN-LRF 2003-002020	2 Flutes		R0.02	2	0.13	50	4	133	
HLRS 4003-002-020	4 Flutes		R0.02	2	0.18	50	4	338	
CBN-LRF 2003-003005	2 Flutes		R0.03	0.5	0.13	50	4	133	
UDCLRSF 2003-003006			R0.03	0.6	0.15	50	4	86	
UDCLRS 2003-003-006			R0.03	0.6	0.15	50	4	102	
CBN-LRF 2003-003X75			R0.03	0.75	0.13	50	4	133	
CBN-LRF 2003-003010			R0.03	1	0.13	50	4	133	
CBN-LRF 2003-003015			R0.03	1.5	0.13	50	4	133	
CBN-LRF 2003-003020			R0.03	2	0.13	50	4	133	
HLRS 4003-005-003			4 Flutes	R0.05	0.3	0.18	50	4	338
CBN-RSF 1003-005005			1 Flutes	R0.05	0.5	0.13	50	4	126
CBN-LRF 2003-005005			2 Flutes	R0.05	0.5	0.13	50	4	133
HLRS 4003-005-005		4 Flutes	R0.05	0.5	0.18	50	4	338	
UDCLRSF 2003-005006		2 Flutes	R0.05	0.6	0.15	50	4	86	
UDCLRS 2003-005-006	R0.05		0.6	0.15	50	4	102		
CBN-LRF 2003-005X75	1 Flutes	R0.05	0.75	0.13	50	4	133		
UPDLRS 1003-005-010		R0.05	1	0.15	40	4	316		
CBN-RSF 1003-005010		R0.05	1	0.13	50	4	126		
CBN-LRF 2003-005010		R0.05	1	0.13	50	4	133		
HLRS 2003-005-010E		R0.05	1	0.3	50	4	318		
CBN-LRF 2003-005015		2 Flutes	R0.05	1.5	0.13	50	4	133	
HLRS 2003-005-015E	R0.05		1.5	0.3	50	4	318		
CBN-LRF 2003-005020	R0.05		2	0.13	50	4	133		
HLRS 2003-005-020E	R0.05		2	0.3	50	4	318		
HLRS 2003-005-025E	R0.05		2.5	0.3	50	4	318		
HLRS 2003-005-030E	R0.05		3	0.3	50	4	318		
CBN-RSF 1004-002005	1 Flutes	0.4	R0.02	0.5	0.24	50	4	127	
CBN-LRF 2004-002005	2 Flutes		R0.02	0.5	0.24	50	4	133	

Simplified Table

Radius									
Model Number	Number of Flutes	Outside Diameter	Corner Radius	Effective Length	Length of Cut	Overall Length	Shank Diameter	Page	
HLRS	4004-002-005	4 Flutes	0.4	R0.02	0.5	0.24	50	4 338	
CBN-LRF	2004-002010	2 Flutes		R0.02	1	0.24	50	4 133	
HLRS	4004-002-010	4 Flutes		R0.02	1	0.24	50	4 338	
CBN-RSF	1004-002015	1 Flutes		R0.02	1.5	0.24	50	4 127	
CBN-LRF	2004-002015	2 Flutes		R0.02	1.5	0.24	50	4 133	
CBN-LRF	2004-002020			R0.02	2	0.24	50	4 133	
HLRS	4004-002-020	4 Flutes		R0.02	2	0.24	50	4 338	
CBN-LRF	2004-003005	2 Flutes		R0.03	0.5	0.24	50	4 133	
CBN-LRF	2004-003010			R0.03	1	0.24	50	4 133	
CBN-LRF	2004-003015			R0.03	1.5	0.24	50	4 133	
CBN-RSF	1004-005005	1 Flutes		R0.05	0.5	0.24	50	4 127	
CBN-LRF	2004-005005	2 Flutes		R0.05	0.5	0.24	50	4 133	
HLRS	4004-005-005	4 Flutes		R0.05	0.5	0.24	50	4 338	
CBN-LRF	2004-005010	2 Flutes		R0.05	1	0.24	50	4 133	
HLRS	2004-005-010E			R0.05	1	0.4	50	4 318	
HLRS	4004-005-010	4 Flutes		R0.05	1	0.24	50	4 338	
CBN-RSF	1004-005015	1 Flutes		R0.05	1.5	0.24	50	4 127	
CBN-LRF	2004-005015	2 Flutes		R0.05	1.5	0.24	50	4 133	
HLRS	2004-005-015E			R0.05	1.5	0.4	50	4 318	
HLRS	4004-005-015	4 Flutes		R0.05	1.5	0.24	50	4 338	
CBN-LRF	2004-005020	2 Flutes		R0.05	2	0.24	50	4 133	
HLRS	2004-005-020E			R0.05	2	0.4	50	4 318	
HLRS	4004-005-020	4 Flutes		R0.05	2	0.24	50	4 338	
HLRS	2004-005-030E	2 Flutes		R0.05	3	0.4	50	4 318	
CBN-LRF	2004-005040			R0.05	4	0.24	50	4 133	
HLRS	2004-005-040E			R0.05	4	0.4	50	4 318	
CBN-LRF	2004-010005			R0.1	0.5	0.24	50	4 133	
CBN-LRF	2004-010010	2 Flutes		R0.1	1	0.24	50	4 133	
HLRS	2004-01-010			R0.1	1	0.4	50	4 318	
HLRS	4004-01-010	4 Flutes		R0.1	1	0.24	50	4 338	
CBN-LRF	2004-010015	2 Flutes		R0.1	1.5	0.24	50	4 133	
HLRS	2004-01-015			R0.1	1.5	0.4	50	4 318	
HLRS	2004-01-020			R0.1	2	0.4	50	4 318	
HLRS	4004-01-020	4 Flutes		R0.1	2	0.24	50	4 338	
HLRS	2004-01-030	2 Flutes		R0.1	3	0.4	50	4 318	
HLRS	2004-01-040			R0.1	4	0.4	50	4 318	
CBN-LRF	2005-001010	2 Flutes		R0.01	1	0.3	50	4 134	
CBN-RSF	1005-002005	1 Flutes		0.5	R0.02	0.5	0.3	50	4 127
CBN-LRF	2005-002005	2 Flutes			R0.02	0.5	0.3	50	4 134
CBN-LRF	2005-002010				R0.02	1	0.3	50	4 134

Model Number	Number of Flutes	Outside Diameter	Corner Radius	Effective Length	Length of Cut	Overall Length	Shank Diameter	Page
HLRS	4005-002-010	4 Flutes	0.5	R0.02	1	0.3	50	4 340
CBN-RSF	1005-002015	1 Flutes		R0.02	1.5	0.3	50	4 127
CBN-LRF	2005-002015	2 Flutes		R0.02	1.5	0.3	50	4 134
CBN-LRF	2005-002020			R0.02	2	0.3	50	4 134
HLRS	4005-002-020	4 Flutes		R0.02	2	0.3	50	4 340
UDCLRSF	2005-003005	2 Flutes		R0.03	0.5	0.25	50	4 86
UDCLRS	2005-003-005			R0.03	0.5	0.25	50	4 102
CBN-LRF	2005-003005			R0.03	0.5	0.3	50	4 134
UDCLRSF	2005-003010	2 Flutes		R0.03	1	0.25	50	4 86
UDCLRS	2005-003-010			R0.03	1	0.25	50	4 102
CBN-LRF	2005-003010	2 Flutes		R0.03	1	0.3	50	4 134
UDCLRSF	2005-003015			R0.03	1.5	0.25	50	4 86
CBN-LRF	2005-003015			R0.03	1.5	0.3	50	4 134
CBN-LRF	2005-003020	2 Flutes		R0.03	2	0.3	50	4 134
CBN-RSF	1005-005005			1 Flutes	R0.05	0.5	0.3	50
UDCLRSF	2005-005005	2 Flutes		R0.05	0.5	0.25	50	4 86
UDCLRS	2005-005-005			R0.05	0.5	0.25	50	4 102
CBN-LRF	2005-005005			R0.05	0.5	0.3	50	4 134
UDCLRSF	2005-005010	2 Flutes		R0.05	1	0.25	50	4 86
UDCLRS	2005-005-010			R0.05	1	0.25	50	4 102
CBN-LRF	2005-005010	2 Flutes		R0.05	1	0.3	50	4 134
HLRS	2005-005-010			R0.05	1	0.5	50	4 318
HLRS	4005-005-010			4 Flutes	R0.05	1	0.3	50
UPDLRS	1005-005-015	1 Flutes		R0.05	1.5	0.25	40	4 316
CBN-RSF	1005-005015	2 Flutes		R0.05	1.5	0.3	50	4 127
UDCLRSF	2005-005015			R0.05	1.5	0.25	50	4 86
CBN-LRF	2005-005015	2 Flutes		R0.05	1.5	0.3	50	4 134
CBN-LRF	2005-005020			R0.05	2	0.3	50	4 134
HLRS	2005-005-020			R0.05	2	0.5	50	4 318
HLRS	4005-005-020	4 Flutes		R0.05	2	0.3	50	4 340
HLRS	2005-005-030	2 Flutes		R0.05	3	0.5	50	4 318
HLRS	2005-005-040			R0.05	4	0.5	50	4 318
HLRS	2005-005-050			R0.05	5	0.5	50	4 318
CBN-LRF	2005-010005	2 Flutes		R0.1	0.5	0.3	50	4 134
CBN-LRF	2005-010010			R0.1	1	0.3	50	4 134
HLRS	2005-01-010	4 Flutes		R0.1	1	0.5	50	4 318
HLRS	4005-01-010			R0.1	1	0.3	50	4 340
UPDLRS	1005-010-015			1 Flutes	R0.1	1.5	0.25	40
CBN-LRF	2005-010015	2 Flutes		R0.1	1.5	0.3	50	4 134
CBN-LRF	2005-010020			R0.1	2	0.3	50	4 134

Simplified Table

Radius

Model Number	Number of Flutes	Outside Diameter	Corner Radius	Effective Length	Length of Cut	Overall Length	Shank Diameter	Page
HLRS	2005-01-020	2 Flutes	0.5	R0.1	2	0.5	50	4 318
HLRS	4005-01-020	4 Flutes		R0.1	2	0.3	50	4 340
HLRS	2005-01-030	2 Flutes		R0.1	3	0.5	50	4 318
HLRS	2005-01-040			R0.1	4	0.5	50	4 318
HLRS	2005-01-050			R0.1	5	0.5	50	4 318
HLRS	2005-01-060			R0.1	6	0.5	50	4 318
CBN-LRF	2006-002005	2 Flutes	0.6	RO.02	0.5	0.3	50	4 134
CBN-RSF	1006-002010	1 Flutes		RO.02	1	0.3	50	4 127
CBN-LRF	2006-002010	2 Flutes		RO.02	1	0.3	50	4 134
CBN-RSF	1006-002015	1 Flutes		RO.02	1.5	0.3	50	4 127
CBN-LRF	2006-002015	2 Flutes		RO.02	1.5	0.3	50	4 134
CBN-LRF	2006-005005			RO.05	0.5	0.3	50	4 134
CBN-RSF	1006-005010	1 Flutes		RO.05	1	0.3	50	4 127
CBN-LRF	2006-005010	2 Flutes		RO.05	1	0.3	50	4 134
CBN-RSF	1006-005015	1 Flutes		RO.05	1.5	0.3	50	4 127
CBN-LRF	2006-005015	2 Flutes		RO.05	1.5	0.3	50	4 134
HLRS	2006-005-020			RO.05	2	0.6	50	4 320
HLRS	4006-005-020	4 Flutes		RO.05	2	0.36	50	4 340
CBN-LRF	2006-005030	2 Flutes	RO.05	3	0.3	50	4 134	
HLRS	2006-005-030		RO.05	3	0.6	50	4 320	
HLRS	2006-005-040		RO.05	4	0.6	50	4 320	
HLRS	4006-005-040		4 Flutes	RO.05	4	0.36	50	4 340
HLRS	2006-005-060	2 Flutes	RO.05	6	0.6	50	4 320	
HLRS	2006-005-080		RO.05	8	0.6	50	4 320	
CBN-LRF	2006-010005	2 Flutes	RO.1	0.5	0.3	50	4 134	
CBN-LRF	2006-010010		RO.1	1	0.3	50	4 134	
CBN-LRF	2006-010015		RO.1	1.5	0.3	50	4 134	
HLRS	2006-01-020	2 Flutes	RO.1	2	0.6	50	4 320	
HLRS	2006-01-020E		RO.1	2	0.6	50	4 320	
HLRS	4006-01-020		4 Flutes	RO.1	2	0.36	50	4 340
HLRS	2006-01-030		2 Flutes	RO.1	3	0.6	50	4 320
HLRS	2006-01-030E			RO.1	3	0.6	50	4 320
HLRS	2006-01-040			RO.1	4	0.6	50	4 320
HLRS	2006-01-040E			RO.1	4	0.6	50	4 320
HLRS	4006-01-040		4 Flutes	RO.1	4	0.36	50	4 340
HLRS	2006-01-060		2 Flutes	RO.1	6	0.6	50	4 320
HLRS	2006-01-080			RO.1	8	0.6	50	4 320
HLRS	2006-02-020			RO.2	2	0.6	50	4 320
HLRS	2006-02-030			RO.2	3	0.6	50	4 320
HLRS	2006-02-040	2 Flutes	RO.2	4	0.6	50	4 320	

Model Number	Number of Flutes	Outside Diameter	Corner Radius	Effective Length	Length of Cut	Overall Length	Shank Diameter	Page
HLRS	2006-02-060	2 Flutes	0.6	RO.2	6	0.6	50	4 320
HLRS	2006-02-080			RO.2	8	0.6	50	4 320
HLRS	2007-01-040	2 Flutes	0.7	RO.1	4	0.7	50	4 320
HLRS	2007-01-060			RO.1	6	0.7	50	4 320
HLRS	2007-02-040			RO.2	4	0.7	50	4 320
HLRS	2007-02-060			RO.2	6	0.7	50	4 320
CBN-RSF	1008-002010	1 Flutes	0.8	RO.02	1	0.56	50	4 127
CBN-LRF	2008-002010	2 Flutes		RO.02	1	0.56	50	4 134
CBN-LRF	2008-002015			RO.02	1.5	0.56	50	4 134
CBN-RSF	1008-002020	1 Flutes		RO.02	2	0.56	50	4 127
CBN-LRF	2008-002020	2 Flutes		RO.02	2	0.56	50	4 134
HLRS	4008-002-020			RO.02	2	0.48	50	4 340
HLRS	4008-002-030	4 Flutes		RO.02	3	0.48	50	4 340
HLRS	4008-002-040			RO.02	4	0.48	50	4 340
CBN-LRF	2008-002050	2 Flutes		RO.02	5	0.56	50	4 134
HLRS	4008-002-060	4 Flutes		RO.02	6	0.48	50	4 340
HLRS	4008-002-080			RO.02	8	0.48	50	4 340
UDCLRSF	2008-003008	2 Flutes		0.8	RO.03	0.8	0.4	50
UDCLRS	2008-003-008		RO.03		0.8	0.4	50	4 102
UDCLRSF	2008-003016		RO.03		1.6	0.4	50	4 86
UDCLRS	2008-003-016		RO.03		1.6	0.4	50	4 102
UDCLRSF	2008-003024		RO.03		2.4	0.4	50	4 86
UDCLRSF	2008-005008		RO.05		0.8	0.4	50	4 86
UDCLRS	2008-005-008		RO.05		0.8	0.4	50	4 102
CBN-RSF	1008-005010		1 Flutes		RO.05	1	0.56	50
CBN-LRF	2008-005010	2 Flutes	RO.05	1	0.56	50	4 134	
CBN-LRF	2008-005015		RO.05	1.5	0.56	50	4 134	
UDCLRSF	2008-005016		RO.05	1.6	0.4	50	4 86	
UDCLRS	2008-005-016		RO.05	1.6	0.4	50	4 102	
CBN-RSF	1008-005020	1 Flutes	RO.05	2	0.56	50	4 127	
CBN-LRF	2008-005020	2 Flutes	RO.05	2	0.56	50	4 134	
HLRS	4008-005-020	4 Flutes	RO.05	2	0.48	50	4 340	
UDCLRSF	2008-005024	2 Flutes	RO.05	2.4	0.4	50	4 86	
HLRS	4008-005-030	4 Flutes	RO.05	3	0.48	50	4 340	
HLRS	2008-005-040	2 Flutes	RO.05	4	0.8	50	4 320	
HLRS	4008-005-040	4 Flutes	RO.05	4	0.48	50	4 340	
CBN-LRF	2008-005050	2 Flutes	RO.05	5	0.56	50	4 134	
HLRS	2008-005-060		RO.05	6	0.8	50	4 320	
HLRS	4008-005-060	4 Flutes	RO.05	6	0.48	50	4 340	
HLRS	2008-005-080	2 Flutes	RO.05	8	0.8	50	4 320	

Simplified Table

Radius

Model Number	Number of Flutes	Outside Diameter	Corner Radius	Effective Length	Length of Cut	Overall Length	Shank Diameter	Page	Model Number	Number of Flutes	Outside Diameter	Corner Radius	Effective Length	Length of Cut	Overall Length	Shank Diameter	Page
UDCLRSF 2008-010008	2 Flutes	0.8	RO.1	0.8	0.4	50	4	86	DCLRS 4010-002-200	4 Flutes	1	RO.02	20	2	60	4	376
UDCLRS 2008-010-008			RO.1	0.8	0.4	50	4	102	UDCLRSF 2010-003010	2 Flutes		RO.03	1	0.5	50	4	88
CBN-LRF 2008-010010			RO.1	1	0.56	50	4	134	UDCLRS 2010-003-010			RO.03	1	0.5	50	4	102
CBN-LRF 2008-010015			RO.1	1.5	0.56	50	4	134	UDCLRSF 2010-003020			RO.03	2	0.5	50	4	88
UDCLRSF 2008-010016			RO.1	1.6	0.4	50	4	86	UDCLRS 2010-003-020			RO.03	2	0.5	50	4	102
UDCLRS 2008-010-016			RO.1	1.6	0.4	50	4	102	UDCLRSF 2010-003040			RO.03	4	0.5	50	4	88
CBN-LRF 2008-010020			RO.1	2	0.56	50	4	134	UDCLRSF 2010-003060			RO.03	6	0.5	50	4	88
HLRS 4008-01-020	4 Flutes	RO.1	2	0.48	50	4	340	CBN-RSF 1010-005010	1 Flutes		RO.05	1	0.7	50	4	127	
UDCLRSF 2008-010024	2 Flutes	RO.1	2.4	0.4	50	4	86	UDCLRSF 2010-005010	2 Flutes	RO.05	1	0.5	50	4	88		
HLRS 4008-01-030	4 Flutes	RO.1	3	0.48	50	4	340	UDCLRS 2010-005-010		RO.05	1	0.5	50	4	102		
HLRS 2008-01-040	2 Flutes	RO.1	4	0.8	50	4	320	CBN-LRF 2010-005010	1 Flutes	RO.05	1	0.7	50	4	135		
HLRS 4008-01-040	4 Flutes	RO.1	4	0.48	50	4	340	CBN-RSF 1010-005020		RO.05	2	0.7	50	4	127		
CBN-LRF 2008-010050	2 Flutes	RO.1	5	0.56	50	4	134	UDCLRSF 2010-005020	2 Flutes	RO.05	2	0.5	50	4	88		
HLRS 2008-01-060		RO.1	6	0.8	50	4	320	UDCLRS 2010-005-020		RO.05	2	0.5	50	4	102		
HLRS 4008-01-060	4 Flutes	RO.1	6	0.48	50	4	340	CBN-LRF 2010-005020		RO.05	2	0.7	50	4	135		
HLRS 2008-01-080	2 Flutes	RO.1	8	0.8	50	4	320	HLRS 2010-005-020		RO.05	2	1	50	4	320		
HLRS 4008-02-020	4 Flutes	RO.2	2	0.48	50	4	340	HLRS 4010-005-020	4 Flutes	RO.05	2	0.8	50	4	340		
HLRS 4008-02-030		RO.2	3	0.48	50	4	340	UPDLRS 1010-005-030	1 Flutes	RO.05	3	0.55	40	4	316		
HLRS 2008-02-040	2 Flutes	RO.2	4	0.8	50	4	320	CBN-RSF 1010-005030	2 Flutes	RO.05	3	0.7	50	4	127		
HLRS 4008-02-040	4 Flutes	RO.2	4	0.48	50	4	340	CBN-LRF 2010-005030		RO.05	3	0.7	50	4	135		
HLRS 2008-02-060	2 Flutes	RO.2	6	0.8	50	4	320	HLRS 2010-005-030	4 Flutes	RO.05	3	1	50	4	320		
HLRS 4008-02-060	4 Flutes	RO.2	6	0.48	50	4	340	HLRS 4010-005-030		RO.05	3	0.8	50	4	340		
HLRS 2008-02-080	2 Flutes	RO.2	8	0.8	50	4	320	UDCLRSF 2010-005040	2 Flutes	RO.05	4	0.5	50	4	88		
CBN-RSF 1010-002010	1 Flutes	RO.02	1	0.7	50	4	127	HLRS 2010-005-040		RO.05	4	1	50	4	320		
CBN-LRF 2010-002010	2 Flutes	RO.02	1	0.7	50	4	135	HLRS 4010-005-040	4 Flutes	RO.05	4	0.8	50	4	340		
CBN-RSF 1010-002020	1 Flutes	RO.02	2	0.7	50	4	127	CBN-LRF 2010-005050	2 Flutes	RO.05	5	0.7	50	4	135		
CBN-LRF 2010-002020	2 Flutes	RO.02	2	0.7	50	4	135	HLRS 2010-005-050		RO.05	5	1	50	4	320		
HLRS 4010-002-020	4 Flutes	RO.02	2	0.8	50	4	340	HLRS 4010-005-050	4 Flutes	RO.05	5	0.8	50	4	342		
CBN-RSF 1010-002030	1 Flutes	RO.02	3	0.7	50	4	127	UDCLRSF 2010-005060	2 Flutes	RO.05	6	0.5	50	4	88		
CBN-LRF 2010-002030	2 Flutes	RO.02	3	0.7	50	4	135	HLRS 2010-005-060		RO.05	6	1	50	4	320		
HLRS 4010-002-030	4 Flutes	RO.02	3	0.8	50	4	340	HLRS 4010-005-060	4 Flutes	RO.05	6	0.8	50	4	342		
HLRS 4010-002-040		RO.02	4	0.8	50	4	340	DCLRS 4010-005-060		RO.05	6	2	50	4	376		
CBN-LRF 2010-002050	2 Flutes	RO.02	5	0.7	50	4	135	HLRS 2010-005-080	2 Flutes	RO.05	8	1	50	4	320		
HLRS 4010-002-050	4 Flutes	RO.02	5	0.8	50	4	340	HLRS 4010-005-080	4 Flutes	RO.05	8	0.8	50	4	342		
HLRS 4010-002-060		RO.02	6	0.8	50	4	340	HLRS 2010-005-100	2 Flutes	RO.05	10	1	50	4	320		
DCLRS 4010-002-060		RO.02	6	2	50	4	376	HLRS 4010-005-100	4 Flutes	RO.05	10	0.8	50	4	342		
HLRS 4010-002-080		RO.02	8	0.8	50	4	340	DCLRS 4010-005-100	RO.05	10	2	50	4	376			
HLRS 4010-002-100		RO.02	10	0.8	50	4	340	HLRS 2010-005-120	2 Flutes	RO.05	12	1	55	4	320		
DCLRS 4010-002-100		RO.02	10	2	50	4	376	HLRS 4010-005-120	4 Flutes	RO.05	12	0.8	55	4	342		
HLRS 4010-002-120		RO.02	12	0.8	55	4	340	HLRS 2010-005-160	2 Flutes	RO.05	16	1	60	4	320		

Simplified Table

Radius

Model Number	Number of Flutes	Outside Diameter	Corner Radius	Effective Length	Length of Cut	Overall Length	Shank Diameter	Page
HLRS 2010-005-200	2 Flutes	1	R0.05	20	1	60	4	320
DCLR 4010-005-200	4 Flutes		R0.05	20	2	60	4	376
CKERS 4010-01-025	1 Flutes		R0.1	—	2.5	50	4	298
CBN-RSF 1010-010010	1 Flutes		R0.1	1	0.7	50	4	127
UDCLRSF 2010-010010	2 Flutes		R0.1	1	0.5	50	4	88
UDCLRS 2010-010-010	2 Flutes		R0.1	1	0.5	50	4	102
CBN-LRF 2010-010010	1 Flutes		R0.1	1	0.7	50	4	135
CBN-RSF 1010-010020	1 Flutes		R0.1	2	0.7	50	4	127
UDCLRSF 2010-010020	2 Flutes		R0.1	2	0.5	50	4	88
UDCLRS 2010-010-020	2 Flutes		R0.1	2	0.5	50	4	102
CBN-LRF 2010-010020	2 Flutes		R0.1	2	0.7	50	4	135
HLRS 2010-01-020	2 Flutes		R0.1	2	1	50	4	320
HLRS 2010-01-020E	2 Flutes		R0.1	2	1	50	4	320
HLRS 4010-01-020	4 Flutes		R0.1	2	0.8	50	4	342
UPDLRS 1010-010-030	1 Flutes		R0.1	3	0.55	40	4	316
CBN-RSF 1010-010030	2 Flutes		R0.1	3	0.7	50	4	127
CBN-LRF 2010-010030	2 Flutes		R0.1	3	0.7	50	4	135
HLRS 2010-01-030	4 Flutes		R0.1	3	1	50	4	320
HLRS 4010-01-030	4 Flutes		R0.1	3	0.8	50	4	342
UDCLRSF 2010-010040	2 Flutes		R0.1	4	0.5	50	4	88
HLRS 2010-01-040	2 Flutes		R0.1	4	1	50	4	320
HLRS 2010-01-040E	2 Flutes		R0.1	4	1	50	4	320
HLRS 4010-01-040	4 Flutes		R0.1	4	0.8	50	4	342
CBN-LRF 2010-010050	2 Flutes		R0.1	5	0.7	50	4	135
HLRS 2010-01-050	4 Flutes		R0.1	5	1	50	4	320
HLRS 4010-01-050	4 Flutes		R0.1	5	0.8	50	4	342
UDCLRSF 2010-010060	2 Flutes		R0.1	6	0.5	50	4	88
HLRS 2010-01-060	2 Flutes		R0.1	6	1	50	4	320
HLRS 2010-01-060E	2 Flutes		R0.1	6	1	50	4	320
HLRS 4010-01-060	4 Flutes		R0.1	6	0.8	50	4	342
HLRS 2010-01-080	2 Flutes		R0.1	8	1	50	4	322
HLRS 4010-01-080	4 Flutes		R0.1	8	0.8	50	4	342
HLRS 2010-01-100	2 Flutes		R0.1	10	1	50	4	322
HLRS 4010-01-100	4 Flutes		R0.1	10	0.8	50	4	342
HLRS 2010-01-120	2 Flutes		R0.1	12	1	55	4	322
HLRS 4010-01-120	4 Flutes		R0.1	12	0.8	55	4	342
HLRS 2010-01-160	2 Flutes		R0.1	16	1	60	4	322
HLRS 2010-01-200	2 Flutes		R0.1	20	1	60	4	322
C-CRS 2010-02	4 Flutes		R0.2	—	2	45	4	290
CKERS 4010-02-025	4 Flutes		R0.2	—	2.5	50	4	298

Model Number	Number of Flutes	Outside Diameter	Corner Radius	Effective Length	Length of Cut	Overall Length	Shank Diameter	Page
CBN-LRF 2010-020010	2 Flutes	1	R0.2	1	0.7	50	4	135
CBN-LRF 2010-020020			R0.2	2	0.7	50	4	135
HLRS 2010-02-020			R0.2	2	1	50	4	322
HLRS 2010-02-020E	R0.2		2	1	50	4	322	
HLRS 4010-02-020	4 Flutes		R0.2	2	0.8	50	4	342
UPDLRS 1010-020-030	1 Flutes		R0.2	3	0.55	40	4	316
HLRS 2010-02-030	2 Flutes		R0.2	3	1	50	4	322
HLRS 4010-02-030	4 Flutes		R0.2	3	0.8	50	4	342
HLRS 2010-02-040	2 Flutes		R0.2	4	1	50	4	322
HLRS 2010-02-040E			R0.2	4	1	50	4	322
HLRS 4010-02-040	4 Flutes		R0.2	4	0.8	50	4	342
HLRS 2010-02-050	2 Flutes		R0.2	5	1	50	4	322
HLRS 4010-02-050	4 Flutes		R0.2	5	0.8	50	4	342
HLRS 2010-02-060	2 Flutes		R0.2	6	1	50	4	322
HLRS 2010-02-060E			R0.2	6	1	50	4	322
HLRS 4010-02-060	4 Flutes		R0.2	6	0.8	50	4	342
HLRS 2010-02-080	2 Flutes		R0.2	8	1	50	4	322
HLRS 4010-02-080	4 Flutes		R0.2	8	0.8	50	4	342
HLRS 2010-02-100	2 Flutes		R0.2	10	1	50	4	322
HLRS 4010-02-100	4 Flutes		R0.2	10	0.8	50	4	342
HLRS 2010-02-120	2 Flutes		R0.2	12	1	55	4	322
HLRS 4010-02-120	4 Flutes		R0.2	12	0.8	55	4	342
HLRS 2010-02-160	2 Flutes		R0.2	16	1	60	4	322
HLRS 2010-02-200			R0.2	20	1	60	4	322
C-CRS 2010-03	4 Flutes		R0.3	—	2	45	4	290
CKERS 4010-03-025	4 Flutes		R0.3	—	2.5	50	4	298
HLRS 2010-03-020	2 Flutes		R0.3	2	1	50	4	322
HLRS 2010-03-020E			R0.3	2	1	50	4	322
HLRS 4010-03-020	4 Flutes		R0.3	2	0.8	50	4	342
HLRS 2010-03-030	2 Flutes		R0.3	3	1	50	4	322
HLRS 4010-03-030	4 Flutes		R0.3	3	0.8	50	4	342
HLRS 2010-03-040	2 Flutes		R0.3	4	1	50	4	322
HLRS 2010-03-040E			R0.3	4	1	50	4	322
HLRS 4010-03-040	4 Flutes		R0.3	4	0.8	50	4	342
HLRS 2010-03-050	2 Flutes		R0.3	5	1	50	4	322
HLRS 4010-03-050	4 Flutes		R0.3	5	0.8	50	4	342
HLRS 2010-03-060	2 Flutes		R0.3	6	1	50	4	322
HLRS 2010-03-060E			R0.3	6	1	50	4	322
HLRS 4010-03-060	4 Flutes		R0.3	6	0.8	50	4	342
HLRS 2010-03-080	2 Flutes		R0.3	8	1	50	4	322

Simplified Table

Radius									
Model Number	Number of Flutes	Outside Diameter	Corner Radius	Effective Length	Length of Cut	Overall Length	Shank Diameter	Page	
HLRS	4010-03-080	4 Flutes	1	RO.3	8	0.8	50	4 342	
HLRS	2010-03-100	2 Flutes		RO.3	10	1	50	4 322	
HLRS	4010-03-100	4 Flutes		RO.3	10	0.8	50	4 342	
HLRS	2010-03-120	2 Flutes		RO.3	12	1	55	4 322	
HLRS	4010-03-120	4 Flutes		RO.3	12	0.8	55	4 342	
HLRS	2010-03-160	2 Flutes		RO.3	16	1	60	4 322	
HLRS	4010-03-160	4 Flutes		RO.3	16	0.8	60	4 342	
HLRS	2010-03-200	2 Flutes		RO.3	20	1	60	4 322	
HLRS	4012-01-040	4 Flutes		1.2	RO.1	4	0.96	50	4 342
HLRS	4012-01-060				RO.1	6	0.96	50	4 342
HLRS	4012-01-100		RO.1		10	0.96	50	4 342	
HLRS	4012-02-040		RO.2		4	0.96	50	4 342	
HLRS	2012-02-060	2 Flutes	RO.2		6	1.2	50	4 322	
HLRS	4012-02-060	4 Flutes	RO.2		6	0.96	50	4 342	
HLRS	4012-02-100		RO.2		10	0.96	50	4 342	
HLRS	2012-02-120	2 Flutes	RO.2		12	1.2	55	4 322	
HLRS	2012-02-200	2 Flutes	RO.2		20	1.2	60	4 322	
HLRS	4012-03-040	4 Flutes	RO.3		4	0.96	50	4 342	
HLRS	2012-03-060	2 Flutes	RO.3	6	1.2	50	4 322		
HLRS	4012-03-060	4 Flutes	RO.3	6	0.96	50	4 342		
HLRS	4012-03-100		RO.3	10	0.96	50	4 342		
HLRS	2012-03-120	2 Flutes	RO.3	12	1.2	55	4 322		
HLRS	2012-03-200	2 Flutes	RO.3	20	1.2	60	4 322		
CBN-RSF	1015-002030	1 Flutes	1.5	RO.02	3	1	50	4 127	
CBN-LRF	2015-002030	2 Flutes		RO.02	3	1	50	4 135	
CBN-LRF	2015-002040			RO.02	4	1	50	4 135	
CBN-LRF	2015-002060	RO.02		6	1	50	4 135		
DCLRS	4015-002-120	4 Flutes		RO.02	12	3	55	4 376	
DCLRS	4015-002-200			RO.02	20	3	60	4 376	
DCLRS	4015-002-300			RO.02	30	3	80	4 376	
UDCLRSF	2015-003015	2 Flutes		RO.03	1.5	0.75	50	4 88	
UDCLRS	2015-003-015			RO.03	1.5	0.75	50	4 102	
UDCLRSF	2015-003030			RO.03	3	0.75	50	4 88	
UDCLRS	2015-003-030		RO.03	3	0.75	50	4 102		
UDCLRSF	2015-005015		RO.05	1.5	0.75	50	4 88		
UDCLRS	2015-005-015		RO.05	1.5	0.75	50	4 102		
CBN-RSF	1015-005030		1 Flutes	RO.05	3	1	50	4 127	
UDCLRSF	2015-005030		2 Flutes	RO.05	3	0.75	50	4 88	
UDCLRS	2015-005-030			RO.05	3	0.75	50	4 102	
CBN-LRF	2015-005030			RO.05	3	1	50	4 135	
HLRS	4015-005-030	4 Flutes	1.5	RO.05	3	1.2	50	4 344	
CBN-LRF	2015-005040	2 Flutes		RO.05	4	1	50	4 135	
HLRS	2015-005-040	4 Flutes		RO.05	4	1.5	50	4 322	
HLRS	4015-005-040	4 Flutes		RO.05	4	1.2	50	4 344	
CBN-LRF	2015-005060	2 Flutes		RO.05	6	1	50	4 135	
HLRS	2015-005-060	4 Flutes		RO.05	6	1.5	50	4 322	
HLRS	4015-005-060	4 Flutes		RO.05	6	1.2	50	4 344	
HLRS	2015-005-080	2 Flutes		RO.05	8	1.5	50	4 322	
HLRS	4015-005-080	4 Flutes		RO.05	8	1.2	50	4 344	
HLRS	2015-005-100	2 Flutes		RO.05	10	1.5	50	4 322	
HLRS	4015-005-100	4 Flutes	RO.05	10	1.2	50	4 344		
HLRS	2015-005-120	2 Flutes	RO.05	12	1.5	55	4 322		
HLRS	4015-005-120	4 Flutes	RO.05	12	1.2	55	4 344		
HLRS	2015-005-160	2 Flutes	RO.05	16	1.5	55	4 322		
HLRS	4015-005-160	4 Flutes	RO.05	16	1.2	60	4 344		
HLRS	4015-005-180	4 Flutes	RO.05	18	1.2	60	4 344		

Simplified Table

Radius

Model Number	Number of Flutes	Outside Diameter	Corner Radius	Effective Length	Length of Cut	Overall Length	Shank Diameter	Page
HLRS 2015-01-200	2 Flutes	1.5	R0.1	20	1.5	60	4	322
C-CRS 2015-02			RO.2	—	3	45	4	290
CXERS 4015-02-0375	4 Flutes		RO.2	—	3.75	50	4	298
HLRS 4015-02-030			RO.2	3	1.2	50	4	344
HLRS 2015-02-040	2 Flutes		RO.2	4	1.5	50	4	324
HLRS 4015-02-040	4 Flutes		RO.2	4	1.2	50	4	344
HLRS 2015-02-060	2 Flutes		RO.2	6	1.5	50	4	324
HLRS 4015-02-060	4 Flutes		RO.2	6	1.2	50	4	344
HLRS 2015-02-080	2 Flutes		RO.2	8	1.5	50	4	324
HLRS 4015-02-080	4 Flutes		RO.2	8	1.2	50	4	344
HLRS 2015-02-100	2 Flutes		RO.2	10	1.5	50	4	324
HLRS 4015-02-100	4 Flutes		RO.2	10	1.2	50	4	344
HLRS 2015-02-120	2 Flutes		RO.2	12	1.5	55	4	324
HLRS 4015-02-120	4 Flutes		RO.2	12	1.2	55	4	344
HLRS 2015-02-160	2 Flutes		RO.2	16	1.5	55	4	324
HLRS 4015-02-160	4 Flutes		RO.2	16	1.2	60	4	344
HLRS 4015-02-180			RO.2	18	1.2	60	4	344
HLRS 2015-02-200	2 Flutes		RO.2	20	1.5	60	4	324
C-CRS 2015-03			RO.3	—	3	45	4	290
CXERS 4015-03-0375	4 Flutes		RO.3	—	3.75	50	4	298
HLRS 4015-03-030		RO.3	3	1.2	50	4	344	
HLRS 2015-03-040	2 Flutes	RO.3	4	1.5	50	4	324	
HLRS 4015-03-040	4 Flutes	RO.3	4	1.2	50	4	344	
CBN-LRF 2015-030045	2 Flutes	RO.3	4.5	1	50	4	135	
HLRS 2015-03-060		RO.3	6	1.5	50	4	324	
HLRS 4015-03-060	4 Flutes	RO.3	6	1.2	50	4	344	
HLRS 2015-03-080	2 Flutes	RO.3	8	1.5	50	4	324	
HLRS 4015-03-080	4 Flutes	RO.3	8	1.2	50	4	344	
HLRS 2015-03-100	2 Flutes	RO.3	10	1.5	50	4	324	
HLRS 4015-03-100	4 Flutes	RO.3	10	1.2	50	4	344	
HLRS 2015-03-120	2 Flutes	RO.3	12	1.5	55	4	324	
HLRS 4015-03-120	4 Flutes	RO.3	12	1.2	55	4	344	
HLRS 2015-03-160	2 Flutes	RO.3	16	1.5	55	4	324	
HLRS 4015-03-160	4 Flutes	RO.3	16	1.2	60	4	344	
HLRS 4015-03-180		RO.3	18	1.2	60	4	344	
HLRS 2015-03-200	2 Flutes	RO.3	20	1.5	60	4	324	
C-CRS 2015-05		RO.5	—	3	45	4	290	
HLRS 4015-05-030	4 Flutes	RO.5	3	1.2	50	4	344	
HLRS 2015-05-040	2 Flutes	RO.5	4	1.5	50	4	324	
HLRS 4015-05-040	4 Flutes	RO.5	4	1.2	50	4	344	

Model Number	Number of Flutes	Outside Diameter	Corner Radius	Effective Length	Length of Cut	Overall Length	Shank Diameter	Page	
HLRS 2015-05-060	2 Flutes	1.5	R0.5	6	1.5	50	4	324	
HLRS 4015-05-060	4 Flutes		RO.5	6	1.2	50	4	344	
HLRS 2015-05-080	2 Flutes		RO.5	8	1.5	50	4	324	
HLRS 4015-05-080	4 Flutes		RO.5	8	1.2	50	4	344	
HLRS 2015-05-100	2 Flutes		RO.5	10	1.5	50	4	324	
HLRS 4015-05-100	4 Flutes		RO.5	10	1.2	50	4	344	
HLRS 2015-05-120	2 Flutes		RO.5	12	1.5	55	4	324	
HLRS 4015-05-120	4 Flutes		RO.5	12	1.2	55	4	344	
HLRS 2015-05-160	2 Flutes		RO.5	16	1.5	55	4	324	
HLRS 4015-05-160	4 Flutes		RO.5	16	1.2	60	4	344	
HLRS 4015-05-180			RO.5	18	1.2	60	4	344	
HLRS 2015-05-200	2 Flutes		RO.5	20	1.5	60	4	324	
HLRS 4018-02-080	4 Flutes		1.8	RO.2	8	1.44	50	4	346
HLRS 4018-02-100				RO.2	10	1.44	50	4	346
HLRS 4018-02-120				RO.2	12	1.44	55	4	346
HLRS 4018-02-140				RO.2	14	1.44	55	4	346
HLRS 4018-02-160	4 Flutes	RO.2	16	1.44	60	4	346		
CBN-RSF 1020-002040	1 Flutes	2	RO.02	4	1.2	50	4	127	
CBN-LRF 2020-002040	2 Flutes		RO.02	4	1.2	50	4	135	
HLRS 4020-002-040	4 Flutes		RO.02	4	1.6	50	4	346	
CBN-RSF 1020-002060	1 Flutes		RO.02	6	1.2	50	4	127	
CBN-LRF 2020-002060	2 Flutes		RO.02	6	1.2	50	4	135	
HLRS 4020-002-060	4 Flutes		RO.02	6	1.6	50	4	346	
CBN-LRF 2020-002080	2 Flutes		RO.02	8	1.2	50	4	135	
HLRS 4020-002-080	4 Flutes		RO.02	8	1.6	50	4	346	
CBN-LRF 2020-002100	2 Flutes		RO.02	10	1.2	50	4	135	
HLRS 4020-002-100	4 Flutes		RO.02	10	1.6	50	4	346	
HLRS 4020-002-120			RO.02	12	1.6	55	4	346	
HLRS 4020-002-160			RO.02	16	1.6	60	4	346	
HLRS 4020-002-200			RO.02	20	1.6	60	4	346	
UDCLRSF 2020-003020	2 Flutes		RO.03	2	1	50	4	88	
UDCLRS 2020-003-020			RO.03	2	1	50	4	102	
CBN-LRF 2020-003030			RO.03	3	1.2	50	4	135	
UDCLRSF 2020-003040		RO.03	4	1	50	4	88		
UDCLRS 2020-003-040		RO.03	4	1	50	4	102		
UDCLRSF 2020-003060		RO.03	6	1	50	4	88		
UDCLRSF 2020-003080		RO.03	8	1	50	4	88		
UDCLRSF 2020-003100		RO.03	10	1	50	4	88		
UDCLRSF 2020-005020		RO.05	2	1	50	4	88		
UDCLRS 2020-005-020		RO.05	2	1	50	4	102		

Simplified Table

Radius								
Model Number	Number of Flutes	Outside Diameter	Corner Radius	Effective Length	Length of Cut	Overall Length	Shank Diameter	Page
UPDLRS	1020-005-040	1 Flutes	RO.05	4	0.55	40	4	316
CBN-RSF	1020-005040		RO.05	4	1.2	50	4	127
UDCLRSF	2020-005040	2 Flutes	RO.05	4	1	50	4	88
UDCLRS	2020-005-040		RO.05	4	1	50	4	102
CBN-LRF	2020-005040		RO.05	4	1.2	50	4	135
HLRS	2020-005-040		RO.05	4	2	50	4	324
HLRS	4020-005-040	4 Flutes	RO.05	4	1.6	50	4	346
CBN-RSF	1020-005060	1 Flutes	RO.05	6	1.2	50	4	127
UDCLRSF	2020-005060	2 Flutes	RO.05	6	1	50	4	88
CBN-LRF	2020-005060		RO.05	6	1.2	50	4	135
HLRS	2020-005-060	RO.05	6	2	50	4	324	
HLRS	4020-005-060	4 Flutes	RO.05	6	1.6	50	4	346
CBN-LRF	2020-005080	2 Flutes	RO.05	8	1.2	50	4	135
UDCLRSF	2020-005080		RO.05	8	1	50	4	88
HLRS	2020-005-080	RO.05	8	2	50	4	324	
HLRS	4020-005-080	4 Flutes	RO.05	8	1.6	50	4	346
UDCLRSF	2020-005100	2 Flutes	RO.05	10	1	50	4	88
CBN-LRF	2020-005100		RO.05	10	1.2	50	4	135
HLRS	2020-005-100	RO.05	10	2	50	4	324	
HLRS	4020-005-100	2	RO.05	10	1.6	50	4	346
DCLRS	4020-005-100	4 Flutes	RO.05	10	4	50	4	377
HLRS	4020-005-120		RO.05	12	1.6	55	4	346
HLRS	4020-005-160	RO.05	16	1.6	60	4	346	
HLRS	4020-005-200	RO.05	20	1.6	60	4	346	
DCLRS	4020-005-200	2 Flutes	RO.05	20	4	60	4	377
CXERS	4020-01-050		RO.1	—	5	50	4	298
UDCLRSF	2020-010020	2 Flutes	RO.1	2	1	50	4	88
UDCLRS	2020-010-020		RO.1	2	1	50	4	102
UPDLRS	1020-010-040	1 Flutes	RO.1	4	0.55	40	4	316
CBN-RSF	1020-010040		RO.1	4	1.2	50	4	127
UDCLRSF	2020-010040	2 Flutes	RO.1	4	1	50	4	88
UDCLRS	2020-010-040		RO.1	4	1	50	4	102
CBN-LRF	2020-010040		RO.1	4	1.2	50	4	135
HLRS	2020-01-040		RO.1	4	2	50	4	324
HLRS	2020-01-040E	4 Flutes	RO.1	4	2	50	4	324
HLRS	4020-01-040		RO.1	4	1.6	50	4	346
CBN-RSF	1020-010060	1 Flutes	RO.1	6	1.2	50	4	127
CPRS25NSP	2020-010-06	2 Flutes	RO.1	6	3	38	3	564
UDCLRSF	2020-010060		RO.1	6	1	50	4	88
CBN-LRF	2020-010060	RO.1	6	1.2	50	4	135	
HLRS	2020-01-060	2 Flutes	RO.1	6	2	50	4	324
HLRS	2020-01-060E		RO.1	6	2	50	4	324
CRS40HSP	3020-020-06	3 Flutes	RO.2	6	3	38	3	568
HLRS	4020-02-060	4 Flutes	RO.2	6	1.6	50	4	346
CBN-LRF	2020-020080	2 Flutes	RO.2	8	1.2	50	4	135
HLRS	2020-02-080		RO.2	8	2	50	4	324
HLRS	2020-02-080E	4 Flutes	RO.2	8	2	50	4	324
HLRS	4020-02-080		RO.2	8	1.6	50	4	346
HLRS	2020-01-060	2 Flutes	RO.1	6	2	50	4	324
HLRS	2020-01-060E		RO.1	6	2	50	4	324
UDCLRSF	2020-010100	2 Flutes	RO.1	10	1	50	4	88
CBN-LRF	2020-010100		RO.1	10	1.2	50	4	135
HLRS	2020-01-100	RO.1	10	2	50	4	324	
HLRS	2020-01-100E	4 Flutes	RO.1	10	2	50	4	324
HLRS	4020-01-100		RO.1	10	1.6	50	4	346
HLRS	2020-01-120	2 Flutes	RO.1	12	2	55	4	324
HLRS	2020-01-120E		RO.1	12	2	55	4	324
HLRS	4020-01-120	4 Flutes	RO.1	12	1.6	55	4	346
HLRS	2020-01-160	2 Flutes	RO.1	16	2	60	4	324
HLRS	4020-01-160	4 Flutes	RO.1	16	1.6	60	4	346
HLRS	2020-01-200	2 Flutes	RO.1	20	2	60	4	324
HLRS	4020-01-200	4 Flutes	RO.1	20	1.6	60	4	346
HLRS	4020-01-240	2 Flutes	RO.1	24	1.6	70	4	346
HLRS	2020-01-260		RO.1	26	2	70	4	324
HLRS	2020-01-300	RO.1	30	2	70	4	324	
C-CRS	2020-02	RO.2	—	4	45	4	290	
CXERS	4020-02-050	4 Flutes	RO.2	—	5	50	4	298
UPDLRS	1020-020-040	1 Flutes	RO.2	4	0.55	40	4	316
CBN-LRF	2020-020040	2 Flutes	RO.2	4	1.2	50	4	135
HLRS	2020-02-040		RO.2	4	2	50	4	324
HLRS	2020-02-040E	4 Flutes	RO.2	4	2	50	4	324
HLRS	4020-02-040		RO.2	4	1.6	50	4	346
CRS20HSP	4020-020-05	RO.2	5	2.5	50	6	570	
CBN-LRF	2020-020060	2 Flutes	RO.2	6	1.2	50	4	135
HLRS	2020-02-060		RO.2	6	2	50	4	324
HLRS	2020-02-060E	3 Flutes	RO.2	6	2	50	4	324
CRS40HSP	3020-020-06		RO.2	6	3	38	3	568
HLRS	4020-02-060	4 Flutes	RO.2	6	1.6	50	4	346
CBN-LRF	2020-020080	2 Flutes	RO.2	8	1.2	50	4	135
HLRS	2020-02-080		RO.2	8	2	50	4	324
HLRS	2020-02-080E	4 Flutes	RO.2	8	2	50	4	324
HLRS	4020-02-080		RO.2	8	1.6	50	4	346

Simplified Table

Radius

Model Number	Number of Flutes	Outside Diameter	Corner Radius	Effective Length	Length of Cut	Overall Length	Shank Diameter	Page
CBN-LRF 2020-020100	2 Flutes	2	R0.2	10	1.2	50	4	135
HLRS 2020-02-100			R0.2	10	2	50	4	324
HLRS 2020-02-100E			R0.2	10	2	50	4	324
CRS40HSP 3020-020-10	3 Flutes		R0.2	10	3	60	3	568
HLRS 4020-02-100	4 Flutes		R0.2	10	1.6	50	4	346
DCRS 4020-02-100			R0.2	10	4	50	4	377
HLRS 2020-02-120	2 Flutes		R0.2	12	2	55	4	326
HLRS 2020-02-120E			R0.2	12	2	55	4	326
HLRS 4020-02-120	4 Flutes		R0.2	12	1.6	55	4	346
HLRS 2020-02-160	2 Flutes		R0.2	16	2	60	4	326
HLRS 4020-02-160	4 Flutes		R0.2	16	1.6	60	4	346
HLRS 2020-02-200	2 Flutes		R0.2	20	2	60	4	326
HLRS 4020-02-200	4 Flutes		R0.2	20	1.6	60	4	346
DCRS 4020-02-200			R0.2	20	4	60	4	377
HLRS 4020-02-240	2 Flutes		R0.2	24	1.6	70	4	346
HLRS 2020-02-260			R0.2	26	2	70	4	326
HLRS 2020-02-300	4 Flutes		R0.2	30	2	70	4	326
DCRS 4020-02-300			R0.2	30	4	80	4	377
C-CRS 2020-03	2 Flutes		R0.3	—	4	45	4	290
CXERS 4020-03-050	4 Flutes		R0.3	—	5	50	4	298
HLRS 2020-03-040	2 Flutes		R0.3	4	2	50	4	326
HLRS 2020-03-040E			R0.3	4	2	50	4	326
HLRS 4020-03-040	4 Flutes		R0.3	4	1.6	50	4	346
HLRS 2020-03-060	2 Flutes		R0.3	6	2	50	4	326
HLRS 2020-03-060E			R0.3	6	2	50	4	326
HRRS 4020-03-06S	4 Flutes		R0.3	6	2	45	4	368
HLRS 4020-03-060			R0.3	6	1.6	50	4	346
HRRS 4020-03-06	2 Flutes		R0.3	6	2	70	4	362
HLRS 2020-03-080			R0.3	8	2	50	4	326
HLRS 2020-03-080E	4 Flutes		R0.3	8	2	50	4	326
HLRS 4020-03-080			R0.3	8	1.6	50	4	346
HLRS 2020-03-100	2 Flutes		R0.3	10	2	50	4	326
HLRS 2020-03-100E		R0.3	10	2	50	4	326	
HLRS 4020-03-100	4 Flutes	R0.3	10	1.6	50	4	346	
HLRS 2020-03-120	2 Flutes	R0.3	12	2	55	4	326	
HLRS 2020-03-120E		R0.3	12	2	55	4	326	
HLRS 4020-03-120	4 Flutes	R0.3	12	1.6	55	4	346	
HLRS 2020-03-160	2 Flutes	R0.3	16	2	60	4	326	
HLRS 4020-03-160	4 Flutes	R0.3	16	1.6	60	4	346	
HLRS 2020-03-200	2 Flutes	R0.3	20	2	60	4	326	

Model Number	Number of Flutes	Outside Diameter	Corner Radius	Effective Length	Length of Cut	Overall Length	Shank Diameter	Page
HLRS 4020-03-200	4 Flutes	2	R0.3	20	1.6	60	4	346
HLRS 4020-03-240			R0.3	24	1.6	70	4	346
HLRS 2020-03-260	2 Flutes		R0.3	26	2	70	4	326
HLRS 2020-03-300			R0.3	30	2	70	4	326
C-CRS 2020-05	4 Flutes		R0.5	—	4	45	4	290
CXERS 4020-05-050			R0.5	—	5	50	4	298
CBN-LRF 2020-050040	2 Flutes		R0.5	4	1.2	50	4	135
HLRS 2020-05-040			R0.5	4	2	50	4	326
HLRS 2020-05-040E	4 Flutes		R0.5	4	2	50	4	326
HLRS 4020-05-040			R0.5	4	1.6	50	4	348
CBN-LRF 2020-050060	2 Flutes		R0.5	6	1.2	50	4	135
HLRS 2020-05-060			R0.5	6	2	50	4	326
HLRS 2020-05-060E	4 Flutes		R0.5	6	2	50	4	326
HRRS 4020-05-06S			R0.5	6	2	45	4	368
HLRS 4020-05-060	2 Flutes		R0.5	6	1.6	50	4	348
HRRS 4020-05-06			R0.5	6	2	70	4	362
CRRS 4020-05-06	4 Flutes		R0.5	6	2	70	4	370
CBN-LRF 2020-050080			R0.5	8	1.2	50	4	135
HLRS 2020-05-080	2 Flutes		R0.5	8	2	50	4	326
HLRS 2020-05-080E			R0.5	8	2	50	4	326
HLRS 4020-05-080	4 Flutes		R0.5	8	1.6	50	4	348
CBN-LRF 2020-050100			R0.5	10	1.2	50	4	135
HLRS 2020-05-100	2 Flutes		R0.5	10	2	50	4	326
HLRS 2020-05-100E			R0.5	10	2	50	4	326
HLRS 4020-05-100	4 Flutes		R0.5	10	1.6	50	4	348
DCRS 4020-05-100			R0.5	10	4	50	4	377
HLRS 2020-05-120	2 Flutes		R0.5	12	2	55	4	326
HLRS 2020-05-120E			R0.5	12	2	55	4	326
HLRS 4020-05-120	4 Flutes		R0.5	12	1.6	55	4	348
HLRS 2020-05-160	2 Flutes		R0.5	16	2	60	4	326
HLRS 4020-05-160	4 Flutes		R0.5	16	1.6	60	4	348
HLRS 2020-05-200	2 Flutes		R0.5	20	2	60	4	326
HLRS 4020-05-200		R0.5	20	1.6	60	4	348	
DCRS 4020-05-200	4 Flutes	R0.5	20	4	60	4	377	
HLRS 4020-05-240		R0.5	24	1.6	70	4	348	
HLRS 2020-05-260	2 Flutes	R0.5	26	2	70	4	326	
HLRS 4020-05-260	4 Flutes	R0.5	26	1.6	70	4	348	
HLRS 2020-05-300	2 Flutes	R0.5	30	2	70	4	326	
DCRS 4020-05-300		R0.5	30	4	80	4	377	
HLRS 4020-05-300	4 Flutes	R0.5	30	1.6	70	4	348	

Simplified Table

Radius								
Model Number	Number of Flutes	Outside Diameter	Corner Radius	Effective Length	Length of Cut	Overall Length	Shank Diameter	Page
HLRS 4025-01-060	4 Flutes	2.5	RO.1	6	2	50	4	348
HLRS 4025-01-080			RO.1	8	2	50	4	348
HLRS 2025-01-100	2 Flutes		RO.1	10	2.5	50	4	326
HLRS 4025-01-100	4 Flutes		RO.1	10	2	50	4	348
HLRS 4025-01-160			RO.1	16	2	60	4	348
HLRS 2025-01-200	2 Flutes		RO.1	20	2.5	60	4	326
HLRS 4025-01-200	4 Flutes		RO.1	20	2	60	4	348
HLRS 2025-01-300	2 Flutes		RO.1	30	2.5	70	4	326
HLRS 4025-01-300	4 Flutes		RO.1	30	2	70	4	348
C-CRS 2025-02	2 Flutes		RO.2	—	5	45	4	290
CRS40HSP 3025-02-06	3 Flutes		RO.2	6	4	38	3	568
HLRS 4025-02-060	4 Flutes		RO.2	6	2	50	4	348
HLRS 4025-02-080			RO.2	8	2	50	4	348
HLRS 2025-02-100	2 Flutes		RO.2	10	2.5	50	4	326
HLRS 4025-02-100	4 Flutes		RO.2	10	2	50	4	348
HLRS 4025-02-160			RO.2	16	2	60	4	348
HLRS 2025-02-200	2 Flutes		RO.2	20	2.5	60	4	326
HLRS 4025-02-200	4 Flutes		RO.2	20	2	60	4	348
HLRS 2025-02-300	2 Flutes		RO.2	30	2.5	70	4	326
HLRS 4025-02-300	4 Flutes		RO.2	30	2	70	4	348
CRS20HSP 4025-025-06			RO.25	6	3	50	6	570
C-CRS 2025-03	2 Flutes		RO.3	—	5	45	4	290
CXERS 4025-03-0625	4 Flutes		RO.3	—	6.25	50	4	298
HLRS 4025-03-060			RO.3	6	2	50	4	348
HLRS 4025-03-080	2 Flutes	RO.3	8	2	50	4	348	
HLRS 2025-03-100		RO.3	10	2.5	50	4	326	
HLRS 4025-03-100	4 Flutes	RO.3	10	2	50	4	348	
HLRS 4025-03-160		RO.3	16	2	60	4	348	
HLRS 2025-03-200	2 Flutes	RO.3	20	2.5	60	4	326	
HLRS 4025-03-200	4 Flutes	RO.3	20	2	60	4	348	
HLRS 2025-03-300	2 Flutes	RO.3	30	2.5	70	4	326	
HLRS 4025-03-300	4 Flutes	RO.3	30	2	70	4	348	
C-CRS 2025-05	2 Flutes	RO.5	—	5	45	4	290	
CXERS 4025-05-0625	4 Flutes	RO.5	—	6.25	50	4	298	
HLRS 4025-05-060		RO.5	6	2	50	4	348	
HLRS 4025-05-080	2 Flutes	RO.5	8	2	50	4	348	
HLRS 2025-05-100		RO.5	10	2.5	50	4	326	
HLRS 4025-05-100	4 Flutes	RO.5	10	2	50	4	348	
HLRS 4025-05-160		RO.5	16	2	60	4	348	
HLRS 2025-05-200	2 Flutes	RO.5	20	2.5	60	4	326	
HLRS 4025-05-200	4 Flutes	RO.5	20	2	60	4	348	
HLRS 4025-05-300		RO.5	30	2	70	4	348	

Model Number	Number of Flutes	Outside Diameter	Corner Radius	Effective Length	Length of Cut	Overall Length	Shank Diameter	Page
HLRS 4025-05-200	4 Flutes	2.5	RO.5	20	2	60	4	348
HLRS 2025-05-300	2 Flutes		RO.5	30	2.5	70	4	326
HLRS 4025-05-300	4 Flutes	RO.5	30	2	70	4	348	
HLRS 4030-005-040	4 Flutes	3	RO.05	4	2.4	55	6	350
HLRS 4030-005-060			RO.05	6	2.4	55	6	350
HLRS 4030-005-080			RO.05	8	2.4	55	6	350
HLRS 4030-005-100			RO.05	10	2.4	55	6	350
HLRS 4030-005-120			RO.05	12	2.4	55	6	350
HLRS 4030-005-160			RO.05	16	2.4	60	6	350
DCLRS 4030-005-160			RO.05	16	6	60	4	377
HLRS 4030-005-200			RO.05	20	2.4	60	6	350
DCLRS 4030-005-200			RO.05	20	6	60	4	377
DCLRS 4030-005-300			RO.05	30	6	80	4	377
HMERS 4030-01-075			RO.1	—	7.5	60	6	312
HLRS 4030-01-040			RO.1	4	2.4	55	6	350
HLRS 2030-01-060	2 Flutes	RO.1	6	3	55	6	328	
HLRS 2030-01-060E		RO.1	6	3	55	6	328	
HLRS 4030-01-060	4 Flutes	RO.1	6	2.4	55	6	350	
CRS40HSP 3030-010-07	3 Flutes	RO.1	7	4	38	3	568	
CPRS25HSP 2030-010-08	2 Flutes	RO.1	8	4	38	3	564	
HLRS 4030-01-080	4 Flutes	RO.1	8	2.4	55	6	350	
HLRS 4030-01-100		RO.1	10	2.4	55	6	350	
HLRS 2030-01-120	2 Flutes	RO.1	12	3	55	6	328	
HLRS 4030-01-120	4 Flutes	RO.1	12	2.4	55	6	350	
HLRS 2030-01-160	2 Flutes	RO.1	16	3	60	6	328	
HLRS 2030-01-160E		RO.1	16	3	60	6	328	
HLRS 4030-01-160	4 Flutes	RO.1	16	2.4	60	6	350	
HLRS 2030-01-180	2 Flutes	RO.1	18	3	60	6	328	
HLRS 4030-01-180	4 Flutes	RO.1	18	2.4	60	6	350	
HLRS 2030-01-200	2 Flutes	RO.1	20	3	60	6	328	
HLRS 4030-01-200	4 Flutes	RO.1	20	2.4	60	6	350	
HLRS 4030-01-240		RO.1	24	2.4	70	6	350	
HLRS 2030-01-260	2 Flutes	RO.1	26	3	70	6	328	
HLRS 4030-01-260	4 Flutes	RO.1	26	2.4	70	6	350	
HLRS 2030-01-300	2 Flutes	RO.1	30	3	70	6	328	
HLRS 4030-01-300	4 Flutes	RO.1	30	2.4	70	6	350	
HLRS 2030-01-360	2 Flutes	RO.1	36	3	80	6	328	
C-CRS 2030-02		RO.2	—	10	45	6	290	
CXERS 4030-02-075	4 Flutes	RO.2	—	7.5	60	6	298	
HMERS 4030-02-075		RO.2	—	7.5	60	6	312	

Simplified Table

Radius

Model Number	Number of Flutes	Outside Diameter	Corner Radius	Effective Length	Length of Cut	Overall Length	Shank Diameter	Page
HLRS 4030-02-040	4 Flutes	3	R0.2	4	2.4	55	6	350
HLRS 2030-02-060	2 Flutes		R0.2	6	3	55	6	328
HLRS 2030-02-060E	2 Flutes		R0.2	6	3	55	6	328
HLRS 4030-02-060	4 Flutes		R0.2	6	2.4	55	6	350
CRS40HSP 3030-020-07	3 Flutes		R0.2	7	4	38	3	568
HLRS 4030-02-080	4 Flutes		R0.2	8	2.4	55	6	350
HLRS 4030-02-100			R0.2	10	2.4	55	6	350
HLRS 2030-02-120	2 Flutes		R0.2	12	3	55	6	328
HLRS 4030-02-120	4 Flutes		R0.2	12	2.4	55	6	350
CRS40HSP 3030-020-14	3 Flutes		R0.2	14	4	60	3	568
HLRS 2030-02-160	2 Flutes		R0.2	16	3	60	6	328
HLRS 2030-02-160E			R0.2	16	3	60	6	328
HLRS 4030-02-160	4 Flutes		R0.2	16	2.4	60	6	350
DLRS 4030-02-160			R0.2	16	6	60	4	377
HLRS 2030-02-180	2 Flutes		R0.2	18	3	60	6	328
HLRS 4030-02-180	4 Flutes		R0.2	18	2.4	60	6	350
HLRS 2030-02-200	2 Flutes		R0.2	20	3	60	6	328
HLRS 4030-02-200	4 Flutes		R0.2	20	2.4	60	6	350
DLRS 4030-02-200			R0.2	20	6	60	4	377
HLRS 4030-02-240	2 Flutes		R0.2	24	2.4	70	6	350
HLRS 2030-02-260	2 Flutes		R0.2	26	3	70	6	328
HLRS 4030-02-260	4 Flutes		R0.2	26	2.4	70	6	350
HLRS 2030-02-300	2 Flutes		R0.2	30	3	70	6	328
HLRS 4030-02-300	4 Flutes		R0.2	30	2.4	70	6	350
DLRS 4030-02-300			R0.2	30	6	80	4	377
HLRS 2030-02-360	2 Flutes		R0.2	36	3	80	6	328
HLRS 4030-02-360	4 Flutes		R0.2	36	2.4	80	6	350
C-CRS 2030-03	2 Flutes		R0.3	—	10	45	6	290
CKERS 4030-03-075	4 Flutes		R0.3	—	7.5	60	6	298
HMERS 4030-03-075			R0.3	—	7.5	60	6	312
HLRS 4030-03-040			R0.3	4	2.4	55	6	350
HLRS 2030-03-060			R0.3	6	3	55	6	328
HLRS 2030-03-060E	2 Flutes	R0.3	6	3	55	6	328	
HLRS 4030-03-060	4 Flutes	R0.3	6	2.4	55	6	350	
CRS20HSP 4030-030-07		R0.3	7	4	50	6	570	
HLRS 4030-03-080	4 Flutes	R0.3	8	2.4	55	6	350	
HLRS 4030-03-100		R0.3	10	2.4	55	6	350	
HLRS 2030-03-120	2 Flutes	R0.3	12	3	55	6	328	
HLRS 4030-03-120	4 Flutes	R0.3	12	2.4	55	6	350	
HLRS 4030-03-140		R0.3	14	2.4	55	6	350	

Model Number	Number of Flutes	Outside Diameter	Corner Radius	Effective Length	Length of Cut	Overall Length	Shank Diameter	Page
HLRS 2030-03-160	2 Flutes	3	R0.3	16	3	60	6	328
HLRS 2030-03-160E			R0.3	16	3	60	6	328
HLRS 4030-03-160	4 Flutes		R0.3	16	2.4	60	6	350
HLRS 2030-03-180	2 Flutes		R0.3	18	3	60	6	328
HLRS 2030-03-200			R0.3	20	3	60	6	328
HLRS 4030-03-200	4 Flutes		R0.3	20	2.4	60	6	350
HLRS 4030-03-240			R0.3	24	2.4	70	6	350
HLRS 2030-03-260	2 Flutes		R0.3	26	3	70	6	328
HLRS 4030-03-260	4 Flutes		R0.3	26	2.4	70	6	350
HLRS 2030-03-300	2 Flutes		R0.3	30	3	70	6	328
HLRS 4030-03-300	4 Flutes		R0.3	30	2.4	70	6	350
HLRS 2030-03-360	2 Flutes		R0.3	36	3	80	6	328
HLRS 4030-03-360	4 Flutes		R0.3	36	2.4	80	6	350
C-CRS 2030-05	2 Flutes		R0.5	—	10	45	6	290
CKERS 4030-05-075	4 Flutes		R0.5	—	7.5	60	6	298
HMERS 4030-05-075			R0.5	—	7.5	60	6	312
CKRS 5030-05-0600	5 Flutes		R0.5	—	6	50	6	309
CKRS 5030-05-0900			R0.5	—	9	50	6	309
HLRS 4030-05-040	4 Flutes		R0.5	4	2.4	55	6	352
HLRS 2030-05-060	2 Flutes		R0.5	6	3	55	6	328
HLRS 2030-05-060E			R0.5	6	3	55	6	328
HLRS 4030-05-060	4 Flutes		R0.5	6	2.4	55	6	352
HLRS 4030-05-080			R0.5	8	2.4	55	6	352
CLRS 5030-05-09	5 Flutes		R0.5	9	6	50	6	381
HLRS 4030-05-100	4 Flutes		R0.5	10	2.4	55	6	352
HLRS 2030-05-120	2 Flutes		R0.5	12	3	55	6	328
HLRS 4030-05-120	4 Flutes		R0.5	12	2.4	55	6	352
CLRS 5030-05-12	5 Flutes		R0.5	12	6	50	6	381
HLRS 2030-05-160	2 Flutes		R0.5	16	3	60	6	328
HLRS 2030-05-160E			R0.5	16	3	60	6	328
HLRS 4030-05-160	4 Flutes		R0.5	16	2.4	60	6	352
DLRS 4030-05-160			R0.5	16	6	60	4	377
HLRS 2030-05-180	2 Flutes	R0.5	18	3	60	6	328	
HLRS 2030-05-200		R0.5	20	3	60	6	328	
HLRS 4030-05-200	4 Flutes	R0.5	20	2.4	60	6	352	
DLRS 4030-05-200		R0.5	20	6	60	4	377	
HLRS 4030-05-240	4 Flutes	R0.5	24	2.4	70	6	352	
HLRS 2030-05-260	2 Flutes	R0.5	26	3	70	6	328	
HLRS 4030-05-260	4 Flutes	R0.5	26	2.4	70	6	352	
HLRS 2030-05-300	2 Flutes	R0.5	30	3	70	6	328	

Simplified Table

Radius																			
Model Number		Number of Flutes	Outside Diameter	Corner Radius	Effective Length	Length of Cut	Overall Length	Shank Diameter	Page										
Model Number	Number of Flutes	Outside Diameter	Corner Radius	Effective Length	Length of Cut	Overall Length	Shank Diameter	Page	Model Number	Number of Flutes	Outside Diameter	Corner Radius	Effective Length	Length of Cut	Overall Length	Shank Diameter	Page		
HLRS	4030-05-300	4 Flutes	3	R0.5	30	2.4	70	6	352	HLRS	4040-01-080	4 Flutes	4	R0.1	8	3.2	65	6	352
DCLRS	4030-05-300			R0.5	30	6	80	4	377	CPRS25NSP	2040-010-12	2 Flutes		R0.1	12	5	50	4	564
HLRS	2030-05-360	2 Flutes		R0.5	36	3	80	6	328	HLRS	2040-01-120	4 Flutes		R0.1	12	4	65	6	330
HLRS	4030-05-360			R0.5	36	2.4	80	6	352	HLRS	4040-01-120	2 Flutes		R0.1	16	4	65	6	330
HRRS	4030-08-09-3S	4 Flutes		R0.8	9	3	50	3	368	HLRS	2040-01-160	4 Flutes		R0.1	16	3.2	65	6	352
HRRS	4030-08-09S			R0.8	9	3	50	6	368	HLRS	4040-01-160	2 Flutes		R0.1	20	4	65	6	330
HRRS	4030-08-09-3			R0.8	9	3	70	3	362	HLRS	2040-01-200	4 Flutes		R0.1	16	3.2	65	6	352
HRRS	4030-08-09			R0.8	9	3	70	6	362	HLRS	4040-01-200	2 Flutes		R0.1	20	4	65	6	330
CRRS	4030-08-09			R0.8	9	3	70	6	370	HLRS	2040-01-200E	4 Flutes		R0.1	20	4	65	6	330
C-CRS	2030-10			2 Flutes	R1	—	10	45	6	290	HLRS	4040-01-200		2 Flutes	R0.1	20	3.2	70	6
HLRS	2030-10-060	R1			6	3	55	6	330	HLRS	2040-01-240	4 Flutes		R0.1	24	4	70	6	330
HLRS	2030-10-060E	4 Flutes		R1	6	3	55	6	330	HLRS	4040-01-240	2 Flutes		R0.1	24	3.2	70	6	352
HLRS	4030-10-060			R1	6	2.4	55	6	352	HLRS	2040-01-320	4 Flutes		R0.1	32	4	80	6	330
HLRS	4030-10-080	2 Flutes		R1	8	2.4	55	6	352	HLRS	4040-01-320	2 Flutes		R0.1	32	3.2	80	6	352
HLRS	4030-10-100			R1	10	2.4	55	6	352	HLRS	2040-01-480	4 Flutes		R0.1	48	4	100	6	330
HLRS	2030-10-120	4 Flutes		R1	12	3	55	6	330	HLRS	4040-01-480	2 Flutes		R0.1	48	3.2	100	6	352
HLRS	4030-10-120			R1	12	2.4	55	6	352	HLRS	2040-01-480	4 Flutes		R0.1	48	3.2	100	6	352
HLRS	2030-10-160	2 Flutes		R1	16	3	60	6	330	C-CRS	2040-02	2 Flutes		R0.2	—	12	45	6	291
HLRS	2030-10-160E		R1	16	3	60	6	330	HMERS	4040-02-100	4 Flutes	R0.2	—	10	60	6	312		
HLRS	4030-10-160	4 Flutes	R1	16	2.4	60	6	352	CXERS	4040-02-100		R0.2	—	10	60	6	299		
HLRS	2030-10-180		2 Flutes	R1	18	3	60	6	330	HLRS	2040-02-080	2 Flutes	R0.2	8	4	65	6	330	
HLRS	2030-10-200	R1		20	3	60	6	330	HLRS	2040-02-080E	4 Flutes	R0.2	8	4	65	6	330		
HLRS	4030-10-200	4 Flutes	R1	20	2.4	60	6	352	HLRS	4040-02-080		R0.2	8	3.2	65	6	352		
HLRS	4030-10-240		R1	24	2.4	70	6	352	CRS40HSP	3040-020-09	3 Flutes	R0.2	9	5	50	6	568		
HLRS	2030-10-260	2 Flutes	R1	26	3	70	6	330	HLRS	2040-02-120	2 Flutes	R0.2	12	4	65	6	330		
HLRS	4030-10-260		R1	26	2.4	70	6	352	HLRS	4040-02-120	4 Flutes	R0.2	12	3.2	65	6	352		
HLRS	2030-10-300	2 Flutes	R1	30	3	70	6	330	HLRS	2040-02-160	2 Flutes	R0.2	16	4	65	6	330		
HLRS	4030-10-300		R1	30	2.4	70	6	352	HLRS	4040-02-160	4 Flutes	R0.2	16	3.2	65	6	352		
HLRS	2030-10-360	2 Flutes	R1	36	3	80	6	330	CRS40HSP	3040-020-18	3 Flutes	R0.2	18	5	65	6	568		
HLRS	4030-10-360		R1	36	2.4	80	6	352	HLRS	2040-02-200	2 Flutes	R0.2	20	4	65	6	330		
CRS40HSP	3035-020-09	3 Flutes	3.5	R0.2	9	5	50	6	568	HLRS	2040-02-200E	4 Flutes	R0.2	20	4	65	6	330	
HLRS	4040-005-080	4 Flutes	R0.05	8	3.2	65	6	352	DCLRS	4040-02-200	4 Flutes		R0.2	20	8	60	6	377	
HLRS	4040-005-120		R0.05	12	3.2	65	6	352	HLRS	4040-02-200	2 Flutes	R0.2	20	3.2	70	6	352		
HLRS	4040-005-160		R0.05	16	3.2	65	6	352	HLRS	2040-02-240	2 Flutes	R0.2	24	4	70	6	330		
HLRS	4040-005-200		R0.05	20	3.2	70	6	352	HLRS	4040-02-240	4 Flutes	R0.2	24	3.2	70	6	352		
HLRS	4040-005-240		R0.05	24	3.2	70	6	352	DCLRS	4040-02-300		R0.2	30	8	80	6	377		
HLRS	4040-005-320		R0.05	32	3.2	80	6	352	HLRS	2040-02-320	2 Flutes	R0.2	32	4	80	6	330		
HMERS	4040-01-100	2 Flutes	R0.1	—	10	60	6	312	HLRS	4040-02-320	4 Flutes	R0.2	32	3.2	80	6	352		
HLRS	2040-01-080		R0.1	8	4	65	6	330	DCLRS	4040-02-400	4 Flutes	R0.2	40	8	80	6	377		
HLRS	2040-01-080E		R0.1	8	4	65	6	330	HLRS	2040-02-480	2 Flutes	R0.2	48	4	100	6	330		
HLRS	2040-01-080E		R0.1	8	4	65	6	330	HLRS	4040-02-480	4 Flutes	R0.2	48	3.2	100	6	352		
									C-CRS	2040-03	2 Flutes	R0.3	—	12	45	6	291		

Simplified Table

Radius

Model Number	Number of Flutes	Outside Diameter	Corner Radius	Effective Length	Length of Cut	Overall Length	Shank Diameter	Page
HMERS 4040-03-100	4 Flutes		R0.3	—	10	60	6	312
CXERS 4040-03-100			R0.3	—	10	60	6	299
HLRS 2040-03-080	2 Flutes		R0.3	8	4	65	6	330
HLRS 2040-03-080E			R0.3	8	4	65	6	330
HLRS 4040-03-080	4 Flutes		R0.3	8	3.2	65	6	354
CRS40HSP 3040-030-09	3 Flutes		R0.3	9	5	50	6	568
CPRS30N 2040-030-10	2 Flutes		R0.3	10	5	50	6	566
HLRS 2040-03-120			R0.3	12	4	65	6	330
CRRS 4040-03-12	4 Flutes		R0.3	12	4	60	6	370
HLRS 4040-03-120			R0.3	12	3.2	65	6	354
HRRS 4040-03-12-6			R0.3	12	4	70	6	362
HLRS 4040-03-140			R0.3	14	3.2	65	6	354
HLRS 2040-03-160	2 Flutes		R0.3	16	4	65	6	330
HLRS 4040-03-160	4 Flutes		R0.3	16	3.2	65	6	354
HLRS 2040-03-200	2 Flutes		R0.3	20	4	65	6	330
HLRS 2040-03-200E			R0.3	20	4	65	6	330
HLRS 4040-03-200	4 Flutes		R0.3	20	3.2	70	6	354
HRRS 4040-03-20-6			R0.3	20	4	70	6	362
HLRS 2040-03-240	2 Flutes		R0.3	24	4	70	6	330
HLRS 4040-03-240	4 Flutes	4	R0.3	24	3.2	70	6	354
HLRS 2040-03-320	2 Flutes		R0.3	32	4	80	6	330
HLRS 4040-03-320	4 Flutes		R0.3	32	3.2	80	6	354
HLRS 2040-03-480	2 Flutes		R0.3	48	4	100	6	330
HLRS 4040-03-480	4 Flutes		R0.3	48	3.2	100	6	354
CXERS 4040-04-100			R0.4	—	10	60	6	299
CRS40HSP 4040-040-09	3 Flutes		R0.4	9	5	50	6	570
C-CRS 2040-05	2 Flutes		R0.5	—	12	45	6	291
HMERS 4040-05-100	4 Flutes		R0.5	—	10	60	6	312
CXERS 4040-05-100			R0.5	—	10	60	6	299
CRRS 5040-05-0800	5 Flutes		R0.5	—	8	60	6	309
CRRS 5040-05-1200			R0.5	—	12	60	6	309
HLRS 2040-05-080	2 Flutes		R0.5	8	4	65	6	330
HLRS 2040-05-080E			R0.5	8	4	65	6	330
HLRS 4040-05-080	4 Flutes		R0.5	8	3.2	65	6	354
CRS40HSP 3040-050-09	3 Flutes		R0.5	9	5	50	6	568
HLRS 2040-05-120	2 Flutes		R0.5	12	4	65	6	330
HRRS 4040-05-12S	4 Flutes		R0.5	12	4	50	4	368
HRRS 4040-05-12-6S			R0.5	12	4	50	6	368
CRRS 4040-05-12			R0.5	12	4	60	6	370
HLRS 4040-05-120			R0.5	12	3.2	65	6	354

Model Number	Number of Flutes	Outside Diameter	Corner Radius	Effective Length	Length of Cut	Overall Length	Shank Diameter	Page
HRRS 4040-05-12	4 Flutes		R0.5	12	4	70	4	362
CRRS 4040-05-12-4			R0.5	12	4	70	4	370
HRRS 4040-05-12-6	5 Flutes		R0.5	12	4	70	6	362
CXLRs 5040-05-12			R0.5	12	8	60	6	381
HLRS 2040-05-160	2 Flutes		R0.5	16	4	65	6	330
HLRS 4040-05-160	4 Flutes		R0.5	16	3.2	65	6	354
CXLRs 5040-05-16	5 Flutes		R0.5	16	8	60	6	381
HLRS 2040-05-200	2 Flutes		R0.5	20	4	65	6	330
HLRS 2040-05-200E			R0.5	20	4	65	6	330
DCLRS 4040-05-200	4 Flutes		R0.5	20	8	60	6	377
HLRS 4040-05-200			R0.5	20	3.2	70	6	354
HRRS 4040-05-20-6			R0.5	20	4	70	6	362
HLRS 2040-05-240			2 Flutes		R0.5	24	4	70
HLRS 4040-05-240	4 Flutes		R0.5	24	3.2	70	6	354
DCLRS 4040-05-300			R0.5	30	8	80	6	377
HLRS 2040-05-320	2 Flutes		R0.5	32	4	80	6	330
HLRS 4040-05-320	4 Flutes		R0.5	32	3.2	80	6	354
DCLRS 4040-05-400			R0.5	40	8	80	6	377
HLRS 4040-05-400	2 Flutes		R0.5	40	3.2	100	6	354
HLRS 2040-05-480			R0.5	48	4	100	6	330
HLRS 4040-05-480	4 Flutes	4	R0.5	48	3.2	100	6	354
C-CRS 2040-10	2 Flutes		R1	—	12	45	6	291
HMERS 4040-10-100	4 Flutes		R1	—	10	60	6	312
CXERS 4040-10-100			R1	—	10	60	6	299
CRRS 5040-10-0800	5 Flutes		R1	—	8	60	6	309
CRRS 5040-10-1200			R1	—	12	60	6	309
HLRS 2040-10-080	2 Flutes		R1	8	4	65	6	332
HLRS 2040-10-080E			R1	8	4	65	6	332
HLRS 4040-10-080	4 Flutes		R1	8	3.2	65	6	354
HLRS 2040-10-120	2 Flutes		R1	12	4	65	6	332
HRRS 4040-10-12S	4 Flutes		R1	12	4	50	4	368
HRRS 4040-10-12-6S			R1	12	4	50	6	368
HLRS 4040-10-120			R1	12	3.2	65	6	354
HRRS 4040-10-12			R1	12	4	70	4	362
CRRS 4040-10-12-4	5 Flutes		R1	12	4	70	4	370
HRRS 4040-10-12-6			R1	12	4	70	6	362
CRRS 4040-10-12	2 Flutes		R1	12	4	70	6	370
CXLRs 5040-10-12			R1	12	8	60	6	381
HLRS 2040-10-160	2 Flutes		R1	16	4	65	6	332
HLRS 4040-10-160	4 Flutes		R1	16	3.2	65	6	354

Simplified Table

Radius									
Model Number	Number of Flutes	Outside Diameter	Corner Radius	Effective Length	Length of Cut	Overall Length	Shank Diameter	Page	
CXLRs	5040-10-16	5 Flutes	R1	16	8	60	6	381	
HLRS	2040-10-200	2 Flutes		R1	20	4	65	6	332
HLRS	2040-10-200E		R1	20	4	65	6	332	
HLRS	4040-10-200	4 Flutes	R1	20	3.2	70	6	354	
HRRS	4040-10-20-6		R1	20	4	70	6	362	
HLRS	2040-10-240	2 Flutes	R1	24	4	70	6	332	
HLRS	4040-10-240	4 Flutes		R1	24	3.2	70	6	354
HLRS	2040-10-320	2 Flutes	R1	32	4	80	6	332	
HLRS	4040-10-320	4 Flutes		R1	32	3.2	80	6	354
HLRS	2040-10-480	2 Flutes	R1	48	4	100	6	332	
HLRS	4040-10-480	4 Flutes		R1	48	3.2	100	6	354
HLRS	4050-005-160		RO.05	16	4	65	6	354	
HLRS	4050-005-200		RO.05	20	4	70	6	354	
HLRS	4050-005-400		RO.05	40	4	100	6	354	
HMERS	4050-01-125		RO.1	—	12.5	60	6	312	
CPRS25HSP	2050-01-14		2 Flutes	RO.1	14	8	50	6	564
HLRS	4050-01-160		4 Flutes	RO.1	16	4	65	6	354
HLRS	4050-01-200	RO.1		20	4	70	6	354	
HLRS	4050-01-400	RO.1	40	4	100	6	354		
C-CRS	2050-02	2 Flutes	RO.2	—	15	50	6	291	
HMERS	4050-02-125	4 Flutes	RO.2	—	12.5	60	6	312	
CXERS	4050-02-125		RO.2	—	12.5	60	6	299	
CRS40HSP	3050-020-11	3 Flutes	RO.2	11	6	50	6	568	
HLRS	4050-02-160	4 Flutes	RO.2	16	4	65	6	354	
HLRS	2050-02-200	2 Flutes	RO.2	20	5	70	6	332	
HLRS	4050-02-200	4 Flutes	R2	20	4	70	6	354	
CRS40HSP	3050-020-22	3 Flutes		RO.2	22	6	65	6	568
HLRS	2050-02-400	2 Flutes		RO.2	40	5	90	6	332
HLRS	4050-02-400	4 Flutes		RO.2	40	4	100	6	354
C-CRS	2050-03	2 Flutes		RO.3	—	15	50	6	291
HMERS	4050-03-125	4 Flutes		RO.3	—	12.5	60	6	312
CXERS	4050-03-125			RO.3	—	12.5	60	6	299
HLRS	4050-03-160	RO.3	16	4	65	6	354		
HLRS	2050-03-200	2 Flutes	RO.3	20	5	70	6	332	
HLRS	4050-03-200	4 Flutes	RO.3	20	4	70	6	354	
HLRS	2050-03-400	2 Flutes	RO.3	40	5	90	6	332	
HLRS	4050-03-400	4 Flutes	RO.3	40	4	100	6	354	
CXERS	4050-04-125		RO.4	—	12.5	60	6	299	
C-CRS	2050-05	2 Flutes	RO.5	—	15	50	6	291	
HMERS	4050-05-125	4 Flutes	RO.5	—	12.5	60	6	312	

Model Number	Number of Flutes	Outside Diameter	Corner Radius	Effective Length	Length of Cut	Overall Length	Shank Diameter	Page
CXERS	4050-05-125	4 Flutes	RO.5	—	12.5	60	6	299
CRS20HSP	4050-050-12		RO.5	12	6	50	6	570
HLRS	4050-05-160	RO.5	16	4	65	6	354	
HLRS	2050-05-200	2 Flutes	RO.5	20	5	70	6	332
HLRS	4050-05-200	4 Flutes	RO.5	20	4	70	6	354
HLRS	2050-05-400	2 Flutes	RO.5	40	5	90	6	332
HLRS	4050-05-400	4 Flutes	RO.5	40	4	100	6	354
C-CRS	2050-10	2 Flutes	R1	—	15	50	6	291
HMERS	4050-10-125	4 Flutes	R1	—	12.5	60	6	312
CXERS	4050-10-125		R1	—	12.5	60	6	299
HLRS	4050-10-160	RO.5	16	4	65	6	354	
HLRS	2050-10-200	2 Flutes	R1	20	5	70	6	332
HLRS	4050-10-200	4 Flutes	R1	20	4	70	6	354
HLRS	2050-10-400	2 Flutes	R1	40	5	90	6	332
HLRS	4050-10-400	4 Flutes	R1	40	4	100	6	354
HRRS	4050-12-15S		R1.2	15	5	50	6	368
HRRS	4050-12-15	R1.2	15	5	70	6	363	
CRRS	4050-12-15	R1.2	15	5	70	6	370	
HLRS	4060-005-120	4 Flutes	RO.05	12	4.8	65	6	356
HLRS	4060-005-160		RO.05	16	4.8	65	6	356
HLRS	4060-005-200		RO.05	20	4.8	70	6	356
HLRS	4060-005-240		RO.05	24	4.8	70	6	356
HLRS	4060-005-300		RO.05	30	4.8	100	6	356
HLRS	4060-005-480	RO.05	48	4.8	120	6	356	
CPRS25HSP	2060-010	2 Flutes	RO.1	—	13	50	6	564
HMERS	6060-01-130	6 Flutes	RO.1	—	13	60	6	313
HLRS	2060-01-120	2 Flutes	RO.1	12	6	65	6	332
HLRS	2060-01-120E		RO.1	12	6	65	6	332
HLRS	4060-01-120	4 Flutes	RO.1	12	4.8	65	6	356
HLRS	4060-01-160		RO.1	16	4.8	65	6	356
CPRS25HSP	2060-010-18	2 Flutes	RO.1	18	8	65	6	564
HLRS	4060-01-180	4 Flutes	RO.1	18	4.8	70	6	356
HLRS	2060-01-200	2 Flutes	RO.1	20	6	70	6	332
HLRS	4060-01-200	4 Flutes	RO.1	20	4.8	70	6	356
HRRS	6060-01-210	6 Flutes	RO.1	21	6	60	6	384
HLRS	4060-01-240	4 Flutes	RO.1	24	4.8	70	6	356
HLRS	2060-01-300	2 Flutes	RO.1	30	6	100	6	332
HLRS	2060-01-300E		RO.1	30	6	100	6	332
HLRS	4060-01-300	4 Flutes	RO.1	30	4.8	100	6	356
HLRS	4060-01-480		RO.1	48	4.8	120	6	356

Simplified Table

Radius

Model Number	Number of Flutes	Outside Diameter	Corner Radius	Effective Length	Length of Cut	Overall Length	Shank Diameter	Page
HLRS 2060-01-600	2 Flutes	6	R0.1	60	6	120	6	332
C-CRS 2060-02			R0.2	—	15	50	6	291
CKERS 4060-02-150	4 Flutes		R0.2	—	15	60	6	299
HMERS 6060-02-130	6 Flutes		R0.2	—	13	60	6	313
HLRS 2060-02-120	2 Flutes		R0.2	12	6	65	6	332
HLRS 2060-02-120E			R0.2	12	6	65	6	332
HLRS 4060-02-120	4 Flutes		R0.2	12	4.8	65	6	356
CRS40HSP 3060-020-14	3 Flutes		R0.2	14	7	60	6	568
HLRS 4060-02-160	4 Flutes		R0.2	16	4.8	65	6	356
HLRS 4060-02-180			R0.2	18	4.8	70	6	356
HLRS 2060-02-200	2 Flutes		R0.2	20	6	70	6	332
HLRS 4060-02-200	4 Flutes		R0.2	20	4.8	70	6	356
HHRS 6060-02-210	6 Flutes		R0.2	21	6	60	6	384
HLRS 4060-02-240	4 Flutes		R0.2	24	4.8	70	6	356
HLRS 2060-02-300	2 Flutes		R0.2	30	6	100	6	332
HLRS 2060-02-300E			R0.2	30	6	100	6	332
HLRS 4060-02-300	4 Flutes		R0.2	30	4.8	100	6	356
DCLRS 4060-02-300			R0.2	30	12	100	6	377
HLRS 4060-02-480	2 Flutes		R0.2	48	4.8	120	6	356
HLRS 2060-02-600			R0.2	60	6	120	6	332
DCLRS 4060-02-600	4 Flutes	R0.2	60	12	120	6	377	
CPRS30N 2060-025-20	2 Flutes	R0.25	20	8	60	6	566	
C-CRS 2060-03		R0.3	—	15	50	6	291	
CKERS 4060-03-150	4 Flutes	R0.3	—	15	60	6	299	
HMERS 6060-03-130	6 Flutes	R0.3	—	13	60	6	313	
HLRS 2060-03-120	2 Flutes	R0.3	12	6	65	6	332	
HLRS 2060-03-120E		R0.3	12	6	65	6	332	
HLRS 4060-03-120	4 Flutes	R0.3	12	4.8	65	6	356	
CRS40HSP 3060-030-14	3 Flutes	R0.3	14	7	60	6	568	
HLRS 4060-03-160	4 Flutes	R0.3	16	4.8	65	6	356	
HLRS 4060-03-180		R0.3	18	4.8	70	6	356	
HHRS 4060-03-18		R0.3	18	6	90	6	363	
CRRS 4060-03-18		R0.3	18	6	90	6	370	
HLRS 2060-03-200	2 Flutes	R0.3	20	6	70	6	332	
HLRS 4060-03-200	4 Flutes	R0.3	20	4.8	70	6	356	
HHRS 6060-03-210	6 Flutes	R0.3	21	6	60	6	384	
HLRS 4060-03-240	4 Flutes	R0.3	24	4.8	70	6	356	
CRS40HSP 3060-030-26	3 Flutes	R0.3	26	7	80	6	568	
HLRS 2060-03-300	2 Flutes	R0.3	30	6	100	6	332	
HLRS 2060-03-300E		R0.3	30	6	100	6	332	

Model Number	Number of Flutes	Outside Diameter	Corner Radius	Effective Length	Length of Cut	Overall Length	Shank Diameter	Page
HHRS 4060-03-30	4 Flutes	6	R0.3	30	6	90	6	363
HLRS 4060-03-300			R0.3	30	4.8	100	6	356
HLRS 4060-03-480	R0.3		48	4.8	120	6	356	
HLRS 2060-03-600	2 Flutes		R0.3	60	6	120	6	332
CKERS 4060-04-150	4 Flutes		R0.4	—	15	60	6	299
C-CRS 2060-05	2 Flutes		R0.5	—	15	50	6	291
CKERS 4060-05-150	4 Flutes		R0.5	—	15	60	6	299
CRRS 4060-05-16			R0.5	—	16	90	6	294
CRRS 5060-05-1200	5 Flutes		R0.5	—	12	70	6	309
CRRS 5060-05-1800			R0.5	—	18	70	6	309
HMERS 6060-05-130	6 Flutes		R0.5	—	13	60	6	313
HLRS 2060-05-120	2 Flutes		R0.5	12	6	65	6	332
HLRS 2060-05-120E			R0.5	12	6	65	6	332
HLRS 4060-05-120	4 Flutes		R0.5	12	4.8	65	6	356
CRS40HSP 3060-050-14	3 Flutes		R0.5	14	7	60	6	568
HLRS 4060-05-160	4 Flutes		R0.5	16	4.8	65	6	356
HLRS 4060-05-180			R0.5	18	4.8	70	6	356
HHRS 4060-05-18S			R0.5	18	6	50	6	368
CRRS 4060-05-18			R0.5	18	6	60	6	370
HLRS 4060-05-18	5 Flutes		R0.5	18	6	90	6	363
CLRS 5060-05-18		R0.5	18	12	70	6	381	
CPRS30N 2060-050-20	2 Flutes	R0.5	20	8	60	6	566	
HLRS 2060-05-200		R0.5	20	6	70	6	332	
HLRS 4060-05-200	4 Flutes	R0.5	20	4.8	70	6	356	
HHRS 6060-05-210	6 Flutes	R0.5	21	6	60	6	384	
HLRS 4060-05-240	4 Flutes	R0.5	24	4.8	70	6	356	
CLRS 5060-05-24	5 Flutes	R0.5	24	12	70	6	381	
HLRS 2060-05-300	2 Flutes	R0.5	30	6	100	6	332	
HLRS 2060-05-300E		R0.5	30	6	100	6	332	
HHRS 4060-05-30	4 Flutes	R0.5	30	6	90	6	363	
HLRS 4060-05-300		R0.5	30	4.8	100	6	356	
DCLRS 4060-05-300		R0.5	30	12	100	6	377	
HLRS 4060-05-400		R0.5	40	4.8	100	6	356	
HLRS 4060-05-480	2 Flutes	R0.5	48	4.8	120	6	356	
HLRS 2060-05-600		R0.5	60	6	120	6	332	
DCLRS 4060-05-600	4 Flutes	R0.5	60	12	120	6	377	
CRS20HSP 4060-060-14		R0.6	14	7	55	6	570	
C-CRS 2060-10	2 Flutes	R1	—	15	50	6	291	
CKERS 4060-10-150	4 Flutes	R1	—	15	60	6	299	
CRRS 4060-10-16		R1	—	16	90	6	294	

Simplified Table

Radius

Model Number	Number of Flutes	Outside Diameter	Corner Radius	Effective Length	Length of Cut	Overall Length	Shank Diameter	Page
CXRS 5060-10-1200	5 Flutes		R1	—	12	70	6	309
CXRS 5060-10-1800			R1	—	18	70	6	309
HMERS 6060-10-130	6 Flutes		R1	—	13	60	6	313
HLRS 2060-10-120	2 Flutes		R1	12	6	65	6	332
HLRS 2060-10-120E			R1	12	6	65	6	332
HLRS 4060-10-120	4 Flutes		R1	12	4.8	65	6	356
HLRS 4060-10-160			R1	16	4.8	65	6	356
HLRS 4060-10-180			R1	18	4.8	70	6	356
HRRS 4060-10-18S			R1	18	6	50	6	368
CRRS 4060-10-18			R1	18	6	60	6	370
HRRS 4060-10-18			R1	18	6	90	6	363
CXLRs 5060-10-18	5 Flutes		R1	18	12	70	6	381
HLRS 2060-10-200	2 Flutes		R1	20	6	70	6	332
HLRS 4060-10-200	4 Flutes		R1	20	4.8	70	6	356
HRRS 6060-10-210	6 Flutes		R1	21	6	60	6	384
HLRS 4060-10-240	4 Flutes		R1	24	4.8	70	6	356
CXLRs 5060-10-24	5 Flutes		R1	24	12	70	6	381
HLRS 2060-10-300	2 Flutes		R1	30	6	100	6	332
HLRS 2060-10-300E			R1	30	6	100	6	332
HRRS 4060-10-30	4 Flutes		R1	30	6	90	6	363
HLRS 4060-10-300			R1	30	4.8	100	6	356
HLRS 4060-10-400			R1	40	4.8	100	6	356
HLRS 4060-10-480			R1	48	4.8	120	6	356
HLRS 2060-10-600	2 Flutes		R1	60	6	120	6	332
CXERS 4060-12-150	4 Flutes		R1.2	—	15	60	6	299
C-CRS 2060-15	2 Flutes		R1.5	—	15	50	6	291
HMERS 6060-15-130	6 Flutes		R1.5	—	13	60	6	313
HRRS 4060-15-18S	4 Flutes		R1.5	18	6	50	6	368
HRRS 4060-15-18			R1.5	18	6	90	6	363
CRRS 4060-15-18			R1.5	18	6	90	6	370
HRRS 4060-15-30			R1.5	30	6	90	6	363
C-CRS 2060-20	2 Flutes		R2	—	15	50	6	291
HRRS 4060-20-18S	4 Flutes		R2	18	6	50	6	368
HRRS 4060-20-18			R2	18	6	90	6	363
CPRS25NSP 2080-010	2 Flutes		RO.1	—	13	50	8	564
CPRS25NSP 2080-010-22			RO.1	22	10	80	8	564
CXERS 4080-02-200	4 Flutes		RO.2	—	20	70	8	299
HMERS 6080-02-190	6 Flutes		RO.2	—	19	70	8	313
CRS40HSP 3080-020-18	3 Flutes		RO.2	18	9	60	8	569
CXERS 4080-03-200	4 Flutes		RO.3	—	20	70	8	299

Model Number	Number of Flutes	Outside Diameter	Corner Radius	Effective Length	Length of Cut	Overall Length	Shank Diameter	Page
HMERS 6080-03-190	6 Flutes		RO.3	—	19	70	8	313
HRRS 4080-03-24	4 Flutes		RO.3	24	8	100	8	363
CRRS 4080-03-24			RO.3	24	8	100	8	370
HRRS 6080-03-260	6 Flutes		RO.3	26	8	80	8	384
CPRS30N 2080-030-30	2 Flutes		RO.3	30	10	80	8	566
HRRS 4080-03-40	4 Flutes		RO.3	40	8	100	8	363
CXERS 4080-04-200			RO.4	—	20	70	8	299
C-CRS 2080-05	2 Flutes		RO.5	—	20	60	8	291
CXERS 4080-05-200	4 Flutes		RO.5	—	20	70	8	299
CNRS 4080-05-16			RO.5	—	16	100	8	294
CXRS 5080-05-1600	5 Flutes		RO.5	—	16	70	8	309
CXRS 5080-05-2400			RO.5	—	24	70	8	309
HMERS 6080-05-190	6 Flutes		RO.5	—	19	70	8	313
CRS40HSP 3080-050-18	3 Flutes		RO.5	18	9	60	8	569
HRRS 4080-05-24S	4 Flutes		RO.5	24	8	60	8	368
HRRS 4080-05-24			RO.5	24	8	100	8	363
CXLRs 5080-05-24	5 Flutes		RO.5	24	16	70	8	381
CRRS 4080-05-26	4 Flutes		RO.5	26	8	70	8	370
HRRS 6080-05-260	6 Flutes		RO.5	26	8	80	8	384
CXLRs 5080-05-32	5 Flutes		RO.5	32	16	70	8	381
CRS40HSP 3080-050-36			RO.5	36	9	90	8	569
HRRS 4080-05-40	4 Flutes		RO.5	40	8	100	8	363
CPRS30N 2080-060-30	2 Flutes		RO.6	30	10	80	8	566
CRS20HSP 4080-080-18	4 Flutes		RO.8	18	10	60	8	570
C-CRS 2080-10	2 Flutes		R1	—	20	60	8	291
CXERS 4080-10-200	4 Flutes		R1	—	20	70	8	299
CNRS 4080-10-16			R1	—	16	100	8	294
CXRS 5080-10-1600	5 Flutes		R1	—	16	70	8	309
CXRS 5080-10-2400			R1	—	24	70	8	309
HMERS 6080-10-190	6 Flutes		R1	—	19	70	8	313
HRRS 4080-10-24S	4 Flutes		R1	24	8	60	8	368
HRRS 4080-10-24			R1	24	8	100	8	363
CXLRs 5080-10-24	5 Flutes		R1	24	16	70	8	381
CRRS 4080-10-26	4 Flutes		R1	26	8	70	8	370
HRRS 6080-10-260	6 Flutes		R1	26	8	80	8	384
CXLRs 5080-10-32	5 Flutes		R1	32	16	70	8	381
HRRS 4080-10-40	4 Flutes		R1	40	8	100	8	363
CXERS 4080-12-200			R1.2	—	20	70	8	299
C-CRS 2080-15	2 Flutes		R1.5	—	20	60	8	291
CXERS 4080-15-200	4 Flutes		R1.5	—	20	70	8	299

Simplified Table

Radius

Model Number	Number of Flutes	Outside Diameter	Corner Radius	Effective Length	Length of Cut	Overall Length	Shank Diameter	Page	
C-CRS 2080-20	2 Flutes	8	R2	—	20	60	8	291	
CXERS 4080-20-200	4 Flutes		R2	—	20	70	8	299	
HMERS 6080-20-190	6 Flutes		R2	—	19	70	8	313	
HRRS 4080-20-24S	4 Flutes		R2	24	8	60	8	368	
HRRS 4080-20-24			R2	24	8	100	8	363	
CRRS 4080-20-24			R2	24	8	100	8	370	
HRRS 4080-20-40			R2	40	8	100	8	363	
C-CRS 2080-25	2 Flutes		10	R2.5	—	20	60	8	291
HRRS 4080-30-24S	4 Flutes			R3	24	8	60	8	368
HRRS 4080-30-24				R3	24	8	100	8	363
CPRS25NSP 2100-010-28	2 Flutes	RO.1		28	14	80	10	564	
CXERS 4100-02-250	4 Flutes	RO.2		—	25	80	10	299	
HMERS 6100-02-220	6 Flutes	RO.2		—	22	80	10	313	
CRS40HSP 3100-020-25	3 Flutes	RO.2		25	12	70	10	569	
CXERS 4100-03-250	4 Flutes	RO.3		—	25	80	10	299	
HMERS 6100-03-220	6 Flutes	RO.3		—	22	80	10	313	
HRRS 4100-03-30S	4 Flutes	RO.3		30	10	65	10	368	
HRRS 4100-03-30		RO.3	30	10	110	10	363		
CRRS 4100-03-30		RO.3	30	10	110	10	370		
HRRS 6100-03-310		6 Flutes	RO.3	31	10	80	10	384	
CPRS30N 2100-030-36	2 Flutes	RO.3	36	12	80	10	566		
HRRS 4100-03-50	4 Flutes	RO.3	50	10	110	10	363		
CXERS 4100-04-250		RO.4	—	25	80	10	299		
C-CRS 2100-05	2 Flutes	RO.5	—	25	70	10	291		
CXERS 4100-05-250	4 Flutes	RO.5	—	25	80	10	299		
CNRS 4100-05-26		RO.5	—	26	110	10	294		
CXRS 5100-05-2000	5 Flutes	RO.5	—	20	80	10	309		
CXRS 5100-05-3000		RO.5	—	30	80	10	309		
HMERS 6100-05-220	6 Flutes	RO.5	—	22	80	10	313		
CRS40HSP 3100-050-25	3 Flutes	RO.5	25	12	70	10	569		
HRRS 4100-05-30S	4 Flutes	RO.5	30	10	65	10	368		
CRRS 4100-05-30		RO.5	30	10	80	10	370		
HRRS 4100-05-30		RO.5	30	10	110	10	363		
CXLRs 5100-05-30		5 Flutes	RO.5	30	20	80	10	381	
HRRS 6100-05-310	6 Flutes	RO.5	31	10	80	10	384		
CXLRs 5100-05-40	5 Flutes	RO.5	40	20	80	10	381		
CRS40HSP 3100-050-45	3 Flutes	RO.5	45	12	100	10	569		
HRRS 4100-05-50	4 Flutes	RO.5	50	10	110	10	363		
CPRS30N 2100-080-36	2 Flutes	RO.8	36	12	80	10	566		
C-CRS 2100-10	2 Flutes	R1	—	25	70	10	291		

Model Number	Number of Flutes	Outside Diameter	Corner Radius	Effective Length	Length of Cut	Overall Length	Shank Diameter	Page
CXERS 4100-10-250	4 Flutes	10	R1	—	25	80	10	299
CNRS 4100-10-26			R1	—	26	110	10	294
CXRS 5100-10-2000	5 Flutes		R1	—	20	80	10	309
CXRS 5100-10-3000			R1	—	30	80	10	309
HMERS 6100-10-220	6 Flutes		R1	—	22	80	10	313
CRS20HSP 4100-100-25	4 Flutes		R1	25	12	70	10	570
HRRS 4100-10-30S			R1	30	10	65	10	368
CRRS 4100-10-30			R1	30	10	80	10	370
HRRS 4100-10-30			R1	30	10	110	10	363
CXLRs 5100-10-30	5 Flutes		R1	30	20	80	10	381
HRRS 6100-10-310	6 Flutes	R1	31	10	80	10	384	
CXLRs 5100-10-40	5 Flutes	R1	40	20	80	10	381	
HRRS 4100-10-50	4 Flutes	R1	50	10	110	10	363	
CXERS 4100-12-250		R1.2	—	25	80	10	299	
C-CRS 2100-15	2 Flutes	R1.5	—	25	70	10	291	
CXERS 4100-15-250	4 Flutes	R1.5	—	25	80	10	299	
CNRS 4100-15-26		R1.5	—	26	110	10	294	
CXRS 5100-15-2000	5 Flutes	R1.5	—	20	80	10	309	
CXRS 5100-15-3000		R1.5	—	30	80	10	309	
HMERS 6100-15-220	6 Flutes	R1.5	—	22	80	10	313	
CXLRs 5100-15-30	5 Flutes	R1.5	30	20	80	10	381	
CXLRs 5100-15-40		R1.5	40	20	80	10	381	
C-CRS 2100-20	2 Flutes	R2	—	25	70	10	291	
CXERS 4100-20-250	4 Flutes	R2	—	25	80	10	299	
CNRS 4100-20-26		R2	—	26	110	10	294	
CXRS 5100-20-2000	5 Flutes	R2	—	20	80	10	309	
CXRS 5100-20-3000		R2	—	30	80	10	309	
HMERS 6100-20-220	6 Flutes	R2	—	22	80	10	313	
HRRS 4100-20-30S	4 Flutes	R2	30	10	65	10	368	
HRRS 4100-20-30		R2	30	10	110	10	363	
CRRS 4100-20-30	5 Flutes	R2	30	10	110	10	370	
CXLRs 5100-20-30		R2	30	20	80	10	381	
CXLRs 5100-20-40		R2	40	20	80	10	381	
HRRS 4100-20-50	4 Flutes	R2	50	10	110	10	363	
C-CRS 2100-25	2 Flutes	R2.5	—	25	70	10	291	
C-CRS 2100-30		R3	—	25	70	10	291	
HRRS 4100-30-30S	4 Flutes	R3	30	10	65	10	368	
HRRS 4100-30-30		R3	30	10	110	10	363	
CPRS25NSP 2120-010-35	2 Flutes	RO.1	35	16	90	12	564	
CXERS 4120-02-300	4 Flutes	RO.2	—	30	100	12	299	

Simplified Table

Radius

Model Number	Number of Flutes	Outside Diameter	Corner Radius	Effective Length	Length of Cut	Overall Length	Shank Diameter	Page
HMERS	6120-02-260	6 Flutes	R0.2	—	26	100	12	313
CXERS	4120-03-300	4 Flutes	R0.3	—	30	100	12	299
HMERS	6120-03-260	6 Flutes	R0.3	—	26	100	12	313
HRRS	4120-03-36	4 Flutes	R0.3	36	12	120	12	363
CRRS	4120-03-36		R0.3	36	12	120	12	370
HRRS	6120-03-370	6 Flutes	R0.3	37	12	100	12	384
HRRS	4120-03-60	4 Flutes	R0.3	60	12	120	12	363
CXERS	4120-04-300		R0.4	—	30	100	12	299
C-CRS	2120-05	2 Flutes	R0.5	—	25	75	12	291
CXERS	4120-05-300	4 Flutes	R0.5	—	30	100	12	299
CNRS	4120-05-26		R0.5	—	26	120	12	294
CXRS	5120-05-2400	5 Flutes	R0.5	—	24	80	12	309
CXRS	5120-05-3600		R0.5	—	36	100	12	309
HMERS	6120-05-260	6 Flutes	R0.5	—	26	100	12	313
CRS40HSP	3120-050-30	3 Flutes	R0.5	30	15	75	12	569
HRRS	4120-05-36S	4 Flutes	R0.5	36	12	75	12	368
HRRS	4120-05-36		R0.5	36	12	120	12	363
CRRS	4120-05-36		R0.5	36	12	120	12	370
CXLRs	5120-05-36	5 Flutes	R0.5	36	24	80	12	381
HRRS	6120-05-370	6 Flutes	R0.5	37	12	100	12	384
CXLRs	5120-05-48	5 Flutes	R0.5	48	24	100	12	381
CRS40HSP	3120-050-54	3 Flutes	R0.5	54	15	120	12	569
HRRS	4120-05-60	4 Flutes	R0.5	60	12	120	12	363
C-CRS	2120-10	2 Flutes	R1	—	25	75	12	291
CXERS	4120-10-300	4 Flutes	R1	—	30	100	12	299
CNRS	4120-10-26		R1	—	26	120	12	294
CXRS	5120-10-2400	5 Flutes	R1	—	24	80	12	309
CXRS	5120-10-3600		R1	—	36	100	12	309
HMERS	6120-10-260	6 Flutes	R1	—	26	100	12	313
HRRS	4120-10-36S	4 Flutes	R1	36	12	75	12	368
HRRS	4120-10-36		R1	36	12	120	12	363
CRRS	4120-10-36		R1	36	12	120	12	370
CXLRs	5120-10-36	5 Flutes	R1	36	24	80	12	381
HRRS	6120-10-370	6 Flutes	R1	37	12	100	12	384
CXLRs	5120-10-48	5 Flutes	R1	48	24	100	12	381
HRRS	4120-10-60	4 Flutes	R1	60	12	120	12	363
CXERS	4120-12-300		R1.2	—	30	100	12	299
CRS20HSP	4120-120-30		R1.2	30	15	75	12	570
C-CRS	2120-15	2 Flutes	R1.5	—	25	75	12	291
CXERS	4120-15-300	4 Flutes	R1.5	—	30	100	12	299

12

Model Number	Number of Flutes	Outside Diameter	Corner Radius	Effective Length	Length of Cut	Overall Length	Shank Diameter	Page
CNRS	4120-15-26	4 Flutes	R1.5	—	26	120	12	294
CXRS	5120-15-2400	5 Flutes	R1.5	—	24	80	12	309
CXRS	5120-15-3600		R1.5	—	36	100	12	309
HMERS	6120-15-260	6 Flutes	R1.5	—	26	100	12	313
CXLRs	5120-15-36	5 Flutes	R1.5	36	24	80	12	381
CXLRs	5120-15-48		R1.5	48	24	100	12	381
C-CRS	2120-20	2 Flutes	R2	—	25	75	12	291
CXERS	4120-20-300	4 Flutes	R2	—	30	100	12	299
CNRS	4120-20-26	4 Flutes	R2	—	26	120	12	294
CXRS	5120-20-2400	5 Flutes	R2	—	24	80	12	309
CXRS	5120-20-3600		R2	—	36	100	12	309
HMERS	6120-20-260	6 Flutes	R2	—	26	100	12	313
HRRS	4120-20-36S	4 Flutes	R2	36	12	75	12	368
HRRS	4120-20-36		R2	36	12	120	12	363
CRRS	4120-20-36		R2	36	12	120	12	370
CXLRs	5120-20-36	5 Flutes	R2	36	24	80	12	381
CXLRs	5120-20-48		R2	48	24	100	12	381
HRRS	4120-20-60	4 Flutes	R2	60	12	120	12	363
C-CRS	2120-25	2 Flutes	R2.5	—	25	75	12	291
C-CRS	2120-30		R3	—	25	75	12	291
CXERS	4120-30-300	4 Flutes	R3	—	30	100	12	299
HRRS	4120-40-36S		R4	36	12	75	12	368
HRRS	4120-40-36		R4	36	12	120	12	363

12



Size R0.4~R1



UDCBH



Patent pending **NEW**

Material Applications (☆ Highly Recommended ◎ Recommended ○ Suggested)

Work Material																
Carbon Steels	Alloy Steels	Prehardened Steels	Hardened Steels			Cast Iron	Aluminum Alloys	Graphite	Copper	Plastics	Glass Filled Plastics	Titanium Alloys	Heat Resistant Alloys	Cemented Carbide	Hard Brittle (Non-Metallic) Materials	
			~55HRC	~60HRC	~70HRC											
S45C S55C	SK / SCM SUS	NAK HPM													☆	◎ *

* Hard Brittle (Non-Metallic) Materials: Ceramics (Alumina, Zirconia, etc.), Glasses and etc.

Features

High efficiency and long life Ball End Mills for milling cemented carbide.
 High-level treatment to reduce cutting resistance and mill at a high feed rate.
 Wear resistance improved drastically with optimized Diamond coating.
 Best for roughing and semi-finishing.

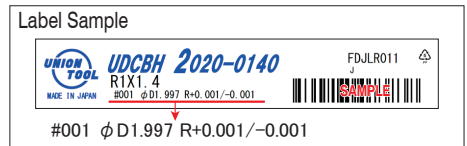
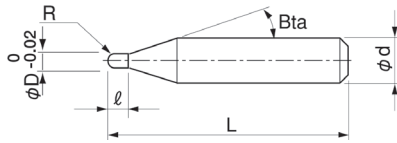

Diameter and Ball R accuracy measurements are printed on the label to support High Precision milling.

The shank taper angle shown is not an exact value and to avoid contact with the work piece, we recommend the user controls the precise value of this angle. Shank taper angle should not make contact with the work piece.

Total 4 models

Unit (mm)

Model Number	Radius of Ball Nose R	Length of Cut ℓ	Shank Taper Angle Bta	Overall Length L	Shank Diameter φd	Price ¥
UDCBH 2008-0056	R0.4	0.56	16°	50	4	44,160
UDCBH 2010-0070	R0.5	0.7	16°	50	4	44,160
UDCBH 2015-0105	R0.75	1.05	16°	50	4	44,160
UDCBH 2020-0140	R1	1.4	16°	50	4	44,160

Milling Conditions for UDCBH

WORK MATERIAL			CEMENTED CARBIDE (≥87HRA)					CEMENTED CARBIDE (<87HRA)					HARD BRITTLE MATERIALS				
Model Number	Radius of Ball Nose (mm)	Length of Cut (mm)	Spindle Speed (min ⁻¹)	Feed Rate (mm/min)	※ Feed Rate 2 (mm/min)	a_p Axial Depth (mm)	a_e Radial Depth (mm)	Spindle Speed (min ⁻¹)	Feed Rate (mm/min)	※ Feed Rate 2 (mm/min)	a_p Axial Depth (mm)	a_e Radial Depth (mm)	Spindle Speed (min ⁻¹)	Feed Rate (mm/min)	※ Feed Rate 2 (mm/min)	a_p Axial Depth (mm)	a_e Radial Depth (mm)
2008-0056	R0.4	0.56	30,000	750	250	0.04	0.19	30,000	1,250	420	0.19	0.04	30,000	250	25	0.04	0.19
2010-0070	R0.5	0.7	30,000	900	300	0.05	0.22	25,000	1,300	430	0.2	0.05	30,000	300	30	0.05	0.25
2015-0105	R0.75	1.05	30,000	1,200	400	0.075	0.27	19,000	1,450	480	0.23	0.07	24,000	400	45	0.075	0.27
2020-0140	R1	1.4	30,000	1,500	500	0.1	0.3	16,500	1,600	530	0.25	0.1	18,000	600	200	0.1	0.3

These milling parameters are based on VF-20, VM-40, VC-70, VU-70 (TAS standard) for Cemented Carbide, and Alumina for Hard Brittle Materials. These are for reference only.

Tool life may differ depending on the type of Cemented Carbide / Hard Brittle Materials.

For best result, fine parameter adjustments may be required, depending on the materials of Cemented Carbide / Hard Brittle Materials; milling shape and strategy; machine rigidity and spindle capability.

※ Feed Rate2: Feed Rate of Approach and *Connection links.
*Changing from one engagement point to the next.

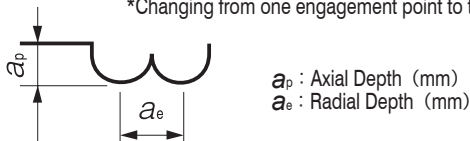

a_p : Axial Depth (mm)
 a_e : Radial Depth (mm)

- Note:
- This application requires a high cutting force. A machine with poor rigidity and high vibration is not recommended.
 - Allow sufficient machine and spindle warm-up time for stability and to remove any expansion of the main spindle before running the program.
 - Tool setting length should achieve the least possible overhang.
 - Avoid contact with the coated area of the shank. This will prevent tip vibration and tool jamming in the collet / holder.
 - Run-out and vibration should be checked dynamically at the tool point while mounted in the machine and both should achieve the lowest level possible.
 - Use an inclined or helical approach (Recommended inclination angle: <5 degree).
 - Decrease both spindle speed and feed rate proportionally.
 - Air blow is highly recommended for longer tool life. Both oil mist and oil coolant are alternatives.
 - Recommend water soluble coolant for Hard Brittle (Non-Metallic) Materials.
 - When milling some work pieces, heavier chips may be created. To evacuate these chips it is important to accurately position the coolant nozzle on the milling part.
 - Remove chips to prevent heat generation and ignition during milling process.
 - Protective gear, such as safety glasses and face guards are required when milling.
 - Chips / dust generated while milling can have adverse affects on the machine parts if they are not properly evacuated. Take steps to assure proper evacuation.
 - The tool life may shorten due to a large difference between the commanded feed speed and the actual machining speed caused by factors as machining model and machining machine.
 - Decrease both feed rate and feed rate 2 proportionally.
 - Tool damage may progress rapidly near the end of the tool life.

Refer to page 583-587 for features and milling examples of UDC series.

UDC Series

CBN Series

Square

Long Neck Square

Radius

Long Neck Radius

Taper Neck Radius

Ball / Long Shank Ball

Long Neck Ball

Taper Neck Ball

Taper

Spiral V Cutter

Drill

EURO Series

Technical Data



Size R0.1~R3



UDCBF



Patented in Japan

Material Applications (☆ Highly Recommended ◎ Recommended ○ Suggested)

Work Material																
Carbon Steels	Alloy Steels	Prehardened Steels	Hardened Steels			Cast Iron	Aluminum Alloys	Graphite	Copper	Plastics	Glass Filled Plastics	Titanium Alloys	Heat Resistant Alloys	Cemented Carbide	Hard Brittle (Non-Metallic) Materials	
			~55HRC	~60HRC	~70HRC											
S45C S55C	SK / SCM SUS	NAK HPM													☆	◎

* Hard Brittle (Non-Metallic) Materials: Ceramics (Alumina, Zirconia, etc.), Glasses and etc.

Features

Ball type End Mills for milling Cemented Carbide and Hard Brittle (Non-Metallic) Materials. Upgraded version of UDCB.

New Diamond coating and flute design increase material removal amount.

Chip pocket designed on tool tip improves the surface finishing quality.

Special cutting edge treatment helps to avoid the edge chipping & level gap. Recommended to use on semi-roughing & finishing process.

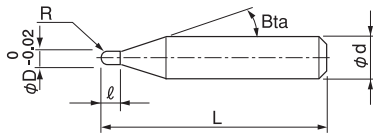

The shank taper angle shown is not an exact value and to avoid contact with the work piece, we recommend the user controls the precise value of this angle. Shank taper angle should not make contact with the work piece.

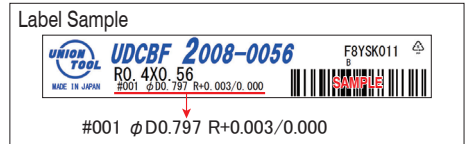

Diameter and Ball R accuracy measurements are printed on the label to support High Precision milling.

Total 16 models

Unit (mm)

Model Number	Radius of Ball Nose R	Length of Cut ℓ	Shank Taper Angle Bta	Overall Length L	Shank Diameter φd	Price ¥
UDCBF 2002-0014	R0.1	0.14	16°	50	4	47,000
UDCBF 2003-0021	R0.15	0.21	16°	50	4	47,000
UDCBF 2004-0028	R0.2	0.28	16°	50	4	42,800
UDCBF 2005-0035	R0.25	0.35	16°	50	4	42,800
UDCBF 2006-0042	R0.3	0.42	16°	50	4	38,400
UDCBF 2007-0049	R0.35	0.49	16°	50	4	38,400
UDCBF 2008-0056	R0.4	0.56	16°	50	4	38,400
UDCBF 2009-0063	R0.45	0.63	16°	50	4	38,400
UDCBF 2010-0070	R0.5	0.7	16°	50	4	38,400
UDCBF 2012-0084	R0.6	0.84	16°	50	4	38,400
UDCBF 2015-0105	R0.75	1.05	16°	50	4	38,400
UDCBF 2020-0140	R1	1.4	16°	50	4	38,400
UDCBF 2030-0210	R1.5	2.1	16°	60	6	42,300
UDCBF 2040-0280	R2	2.8	16°	60	6	42,300
UDCBF 2050-0350	R2.5	3.5	16°	60	6	42,300
UDCBF 2060-0420	R3	4.2	—	60	6	42,300

Milling Conditions for UDCBF

WORK MATERIAL			CEMENTED CARBIDE (≥87HRA) HARD BRITTLE MATERIALS						CEMENTED CARBIDE (<87HRA)				
Model Number	Radius of Ball Nose (mm)	Length of Cut (mm)	Spindle Speed (min ⁻¹)	Feed Rate (mm/min)	※Feed Rate 2 (mm/min)	a_p Axial Depth (mm)	a_e Radial Depth (mm)	Spindle Speed (min ⁻¹)	Feed Rate (mm/min)	※Feed Rate 2 (mm/min)	a_p Axial Depth (mm)	a_e Radial Depth (mm)	
2002-0014	R0.1	0.14	30,000	100	10	0.01	0.01	30,000	100	10	0.01	0.01	
2003-0021	R0.15	0.21	30,000	125	13	0.015	0.03	30,000	125	13	0.015	0.03	
2004-0028	R0.2	0.28	30,000	150	15	0.02	0.08	30,000	150	15	0.02	0.08	
2005-0035	R0.25	0.35	30,000	175	18	0.025	0.11	30,000	175	18	0.025	0.11	
2006-0042	R0.3	0.42	30,000	200	20	0.03	0.14	30,000	200	20	0.03	0.14	
2007-0049	R0.35	0.49	30,000	225	23	0.035	0.17	30,000	225	23	0.035	0.17	
2008-0056	R0.4	0.56	30,000	250	25	0.04	0.19	30,000	250	25	0.04	0.19	
2009-0063	R0.45	0.63	30,000	275	28	0.045	0.22	30,000	275	28	0.045	0.22	
2010-0070	R0.5	0.7	30,000	300	30	0.05	0.25	30,000	300	30	0.05	0.25	
2012-0084	R0.6	0.84	27,500	275	36	0.06	0.26	25,000	250	125	0.42	0.09	
2015-0105	R0.75	1.05	25,000	250	45	0.075	0.27	19,000	190	95	0.525	0.12	
2020-0140	R1	1.4	20,000	200	60	0.1	0.3	12,500	125	60	0.7	0.15	
2030-0210	R1.5	2.1	20,000	200	100	0.15	0.3	9,000	280	140	0.38	0.15	
2040-0280	R2	2.8	18,000	180	90	0.175	0.32	7,200	280	140	0.5	0.2	
2050-0350	R2.5	3.5	16,000	160	80	0.225	0.31	6,000	330	170	0.6	0.25	
2060-0420	R3	4.2	15,000	150	75	0.3	0.3	5,500	280	140	0.65	0.28	

These milling parameters are based on VF-20, VM-40, VC-70, VU-70 (TAS standard) for Cemented Carbide, and Alumina for Hard Brittle Materials. These are for reference only. Tool life may differ depending on the type of Cemented Carbide / Hard Brittle Materials.

For best result, fine parameter adjustments may be required, depending on the materials of Cemented Carbide / Hard Brittle Materials; milling shape and strategy; machine rigidity and spindle capability.

※ Feed Rate2: Approach feed rate and contact time on the surface

a_p : Axial Depth (mm)
 a_e : Radial Depth (mm)

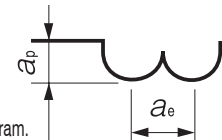

Note:

- This application requires a high cutting force. A machine with poor rigidity and high vibration is not recommended.
- Allow sufficient machine and spindle warm-up time for stability and to remove any expansion of the main spindle before running the program.
- Tool setting length should achieve the least possible overhang.
- Avoid contact with the coated area of the shank. This will prevent tip vibration and tool jamming in the collet / holder.
- Run-out and vibration should be checked dynamically at the tool point while mounted in the machine and both should achieve the lowest level possible.
- Use an inclined or helical approach (Recommended inclination angle: <5 degree).
- Decrease both spindle speed and feed rate proportionally.
- Air blow is highly recommended for longer tool life. Both oil mist and oil coolant are alternatives.
- Recommend water soluble coolant for Hard Brittle (Non-Metallic) Materials.
- When milling some work pieces, heavier chips may be created. To evacuate these chips it is important to accurately position the coolant nozzle on the milling part.
- Remove chips to prevent heat generation and ignition during milling process.
- Protective gear, such as safety glasses and face guards are required when milling.
- Chips / dust generated while milling can have adverse affects on the machine parts if they are not properly evacuated. Take steps to assure proper evacuation.

Cemented Carbide Indexable Insert Mold UDCBF R0.5×Length of Cut 0.7 VM-40(90HRA)

Tool	Surface Roughness	
	Roughing	Finishing
Tool	UDCBF 2010-0070	UDCBF 2010-0070
Spindle Speed	30,000 min ⁻¹	
Feed Rate	300 mm/min	
Axial Depth a_p	0.05 mm	0.028 mm
Radial Depth a_e	0.25 mm	0.02 mm
Coolant	Air Blow (Nozzle)	
Cycle Time	43 min	2 h 17 min
Material Removal Amount	86.3 mm ³	12.0 mm ³

One End Mill for both roughing and finishing processes.
Total 2 tools are used.

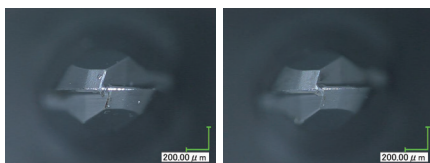

After roughing

After finishing

Refer to page 583-587 for features and milling examples of UDC series.

Surface Roughness

Excellent surface quality!

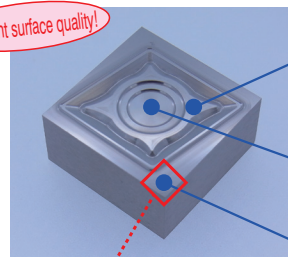

Ra:0.051 μm
Rz:0.399 μm

Ra:0.068 μm
Rz:0.520 μm

Ra:0.054 μm
Rz:0.408 μm

No edge chipping!

Work sample after finishing process

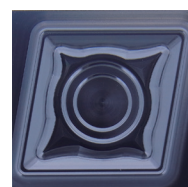
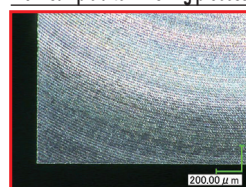

Size : 20 mm×20 mm×10 mm

UDCBF
Indexable Insert Mold
Milling Video



UDC Series

CBN Series

Square

Long Neck Square

Radius

Long Neck Radius

Taper Neck Radius

Ball / Long Shank Ball

Ball

Taper Neck Ball

Taper

Spiral V Cutter

Drill

EURO Series

Technical Data



Size R0.1~R3



UDCLBF

MG UDC 0° R ±0.01 Shank Dia 0/-0.005

Patented in Japan

Material Applications (☆ Highly Recommended ◎ Recommended ○ Suggested)

Work Material															
Carbon Steels	Alloy Steels	Prehardened Steels	Hardened Steels			Cast Iron	Aluminum Alloys	Graphite	Copper	Plastics	Glass Filled Plastics	Titanium Alloys	Heat Resistant Alloys	Cemented Carbide	Hard Brittle (Non-Metallic) Materials
S45C S55C	SK / SCM SUS	NAK HPM	~55HRC	~60HRC	~70HRC										
											○			☆	◎

* Hard Brittle (Non-Metallic) Materials: Ceramics (Alumina, Zirconia, etc.), Glasses and etc.

Features

Long Neck Ball type End Mills for milling Cemented Carbide and Hard Brittle (Non-Metallic) Materials. Upgraded version of UDCLB.

New Diamond coating and flute design increase material removal amount.

Chip pocket designed on tool tip improves the surface finishing quality.

Special cutting edge treatment helps to avoid the edge chipping & level gap.

Recommended to use on semi-roughing & finishing process.

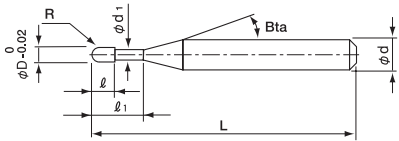
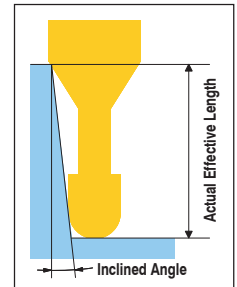

The shank taper angle shown is not an exact value and to avoid contact with the work piece, we recommend the user controls the precise value of this angle. Shank taper angle should not make contact with the work piece.



Diameter and Ball R accuracy measurements are printed on the label to support High Precision milling.

Total 61 models

Unit (mm)

Model Number	Radius of Ball Nose R	Effective Length ℓ ₁	Length of Cut ℓ	Neck Diameter φ _{d1}	Shank Taper Angle Bta	Overall Length L	Shank Diameter φ _d	Price ¥	Effective Length by Inclined Angles				
									30°	1°	1°30'	2°	3°
UDCLBF 2002-0030	R0.1	0.3	0.14	0.18	16°	50	4	47,500	0.30	0.31	0.32	0.32	0.34
UDCLBF 2002-0050		0.5							0.51	0.52	0.54	0.55	0.59
UDCLBF 2002-0075		0.75							0.77	0.79	0.81	0.84	0.89
UDCLBF 2002-0100		1							1.02	1.05	1.09	1.12	1.20
UDCLBF 2003-0050	R0.15	0.5	0.21	0.28	16°	50	4	47,500	0.51	0.52	0.53	0.55	0.58
UDCLBF 2003-0075		0.75							0.76	0.78	0.81	0.83	0.88
UDCLBF 2003-0100		1							1.02	1.05	1.08	1.11	1.19
UDCLBF 2004-0050	R0.2	0.5	0.28	0.36	16°	50	4	43,300	0.54	0.55	0.56	0.58	0.61
UDCLBF 2004-0100		1							1.06	1.08	1.12	1.15	1.22
UDCLBF 2004-0150		1.5							1.57	1.62	1.67	1.72	1.83
UDCLBF 2004-0200		2							2.09	2.15	2.22	2.29	2.44
UDCLBF 2004-0250		2.5							2.60	2.68	2.77	2.86	3.06

Model Number	Radius of Ball Nose R	Effective Length ℓ_1	Length of Cut ℓ	Neck Diameter ϕd_1	Shank Taper Angle Bia	Overall Length L	Shank Diameter ϕd	Price ¥	Effective Length by Inclined Angles				
									30°	1°	1°30'	2°	3°
UDCLBF 2006-0100	R0.3	1	0.42	0.56	16°	50	4	38,900	1.05	1.08	1.11	1.13	1.20
UDCLBF 2006-0150		1.5				50	4	38,900	1.57	1.61	1.66	1.70	1.81
UDCLBF 2006-0200		2				50	4	38,900	2.08	2.14	2.21	2.27	2.42
UDCLBF 2006-0300		3				50	4	38,900	3.12	3.21	3.31	3.41	3.65
UDCLBF 2006-0400		4				50	4	38,900	4.15	4.27	4.41	4.55	4.87
UDCLBF 2006-0500		5				50	4	38,900	5.18	5.34	5.51	5.69	6.09
UDCLBF 2006-0600	6	50	4	38,900	6.21	6.40	6.61	6.83	7.32				
UDCLBF 2008-0200	R0.4	2	0.56	0.76	16°	50	4	38,900	2.08	2.14	2.20	2.26	2.40
UDCLBF 2008-0300		3				50	4	38,900	3.11	3.20	3.30	3.40	3.62
UDCLBF 2008-0400		4				50	4	38,900	4.14	4.27	4.40	4.54	4.85
UDCLBF 2008-0500		5				50	4	38,900	5.18	5.33	5.50	5.67	6.07
UDCLBF 2008-0600		6				50	4	38,900	6.21	6.40	6.60	6.81	7.29
UDCLBF 2008-0800		8				50	4	38,900	8.27	8.53	8.80	9.09	9.74
UDCLBF 2010-0150	R0.5	1.5	0.7	0.96	16°	50	4	38,900	1.56	1.60	1.64	1.68	1.77
UDCLBF 2010-0200		2				50	4	38,900	2.08	2.13	2.19	2.25	2.38
UDCLBF 2010-0250		2.5				50	4	38,900	2.59	2.66	2.74	2.81	2.99
UDCLBF 2010-0300		3				50	4	38,900	3.11	3.20	3.29	3.38	3.60
UDCLBF 2010-0400		4				50	4	38,900	4.14	4.26	4.39	4.52	4.83
UDCLBF 2010-0600		6				50	4	38,900	6.20	6.39	6.59	6.80	7.27
UDCLBF 2010-0800	8	50	4	38,900	8.27	8.52	8.79	9.08	9.72				
UDCLBF 2010-1000	10	50	4	38,900	10.33	10.65	10.99	11.35	12.17				
UDCLBF 2015-0200	R0.75	2	1.05	1.44	16°	50	4	38,900	2.11	2.15	2.20	2.25	2.37
UDCLBF 2015-0400		4				50	4	38,900	4.17	4.28	4.40	4.53	4.81
UDCLBF 2015-0600		6				50	4	38,900	6.23	6.41	6.60	6.81	7.26
UDCLBF 2015-0800		8				50	4	38,900	8.29	8.54	8.80	9.08	9.71
UDCLBF 2015-1000		10				50	4	38,900	10.36	10.67	11.00	11.36	12.16
UDCLBF 2015-1200		12				50	4	38,900	12.42	12.80	13.20	13.64	14.60
UDCLBF 2020-0300	R1	3	1.4	1.9	16°	50	4	38,900	3.20	3.27	3.35	3.43	3.62
UDCLBF 2020-0400		4				50	4	38,900	4.23	4.34	4.45	4.57	4.84
UDCLBF 2020-0600		6				50	4	38,900	6.30	6.47	6.65	6.85	7.29
UDCLBF 2020-0800		8				50	4	38,900	8.36	8.60	8.85	9.13	9.74
UDCLBF 2020-1000		10				50	4	38,900	10.42	10.73	11.06	11.41	12.19
UDCLBF 2020-1200		12				50	4	38,900	12.48	12.86	13.26	13.68	14.63
UDCLBF 2020-1400		14				50	4	38,900	14.55	14.99	15.46	15.96	17.08
UDCLBF 2020-1600		16				50	4	38,900	16.61	17.12	17.66	18.24	19.53
UDCLBF 2020-1800		18				60	4	38,900	18.67	19.25	19.86	20.52	No Interference
UDCLBF 2020-2000		20				60	4	38,900	20.74	21.38	22.06	22.79	No Interference
UDCLBF 2030-0600	R1.5	6	2.1	2.9	16°	60	6	42,800	6.28	6.44	6.60	6.78	7.18
UDCLBF 2030-0800		8				60	6	42,800	8.34	8.57	8.80	9.06	9.63
UDCLBF 2030-1000		10				60	6	42,800	10.41	10.70	11.01	11.34	12.08
UDCLBF 2030-1200		12				60	6	42,800	12.47	12.83	13.21	13.61	14.52
UDCLBF 2030-1400		14				60	6	42,800	14.53	14.96	15.41	15.89	16.97
UDCLBF 2040-0800	R2	8	2.8	3.9	16°	60	6	42,800	8.33	8.53	8.76	8.99	9.52
UDCLBF 2040-1000		10				60	6	42,800	10.39	10.66	10.96	11.27	11.97
UDCLBF 2040-1500		15				60	6	42,800	15.55	15.99	16.46	16.96	18.09
UDCLBF 2050-1000	R2.5	10	3.5	4.8	16°	60	6	42,800	10.55	10.82	11.10	11.40	12.07
UDCLBF 2050-1500		15				60	6	42,800	15.71	16.14	16.60	17.09	No Interference
UDCLBF 2060-1000	R3	10	4.2	5.7	—	60	6	42,800	No Interference	No Interference	No Interference	No Interference	No Interference
UDCLBF 2060-1500		15				60	6	42,800	No Interference	No Interference	No Interference	No Interference	No Interference

UDC Series

CBN Series

Square

Square

Long Neck Square

Radius

Radius

Long Neck Radius

Taper Neck Radius

Ball / Long Shank Ball

Ball

Long Neck Ball

Taper Neck Ball

Taper

Taper

Spiral V Cutter

Drill

EURO Series

Technical Data

EURO Series

EURO Series

Technical Data

Milling Conditions for UDCLBF

WORK MATERIAL			CEMENTED CARBIDE (≥87HRA) / HARD BRITTLE MATERIALS					CEMENTED CARBIDE (<87HRA)					
Model Number	Radius of Ball Nose (mm)	Effective Length (mm)	Spindle Speed (min ⁻¹)	Feed Rate (mm/min)	**Feed Rate 2 (mm/min)	a _p Axial Depth (mm)	a _e Radial Depth (mm)	Spindle Speed (min ⁻¹)	Feed Rate (mm/min)	**Feed Rate 2 (mm/min)	a _p Axial Depth (mm)	a _e Radial Depth (mm)	
2002-0030	R0.1	0.3	30,000	100	10	0.01	0.01	30,000	100	10	0.01	0.01	
2002-0050		0.5	30,000	30	10	0.005	0.008	30,000	30	10	0.005	0.008	
2002-0075		0.75	30,000	30	10	0.005	0.006	30,000	30	10	0.005	0.006	
2002-0100		1	30,000	25	10	0.005	0.005	30,000	25	10	0.005	0.005	
2003-0050	R0.15	0.5	30,000	100	10	0.01	0.03	30,000	100	10	0.01	0.03	
2003-0075		0.75	30,000	80	10	0.01	0.02	30,000	80	10	0.01	0.02	
2003-0100		1	30,000	60	10	0.01	0.02	30,000	60	10	0.01	0.02	
2004-0050	R0.2	0.5	30,000	150	15	0.02	0.08	30,000	150	15	0.02	0.08	
2004-0100		1	30,000	100	10	0.015	0.07	30,000	100	10	0.015	0.07	
2004-0150		1.5	30,000	60	10	0.01	0.06	30,000	60	10	0.01	0.06	
2004-0200		2	30,000	30	10	0.008	0.05	30,000	30	10	0.008	0.05	
2004-0250	R0.3	2.5	30,000	15	10	0.006	0.03	30,000	15	10	0.006	0.03	
2006-0100		1	30,000	200	20	0.03	0.14	30,000	200	20	0.03	0.14	
2006-0150		1.5	30,000	200	20	0.03	0.14	30,000	200	20	0.03	0.14	
2006-0200		2	30,000	150	15	0.022	0.11	30,000	150	15	0.022	0.11	
2006-0300		3	30,000	75	10	0.01	0.08	30,000	75	10	0.01	0.08	
2006-0400		4	30,000	75	10	0.01	0.08	30,000	75	10	0.01	0.08	
2006-0500		5	30,000	75	10	0.01	0.06	30,000	75	10	0.01	0.06	
2006-0600		6	30,000	75	10	0.01	0.03	30,000	75	10	0.01	0.03	
2008-0200		R0.4	2	30,000	250	25	0.04	0.19	30,000	250	25	0.04	0.19
2008-0300			3	30,000	230	23	0.037	0.17	30,000	230	23	0.037	0.17
2008-0400	4		30,000	210	21	0.035	0.16	30,000	210	21	0.035	0.16	
2008-0500	5		25,000	170	20	0.03	0.12	25,000	170	20	0.03	0.12	
2008-0600	R0.5	6	20,000	130	20	0.025	0.08	20,000	130	20	0.025	0.08	
2008-0800		8	15,000	100	20	0.015	0.03	15,000	100	20	0.015	0.03	
2010-0150		1.5	30,000	300	30	0.05	0.25	30,000	300	150	0.35	0.075	
2010-0200		2	30,000	300	30	0.05	0.25	30,000	300	150	0.35	0.075	
2010-0250		2.5	30,000	300	30	0.05	0.25	30,000	300	150	0.35	0.075	
2010-0300		3	30,000	300	30	0.05	0.25	25,000	250	125	0.35	0.075	
2010-0400	4	30,000	300	30	0.05	0.25	25,000	250	125	0.2	0.1		
2010-0600	R0.75	6	25,000	250	25	0.04	0.15	25,000	250	125	0.1	0.1	
2010-0800		8	20,000	200	25	0.025	0.07	20,000	200	100	0.03	0.08	
2010-1000		10	10,000	100	20	0.018	0.03	20,000	200	100	0.02	0.04	
2015-0200		2	25,000	250	45	0.075	0.27	18,000	180	90	0.52	0.12	
2015-0400	R1	4	25,000	250	45	0.075	0.27	18,000	180	90	0.52	0.12	
2015-0600		6	25,000	250	45	0.075	0.27	18,000	180	90	0.4	0.12	
2015-0800		8	20,000	160	30	0.075	0.27	18,000	180	90	0.2	0.2	
2015-1000		10	20,000	130	30	0.05	0.15	18,000	180	90	0.075	0.25	
2015-1200		12	16,000	100	30	0.03	0.08	13,500	135	70	0.05	0.16	
2020-0300		3	20,000	200	60	0.1	0.3	12,500	125	60	0.7	0.15	
2020-0400	R1	4	20,000	200	60	0.1	0.3	12,500	125	60	0.7	0.15	
2020-0600		6	20,000	200	60	0.1	0.3	12,500	125	60	0.7	0.15	
2020-0800		8	20,000	200	60	0.1	0.3	12,500	125	60	0.4	0.2	
2020-1000		10	20,000	200	60	0.1	0.3	12,500	125	60	0.25	0.25	
2020-1200		12	20,000	200	60	0.09	0.25	12,500	125	60	0.1	0.3	
2020-1400		14	20,000	200	60	0.07	0.15	12,500	125	60	0.1	0.3	
2020-1600		16	13,000	130	36	0.04	0.08	12,500	125	60	0.1	0.3	
2020-1800		18	10,000	100	30	0.025	0.05	10,000	100	50	0.04	0.1	
2020-2000		20	10,000	100	30	0.02	0.035	10,000	100	50	0.02	0.07	

- UDC Series
- CBN Series
- Square
- Long Neck Square
- Radius
- Long Neck Radius
- Taper Neck Radius
- Ball / Long Shark Ball
- Long Neck Ball
- Taper Neck Ball
- Taper
- Spiral V Cutter
- Drill
- EURO Series
- Technical Data

Milling Conditions for UDCLBF

WORK MATERIAL			CEMENTED CARBIDE (≥87HRA) / HARD BRITTLE MATERIALS					CEMENTED CARBIDE (<87HRA)				
Model Number	Radius of Ball Nose (mm)	Effective Length (mm)	Spindle Speed (min ⁻¹)	Feed Rate (mm/min)	※Feed Rate 2 (mm/min)	a_p Axial Depth (mm)	a_e Radial Depth (mm)	Spindle Speed (min ⁻¹)	Feed Rate (mm/min)	※Feed Rate 2 (mm/min)	a_p Axial Depth (mm)	a_e Radial Depth (mm)
2030-0600	R1.5	6	20,000	200	100	0.15	0.3	9,000	280	140	0.38	0.15
2030-0800		8	20,000	200	100	0.15	0.3	9,000	280	140	0.38	0.15
2030-1000		10	20,000	200	100	0.15	0.3	9,000	280	140	0.38	0.15
2030-1200		12	20,000	200	100	0.15	0.3	9,000	280	140	0.38	0.15
2030-1400		14	20,000	200	100	0.15	0.3	9,000	280	140	0.38	0.15
2040-0800	R2	8	18,000	180	90	0.175	0.32	7,200	280	140	0.5	0.2
2040-1000		10	18,000	180	90	0.175	0.32	7,200	280	140	0.5	0.2
2040-1500		15	18,000	180	90	0.175	0.32	7,200	280	140	0.5	0.2
2050-1000	R2.5	10	16,000	160	80	0.225	0.31	6,000	330	170	0.6	0.25
2050-1500		15	16,000	160	80	0.225	0.31	6,000	330	170	0.6	0.25
2060-1000	R3	10	15,000	150	75	0.3	0.3	5,500	280	140	0.65	0.28
2060-1500		15	15,000	150	75	0.3	0.3	5,500	280	140	0.65	0.28

These milling parameters are based on VF-20, VM-40, VC-70, VU-70 (TAS standard) for Cemented Carbide, and Alumina for Hard Brittle Materials. These are for reference only.

Tool life may differ depending on the type of Cemented Carbide / Hard Brittle Materials.

For best result, fine parameter adjustments may be required, depending on the materials of Cemented Carbide / Hard Brittle Materials; milling shape and strategy; machine rigidity and spindle capability.

※ Feed Rate 2: Approach feed rate and contact time on the surface.

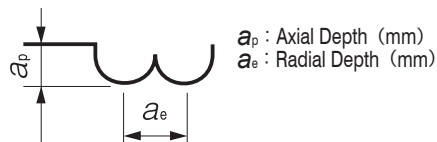

Note:

- This application requires a high cutting force. A machine with poor rigidity and high vibration is not recommended.
- Allow sufficient machine and spindle warm-up time for stability and to remove any expansion of the main spindle before running the program.
- Tool setting length should achieve the least possible overhang.
- Avoid contact with the coated area of the shank. This will prevent tip vibration and tool jamming in the collet / holder.
- Run-out and vibration should be checked dynamically at the tool point while mounted in the machine and both should achieve the lowest level possible.
- Use an inclined or helical approach (Recommended inclination angle: <5 degree).
- Decrease both spindle speed and feed rate proportionally.
- Air blow is highly recommended for longer tool life. Both oil mist and oil coolant are alternatives.
- Recommend water soluble coolant for Hard Brittle (Non-Metallic) Materials.
- When milling some work pieces, heavier chips may be created. To evacuate these chips it is important to accurately position the coolant nozzle on the milling part.
- Remove chips to prevent heat generation and ignition during milling process.
- Protective gear, such as safety glasses and face guards are required when milling.
- Chips / dust generated while milling can have adverse affects on the machine parts if they are not properly evacuated. Take steps to assure proper evacuation.

Refer to page 583-587 for features and milling examples of UDC series.

UDC Series

CBN Series

Square

Long Neck Square

Radius

Long Neck Radius

Taper Neck Radius

Ball / Long Shank Ball

Long Neck Ball

Taper Neck Ball

Taper

Spiral V Cutter

Drill

EURO Series

Technical Data



Size $\phi 0.3 \sim \phi 2$ UDC

UDCLRSF



Patented in Japan

Material Applications (☆ Highly Recommended ● Recommended ○ Suggested)

Work Material																
Carbon Steels S45C S55C	Alloy Steels SK / SCM SUS	Prehardened Steels NAK HPM	Hardened Steels			Cast Iron	Aluminum Alloys	Graphite	Copper	Plastics	Glass Filled Plastics	Titanium Alloys	Heat Resistant Alloys	Cemented Carbide	Hard Brittle (Non-Metallic) Materials	
			~55HRC	~60HRC	~70HRC											
														○	☆	● *

* Hard Brittle (Non-Metallic) Materials: Ceramics (Alumina, Zirconia, etc.), Glasses and etc.

- UDC Series
- CBN Series
- Square
- Long Neck Square
- Radius
- Long Neck Radius
- Taper Neck Radius
- Ball / Long Shank Ball
- Long Neck Ball
- Taper Neck Ball
- Taper
- Spiral V Cutter
- Drill
- EURO Series
- Technical Data

Total 52 models

Unit (mm)

Model Number	Outside Diameter ϕD	Corner Radius CR	Effective Length ℓ_1	Length of Cut ℓ	Neck Diameter ϕd_1	Shank Taper Angle Bta	Overall Length L	Shank Diameter ϕd	Price ¥				
UDCLRSF 2003-003006	0.3	RO.03	0.6	0.15	0.28	16°	50	4	54,600				
UDCLRSF 2003-005006		RO.05	0.6				50	4	54,600				
UDCLRSF 2005-003005	0.5	RO.03	0.5	0.25	0.46	16°	50	4	52,000				
UDCLRSF 2005-003010			1				50	4	52,000				
UDCLRSF 2005-003015			1.5				50	4	52,000				
UDCLRSF 2005-005005			0.5				50	4	52,000				
UDCLRSF 2005-005010		RO.05	1				50	4	52,000				
UDCLRSF 2005-005015			1.5				50	4	52,000				
UDCLRSF 2008-003008			RO.03				0.8	0.4	0.76	16°	50	4	46,700
UDCLRSF 2008-003016							1.6				50	4	46,700
UDCLRSF 2008-003024	2.4	50		4	46,700								
UDCLRSF 2008-005008	RO.05	0.8	50	4	46,700								
UDCLRSF 2008-005016		1.6	50	4	46,700								
UDCLRSF 2008-005024		2.4	50	4	46,700								
UDCLRSF 2008-010008		RO.1	0.8	50	4	46,700							
UDCLRSF 2008-010016			1.6	50	4	46,700							
UDCLRSF 2008-010024			2.4	50	4	46,700							
UDCLRSF 2008-010024	2.4		50	4	46,700								

Features

Long Neck Radius End Mills for milling Cemented Carbide & Hard Brittle (Non-Metallic) Materials.
 Upgraded version of UDCLRS.
 Improved Diamond coating and optimum cutting geometries will "deep cuts" the material with offering long tool life.
 Special cutting edge treatment helps to avoid the edge chipping & level gap on the work piece.
 Recommended to use on semi-roughing & finishing process.

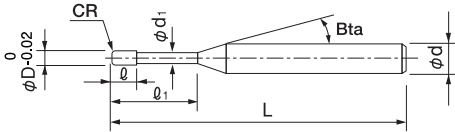
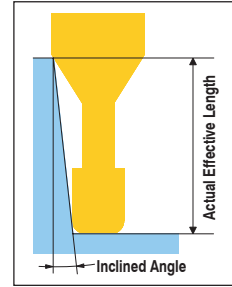

Diameter and Corner R accuracy measurements are printed on the label to support High Precision milling.

The shank taper angle shown is not an exact value and to avoid contact with the workpiece, we recommend the user controls the precise value of this angle. Shank taper angle should not make contact with the work piece.

Unit (mm)

Model Number	Outside Diameter ϕD	Corner Radius CR	Effective Length ϕ_1	Effective Length by Inclined Angles				
				30'	1°	1° 30'	2°	3°
UDCLRSF 2003-003006	0.3	RO.03	0.6	0.61	0.63	0.65	0.67	0.72
UDCLRSF 2003-005006		RO.05	0.6	0.61	0.63	0.65	0.67	0.72
UDCLRSF 2005-003005	0.5	RO.03	0.5	0.55	0.56	0.58	0.60	0.64
UDCLRSF 2005-003010			1	1.06	1.10	1.13	1.17	1.25
UDCLRSF 2005-003015		1.5	1.58	1.63	1.68	1.74	1.87	
UDCLRSF 2005-005005		RO.05	0.5	0.55	0.56	0.58	0.60	0.64
UDCLRSF 2005-005010			1	1.06	1.09	1.13	1.17	1.25
UDCLRSF 2005-005015			1.5	1.58	1.63	1.68	1.74	1.86
UDCLRSF 2008-003008			RO.03	0.8	0.86	0.88	0.91	0.94
UDCLRSF 2008-003016		1.6		1.68	1.73	1.79	1.85	1.99
UDCLRSF 2008-003024	2.4	2.51		2.59	2.67	2.76	2.97	
UDCLRSF 2008-005008	RO.05	0.8		0.85	0.88	0.91	0.94	1.01
UDCLRSF 2008-005016		1.6		1.68	1.73	1.79	1.85	1.98
UDCLRSF 2008-005024		2.4		2.50	2.58	2.67	2.76	2.96
UDCLRSF 2008-010008	RO.1	0.8	0.85	0.88	0.90	0.93	0.99	
UDCLRSF 2008-010016		1.6	1.68	1.73	1.78	1.84	1.97	
UDCLRSF 2008-010024		2.4	2.50	2.58	2.66	2.75	2.95	

Next Page ➡

UDC Series

CBN Series

Square

Long Neck Square

Radius

Long Neck Radius

Taper Neck Radius

Ball / Long Shank Ball

Long Neck Ball

Taper Neck Ball

Taper

Spiral V Cutter

Drill

EURO Series

Technical Data

2 Flutes High-grade UDC for Cemented Carbide and Hard Brittle Material Milling

Unit (mm)

Model Number	Outside Diameter ϕD	Corner Radius CR	Effective Length ℓ_1	Length of Cut ℓ	Neck Diameter ϕd_1	Shank Taper Angle Bta	Overall Length L	Shank Diameter ϕd	Price ¥
UDCLRSF 2010-003010	1	RO.03	1	0.5	0.96	16°	50	4	46,700
UDCLRSF 2010-003020			2				50	4	46,700
UDCLRSF 2010-003040			4				50	4	46,700
UDCLRSF 2010-003060			6				50	4	46,700
UDCLRSF 2010-005010		RO.05	1				50	4	46,700
UDCLRSF 2010-005020			2				50	4	46,700
UDCLRSF 2010-005040			4				50	4	46,700
UDCLRSF 2010-005060			6				50	4	46,700
UDCLRSF 2010-010010		RO.1	1				50	4	46,700
UDCLRSF 2010-010020			2				50	4	46,700
UDCLRSF 2010-010040			4				50	4	46,700
UDCLRSF 2010-010060			6				50	4	46,700
UDCLRSF 2015-003015	1.5	RO.03	1.5	0.75	1.44	16°	50	4	46,700
UDCLRSF 2015-003030			3				50	4	46,700
UDCLRSF 2015-005015		RO.05	1.5				50	4	46,700
UDCLRSF 2015-005030			3				50	4	46,700
UDCLRSF 2015-010015		RO.1	1.5				50	4	46,700
UDCLRSF 2015-010030			3				50	4	46,700
UDCLRSF 2015-010040			4				50	4	46,700
UDCLRSF 2015-010060			6				50	4	46,700
UDCLRSF 2020-003020	2	RO.03	2	1	1.9	16°	50	4	46,700
UDCLRSF 2020-003040			4				50	4	46,700
UDCLRSF 2020-003060			6				50	4	46,700
UDCLRSF 2020-003080			8				50	4	46,700
UDCLRSF 2020-003100			10				50	4	46,700
UDCLRSF 2020-005020			RO.05				2	50	4
UDCLRSF 2020-005040		4					50	4	46,700
UDCLRSF 2020-005060		6					50	4	46,700
UDCLRSF 2020-005080		8					50	4	46,700
UDCLRSF 2020-005100		10					50	4	46,700
UDCLRSF 2020-010020		RO.1					2	50	4
UDCLRSF 2020-010040			4				50	4	46,700
UDCLRSF 2020-010060			6				50	4	46,700
UDCLRSF 2020-010080			8				50	4	46,700
UDCLRSF 2020-010100			10				50	4	46,700

UDC Series

CBN Series

Square
Long Neck Square

Radius
Long Neck Radius
Taper Neck Radius

Ball / Long Shank Ball
Long Neck Ball
Taper Neck Ball

Taper

Spiral V Cutter

Drill

EURO Series

Technical Data

Model Number	Outside Diameter ϕD	Corner Radius CR	Effective Length ℓ_1	Effective Length by Inclined Angles					
				30'	1°	1° 30'	2°	3°	
UDCLRSF 2010-003010	1	RO.03	1	1.06	1.10	1.13	1.17	1.25	
UDCLRSF 2010-003020			2	2.09	2.16	2.23	2.31	2.48	
UDCLRSF 2010-003040			4	4.16	4.29	4.43	4.59	4.93	
UDCLRSF 2010-003060			6	6.22	6.42	6.63	6.86	7.37	
UDCLRSF 2010-005010		RO.05	1	1.06	1.09	1.13	1.17	1.25	
UDCLRSF 2010-005020			2	2.09	2.16	2.23	2.31	2.47	
UDCLRSF 2010-005040			4	4.15	4.29	4.43	4.58	4.92	
UDCLRSF 2010-005060			6	6.22	6.42	6.63	6.86	7.37	
UDCLRSF 2010-010010		RO.1	1	1.06	1.09	1.12	1.16	1.24	
UDCLRSF 2010-010020			2	2.09	2.16	2.22	2.30	2.46	
UDCLRSF 2010-010040			4	4.15	4.28	4.43	4.58	4.91	
UDCLRSF 2010-010060			6	6.22	6.41	6.63	6.85	7.36	
UDCLRSF 2015-003015	1.5	RO.03	1.5	1.61	1.66	1.72	1.78	1.91	
UDCLRSF 2015-003030			3	3.16	3.26	3.37	3.49	3.74	
UDCLRSF 2015-005015		RO.05	1.5	1.61	1.66	1.72	1.78	1.90	
UDCLRSF 2015-005030			3	3.16	3.26	3.37	3.48	3.74	
UDCLRSF 2015-010015		RO.1	1.5	1.61	1.66	1.71	1.77	1.89	
UDCLRSF 2015-010030			3	3.16	3.26	3.36	3.48	3.73	
UDCLRSF 2015-010040			4	4.19	4.32	4.46	4.62	4.95	
UDCLRSF 2015-010060			6	6.25	6.45	6.66	6.89	7.40	
UDCLRSF 2020-003020		2	RO.03	2	2.20	2.27	2.35	2.43	2.61
UDCLRSF 2020-003040				4	4.26	4.40	4.55	4.70	5.05
UDCLRSF 2020-003060	6			6.33	6.53	6.75	6.98	7.50	
UDCLRSF 2020-003080	8			8.39	8.66	8.95	9.26	9.95	
UDCLRSF 2020-003100	10			10.45	10.79	11.15	11.54	12.40	
UDCLRSF 2020-005020	RO.05		2	2.20	2.27	2.34	2.42	2.60	
UDCLRSF 2020-005040			4	4.26	4.40	4.55	4.70	5.05	
UDCLRSF 2020-005060			6	6.33	6.53	6.75	6.98	7.50	
UDCLRSF 2020-005080			8	8.39	8.66	8.95	9.26	9.94	
UDCLRSF 2020-005100			10	10.45	10.79	11.15	11.53	12.39	
UDCLRSF 2020-010020	RO.1		2	2.20	2.27	2.34	2.42	2.59	
UDCLRSF 2020-010040			4	4.26	4.40	4.54	4.69	5.04	
UDCLRSF 2020-010060			6	6.32	6.53	6.74	6.97	7.49	
UDCLRSF 2020-010080			8	8.39	8.66	8.94	9.25	9.93	
UDCLRSF 2020-010100			10	10.45	10.79	11.14	11.53	12.38	

UDC Series

CBN Series

Square

Long Neck Square

Radius

Long Neck Radius

Taper Neck Radius

Ball / Long Shank Ball

Long Neck Ball

Taper Neck Ball

Taper

Spiral V Cutter

Drill

EURO Series

Technical Data

Milling Conditions for UDCLRSF

WORK MATERIAL	CEMENTED CARBIDE(≥87HRA) / HARD BRITTLE MATERIALS													
	Model Number	Spindle Speed (min ⁻¹)	Z-Level Milling				Flat Milling			Side Milling			Slotting	
Feed Rate (mm/min)			※Feed Rate 2 (mm/min)	a _p Axial Depth (mm)	a _e Radial Depth (mm)	Feed Rate (mm/min)	a _p Axial Depth (mm)	a _e Radial Depth (mm)	Feed Rate (mm/min)	a _p Axial Depth (mm)	a _e Radial Depth (mm)	Feed Rate (mm/min)	a _p Axial Depth (mm)	
2003-003006	30,000	220	50	0.015	0.2	220	0.015	0.2	110	0.075	0.006	110	0.015	
2003-005006	30,000	220	50	0.02	0.2	220	0.02	0.2	110	0.075	0.006	110	0.02	
2005-003005	30,000	190	90	0.02	0.4	190	0.02	0.4	180	0.25	0.01	190	0.02	
2005-003010	30,000	190	90	0.02	0.4	190	0.02	0.4	180	0.125	0.01	190	0.02	
2005-003015	30,000	140	65	0.015	0.3	140	0.015	0.3	130	0.125	0.007	140	0.015	
2005-005005	30,000	190	125	0.02	0.4	190	0.02	0.4	180	0.25	0.01	190	0.02	
2005-005010	30,000	190	125	0.02	0.4	190	0.02	0.4	180	0.125	0.01	190	0.02	
2005-005015	30,000	140	65	0.015	0.3	140	0.015	0.3	130	0.125	0.007	140	0.015	
2008-003008	30,000	190	90	0.02	0.6	190	0.02	0.6	300	0.4	0.016	190	0.02	
2008-003016	30,000	190	90	0.02	0.6	190	0.02	0.6	300	0.2	0.01	190	0.02	
2008-003024	30,000	175	80	0.018	0.5	175	0.018	0.5	275	0.2	0.007	175	0.018	
2008-005008	30,000	190	150	0.025	0.6	190	0.025	0.6	300	0.4	0.016	190	0.025	
2008-005016	30,000	190	150	0.025	0.6	190	0.025	0.6	300	0.2	0.01	190	0.025	
2008-005024	30,000	175	80	0.023	0.5	175	0.023	0.5	275	0.2	0.007	175	0.023	
2008-010008	30,000	190	150	0.03	0.6	190	0.03	0.6	300	0.4	0.016	190	0.03	
2008-010016	30,000	190	150	0.03	0.6	190	0.03	0.6	300	0.2	0.01	190	0.03	
2008-010024	30,000	175	80	0.028	0.5	175	0.028	0.5	275	0.2	0.007	175	0.028	
2010-003010	30,000	190	90	0.02	0.8	190	0.02	0.8	375	0.5	0.02	190	0.02	
2010-003020	30,000	190	90	0.02	0.8	190	0.02	0.8	375	0.25	0.01	190	0.02	
2010-003040	30,000	190	90	0.016	0.6	190	0.016	0.6	375	0.25	0.005	190	0.016	
2010-003060	25,000	155	75	0.01	0.5	155	0.01	0.5	300	0.25	0.005	155	0.01	
2010-005010	30,000	190	185	0.025	0.8	190	0.025	0.8	375	0.5	0.02	190	0.025	
2010-005020	30,000	190	185	0.025	0.8	190	0.025	0.8	375	0.25	0.01	190	0.025	
2010-005040	30,000	190	185	0.02	0.6	190	0.02	0.6	375	0.25	0.005	190	0.02	
2010-005060	25,000	155	150	0.012	0.5	155	0.012	0.5	300	0.25	0.005	155	0.012	
2010-010010	30,000	190	185	0.03	0.8	190	0.03	0.8	375	0.5	0.02	190	0.03	
2010-010020	30,000	190	185	0.03	0.8	190	0.03	0.8	375	0.25	0.01	190	0.03	
2010-010040	30,000	190	185	0.025	0.6	190	0.025	0.6	375	0.25	0.005	190	0.025	
2010-010060	25,000	155	150	0.015	0.5	155	0.015	0.5	300	0.25	0.005	155	0.015	
2015-003015	25,000	190	90	0.03	1.3	190	0.03	1.3	375	0.75	0.02	190	0.03	
2015-003030	25,000	190	90	0.03	1.3	190	0.03	1.3	375	0.375	0.01	190	0.03	
2015-005015	25,000	190	125	0.04	1.3	190	0.04	1.3	375	0.75	0.02	190	0.04	
2015-005030	25,000	190	125	0.04	1.3	190	0.04	1.3	375	0.375	0.01	190	0.04	
2015-010015	25,000	190	150	0.045	1.3	190	0.045	1.3	375	0.75	0.02	190	0.045	
2015-010030	25,000	190	150	0.045	1.3	190	0.045	1.3	375	0.375	0.01	190	0.045	
2015-010040	25,000	190	150	0.043	1.2	190	0.043	1.2	350	0.375	0.008	190	0.043	
2015-010060	25,000	190	150	0.04	1	190	0.04	1	350	0.375	0.005	190	0.04	

UDC Series

CBN Series

Square
Long Neck Square

Radius
Long Neck Radius

Ball / Long Shark Ball
Long Neck Ball

Taper Neck Ball

Taper

Spiral V Cutter

Drill
EURO Series
Technical Data

Milling Conditions for UDCLRSF

WORK MATERIAL		CEMENTED CARBIDE (<87HRA)											
Model Number	Spindle Speed (min ⁻¹)	Z-Level Milling				Flat Milling			Side Milling			Slotting	
		Feed Rate (mm/min)	※Feed Rate 2 (mm/min)	a _p Axial Depth (mm)	a _e Radial Depth (mm)	Feed Rate (mm/min)	a _p Axial Depth (mm)	a _e Radial Depth (mm)	Feed Rate (mm/min)	a _p Axial Depth (mm)	a _e Radial Depth (mm)	Feed Rate (mm/min)	a _p Axial Depth (mm)
2003-003006	21,000	300	50	0.015	0.2	300	0.015	0.2	200	0.075	0.003	300	0.015
2003-005006	21,000	300	50	0.02	0.2	300	0.02	0.2	200	0.075	0.003	300	0.02
2005-003005	16,000	500	160	0.02	0.4	500	0.02	0.4	800	0.25	0.005	500	0.02
2005-003010	16,000	500	160	0.02	0.4	500	0.02	0.4	400	0.125	0.005	500	0.02
2005-003015	16,000	375	120	0.014	0.3	375	0.014	0.3	300	0.125	0.005	375	0.014
2005-005005	16,000	500	160	0.025	0.4	500	0.025	0.4	800	0.25	0.005	500	0.025
2005-005010	16,000	500	160	0.025	0.4	500	0.025	0.4	400	0.125	0.005	500	0.025
2005-005015	16,000	375	120	0.017	0.3	375	0.017	0.3	300	0.125	0.005	375	0.017
2008-003008	13,000	390	130	0.02	0.6	390	0.02	0.6	1,200	0.4	0.008	390	0.02
2008-003016	13,000	390	130	0.02	0.6	390	0.02	0.6	600	0.2	0.008	390	0.02
2008-003024	13,000	350	120	0.014	0.5	350	0.014	0.5	540	0.2	0.006	350	0.014
2008-005008	13,000	390	130	0.025	0.6	390	0.025	0.6	1,200	0.4	0.008	390	0.025
2008-005016	13,000	390	130	0.025	0.6	390	0.025	0.6	600	0.2	0.008	390	0.025
2008-005024	13,000	350	120	0.017	0.5	350	0.017	0.5	540	0.2	0.006	350	0.017
2008-010008	13,000	390	130	0.03	0.6	390	0.03	0.6	1,200	0.4	0.008	390	0.03
2008-010016	13,000	390	130	0.03	0.6	390	0.03	0.6	600	0.2	0.008	390	0.03
2008-010024	13,000	350	120	0.02	0.5	350	0.02	0.5	540	0.2	0.006	350	0.02
2010-003010	12,000	360	120	0.02	0.8	360	0.02	0.8	1,440	0.5	0.01	360	0.02
2010-003020	12,000	360	120	0.02	0.8	360	0.02	0.8	720	0.25	0.01	360	0.02
2010-003040	10,000	300	100	0.012	0.7	300	0.012	0.7	600	0.25	0.008	300	0.012
2010-003060	10,000	300	100	0.008	0.7	300	0.008	0.7	600	0.25	0.006	300	0.008
2010-005010	12,000	360	120	0.025	0.8	360	0.025	0.8	1,440	0.5	0.01	360	0.025
2010-005020	12,000	360	120	0.025	0.8	360	0.025	0.8	720	0.25	0.01	360	0.025
2010-005040	10,000	300	100	0.015	0.7	300	0.015	0.7	600	0.25	0.008	300	0.015
2010-005060	10,000	300	100	0.01	0.7	300	0.01	0.7	600	0.25	0.006	300	0.01
2010-010010	12,000	360	120	0.03	0.8	360	0.03	0.8	1,440	0.5	0.01	360	0.03
2010-010020	12,000	360	120	0.03	0.8	360	0.03	0.8	720	0.25	0.01	360	0.03
2010-010040	10,000	300	100	0.02	0.7	300	0.02	0.7	600	0.25	0.008	300	0.02
2010-010060	10,000	300	100	0.012	0.7	300	0.012	0.7	600	0.25	0.006	300	0.012
2015-003015	11,000	330	110	0.03	1.3	330	0.03	1.3	1,440	0.75	0.01	330	0.03
2015-003030	11,000	330	110	0.03	1.3	330	0.03	1.3	720	0.375	0.01	330	0.03
2015-005015	11,000	330	110	0.04	1.3	330	0.04	1.3	1,440	0.75	0.01	330	0.04
2015-005030	11,000	330	110	0.04	1.3	330	0.04	1.3	720	0.375	0.01	330	0.04
2015-010015	11,000	330	110	0.045	1.3	330	0.045	1.3	1,440	0.75	0.01	330	0.045
2015-010030	11,000	330	110	0.045	1.3	330	0.045	1.3	720	0.375	0.01	330	0.045
2015-010040	11,000	330	110	0.045	1.1	330	0.045	1.1	720	0.375	0.01	330	0.045
2015-010060	11,000	330	110	0.03	1.1	330	0.03	1.1	720	0.375	0.009	330	0.03

UDC Series

CBN Series

Square

Long Neck Square

Radius

Long Neck Radius

Taper Neck Radius

Ball / Long Shank Ball

Long Neck Ball

Taper Neck Ball

Taper

Spiral V Cutter

Drill

EURO Series

Technical Data

Milling Conditions for UDCLRSF

WORK MATERIAL	CEMENTED CARBIDE($\geq 87\text{HRA}$) / HARD BRITTLE MATERIALS													
	Model Number	Spindle Speed (min ⁻¹)	Z-Level Milling				Flat Milling			Side Milling			Slotting	
Feed Rate (mm/min)			※Feed Rate 2 (mm/min)	a _p Axial Depth (mm)	a _e Radial Depth (mm)	Feed Rate (mm/min)	a _p Axial Depth (mm)	a _e Radial Depth (mm)	Feed Rate (mm/min)	a _p Axial Depth (mm)	a _e Radial Depth (mm)	Feed Rate (mm/min)	a _p Axial Depth (mm)	
2020-003020	20,000	190	90	0.04	1.8	190	0.04	1.8	375	1	0.02	190	0.04	
2020-003040	20,000	190	90	0.04	1.8	190	0.04	1.8	375	0.5	0.01	190	0.04	
2020-003060	20,000	190	90	0.037	1.7	190	0.037	1.7	325	0.5	0.007	190	0.037	
2020-003080	20,000	190	90	0.03	1.5	190	0.03	1.5	325	0.5	0.005	190	0.03	
2020-003100	20,000	190	90	0.025	1.3	190	0.025	1.3	300	0.5	0.005	190	0.025	
2020-005020	20,000	190	90	0.05	1.8	190	0.05	1.8	375	1	0.02	190	0.05	
2020-005040	20,000	190	90	0.05	1.8	190	0.05	1.8	375	0.5	0.01	190	0.05	
2020-005060	20,000	190	90	0.045	1.7	190	0.045	1.7	325	0.5	0.007	190	0.045	
2020-005080	20,000	190	90	0.04	1.5	190	0.04	1.5	325	0.5	0.005	190	0.04	
2020-005100	20,000	190	90	0.028	1.3	190	0.028	1.3	300	0.5	0.005	190	0.028	
2020-010020	20,000	190	125	0.06	1.8	190	0.06	1.8	375	1	0.02	190	0.06	
2020-010040	20,000	190	125	0.06	1.8	190	0.06	1.8	375	0.5	0.01	190	0.06	
2020-010060	20,000	190	125	0.055	1.7	190	0.055	1.7	325	0.5	0.007	190	0.055	
2020-010080	20,000	190	125	0.045	1.5	190	0.045	1.5	325	0.5	0.005	190	0.045	
2020-010100	20,000	190	125	0.033	1.3	190	0.033	1.3	300	0.5	0.005	190	0.033	

These milling parameters are based on VF-20, VM-40, VU-70 (TAS standard) and are for reference only.

Tool life may differ depending on the type of Cemented Carbide / Hard Brittle Materials.

For best result, fine parameter adjustments may be required, depending on the materials of Cemented Carbide / Hard Brittle Materials; milling shape and strategy; machine rigidity and spindle capability.

※Feed Rate 2: Approach feed rate and contact time on the surface.

UDC Series

CBN Series

Square
Long Neck Square

Radius

Radius
Long Neck Radius
Taper Neck Radius

Ball / Long Shark Ball
Long Neck Ball
Taper Neck Ball

Taper

Spiral V Cutter

Drill

EURO Series

Technical Data

Milling Conditions for UDCLRSF

WORK MATERIAL		CEMENTED CARBIDE (<87HRA)											
Model Number	Spindle Speed (min ⁻¹)	Z-Level Milling				Flat Milling			Side Milling			Slotting	
		Feed Rate (mm/min)	※Feed Rate 2 (mm/min)	a_p Axial Depth (mm)	a_e Radial Depth (mm)	Feed Rate (mm/min)	a_p Axial Depth (mm)	a_e Radial Depth (mm)	Feed Rate (mm/min)	a_p Axial Depth (mm)	a_e Radial Depth (mm)	Feed Rate (mm/min)	a_p Axial Depth (mm)
2020-003020	10,000	300	100	0.04	1.8	300	0.04	1.8	1,440	1	0.01	300	0.04
2020-003040	10,000	300	100	0.04	1.8	300	0.04	1.8	1,440	1	0.01	300	0.04
2020-003060	10,000	300	100	0.036	1.6	300	0.036	1.6	1,440	0.5	0.01	300	0.036
2020-003080	10,000	300	100	0.023	1.6	300	0.023	1.6	1,440	0.5	0.009	300	0.023
2020-003100	10,000	300	100	0.018	1.6	300	0.018	1.6	1,440	0.5	0.009	300	0.018
2020-005020	10,000	300	100	0.05	1.8	300	0.05	1.8	1,440	1	0.01	300	0.05
2020-005040	10,000	300	100	0.05	1.8	300	0.05	1.8	1,440	1	0.01	300	0.05
2020-005060	10,000	300	100	0.045	1.6	300	0.045	1.6	1,440	0.5	0.01	300	0.045
2020-005080	10,000	300	100	0.028	1.6	300	0.028	1.6	1,440	0.5	0.009	300	0.028
2020-005100	10,000	300	100	0.02	1.6	300	0.02	1.6	1,440	0.5	0.009	300	0.02
2020-010020	10,000	300	100	0.06	1.8	300	0.06	1.8	1,440	1	0.01	300	0.06
2020-010040	10,000	300	100	0.06	1.8	300	0.06	1.8	1,440	1	0.01	300	0.06
2020-010060	10,000	300	100	0.054	1.6	300	0.054	1.6	1,440	0.5	0.01	300	0.054
2020-010080	10,000	300	100	0.034	1.6	300	0.034	1.6	1,440	0.5	0.009	300	0.034
2020-010100	10,000	300	100	0.023	1.6	300	0.023	1.6	1,440	0.5	0.009	300	0.023

Note:

- This application requires a high cutting force. A machine with poor rigidity and high vibration is not recommended.
- Allow sufficient machine and spindle warm-up time for stability and to remove any expansion of the main spindle before running the program.
- Tool setting length should achieve the least possible overhang.
- Avoid contact with the coated area of the shank. This will prevent tip vibration and tool jamming in the collet / holder.
- Run-out and vibration should be checked dynamically at the tool point while mounted in the machine and both should achieve the lowest level possible.
- Does not require to be slowed down in the approach sequence when slotting and side milling.
- Use an inclined or helical approach when Z-level milling (Recommended inclination angle: <1 degree).
- For flat and side milling, set the axial depth (a_p) and radial depth (a_e) to allow for the uncut material of the corner radius.
- Decrease both spindle speed and feed rate proportionally.
- Air blow is highly recommended for longer tool life. Both oil mist and oil coolant are alternatives.
- Recommend water soluble coolant for Hard Brittle (Non-Metallic) Materials.
- When milling some work pieces, heavier chips may be created. To evacuate these chips it is important to accurately position the coolant nozzle on the milling part.
- Remove chips to prevent heat generation and ignition during milling process.
- Protective gear, such as safety glasses and face guards are required when milling.
- Chips / dust generated while milling can have adverse affects on the machine parts if they are not properly evacuated. Take steps to assure proper evacuation.

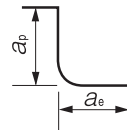

Z-Level / Side / Flat Milling
 a_p : Axial Depth (mm)
 a_e : Radial Depth (mm)

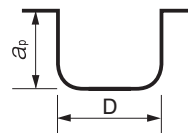

Slotting
 a_p : Axial Depth (mm)
 D : Outside Diameter (mm)

Refer to page 583-587 for features and milling examples of UDC series.

UDC Series
CBN Series
Square
Long Neck Square
Radius
Long Neck Radius
Taper Neck Radius
Ball / Long Shank Ball
Long Neck Ball
Taper Neck Ball
Taper
Spiral V Cutter
Drill
EURO Series
Technical Data



Size R0.1~R3



UDCB



Material Applications (☆ Highly Recommended ◎ Recommended ○ Suggested)

Work Material															
Carbon Steels	Alloy Steels	Prehardened Steels	Hardened Steels			Cast Iron	Aluminum Alloys	Graphite	Copper	Plastics	Glass Filled Plastics	Titanium Alloys	Heat Resistant Alloys	Cemented Carbide	Hard Brittle (Non-Metallic) Materials
S45C S55C	SK / SCM SUS	NAK HPM	~55HRC	~60HRC	~70HRC										
											○ *1			☆	◎ *2

*1 DCB/DCLB series are highly recommended for Glass Filled Plastic milling.

*2 Hard Brittle (Non-Metallic) Materials: Ceramics (Alumina, Zirconia, etc.), Glasses and etc.

Features

Ball type End Mills for milling Cemented Carbide and Hard Brittle (Non-Metallic) Materials.

Developed to give improved hardness and durability, new Diamond coating also has outstanding adhesion to the cutting tool.

By combining the new coating with optimum cutting geometries, the tool “deep cuts” the work piece .

Leaves a burr and pit free surface finish on semi-roughing & finishing process.

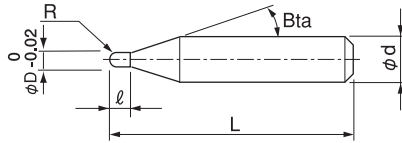

The shank taper angle shown is not an exact value and to avoid contact with the work piece, we recommend the user controls the precise value of this angle. Shank taper angle should not make contact with the work piece.

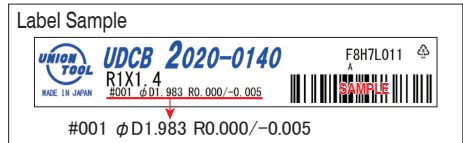

Diameter and Ball R accuracy measurements are printed on the label to support High Precision milling.

Total 14 models

Unit (mm)

Model Number	Radius of Ball Nose R	Length of Cut ℓ	Shank Taper Angle Bta	Overall Length L	Shank Diameter φd	Price ¥
UDCB 2002-0014	R0.1	0.14	16°	50	4	39,160
UDCB 2003-0021	R0.15	0.21	16°	50	4	39,160
UDCB 2004-0028	R0.2	0.28	16°	50	4	35,660
UDCB 2005-0035	R0.25	0.35	16°	50	4	35,660
UDCB 2006-0042	R0.3	0.42	16°	50	4	32,000
UDCB 2007-0049	R0.35	0.49	16°	50	4	32,000
UDCB 2008-0056	R0.4	0.56	16°	50	4	32,000
UDCB 2009-0063	R0.45	0.63	16°	50	4	32,000
UDCB 2010-0070	R0.5	0.7	16°	50	4	32,000
UDCB 2020-0140	R1	1.4	16°	50	4	32,000
UDCB 2030-0210	R1.5	2.1	16°	60	6	35,160
UDCB 2040-0280	R2	2.8	16°	60	6	35,160
UDCB 2050-0350	R2.5	3.5	16°	60	6	35,160
UDCB 2060-0420	R3	4.2	—	60	6	35,160

Milling Conditions for UDCB

WORK MATERIAL			CEMENTED CARBIDE (≥87HRA)					CEMENTED CARBIDE (<87HRA)					HARD BRITTLE MATERIALS				
Model Number	Radius of Ball Nose (mm)	Length of Cut (mm)	Spindle Speed (min ⁻¹)	Feed Rate (mm/min)	※ Feed Rate 2 (mm/min)	a_p Axial Depth (mm)	a_e Radial Depth (mm)	Spindle Speed (min ⁻¹)	Feed Rate (mm/min)	※ Feed Rate 2 (mm/min)	a_p Axial Depth (mm)	a_e Radial Depth (mm)	Spindle Speed (min ⁻¹)	Feed Rate (mm/min)	※ Feed Rate 2 (mm/min)	a_p Axial Depth (mm)	a_e Radial Depth (mm)
2002-0014	R0.1	0.14	30,000	100	10	0.01	0.01	30,000	100	10	0.01	0.01	30,000	100	10	0.01	0.01
2003-0021	R0.15	0.21	30,000	125	13	0.015	0.03	30,000	125	13	0.015	0.03	30,000	125	13	0.015	0.03
2004-0028	R0.2	0.28	30,000	150	15	0.02	0.08	30,000	150	15	0.02	0.08	30,000	150	15	0.02	0.08
2005-0035	R0.25	0.35	30,000	175	18	0.025	0.11	30,000	175	18	0.025	0.11	30,000	175	18	0.025	0.11
2006-0042	R0.3	0.42	30,000	200	20	0.03	0.14	30,000	200	20	0.03	0.14	30,000	200	20	0.03	0.14
2007-0049	R0.35	0.49	30,000	225	23	0.035	0.17	30,000	225	23	0.035	0.17	30,000	225	23	0.035	0.17
2008-0056	R0.4	0.56	30,000	250	25	0.04	0.19	30,000	250	25	0.04	0.19	30,000	250	25	0.04	0.19
2009-0063	R0.45	0.63	30,000	275	28	0.045	0.22	30,000	275	28	0.045	0.22	30,000	275	28	0.045	0.22
2010-0070	R0.5	0.7	30,000	300	30	0.05	0.25	20,000	400	200	0.35	0.075	30,000	300	30	0.05	0.25
2020-0140	R1	1.4	30,000	300	100	0.1	0.3	16,500	420	210	0.25	0.1	24,000	240	100	0.1	0.3
2030-0210	R1.5	2.1	27,500	275	140	0.125	0.33	11,000	280	140	0.38	0.15	24,000	240	120	0.125	0.33
2040-0280	R2	2.8	24,000	240	120	0.15	0.35	8,250	300	150	0.5	0.2	24,000	240	120	0.15	0.35
2050-0350	R2.5	3.5	22,000	220	110	0.175	0.37	6,600	330	160	0.6	0.25	22,000	220	110	0.175	0.37
2060-0420	R3	4.2	20,000	200	100	0.2	0.4	5,500	280	140	0.65	0.28	20,000	200	100	0.2	0.4

These milling parameters are based on VF-20, VM-40, VC-70, VU-70 (TAS standard) for Cemented Carbide, and Alumina for Hard Brittle Materials. These are for reference only.

Tool life may differ depending on the type of Cemented Carbide / Hard Brittle Materials. For best result, fine parameter adjustments may be required, depending on the materials of Cemented Carbide / Hard Brittle Materials; milling shape and strategy; machine rigidity and spindle capability.

※ Feed Rate2: Approach feed rate and contact time on the surface

a_p : Axial Depth (mm)
 a_e : Radial Depth (mm)

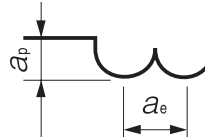

- Note:
- This application requires a high cutting force. A machine with poor rigidity and high vibration is not recommended.
 - Allow sufficient machine and spindle warm-up time for stability and to remove any expansion of the main spindle before running the program.
 - Tool setting length should achieve the least possible overhang.
 - Avoid contact with the coated area of the shank. This will prevent tip vibration and tool jamming in the collet / holder.
 - Run-out and vibration should be checked dynamically at the tool point while mounted in the machine and both should achieve the lowest level possible.
 - Use an inclined or helical approach (Recommended inclination angle: <5 degree).
 - Decrease both spindle speed and feed rate proportionally.
 - Air blow is highly recommended for longer tool life. Both oil mist and oil coolant are alternatives.
 - Recommend water soluble coolant for Hard Brittle (Non-Metallic) Materials.
 - When milling some work pieces, heavier chips may be created. To evacuate these chips it is important to accurately position the coolant nozzle on the milling part.
 - Remove chips to prevent heat generation and ignition during milling process.
 - Protective gear, such as safety glasses and face guards are required when milling.
 - Chips / dust generated while milling can have adverse affects on the machine parts if they are not properly evacuated. Take steps to assure proper evacuation.

Refer to page 583-587 for features and milling examples of UDC series.

UDC Series

CBN Series

Square

Long Neck Square

Radius

Long Neck Radius

Taper Neck Radius

Ball / Long Shank Ball

Long Neck Ball

Taper Neck Ball

Taper

Spiral V Cutter

Drill

EURO Series

Technical Data

Cemented Carbide Hexalobular milled with UDCB R0.5 x Length of Cut 0.7

VF-20 (92.5HRA)

One R0.5 ball end mill removed 91 mm³ of material

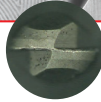
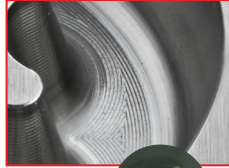

Work size: $\phi 9$ x Depth 2.2 mm

Spindle Speed	30,000 min ⁻¹
Feed Rate	300 mm/min
Axial Depth a_D	0.05 mm
Radial Depth a_e	0.3 mm (Bottom Surface $a_e=0.05$ mm)
Coolant	Oil Mist
Cycle Time	39 min
Material Removal Amount	91.7 mm ³ 2.35 mm ³ /min

Cemented Carbide Pyramid milled with UDCB R0.5 x Length of Cut 0.7

VM-40 (90HRA)

Clean cutter traces ! Equal surface condition !

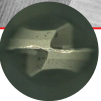
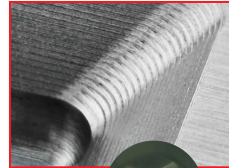

Work size: 6.6 mm x Depth 1.85 mm

Spindle Speed	30,000 min ⁻¹
Feed Rate	300 mm/min
Axial Depth a_D	0.05 mm
Radial Depth a_e	0.25 mm (Bottom Surface $a_e=0.05$ mm)
Coolant	Oil Mist
Cycle Time	24 min
Material Removal Amount	41.3 mm ³ 1.72 mm ³ /min

UDCB Series
VM-40(90HRA)
Pyramid Milling Video



UDCB Series
VF-20(92.5HRA)
Hexalobular Milling Video



Versatile coating !

Alumina / Zirconia Hexalobular milled with UDCB R0.5 x Length of Cut 0.7

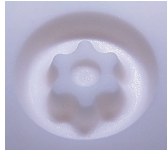
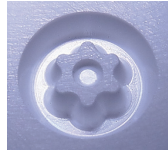
Alumina Al_2O_3 Zirconia ZrO_2 Size : $\phi 9$ mm x Depth 2.2 mm

Tool	UDCB 2010-0070 (R0.5 x 0.7)
Work Material	Alumina Al_2O_3 / Zirconia ZrO_2
Spindle Speed	30,000 min^{-1}
Feed Rate	300 mm/min
Axial Depth a_p	0.05 mm
Radial Depth a_e	0.05 mm
Coolant	Air Blow (Nozzle)
Cycle Time	98 min
Material Removal Amount	88.4 mm^3 0.9 mm^3/min

UDC Series

CBN Series

Square
e Square

Square

Long Neck Square

Radius
Radius

Radius

Long Neck Radius

Taper Neck Radius

Ball / Long Shank Ball

Ball

Long Neck Ball

Taper Neck Ball

Taper

Taper

Spiral V Cutter

Spiral V Cutter

Drill

Drill

EURO Series

EURO Series

Technical Data

Technical Data



Size R0.1~R3



UDCLB



Material Applications (☆ Highly Recommended ◎ Recommended ○ Suggested)

Work Material																	
Carbon Steels	Alloy Steels	Prehardened Steels	Hardened Steels			Cast Iron	Aluminum Alloys	Graphite	Copper	Plastics	Glass Filled Plastics	Titanium Alloys	Heat Resistant Alloys	Cemented Carbide	Hard Brittle (Non-Metallic) Materials		
S45C S55C	SK / SCM SUS	NAK HPM	~55HRC	~60HRC	~70HRC												
															○ *1	☆	◎ *2

*1 DCB/DCLB series are highly recommended for Glass Filled Plastic milling.

*2 Hard Brittle (Non-Metallic) Materials: Ceramics (Alumina, Zirconia, etc.), Glasses and etc.

Total 37 models

Model Number	Radius of Ball Nose R	Effective Length ℓ_1	Length of Cut ℓ	Neck Diameter ϕ_d	Shank Taper Angle Bfa	Overall Length L	Shank Diameter ϕ_d	Price ¥
UDCLB 2002-0030	R0.1	0.3	0.14	0.18	16°	50	4	39,580
UDCLB 2002-0050		0.5				50	4	39,580
UDCLB 2002-0075		0.75				50	4	39,580
UDCLB 2002-0100	R0.2	1	0.28	0.36	16°	50	4	39,580
UDCLB 2004-0050		0.5				50	4	36,080
UDCLB 2004-0100		1				50	4	36,080
UDCLB 2004-0150	R0.3	1.5	0.42	0.56	16°	50	4	36,080
UDCLB 2004-0200		2				50	4	36,080
UDCLB 2006-0100		1				50	4	32,410
UDCLB 2006-0150	R0.4	1.5	0.56	0.76	16°	50	4	32,410
UDCLB 2006-0200		2				50	4	32,410
UDCLB 2006-0300		3				50	4	32,410
UDCLB 2008-0200	R0.5	2	0.7	0.96	16°	50	4	32,410
UDCLB 2008-0300		3				50	4	32,410
UDCLB 2008-0400		4				50	4	32,410
UDCLB 2010-0200	R1	2	1.4	1.9	16°	50	4	32,410
UDCLB 2010-0250		2.5				50	4	32,410
UDCLB 2010-0300		3				50	4	32,410
UDCLB 2010-0400	R1.5	4	2.1	2.9	16°	50	4	32,410
UDCLB 2010-0500		5				50	4	32,410
UDCLB 2020-0300		3				50	4	32,410
UDCLB 2020-0400	R2	4	2.8	3.9	16°	50	4	32,410
UDCLB 2020-0600		6				50	4	32,410
UDCLB 2020-0800		8				50	4	32,410
UDCLB 2020-1000	R2.5	10	3.5	4.8	16°	50	4	32,410
UDCLB 2030-0600		6				60	6	35,580
UDCLB 2030-0800		8				60	6	35,580
UDCLB 2030-1000	R3	10	4.2	5.7	—	60	6	35,580
UDCLB 2030-1200		12				60	6	35,580
UDCLB 2030-1400		14				60	6	35,580
UDCLB 2040-0800	R2	8	2.8	3.9	16°	60	6	35,580
UDCLB 2040-1000		10				60	6	35,580
UDCLB 2040-1500		15				60	6	35,580
UDCLB 2050-1000	R2.5	10	3.5	4.8	16°	60	6	35,580
UDCLB 2050-1500		15				60	6	35,580
UDCLB 2060-1000	R3	10	4.2	5.7	—	60	6	35,580
UDCLB 2060-1500		15				60	6	35,580

Features

Long Neck Ball type End Mills for milling Cemented Carbide and Hard Brittle (Non-Metallic) Materials. Developed to give improved hardness and durability, new Diamond coating also has outstanding adhesion to the cutting tool. By combining the new coating with optimum cutting geometries, the tool "deep cuts" the work piece. Leaves a burr and pit free surface finish on semi-roughing & finishing process.

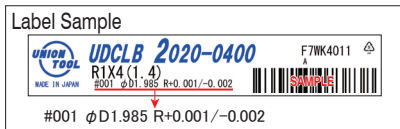
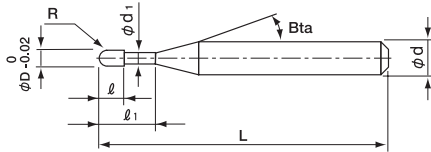

Diameter and Ball R accuracy measurements are printed on the label to support High Precision milling.

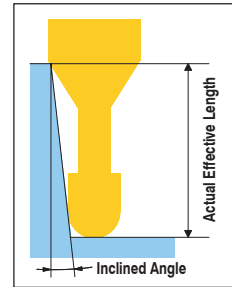

The shank taper angle shown is not an exact value and to avoid contact with the work piece, we recommend the user controls the precise value of this angle. Shank taper angle should not make contact with the work piece.

Unit (mm)

Model Number	Radius of Ball Nose R	Effective Length ℓ_1	Effective Length by Inclined Angles				
			30°	1°	1°30'	2°	3°
UDCLB 2002-0030	RO.1	0.3	0.30	0.31	0.32	0.32	0.34
UDCLB 2002-0050		0.5	0.51	0.52	0.54	0.55	0.59
UDCLB 2002-0075		0.75	0.77	0.79	0.81	0.84	0.89
UDCLB 2002-0100	RO.2	1	1.02	1.05	1.09	1.12	1.20
UDCLB 2004-0050		0.5	0.54	0.55	0.56	0.58	0.61
UDCLB 2004-0100		1	1.06	1.08	1.12	1.15	1.22
UDCLB 2004-0150	RO.3	1.5	1.57	1.62	1.67	1.72	1.83
UDCLB 2004-0200		2	2.09	2.15	2.22	2.29	2.44
UDCLB 2006-0100		1	1.05	1.08	1.11	1.13	1.20
UDCLB 2006-0150	RO.4	1.5	1.57	1.61	1.66	1.70	1.81
UDCLB 2006-0200		2	2.08	2.14	2.21	2.27	2.42
UDCLB 2006-0300		3	3.12	3.21	3.31	3.41	3.65
UDCLB 2008-0200	RO.5	2	2.08	2.14	2.20	2.26	2.40
UDCLB 2008-0300		3	3.11	3.20	3.30	3.40	3.62
UDCLB 2008-0400		4	4.14	4.27	4.40	4.54	4.85
UDCLB 2010-0200	R1	2	2.08	2.13	2.19	2.25	2.38
UDCLB 2010-0250		2.5	2.59	2.66	2.74	2.81	2.99
UDCLB 2010-0300		3	3.11	3.20	3.29	3.38	3.60
UDCLB 2010-0400	R1.5	4	4.14	4.26	4.39	4.52	4.83
UDCLB 2010-0500		5	5.17	5.32	5.49	5.66	6.05
UDCLB 2020-0300		3	3.20	3.27	3.35	3.43	3.62
UDCLB 2020-0400	R2	4	4.23	4.34	4.45	4.57	4.84
UDCLB 2020-0600		6	6.30	6.47	6.65	6.85	7.29
UDCLB 2020-0800		8	8.36	8.60	8.85	9.13	9.74
UDCLB 2020-1000	R2.5	10	10.42	10.73	11.06	11.41	12.19
UDCLB 2030-0600		6	6.28	6.44	6.60	6.78	7.18
UDCLB 2030-0800		8	8.34	8.57	8.80	9.06	9.63
UDCLB 2030-1000	R3	10	10.41	10.70	11.01	11.34	12.08
UDCLB 2030-1200		12	12.47	12.83	13.21	13.61	14.52
UDCLB 2030-1400		14	14.53	14.96	15.41	15.89	16.97
UDCLB 2040-0800	R3	8	8.33	8.53	8.76	8.99	9.52
UDCLB 2040-1000		10	10.39	10.66	10.96	11.27	11.97
UDCLB 2040-1500		15	15.55	15.99	16.46	16.96	18.09
UDCLB 2050-1000	R3	10	10.55	10.82	11.10	11.40	12.07
UDCLB 2050-1500		15	15.71	16.14	16.60	17.09	No Interference
UDCLB 2060-1000	R3	10	No Interference	No Interference	No Interference	No Interference	No Interference
UDCLB 2060-1500		15	No Interference	No Interference	No Interference	No Interference	No Interference

UDC Series

CBN Series

Square

Long Neck Square

Radius

Long Neck Radius

Taper Neck Radius

Ball / Long Shank Ball

Long Neck Ball

Taper Neck Ball

Taper

Spiral V Cutter

Drill

EURO Series

Technical Data

Milling Conditions for UDCLB

WORK MATERIAL			CEMENTED CARBIDE (≥87HRA)					CEMENTED CARBIDE (<87HRA)					HARD BRITTLE MATERIALS				
Model Number	Radius of Ball Nose (mm)	Effective Length (mm)	Spindle Speed (min ⁻¹)	Feed Rate (mm/min)	※Feed Rate 2 (mm/min)	a _p Axial Depth (mm)	a _e Radial Depth (mm)	Spindle Speed (min ⁻¹)	Feed Rate (mm/min)	※Feed Rate 2 (mm/min)	a _p Axial Depth (mm)	a _e Radial Depth (mm)	Spindle Speed (min ⁻¹)	Feed Rate (mm/min)	※Feed Rate 2 (mm/min)	a _p Axial Depth (mm)	a _e Radial Depth (mm)
2002-0030	R0.1	0.3	30,000	100	10	0.01	0.01	30,000	100	10	0.01	0.01	30,000	100	10	0.01	0.01
2002-0050		0.5	30,000	30	10	0.005	0.008	30,000	30	10	0.005	0.008	30,000	30	10	0.005	0.008
2002-0075		0.75	30,000	30	10	0.005	0.006	30,000	30	10	0.005	0.006	30,000	30	10	0.005	0.006
2002-0100		1	30,000	25	10	0.005	0.005	30,000	25	10	0.005	0.005	30,000	25	10	0.005	0.005
2004-0050	R0.2	0.5	30,000	150	15	0.02	0.08	30,000	150	15	0.02	0.08	30,000	150	15	0.02	0.08
2004-0100		1	30,000	100	10	0.015	0.07	30,000	100	10	0.015	0.07	30,000	100	10	0.015	0.07
2004-0150		1.5	30,000	60	10	0.01	0.06	30,000	60	10	0.01	0.06	30,000	60	10	0.01	0.06
2004-0200		2	30,000	30	10	0.008	0.05	30,000	30	10	0.008	0.05	30,000	30	10	0.008	0.05
2006-0100	R0.3	1	30,000	200	20	0.03	0.14	30,000	200	20	0.03	0.14	30,000	200	20	0.03	0.14
2006-0150		1.5	30,000	200	20	0.03	0.14	30,000	200	20	0.03	0.14	30,000	200	20	0.03	0.14
2006-0200		2	30,000	150	15	0.022	0.11	30,000	150	15	0.022	0.11	30,000	150	15	0.022	0.11
2006-0300		3	30,000	75	10	0.01	0.08	30,000	75	10	0.01	0.08	30,000	75	10	0.01	0.08
2008-0200	R0.4	2	30,000	250	25	0.04	0.19	30,000	250	25	0.04	0.19	30,000	250	25	0.04	0.19
2008-0300		3	30,000	230	23	0.037	0.17	30,000	230	23	0.037	0.17	30,000	230	23	0.037	0.17
2008-0400		4	30,000	210	21	0.035	0.16	30,000	210	21	0.035	0.16	30,000	210	21	0.035	0.16
2010-0200		2	30,000	300	30	0.05	0.25	20,000	400	200	0.35	0.075	30,000	300	30	0.05	0.25
2010-0250	R0.5	2.5	30,000	300	30	0.05	0.25	20,000	400	200	0.35	0.075	30,000	300	30	0.05	0.25
2010-0300		3	30,000	300	30	0.05	0.25	20,000	400	200	0.35	0.075	30,000	300	30	0.05	0.25
2010-0400		4	30,000	300	30	0.05	0.25	20,000	400	200	0.3	0.07	30,000	300	30	0.05	0.25
2010-0500		5	30,000	300	30	0.05	0.25	20,000	400	200	0.3	0.07	30,000	300	30	0.05	0.25
2020-0300	R1	3	30,000	300	100	0.1	0.3	16,500	420	210	0.25	0.1	24,000	240	100	0.1	0.3
2020-0400		4	30,000	300	100	0.1	0.3	16,500	420	210	0.25	0.1	24,000	240	100	0.1	0.3
2020-0600		6	30,000	300	100	0.1	0.3	16,500	420	210	0.25	0.1	24,000	240	100	0.1	0.3
2020-0800		8	30,000	300	100	0.1	0.3	16,500	420	210	0.25	0.1	24,000	240	100	0.1	0.3
2020-1000		10	30,000	300	100	0.1	0.3	16,500	420	210	0.25	0.1	24,000	240	100	0.1	0.3
2030-0600		6	27,500	275	140	0.125	0.33	11,000	280	140	0.38	0.15	24,000	240	120	0.125	0.33
2030-0800		8	27,500	275	140	0.125	0.33	11,000	280	140	0.38	0.15	24,000	240	120	0.125	0.33
2030-1000		10	27,500	275	140	0.125	0.33	11,000	280	140	0.3	0.15	24,000	240	120	0.125	0.33
2030-1200	R1.5	12	27,500	220	110	0.125	0.33	11,000	280	140	0.3	0.15	24,000	200	100	0.125	0.33
2030-1400		14	27,500	220	110	0.125	0.33	11,000	280	140	0.3	0.15	24,000	200	100	0.125	0.33
2040-0800		8	24,000	240	120	0.15	0.35	8,250	300	150	0.5	0.2	24,000	240	120	0.15	0.35
2040-1000		10	24,000	240	120	0.15	0.35	8,250	300	150	0.5	0.2	24,000	240	120	0.15	0.35
2040-1500	R2.5	15	24,000	240	120	0.15	0.35	8,250	300	150	0.5	0.2	24,000	240	120	0.15	0.35
2050-1000		10	22,000	220	110	0.175	0.37	6,600	330	160	0.6	0.25	22,000	220	110	0.175	0.37
2050-1500	R3	15	22,000	220	110	0.175	0.37	6,600	330	160	0.6	0.25	22,000	220	110	0.175	0.37
2060-1000		10	20,000	200	100	0.2	0.4	5,500	280	140	0.65	0.28	20,000	200	100	0.2	0.4
2060-1500		15	20,000	200	100	0.2	0.4	5,500	280	140	0.65	0.28	20,000	200	100	0.2	0.4

These milling parameters are based on VF-20, VM-40, VC-70, VU-70 (TAS standard) for Cemented Carbide, and Alumina for Hard Brittle Materials. These are for reference only. Tool life may differ depending on the type of Cemented Carbide / Hard Brittle Materials. For best result, fine parameter adjustments may be required, depending on the materials of Cemented Carbide / Hard Brittle Materials; milling shape and strategy; machine rigidity and spindle capability.

※ Feed Rate 2: Approach feed rate and contact time on the surface.

Note:

- This application requires a high cutting force. A machine with poor rigidity and high vibration is not recommended.
- Allow sufficient machine and spindle warm-up time for stability and to remove any expansion of the main spindle before running the program.
- Tool setting length should achieve the least possible overhang.
- Avoid contact with the coated area of the shank. This will prevent tip vibration and tool jamming in the collet / holder.
- Run-out and vibration should be checked dynamically at the tool point while mounted in the machine and both should achieve the lowest level possible.
- Use an inclined or helical approach (Recommended inclination angle: <5 degree).
- Decrease both spindle speed and feed rate proportionally.
- Air blow is highly recommended for longer tool life. Both oil mist and oil coolant are alternatives.
- Recommend water soluble coolant for Hard Brittle (Non-Metallic) Materials.
- When milling some work pieces, heavier chips may be created. To evacuate these chips it is important to accurately position the coolant nozzle on the milling part.
- Remove chips to prevent heat generation and ignition during milling process.
- Protective gear, such as safety glasses and face guards are required when milling.
- Chips / dust generated while milling can have adverse affects on the machine parts if they are not properly evacuated. Take steps to assure proper evacuation.

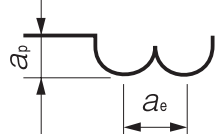

a_p : Axial Depth (mm)
a_e : Radial Depth (mm)

UDC Series

CBN Series

Square

Long Neck Square

Radius

Long Neck Radius

Taper Neck Radius

Ball / Long Shank Ball

Long Neck Ball

Taper Neck Ball

Taper

Spiral V Cutter

Drill

EURO Series

Technical Data

Cemented Carbide Hexalobular milled with UDCLB R0.5 x Effective Length 2 VF-20 (92.5HRA)



Size: $\phi 9$ x Depth 3.5 mm

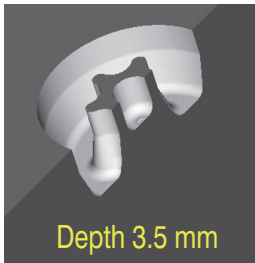

Tool	UDCLB 2010-0200 (R0.5 x 2 mm)
Spindle Speed	$n=30,000 \text{ min}^{-1}$
Feed Rate	$V_f=300 \text{ mm/min}$
Axial Depth a_p	0.05 mm
Radial Depth a_e	0.30 mm (Bottom Surface 0.05 mm)
Coolant	Air Blow
Cycle Time	64.5 min
Material Removal Amount	164.6 mm^3 $2.57 \text{ mm}^3/\text{min}$

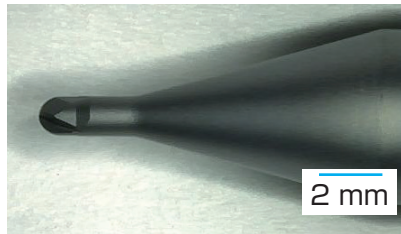

UDCLB
Hexalobular
Milling Video



Cemented Carbide Hexalobular milled with UDCLB R0.5

VF-20 (92.5HRA)



Size:
 $\phi 9$ x Depth 6 mm



Tool	UDCLB 2010-0200 (R0.5 x 2 mm) UDCLB 2010-0500 (R0.5 x 5 mm)
Spindle Speed	$n=30,000 \text{ min}^{-1}$
Feed Rate	$V_f=300 \text{ mm/min}$
Milling Amount	<ol style="list-style-type: none"> R0.5 x 2 Roughing (~Depth 3.5 mm) $a_p=0.05 \text{ mm}$ $a_e=0.3 \text{ mm}$ R0.5 x 5 Roughing (~Depth 6 mm) $a_p=0.05 \text{ mm}$ $a_e=0.25 \text{ mm}$ R0.5 x 5 Finishing $a_p=0.03 \text{ mm}$ $a_e=0.005 \text{ mm}$
Coolant	Air Blow
Cycle Time	156 min
Material Removal Amount	274.4 mm^3

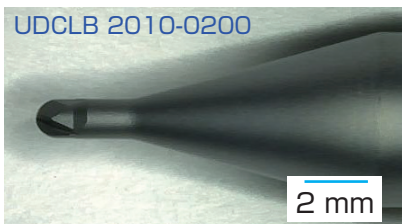

Tool #1 milled depth 3.5 mm.



Tool #2 milled 131.9 mm^3 in 76.5 minutes.

Refer to page 583-587 for features and milling examples of UDC series.

UDC Series

CBN Series

Square

Long Neck Square

Radius

Long Neck Radius

Taper Neck Radius

Ball / Long Shank Ball

Long Neck Ball

Taper Neck Ball

Taper

Spiral V Cutter

Drill

EURO Series

Technical Data



Size $\phi 0.3 \sim \phi 2$



UDCLRS



Material Applications (☆ Highly Recommended ◎ Recommended ○ Suggested)

Work Material															
Carbon Steels S45C S55C	Alloy Steels SK / SCM SUS	Prehardened Steels NAK HPM	Hardened Steels			Cast Iron	Aluminum Alloys	Graphite	Copper	Plastics	Glass Filled Plastics	Titanium Alloys	Heat Resistant Alloys	Cemented Carbide	Hard Brittle (Non-Metallic) Materials
			~55HRC	~60HRC	~70HRC										
														○ *1	◎ *2

*1 UDCLRSF series are highly recommended for Glass Filled Plastic milling.

*2 Hard Brittle (Non-Metallic) Materials: Ceramics (Alumina, Zirconia, etc.), Glasses and etc.

Total 30 models

Unit (mm)

Model Number	Outside Diameter ϕD	Corner Radius CR	Effective Length ℓ_1	Length of Cut ℓ	Neck Diameter ϕd_1	Shank Taper Angle Bta	Overall Length L	Shank Diameter ϕd	Price ¥
UDCLRS 2003-003-006	0.3	RO.03	0.6	0.15	0.28	16°	50	4	45,500
UDCLRS 2003-005-006		RO.05	0.6						
UDCLRS 2005-003-005	0.5	RO.03	0.5	0.25	0.46	16°	50	4	43,300
UDCLRS 2005-003-010			1						
UDCLRS 2005-005-005		RO.05	0.5						
UDCLRS 2005-005-010			1						
UDCLRS 2008-003-008	0.8	RO.03	0.8	0.4	0.76	16°	50	4	38,900
UDCLRS 2008-003-016			1.6						
UDCLRS 2008-005-008		RO.05	0.8						
UDCLRS 2008-005-016			1.6						
UDCLRS 2008-010-008		RO.1	0.8						
UDCLRS 2008-010-016			1.6						
UDCLRS 2010-003-010	1	RO.03	1	0.5	0.96	16°	50	4	38,900
UDCLRS 2010-003-020			2						
UDCLRS 2010-005-010		RO.05	1						
UDCLRS 2010-005-020			2						
UDCLRS 2010-010-010		RO.1	1						
UDCLRS 2010-010-020			2						
UDCLRS 2015-003-015	1.5	RO.03	1.5	0.75	1.44	16°	50	4	38,900
UDCLRS 2015-003-030			3						
UDCLRS 2015-005-015		RO.05	1.5						
UDCLRS 2015-005-030			3						
UDCLRS 2015-010-015		RO.1	1.5						
UDCLRS 2015-010-030			3						
UDCLRS 2020-003-020	2	RO.03	2	1	1.9	16°	50	4	38,900
UDCLRS 2020-003-040			4						
UDCLRS 2020-005-020		RO.05	2						
UDCLRS 2020-005-040			4						
UDCLRS 2020-010-020		RO.1	2						
UDCLRS 2020-010-040			4						

- UDC Series
- CBN Series
- Square
- Long Neck Square
- Radius
- Long Neck Radius
- Taper Neck Radius
- Ball / Long Shank Ball
- Long Neck Ball
- Taper Neck Ball
- Taper
- Spiral V Cutter
- Drill
- EURO Series
- Technical Data

Features

UDC offers excellent drilling performance on Cemented Carbide and Hard Brittle (Non-Metallic) Materials. Developed to give improved hardness and durability, the new Diamond coating also has outstanding adhesion to the cutting tool.

By combining the new coating with optimum cutting geometries, the tool "deep cuts" the work piece. Leaves a burr and pit free surface finish whether roughing, semi-finishing or finishing.

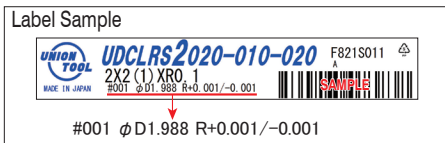
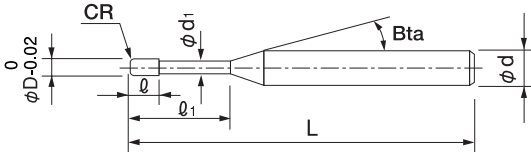
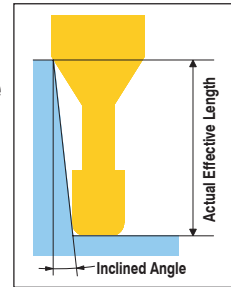

Diameter and Corner R accuracy measurements are printed on the label to support High Precision milling.

The shank taper angle shown is not an exact value and to avoid contact with the work piece, we recommend the user controls the precise value of this angle. Shank taper angle should not make contact with the work piece.

Unit (mm)

Model Number	Outside Diameter φD	Corner Radius CR	Effective Length ℓ ₁	Effective Length by Inclined Angles				
				30'	1°	1° 30'	2°	3°
UDCLRS 2003-003-006	0.3	RO.03	0.6	0.61	0.63	0.65	0.67	0.72
UDCLRS 2003-005-006		RO.05	0.6	0.61	0.63	0.65	0.67	0.72
UDCLRS 2005-003-005	0.5	RO.03	0.5	0.55	0.56	0.58	0.60	0.64
UDCLRS 2005-003-010			1	1.06	1.10	1.13	1.17	1.25
UDCLRS 2005-005-005		RO.05	0.5	0.55	0.56	0.58	0.60	0.64
UDCLRS 2005-005-010			1	1.06	1.09	1.13	1.17	1.25
UDCLRS 2008-003-008	0.8	RO.03	0.8	0.86	0.88	0.91	0.94	1.01
UDCLRS 2008-003-016			1.6	1.68	1.73	1.79	1.85	1.99
UDCLRS 2008-005-008		RO.05	0.8	0.85	0.88	0.91	0.94	1.01
UDCLRS 2008-005-016			1.6	1.68	1.73	1.79	1.85	1.98
UDCLRS 2008-010-008		RO.1	0.8	0.85	0.88	0.90	0.93	0.99
UDCLRS 2008-010-016			1.6	1.68	1.73	1.78	1.84	1.97
UDCLRS 2010-003-010	1	RO.03	1	1.06	1.10	1.13	1.17	1.25
UDCLRS 2010-003-020			2	2.09	2.16	2.23	2.31	2.48
UDCLRS 2010-005-010		RO.05	1	1.06	1.09	1.13	1.17	1.25
UDCLRS 2010-005-020			2	2.09	2.16	2.23	2.31	2.47
UDCLRS 2010-010-010		RO.1	1	1.06	1.09	1.12	1.16	1.24
UDCLRS 2010-010-020			2	2.09	2.16	2.22	2.30	2.46
UDCLRS 2015-003-015	1.5	RO.03	1.5	1.61	1.66	1.72	1.78	1.91
UDCLRS 2015-003-030			3	3.16	3.26	3.37	3.49	3.74
UDCLRS 2015-005-015		RO.05	1.5	1.61	1.66	1.72	1.78	1.90
UDCLRS 2015-005-030			3	3.16	3.26	3.37	3.48	3.74
UDCLRS 2015-010-015		RO.1	1.5	1.61	1.66	1.71	1.77	1.89
UDCLRS 2015-010-030			3	3.16	3.26	3.36	3.48	3.73
UDCLRS 2020-003-020	2	RO.03	2	2.20	2.27	2.35	2.43	2.61
UDCLRS 2020-003-040			4	4.26	4.40	4.55	4.70	5.05
UDCLRS 2020-005-020		RO.05	2	2.20	2.27	2.34	2.42	2.60
UDCLRS 2020-005-040			4	4.26	4.40	4.55	4.70	5.05
UDCLRS 2020-010-020		RO.1	2	2.20	2.27	2.34	2.42	2.59
UDCLRS 2020-010-040			4	4.26	4.40	4.54	4.69	5.04

- UDC Series
- CBN Series
- Square
- Long Neck Square
- Radius
- Long Neck Radius
- Taper Neck Radius
- Ball / Long Shank Ball
- Long Neck Ball
- Taper Neck Ball
- Taper
- Spiral V Cutter
- Drill
- EURO Series
- Technical Data

Milling Conditions for UDCLRS

WORK MATERIAL	Spindle Speed (min ⁻¹)	CEMENTED CARBIDE(≥87HRA) / HARD BRITTLE MATERIALS											
		Z-Level Milling				Flat Milling			Side Milling			Slotting	
Model Number		Feed Rate (mm/min)	※Feed Rate 2 (mm/min)	a _p Axial Depth (mm)	a _e Radial Depth (mm)	Feed Rate (mm/min)	a _p Axial Depth (mm)	a _e Radial Depth (mm)	Feed Rate (mm/min)	a _p Axial Depth (mm)	a _e Radial Depth (mm)	Feed Rate (mm/min)	a _p Axial Depth (mm)
2003-003-006	30,000	220	50	0.01	0.2	220	0.01	0.2	110	0.05	0.001	110	0.01
2003-005-006	30,000	220	50	0.01	0.2	220	0.01	0.2	110	0.05	0.001	110	0.01
2005-003-005	30,000	185	90	0.01	0.4	185	0.01	0.4	375	0.25	0.005	375	0.01
2005-003-010	30,000	185	90	0.01	0.4	185	0.01	0.4	180	0.125	0.005	375	0.01
2005-005-005	30,000	375	125	0.01	0.4	375	0.01	0.4	375	0.25	0.005	375	0.01
2005-005-010	30,000	375	125	0.01	0.4	375	0.01	0.4	180	0.125	0.005	375	0.01
2008-003-008	30,000	185	90	0.01	0.6	185	0.01	0.6	600	0.4	0.008	375	0.01
2008-003-016	30,000	185	90	0.01	0.6	185	0.01	0.6	300	0.2	0.008	375	0.01
2008-005-008	30,000	375	150	0.01	0.6	375	0.01	0.6	600	0.4	0.008	375	0.01
2008-005-016	30,000	375	150	0.01	0.6	375	0.01	0.6	300	0.2	0.008	375	0.01
2008-010-008	30,000	375	150	0.01	0.6	375	0.01	0.6	600	0.4	0.008	375	0.01
2008-010-016	30,000	375	150	0.01	0.6	375	0.01	0.6	300	0.2	0.008	375	0.01
2010-003-010	30,000	185	90	0.01	0.8	185	0.01	0.8	750	0.5	0.01	375	0.01
2010-003-020	30,000	185	90	0.01	0.8	185	0.01	0.8	375	0.25	0.01	375	0.01
2010-005-010	30,000	375	185	0.01	0.8	375	0.01	0.8	750	0.5	0.01	375	0.01
2010-005-020	30,000	375	185	0.01	0.8	375	0.01	0.8	375	0.25	0.01	375	0.01
2010-010-010	30,000	375	185	0.01	0.8	375	0.01	0.8	750	0.5	0.01	375	0.01
2010-010-020	30,000	375	185	0.01	0.8	375	0.01	0.8	375	0.25	0.01	375	0.01
2015-003-015	25,000	185	90	0.01	1.3	185	0.01	1.3	750	0.75	0.01	375	0.015
2015-003-030	25,000	185	90	0.01	1.3	185	0.01	1.3	375	0.375	0.01	375	0.015
2015-005-015	25,000	375	125	0.015	1.3	375	0.015	1.3	750	0.75	0.01	375	0.015
2015-005-030	25,000	375	125	0.015	1.3	375	0.015	1.3	375	0.375	0.01	375	0.015
2015-010-015	25,000	375	150	0.015	1.3	375	0.015	1.3	750	0.75	0.01	375	0.015
2015-010-030	25,000	375	150	0.015	1.3	375	0.015	1.3	375	0.375	0.01	375	0.015
2020-003-020	20,000	185	90	0.01	1.8	185	0.01	1.8	750	1	0.01	375	0.02
2020-003-040	20,000	185	90	0.01	1.8	185	0.01	1.8	375	0.5	0.01	375	0.02
2020-005-020	20,000	375	90	0.02	1.8	375	0.02	1.8	750	1	0.01	375	0.02
2020-005-040	20,000	375	90	0.02	1.8	375	0.02	1.8	375	0.5	0.01	375	0.02
2020-010-020	20,000	375	125	0.02	1.8	375	0.02	1.8	750	1	0.01	375	0.02
2020-010-040	20,000	375	125	0.02	1.8	375	0.02	1.8	375	0.5	0.01	375	0.02

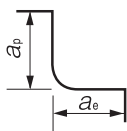

Z-Level / Side / Flat Milling
 a_p : Axial Depth (mm)
 a_e : Radial Depth (mm)

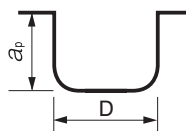

Slotting
 a_p : Axial Depth (mm)
 D : Outside Diameter (mm)

Milling Conditions for UDCLRS

WORK MATERIAL		CEMENTED CARBIDE (<87HRA)											
Model Number	Spindle Speed (min ⁻¹)	Z-Level Milling				Flat Milling			Side Milling			Slotting	
		Feed Rate (mm/min)	※Feed Rate 2 (mm/min)	a _p Axial Depth (mm)	a _e Radial Depth (mm)	Feed Rate (mm/min)	a _p Axial Depth (mm)	a _e Radial Depth (mm)	Feed Rate (mm/min)	a _p Axial Depth (mm)	a _e Radial Depth (mm)	Feed Rate (mm/min)	a _p Axial Depth (mm)
2003-003-006	21,000	220	50	0.01	0.2	220	0.01	0.2	200	0.075	0.003	200	0.01
2003-005-006	21,000	220	50	0.01	0.2	220	0.01	0.2	200	0.075	0.003	200	0.01
2005-003-005	20,000	275	135	0.02	0.4	275	0.02	0.4	800	0.25	0.005	550	0.02
2005-003-010	20,000	275	135	0.02	0.4	275	0.02	0.4	400	0.125	0.005	550	0.02
2005-005-005	20,000	550	180	0.02	0.4	550	0.02	0.4	800	0.25	0.005	550	0.02
2005-005-010	20,000	550	180	0.02	0.4	550	0.02	0.4	400	0.125	0.005	550	0.02
2008-003-008	19,000	290	145	0.02	0.6	290	0.02	0.6	1,200	0.4	0.008	580	0.025
2008-003-016	19,000	290	145	0.02	0.6	290	0.02	0.6	600	0.2	0.008	580	0.025
2008-005-008	19,000	580	190	0.025	0.6	580	0.025	0.6	1,200	0.4	0.008	580	0.025
2008-005-016	19,000	580	190	0.025	0.6	580	0.025	0.6	600	0.2	0.008	580	0.025
2008-010-008	19,000	580	190	0.025	0.6	580	0.025	0.6	1,200	0.4	0.008	580	0.025
2008-010-016	19,000	580	190	0.025	0.6	580	0.025	0.6	600	0.2	0.008	580	0.025
2010-003-010	18,250	300	150	0.02	0.8	300	0.02	0.8	1,440	0.5	0.01	600	0.025
2010-003-020	18,250	300	150	0.02	0.8	300	0.02	0.8	720	0.25	0.01	600	0.025
2010-005-010	18,250	600	200	0.025	0.8	600	0.025	0.8	1,440	0.5	0.01	600	0.025
2010-005-020	18,250	600	200	0.025	0.8	600	0.025	0.8	720	0.25	0.01	600	0.025
2010-010-010	18,250	600	200	0.025	0.8	600	0.025	0.8	1,440	0.5	0.01	600	0.025
2010-010-020	18,250	600	200	0.025	0.8	600	0.025	0.8	720	0.25	0.01	600	0.025
2015-003-015	16,500	325	160	0.02	1.3	325	0.02	1.3	1,440	0.75	0.01	650	0.035
2015-003-030	16,500	325	160	0.02	1.3	325	0.02	1.3	720	0.375	0.01	650	0.035
2015-005-015	16,500	650	210	0.035	1.3	650	0.035	1.3	1,440	0.75	0.01	650	0.035
2015-005-030	16,500	650	210	0.035	1.3	650	0.035	1.3	720	0.375	0.01	650	0.035
2015-010-015	16,500	650	210	0.035	1.3	650	0.035	1.3	1,440	0.75	0.01	650	0.035
2015-010-030	16,500	650	210	0.035	1.3	650	0.035	1.3	720	0.375	0.01	650	0.035
2020-003-020	15,000	360	180	0.02	1.8	360	0.02	1.8	1,440	1	0.01	720	0.05
2020-003-040	15,000	360	180	0.02	1.8	360	0.02	1.8	1,440	1	0.01	720	0.05
2020-005-020	15,000	720	240	0.05	1.8	720	0.05	1.8	1,440	1	0.01	720	0.05
2020-005-040	15,000	720	240	0.05	1.8	720	0.05	1.8	1,440	1	0.01	720	0.05
2020-010-020	15,000	720	240	0.05	1.8	720	0.05	1.8	1,440	1	0.01	720	0.05
2020-010-040	15,000	720	240	0.05	1.8	720	0.05	1.8	1,440	1	0.01	720	0.05

These milling parameters are based on VF-20, VM-40, VU-70 (TAS standard) and are for reference only.

Tool life may differ depending on the type of Cemented Carbide / Hard Brittle Materials.

For best result, fine parameter adjustments may be required, depending on the materials of Cemented Carbide / Hard Brittle Materials; milling shape and strategy; machine rigidity and spindle capability.

※Feed Rate 2: Approach feed rate and contact time on the surface.



Note:

- This application requires a high cutting force. A machine with poor rigidity and high vibration is not recommended.
- Allow sufficient machine and spindle warm-up time for stability and to remove any expansion of the main spindle before running the program.
- Tool setting length should achieve the least possible overhang.
- Avoid contact with the coated area of the shank. This will prevent tip vibration and tool jamming in the collet / holder.
- Run-out and vibration should be checked dynamically at the tool point while mounted in the machine and both should achieve the lowest level possible.
- Does not require to be slowed down in the approach sequence when slotting and side milling.
- Use an inclined or helical approach when Z-level milling (Recommended inclination angle: <1 degree).
- For flat and side milling, set the axial depth (ap) and radial depth (ae) to allow for the uncut material of the corner radius.
- Decrease both spindle speed and feed rate proportionally.
- Air blow is highly recommended for longer tool life. Both oil mist and oil coolant are alternatives.
- Recommend water soluble coolant for Hard Brittle (Non-Metallic) Materials.
- When milling some work pieces, heavier chips may be created. To evacuate these chips it is important to accurately position the coolant nozzle on the milling part.
- Remove chips to prevent heat generation and ignition during milling process.
- Protective gear, such as safety glasses and face guards are required when milling.
- Chips / dust generated while milling can have adverse affects on the machine parts if they are not properly evacuated. Take steps to assure proper evacuation.

Refer to page 583-587 for features and milling examples of UDC series.

UDC Series

CBN Series

Square
Long Neck Square

Radius
Long Neck Radius
Taper Neck Radius

Ball / Long Shank Ball
Long Neck Ball
Taper Neck Ball

Taper

Spiral V Cutter

Drill

EURO Series

Technical Data

Cemented Carbide Milling Example UDCLRS 2020-005-020 ($\phi 2 \times CR0.05 \times 2$) VM-40 (90HRA)

Work sample after finishing

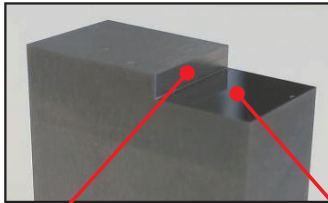

Ra : $0.069 \mu\text{m}$
 Rz : $0.535 \mu\text{m}$
 Cut-off length : 0.25 mm

Ra : $0.010 \mu\text{m}$ (10 nm)
 Rz : $0.078 \mu\text{m}$ (78 nm)
 Cut-off length: 0.08 mm

Bottom Surface Quality



Mirror surface finish
 with zero pits!

After Finishing

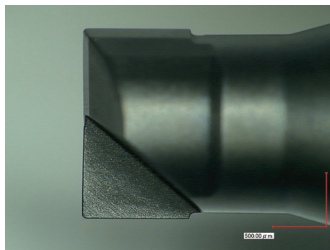
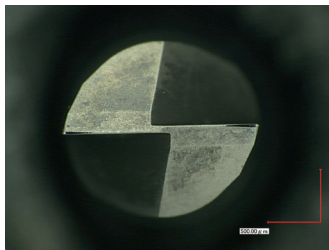
UDCLRS
Side Milling Video

Milling Conditions	Roughing Parameter	Finishing Parameter
Spindle Speed	20,000 min ⁻¹	20,000 min ⁻¹
XY Feed Rate	750 mm/min	100 mm/min
Axial Depth a_p	0.9 mm	0.01 mm Bottom Surface 0.9 mm Side
Radial Depth a_e	0.01 mm	0.01 mm
Coolant	Air Blow	Oil Mist
Milling Size	10 mm \times 8 mm \times 1.8 mm	0.01 mm Bottom Surface 0.05 mm Side (0.01 mm \times 5 Times)
Milling Distance	16 m	—
Material Removal Volume	144 mm ³	—

* One End Mill was used for both the roughing and finishing processes.

Overhang : 15 mm

UDC Series

CBN Series

Square
Long Neck SquareRadius
Long Neck Radius

Taper Neck Radius

Ball / Long Shank Ball

Ball
Long Neck Ball
Taper Neck BallTaper
Taper

Spiral V Cutter

Drill

EURO Series

Technical Data



Size $\phi 0.3 \sim \phi 7$



UDCMX



Material Applications (☆ Highly Recommended ● Recommended ○ Suggested)

Work Material															
Carbon Steels	Alloy Steels	Prehardened Steels	Hardened Steels			Cast Iron	Aluminum Alloys	Graphite	Copper	Plastics	Glass Filled Plastics	Titanium Alloys	Heat Resistant Alloys	Cemented Carbide	Hard Brittle (Non-Metallic) Materials
			~55HRC	~60HRC	~70HRC										
S45C S55C	SK / SCM SUS	NAK HPM												☆	●

* Hard Brittle (Non-Metallic) Materials: Ceramics (Alumina, Zirconia, etc.), Glasses and etc.

Features

UDC offers excellent drilling performance on Cemented Carbide and Hard Brittle (Non-Metallic) Materials. By combining the new coating with optimum tool geometry, the tool improves hole quality and longer tool life. Makes mechanical drilling cost competitive!

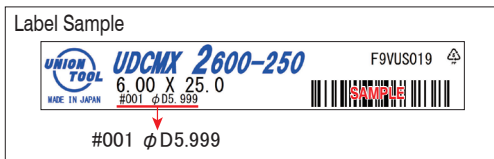

Measured diameter is printed on the label.

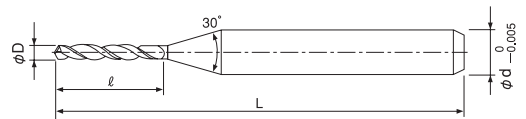

Point Angle : 130°

Diameter Tolerance : 0/-0.02 (D ≤ 3.5)
0/-0.025 (D ≥ 4)

Under-cut type

Enlarged tip drawing



Total 35 models

Unit (mm)

Model Number	Diameter ϕD	Flute Length ℓ	Overall Length L	Shank Diameter ϕd	Price ¥	Cemented Carbide		
						Spindle Speed (min^{-1})	Feed Rate (mm/min)	Peck Amount (mm)
UDCMX 2030-030	0.3	3	38	3	18,000	28,750	5	0.05
UDCMX 2040-040	0.4	4	38	3	18,000	20,000	5	0.05
UDCMX 2050-050	0.5	5	38	3	18,000	15,000	5	0.05
UDCMX 2060-060	0.6	6	38	3	18,000	11,500	5	0.05
UDCMX 2070-070	0.7	7	38	3	18,000	9,000	5	0.05
UDCMX 2080-080	0.8	8	38	3	18,000	7,300	7.5	0.05
UDCMX 2090-090	0.9	9	38	3	18,000	6,000	7.5	0.05
UDCMX 2100-100	1	10	38	3	18,000	5,000	7.5	0.05
UDCMX 2110-100	1.1	10	38	3	18,000	4,500	7.2	0.06
UDCMX 2120-100	1.2	10	38	3	18,000	4,100	6.8	0.07
UDCMX 2130-100	1.3	10	38	3	18,000	3,750	6.5	0.08
UDCMX 2140-100	1.4	10	38	3	18,000	3,450	6.2	0.09

Unit (mm)

Model Number	Diameter ϕD	Flute Length ℓ	Overall Length L	Shank Diameter ϕd	Price ¥	Cemented Carbide		
						Spindle Speed (min ⁻¹)	Feed Rate (mm/min)	Peck Amount (mm)
UDCMX 2150-100	1.5	10	38	3	18,000	3,200	6	0.1
UDCMX 2160-100	1.6	10	38	3	18,000	3,000	6	0.1
UDCMX 2170-100	1.7	10	38	3	18,000	2,850	5.8	0.1
UDCMX 2180-100	1.8	10	38	3	18,000	2,700	5.5	0.1
UDCMX 2190-100	1.9	10	38	3	18,000	2,550	5.3	0.1
UDCMX 2200-100	2	10	38	3	18,000	2,400	5	0.15
UDCMX 2210-100	2.1	10	38	3	18,000	2,300	5	0.15
UDCMX 2220-100	2.2	10	38	3	18,000	2,225	5	0.15
UDCMX 2230-100	2.3	10	38	3	18,000	2,150	5	0.15
UDCMX 2240-100	2.4	10	38	3	18,000	2,075	5	0.15
UDCMX 2250-100	2.5	10	38	3	18,000	2,000	5	0.2
UDCMX 2300-100	3	10	38	3	18,000	1,100	3.7	0.25
UDCMX 2330-120	3.3	12	50	4	20,000	1,000	3.4	0.3
UDCMX 2350-120	3.5	12	50	4	20,000	910	3.3	0.35
UDCMX 2400-160	4	16	60	6	35,500	4,000	6.9	Single-Shot
UDCMX 2420-160	4.2	16	60	6	35,500	4,000	7.3	Single-Shot
UDCMX 2450-200	4.5	20	60	6	35,500	4,000	7.8	Single-Shot
UDCMX 2500-200	5	20	60	6	35,500	4,000	8.7	Single-Shot
UDCMX 2550-250	5.5	25	80	6	38,000	4,000	9.6	Single-Shot
UDCMX 2600-250	6	25	80	6	38,000	4,000	10.5	Single-Shot
UDCMX 2650-250	6.5	25	80	8	48,000	4,000	11.5	Single-Shot
UDCMX 2680-250	6.8	25	80	8	52,000	4,000	12	Single-Shot
UDCMX 2700-250	7	25	80	8	52,000	4,000	12.4	Single-Shot

These milling parameters are based on VM-40 (TAS standard) and are for reference only.

Tool life may differ depending on the type of Cemented Carbide material.

For best results, fine parameter adjustments may be required, depending on the Carbide material; milling shape and strategy; machine rigidity and spindle capability.

Note:

- Allow sufficient machine and spindle warm-up time for stability and to remove any expansion of the main spindle before running the program.
- Tool setting length should achieve the least possible overhang.
- Avoid contact with the coated area of the shank. This will prevent tip vibration and tool jamming in the collet / holder.
- Run-out and vibration should be checked dynamically at the tool point while mounted in the machine and both should achieve the lowest level possible.
- Recommend shallower drilling than flute length to promote good chip evacuation.
- Recommend using peck drilling cycle, but single-shot drilling may extend the tool life in some cases.
- Recommend air blow.
- Recommend water soluble coolant for Hard Brittle (Non-Metallic) Materials.
- Remove chips to prevent heat generation and ignition during milling process.
- Protective gear, such as safety glasses and face guards are required when milling.
- Chips / dust generated while milling can have adverse affects on the machine parts if they are not properly evacuated. Take steps to assure proper evacuation.
- Peck drilling is required depending on the hole quality & hole-edge chipping.
- We recommend to avoid operating the machine unattended when using large size tools with high MRR (Material Removal Rate) per hole. Rapid tool wear, sudden tool damage or breakage might occur depending on the processing environment.
- When milling some work pieces, heavier chips may be created.
To evacuate these chips it is important to accurately position the coolant nozzle on the milling part.

UDC Series

CBN Series

Square

Long Neck Square

Radius

Long Neck Radius

Taper Neck Radius

Ball / Long Shank Ball

Long Neck Ball

Taper Neck Ball

Taper

Spiral V Cutter

Drill

EURO Series

Technical Data

Drilling Cemented Carbide - Stunning!

Cemented Carbide One-shot drilled with UDCMX $\phi 0.4 \times 4$ mm VM-40 (90HRA)

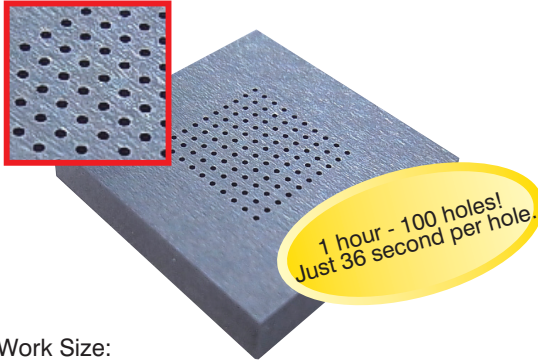

Work Size:
20 mm × 20 mm × 3 mm

Tool	UDCMX 2040-040
Spindle Speed	20,000 min ⁻¹
Feed Rate	5 mm/min
Peck Amount	One-shot
Coolant	Air Blow (Nozzle)
Hole Specification	Blind Hole (Depth 2.8 mm x 100 holes)
Hole Pitch	1 mm
Cycle Time	36 sec per hole

Hole Quality after drilling 100 holes

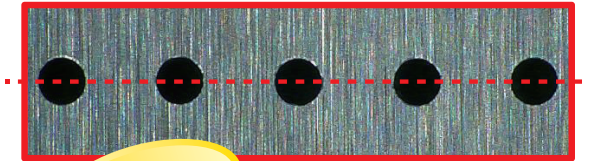

UDCMX
Drilling Video



UDC Series

CBN Series

Square

Long Neck Square

Radius

Long Neck Radius

Taper Neck Radius

Ball / Long Shark Ball

Long Neck Ball

Taper Neck Ball

Taper

Spiral V Cutter

Drill

EURO Series

Technical Data

UDC Series

CBN Series

Square

Square

Long Neck Square

Radius

Radius

Long Neck Radius

Taper Neck Radius

Ball

Ball / Long Shank Ball

Long Neck Ball

Taper Neck Ball

Taper

Taper

Spiral V Cutter

Drill

EURO Series

Technical Data



Size M2~M8



UDCT



Material Applications (☆ Highly Recommended ◎ Recommended ○ Suggested)

Work Material															
Carbon Steels S45C S55C	Alloy Steels SK / SCM SUS	Prehardened Steels NAK HPM	Hardened Steels			Cast Iron	Aluminum Alloys	Graphite	Copper	Plastics	Glass Filled Plastics	Titanium Alloys	Heat Resistant Alloys	Cemented Carbide	Hard Brittle (Non-Metallic) Materials
			~55HRC	~60HRC	~70HRC										
														☆	◎ *

* Hard Brittle (Non-Metallic) Materials: Ceramics (Alumina, Zirconia, etc.), Glasses etc.

Features

Thread Mills for Cemented Carbide and Hard Brittle (Non-Metallic) Materials.
 Direct milling offers higher efficiency and precision comparing to EDM and grinding process.
 Developed to give improved hardness and durability, UDC also has outstanding adhesion to the tool.
 UDC series End Mills and Drills are recommended to drill holes before threading.

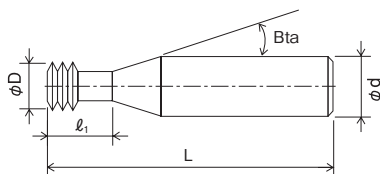

The shank taper angle shown is not an exact value and to avoid contact with the work piece, we recommend the user controls the precise value of this angle. Shank taper angle should not make contact with the work piece.

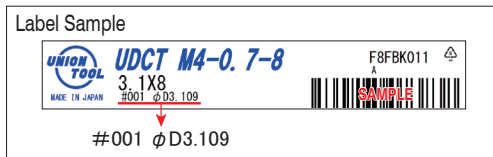

Measured diameter is printed on the label.

Total 10 models

Unit (mm)

Model Number	Thread Diameter M	Pitch P	Tool Diameter φD	Number of Flutes	Effective Length l_1	Shank Taper Angle Bta	Overall Length L	Shank Diameter φd	Price ¥
UDCT M2-0.4-4	M2	0.4	1.5	2	4	16°	50	4	38,900
UDCT M2.5-0.45-5	M2.5	0.45	1.9	2	5	16°	50	4	38,900
UDCT M3-0.5-6	M3	0.5	2.4	2	6	16°	50	4	38,900
UDCT M4-0.7-8	M4	0.7	3.1	2	8	16°	50	4	38,900
UDCT M5-0.8-10	M5	0.8	3.9	2	10	16°	60	6	42,800
UDCT M5-0.8-15					15		60	6	42,800
UDCT M6-1-12	M6	1	4.6	2	12	16°	60	6	42,800
UDCT M6-1-18					18		60	6	42,800
UDCT M8-1.25-16	M8	1.25	5.9	2	16	16°	60	6	42,800
UDCT M8-1.25-24					24		60	6	42,800

Milling Conditions for UDCT

Model Number	WORK MATERIAL			CEMENTED CARBIDE			
	Thread Diameter M	Pitch P	Tool Diameter ϕD	Effective Length l_1	Recommended Pilot Hole Diameter (mm)	Spindle Speed (mm ⁻¹)	Feed Rate (mm/min)
M2-0.4-4	M2	0.4	1.5	4	$\phi 1.6$	20,000	3
M2.5-0.45-5	M2.5	0.45	1.9	5	$\phi 2.1$	20,000	3
M3-0.5-6	M3	0.5	2.4	6	$\phi 2.5$	20,000	3
M4-0.7-8	M4	0.7	3.1	8	$\phi 3.3$	10,050	30
M5-0.8-10	M5	0.8	3.9	10	$\phi 4.2$	8,000	30
M5-0.8-15				15			
M6-1-12	M6	1	4.6	12	$\phi 5$	6,800	30
M6-1-18				18			
M8-1.25-16	M8	1.25	5.9	16	$\phi 6.8$	3,500	20
M8-1.25-24				24			

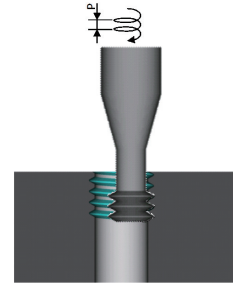

* Revised and reduced the spindle speed and feed rate for better tool life.

* These milling parameters are based on VM-40 (TAS standard) and are for reference only.

Tool life may differ depending on the type of Cemented Carbide material.

For best results, fine parameter adjustments may be required, depending on the Carbide material; milling shape and strategy; machine rigidity and spindle capability.

Note:

- This application requires a high cutting force. A machine with poor rigidity and high vibration is not recommended.
- Use a machine equipped with helical interpolating functions.
- Allow sufficient machine and spindle warm-up time for stability and to remove any expansion of the main spindle before running the program.
- Tool setting length should achieve the least possible overhang.
- Avoid contact with the coated area of the shank. This will prevent tip vibration and tool jamming in the collet / holder.
- Run-out and vibration should be checked dynamically at the tool point while mounted in the machine and both should achieve the lowest level possible.
- Decrease both spindle speed and feed rate proportionally.
- The feed rate is measured at the center of the tool.
- The radial cutting depth is recommended to cut all at once. Do not cut several times.
- Adjust turning radius amount to meet required internal thread precision.
- Air blow is highly recommended for longer tool life. Both oil mist and oil coolant are alternatives.
- Recommend water soluble coolant for Hard Brittle (Non-Metallic) Materials.
- When milling some work pieces, heavier chips may be created. To evacuate these chips it is important to accurately position the coolant nozzle on the milling part.
- Remove chips to prevent heat generation and ignition during milling process.
- Protective gear, such as safety glasses and face guards are required when milling.
- Chips / dust generated while milling can have adverse affects on the machine parts if they are not properly evacuated. Take steps to assure proper evacuation.

"Direct Drilling & Thread Milling" on Cemented Carbide!!

Cemented Carbide UDCTX $\phi 2.5$ (Hole Before Threading) + UDCT M3 (Thread Milling) VM-40 (90HRA)

After drilling Holes
before threading

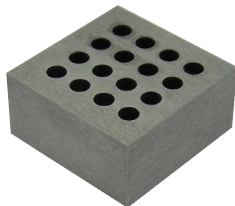

After thread milling



Work Size:
20 mm x 20 mm x 10 mm

	Hole Before Threading	Thread Milling
Tool	UDCTX 2250-100	UDCT M3-0.5-6
Spindle Speed	2,000 min ⁻¹	20,000 min ⁻¹
Feed Rate	5 mm/min	3 mm/min
Peck Amount	0.5 mm	—
Coolant	Air Blow (Nozzle)	
Hole Specification	Blind Hole Depth 8 mm x 16 holes	Depth 6 mm x 16 holes
Cycle Time	2 min 2 sec per hole	9 min 15 sec per hole

New standard for Cemented Carbide Processing

- Cracks are minimized.
- Time and cost savings comparing to EDM process.
- Highly precise thread geometry generated by single path threading.

UDC Series

CBN Series

Square

Long Neck Square

Radius

Long Neck Radius

Taper Neck Radius

Ball / Long Shank Ball

Long Neck Ball

Taper Neck Ball

Taper

Spiral V Cutter

Drill

EURO Series

Technical Data



Size R0.05~R1

CBN-LBSF



Patent pending

Material Applications (☆ Highly Recommended ○ Recommended ○ Suggested)

Work Material															
Carbon Steels	Alloy Steels	Prehardened Steels	Hardened Steels			Cast Iron	Aluminum Alloys	Graphite	Copper	Plastics	Glass Filled Plastics	Titanium Alloys	Heat Resistant Alloys	Cemented Carbide	Hard Brittle (Non-Metallic) Materials
S45C S55C	SK / SCM SUS	NAK HPM	~55HRC	~60HRC	~70HRC										
		○	○	○	○ ~68HRC										

Features

Optimized CBN material for milling the ultra-hard materials, with excellent wear resistance and chipping resistance offers long tool life.

Improved milling surface by the original flute design.

For higher precision surface and better surface finish.

Highly precision shank diameter tolerance, 0/-0.004 mm.

Ball radius accuracy ± 0.002 mm based on Nominal Radius.

※ Based on Nominal Radius : Directly input the catalogue ball radius rate into the CAM for higher precision milling.

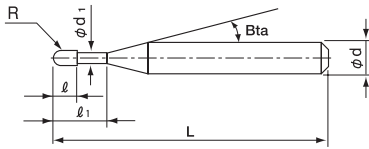

The shank taper angle shown is not an exact value and to avoid contact with the work piece, we recommend the user controls the precise value of this angle. Shank taper angle should not make contact with the work piece.



Ball R accuracy measurements are printed on the label to support High Precision milling.

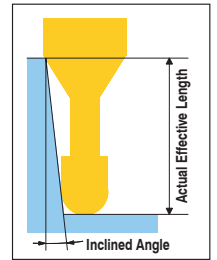

Total 36 models

*Shank taper angle Bta is only for reference.

Unit (mm)

Model Number	Radius of Ball Nose R	Effective Length l_1	Length of Cut l	Neck Diameter ϕd_1	Shank Taper Angle Bta	Overall Length L	Shank Diameter ϕd	Price ¥	Effective Length by Inclined Angles				
									30°	1°	1°30'	2°	3°
CBN-LBSF 2001-003	R0.05	0.3	0.07	0.09	15°	50	4	46,700	0.30	0.30	0.30	0.30	0.33
CBN-LBSF 2001-005		0.5							0.50	0.50	0.51	0.53	0.57
CBN-LBSF 20015-0045	R0.075	0.45	0.1	0.14	15°	50	4	46,700	0.45	0.45	0.46	0.48	0.51
CBN-LBSF 20015-0075		0.75							0.75	0.76	0.78	0.81	0.88
CBN-LBSF 2002-003	R0.1	0.3	0.13	0.19	15°	50	4	35,000	0.30	0.30	0.30	0.30	0.32
CBN-LBSF 2002-006		0.6							0.60	0.60	0.62	0.64	0.69

Model Number	Radius of Ball Nose R	Effective Length ℓ_1	Length of Cut ℓ	Neck Diameter ϕd_1	Shank Taper Angle β	Overall Length L	Shank Diameter ϕd	Price ¥	Effective Length by Inclined Angles				
									30°	1°	1°30'	2°	3°
CBN-LBSF 2003-005	RO.15	0.5	0.22	0.28	15°	50	4	33,900	0.51	0.53	0.54	0.56	0.60
CBN-LBSF 2003-0075		0.75							0.77	0.79	0.82	0.85	0.91
CBN-LBSF 2003-009		0.9							0.91	0.94	0.97	1.01	1.08
CBN-LBSF 2004-0075	RO.2	0.75	0.32	0.38	15°	50	4	30,600	0.77	0.79	0.81	0.84	0.90
CBN-LBSF 2004-010		1							1.03	1.06	1.09	1.13	1.21
CBN-LBSF 2004-012		1.2							1.22	1.26	1.30	1.35	1.44
CBN-LBSF 2005-010	RO.25	1	0.4	0.48	15°	50	4	31,200	1.01	1.04	1.07	1.11	1.18
CBN-LBSF 2005-015		1.5							1.53	1.58	1.63	1.68	1.80
CBN-LBSF 2006-010	RO.3	1	0.48	0.58	15°	50	4	28,700	1.01	1.04	1.07	1.10	1.17
CBN-LBSF 2006-015		1.5							1.53	1.57	1.62	1.68	1.79
CBN-LBSF 2006-020		2							2.05	2.11	2.18	2.25	2.41
CBN-LBSF 2008-020	RO.4	2	0.6	0.78	15°	50	4	29,300	2.04	2.10	2.17	2.24	2.39
CBN-LBSF 2008-040		4							4.11	4.24	4.38	4.54	4.88
CBN-LBSF 2010-015	RO.5	1.5	0.7	0.98	15°	50	4	28,700	1.53	1.57	1.61	1.66	1.76
CBN-LBSF 2010-020		2							2.05	2.11	2.17	2.23	2.38
CBN-LBSF 2010-025		2.5							2.57	2.64	2.72	2.81	3.00
CBN-LBSF 2010-030		3							3.09	3.18	3.28	3.38	3.62
CBN-LBSF 2010-040		4							4.12	4.25	4.38	4.53	4.87
CBN-LBSF 2010-060		6							6.19	6.39	6.60	6.83	7.35
CBN-LBSF 2015-025	RO.75	2.5	0.9	1.46	15°	50	4	30,000	2.60	2.67	2.74	2.81	2.99
CBN-LBSF 2015-030		3							3.12	3.20	3.29	3.39	3.61
CBN-LBSF 2015-038		3.8							3.94	4.06	4.18	4.31	4.61
CBN-LBSF 2015-060		6							6.22	6.41	6.62	6.84	7.34
CBN-LBSF 2015-080		8							8.28	8.55	8.83	9.14	9.83
CBN-LBSF 2020-030	R1	3	1.2	1.97	15°	50	4	30,500	3.09	3.16	3.24	3.33	3.53
CBN-LBSF 2020-040		4							4.12	4.23	4.35	4.48	4.77
CBN-LBSF 2020-050		5							5.16	5.30	5.46	5.63	6.01
CBN-LBSF 2020-060		6							6.19	6.37	6.57	6.78	7.26
CBN-LBSF 2020-080		8							8.26	8.51	8.79	9.08	9.74
CBN-LBSF 2020-100		10							10.32	10.65	11.00	11.38	12.23

UDC Series

CBN Series

Square

Long Neck Square

Radius

Long Neck Radius

Taper Neck Radius

Ball / Long Shank Ball

Long Neck Ball

Taper Neck Ball

Taper

Spiral V Cutter

Drill

EURO Series

Technical Data

Milling Conditions for CBN-LBSF

WORK MATERIAL			HEAT-TREATED STEELS / HARDENED STEELS STAVAX / ELMAX / HAP10 / HAP72 (~68HRC)			
Model Number	Radius of Ball Nose (mm)	Effective Length (mm)	Spindle Speed (min ⁻¹)	Feed Rate (mm/min)	a _p Axial Depth (mm)	a _e Radial Depth (mm)
2001-003	R0.05	0.3	30,000	70	0.003MAX	0.006MAX
2001-005		0.5	30,000	70	0.002MAX	0.006MAX
20015-0045	R0.075	0.45	30,000	150	0.004MAX	0.008MAX
20015-0075		0.75	30,000	125	0.004MAX	0.008MAX
2002-003	R0.1	0.3	30,000	240	0.005MAX	0.01 MAX
2002-006		0.6	30,000	200	0.005MAX	0.01 MAX
2003-005	R0.15	0.5	30,000	300	0.005MAX	0.01 MAX
2003-0075		0.75	30,000	250	0.005MAX	0.01 MAX
2003-009		0.9	30,000	250	0.005MAX	0.01 MAX
2004-0075	R0.2	0.75	30,000	360	0.005MAX	0.01 MAX
2004-010		1	30,000	300	0.005MAX	0.01 MAX
2004-012		1.2	30,000	300	0.005MAX	0.01 MAX
2005-010	R0.25	1	30,000	420	0.005MAX	0.01 MAX
2005-015		1.5	30,000	350	0.005MAX	0.01 MAX
2006-010	R0.3	1	30,000	500	0.01 MAX	0.015MAX
2006-015		1.5	30,000	500	0.01 MAX	0.015MAX
2006-020	R0.4	2	30,000	350	0.01 MAX	0.015MAX
2008-020		2	30,000	620	0.01 MAX	0.015MAX
2008-040	R0.5	4	30,000	420	0.01 MAX	0.015MAX
2010-015		1.5	30,000	750	0.01 MAX	0.02 MAX
2010-020	R0.5	2	30,000	750	0.01 MAX	0.02 MAX
2010-025		2.5	30,000	750	0.01 MAX	0.02 MAX
2010-030		3	30,000	500	0.01 MAX	0.02 MAX
2010-040		4	30,000	500	0.01 MAX	0.02 MAX
2010-060	R0.75	6	30,000	330	0.01 MAX	0.02 MAX
2015-025		2.5	20,000	750	0.01 MAX	0.02 MAX
2015-030		3	20,000	750	0.01 MAX	0.02 MAX
2015-038		3.8	20,000	750	0.01 MAX	0.02 MAX
2015-060		6	20,000	500	0.01 MAX	0.02 MAX
2015-080	R1	8	20,000	500	0.01 MAX	0.02 MAX
2020-030		3	15,000	750	0.01 MAX	0.025MAX
2020-040		4	15,000	750	0.01 MAX	0.025MAX
2020-050		5	15,000	750	0.01 MAX	0.025MAX
2020-060		6	15,000	500	0.01 MAX	0.025MAX
2020-080		8	15,000	500	0.01 MAX	0.025MAX
2020-100	10	15,000	500	0.01 MAX	0.025MAX	

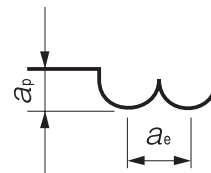

a_p : Axial Depth (mm)
a_e : Radial Depth (mm)

Note:

- Decrease both spindle speed and feed rate proportionally when the milling parameters exceed the machine's maximum spindle speed.
- Recommend oil mist to avoid tool damage.

Milling Example of Inclined Surface CBN-LBSF R0.3 × Effective Length 1.5

ELMAX (60.5HRC)

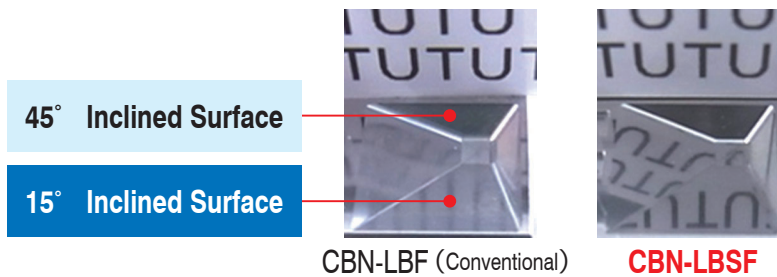

CBN-LBF (Conventional)

CBN-LBSF

Work Size : 9 × 9 × Depth 1.5 mm

Coolant : Oil Mist

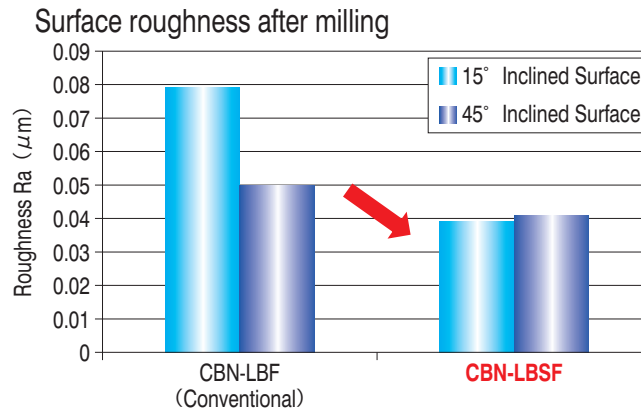

Tool	CBN-LBSF 2006-015
Milling Process	Finishing
Milling Method	Contour spiral milling
Spindle Speed	30,000 min ⁻¹
Feed Rate	550 mm/min
Allowance	0.005 mm
Cusp Height	0.0001 mm
Cycle Time	21.5 min

**Greatly improved surface finish compared with
the conventional CBN-LBF series.**

UDC
SeriesCBN
SeriesSquare
Long Neck
SquareRadius
Long Neck
RadiusTaper Neck
RadiusBall / Long
Shank Ball
Long Neck
Ball
Taper Neck
Ball

Taper

Spiral
V Cutter

Drill

EURO Series

Technical Data

Milling example of lens application

CBN-LBSF R0.3 · R1

HAP10 (64HRC)

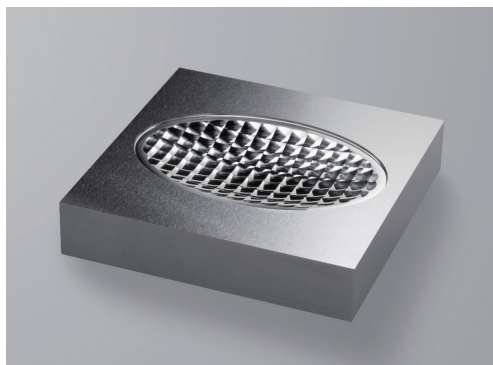

Work Size : 100 × 100 × 20 mm
Coolant : Oil Mist
Oil Coolant

No.	Process	Tool	Spindle Speed (min ⁻¹)	Feed Rate (mm/min)	a_p Axial Depth (mm)	a_e Radial Depth (mm)	Allowance (mm)	Cycle Time (h:m)
1	Roughing	HGB 2040-0600 (R2 x Length of Cut 6)	9,480	2,400	0.18	0.75	0.08	1:01
2	Lens part / Semi-roughing		9,480	2,400	0.18	0.375	0.05	0:06
3	Periphery / Semi-roughing	HGB 2020-0300 (R1 x Length of Cut 3)	14,700	2,160	0.1	0.35	0.05	0:07
4	Periphery / Semi-finishing 1		14,700	2,160	0.1	0.1	0.02	0:03
5	Lens part / Semi-finishing 1		14,700	2,160	0.03	0.1	0.02	0:36
6	Periphery / Semi-finishing 2	HGB 2010-0150 (R0.5 x Length of Cut 1.5)	21,000	1,750	0.04	0.04	0.005	0:15
7	Lens part / Semi-finishing 2	HGB 2020-0300 (R1 x Length of Cut 3)	14,700	2,160	0.015	0.05	0.005	1:13
8	Periphery / Finishing	CBN-LBSF 2006-010 (R0.3 x Effective Length 1)	30,000	600	0.01	0.01	0	2:56
9	Lens part / Finishing	CBN-LBSF 2020-030 (R1 x Effective Length 3)	24,000	750	0.005	0.018	0	4:52

Total 11:09

UDC Series

CBN Series

Square

Long Neck Square

Radius

Long Neck Radius

Taper Neck Radius

Ball / Long Shark Ball

Long Neck Ball

Taper Neck Ball

Taper

Spiral V Cutter

Drill

EURO Series

Technical Data

UDC Series

CBN Series

Square

Square

Long Neck Square

Radius

Radius

Long Neck Radius

Taper Neck Radius

Ball

Ball / Long Shank Ball

Long Neck Ball

Taper Neck Ball

Taper

Taper

Spiral V Cutter

Spiral V Cutter

Drill

EURO Series

Technical Data



Size R0.05~R1

CBN-LBF



Material Applications (☆ Highly Recommended ○ Recommended ○ Suggested)

Work Material															
Carbon Steels	Alloy Steels	Prehardened Steels	Hardened Steels			Cast Iron	Aluminum Alloys	Graphite	Copper	Plastics	Glass Filled Plastics	Titanium Alloys	Heat Resistant Alloys	Cemented Carbide	Hard Brittle (Non-Metallic) Materials
S45C S55C	SK / SCM SUS	NAK HPM	~55HRC	~60HRC	~70HRC										
		○	○	○	○										

Features

Optimized CBN material for milling ultra-hard materials and cutting edge geometry offer highly precision milling and long tool life. Excellent wear resistance and chipping resistance maintain outstanding surface roughness and precision throughout the long cycle time. High precision shank diameter tolerance, 0/-0.004 mm.

CBN-LBF : Ball radius accuracy ± 0.003 mm based on Nominal Radius.

※ Based on Nominal Radius : Directly input the catalogue ball radius rate into the CAM for higher precision milling.

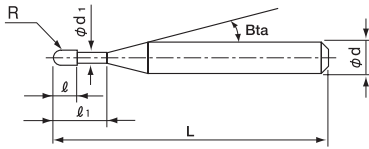

The shank taper angle shown is not an exact value and to avoid contact with the work piece, we recommend the user controls the precise value of this angle. Shank taper angle should not make contact with the work piece.

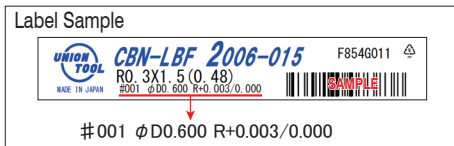

Diameter and Ball R accuracy measurements are printed on the label to support High Precision milling.

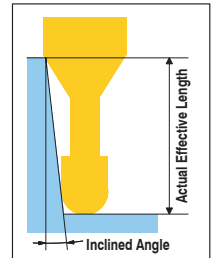

Total 58 models

*Shank taper angle Bta is only for reference.

Unit (mm)

Model Number	Radius of Ball Nose R	Effective Length l_1	Length of Cut l	Neck Diameter ϕd_1	Shank Taper Angle Bta	Overall Length L	Shank Diameter ϕd	Price ¥	Effective Length by Inclined Angles				
									30°	1°	1°30'	2°	3°
CBN-LBF 2001-003	R0.05	0.3	0.08	0.09	15°	50	4	42,400	0.30	0.30	0.30	0.30	0.33
CBN-LBF 2001-005		0.5							0.50	0.50	0.51	0.53	0.57
CBN-LBF 20015-0045	R0.075	0.45	0.15	0.14	15°	50	4	42,400	0.45	0.45	0.46	0.48	0.51
CBN-LBF 20015-0075		0.75							0.75	0.76	0.78	0.81	0.88
CBN-LBF 2002-003	R0.1	0.3	0.16	0.19	15°	50	4	28,800	0.30	0.30	0.30	0.30	0.32
CBN-LBF 2002-006		0.6							0.60	0.60	0.62	0.64	0.69
CBN-LBF 2002-010		1							1.00	1.03	1.06	1.10	1.19
CBN-LBF 2003-005	R0.15	0.5	0.24	0.28	15°	50	4	28,800	0.51	0.53	0.54	0.56	0.60
CBN-LBF 2003-0075		0.75							0.77	0.79	0.82	0.85	0.91
CBN-LBF 2003-009		0.9							0.91	0.94	0.96	1.00	1.06
CBN-LBF 2003-015		1.5							1.53	1.58	1.63	1.68	1.80

Model Number	Radius of Ball Nose R	Effective Length l_1	Length of Cut l	Neck Diameter ϕd_1	Shank Taper Angle Bta	Overall Length L	Shank Diameter ϕd	Price ¥	Effective Length by Inclined Angles				
									30°	1°	1°30'	2°	3°
CBN-LBF 2004-005	R0.2	0.5	0.32	0.38	15°	50	4	27,700	0.51	0.52	0.54	0.55	0.58
CBN-LBF 2004-0075		0.75				50	4	27,700	0.77	0.79	0.81	0.84	0.90
CBN-LBF 2004-010		1				50	4	27,700	1.03	1.06	1.09	1.13	1.21
CBN-LBF 2004-012		1.2				50	4	28,800	1.22	1.25	1.29	1.33	1.42
CBN-LBF 2004-020		2				50	4	30,600	2.04	2.10	2.17	2.24	2.40
CBN-LBF 2004-030		3				50	4	33,300	3.07	3.17	3.27	3.38	3.62
CBN-LBF 2005-010	R0.25	1	0.4	0.48	15°	50	4	27,700	1.02	1.05	1.08	1.12	1.19
CBN-LBF 2005-015		1.5				50	4	28,800	1.53	1.57	1.62	1.66	1.78
CBN-LBF 2005-025		2.5				50	4	30,600	2.56	2.63	2.72	2.80	3.00
CBN-LBF 2005-035		3.5				50	4	32,200	3.59	3.70	3.82	3.94	4.22
CBN-LBF 2006-010	R0.3	1	0.48	0.58	15°	50	4	26,600	1.02	1.05	1.08	1.11	1.18
CBN-LBF 2006-015		1.5				50	4	26,600	1.52	1.57	1.61	1.66	1.76
CBN-LBF 2006-030		3				50	4	28,400	3.07	3.16	3.26	3.37	3.60
CBN-LBF 2006-040		4				50	4	28,400	4.10	4.23	4.36	4.50	4.82
CBN-LBF 2006-050		5				50	4	28,800	5.13	5.29	5.46	5.64	6.05
CBN-LBF 2006-060		6				50	4	31,600	6.17	6.36	6.56	6.78	7.27
CBN-LBF 2008-020	R0.4	2	0.6	0.78	15°	50	4	26,600	2.04	2.09	2.15	2.21	2.35
CBN-LBF 2008-040		4				50	4	28,400	4.10	4.22	4.35	4.49	4.80
CBN-LBF 2008-060		6				50	4	31,100	6.16	6.35	6.55	6.77	7.25
CBN-LBF 2010-015	R0.5	1.5	0.7	0.98	15°	50	4	26,600	1.53	1.57	1.61	1.66	1.76
CBN-LBF 2010-020		2				50	4	26,600	2.05	2.11	2.17	2.23	2.38
CBN-LBF 2010-025		2.5				50	4	26,600	2.56	2.63	2.70	2.78	2.96
CBN-LBF 2010-040		4				50	4	28,400	4.11	4.23	4.35	4.49	4.79
CBN-LBF 2010-050		5				50	4	28,400	5.14	5.29	5.45	5.63	6.02
CBN-LBF 2010-060		6				50	4	28,400	6.17	6.36	6.55	6.77	7.24
CBN-LBF 2010-080		8				50	4	28,800	8.23	8.49	8.76	9.04	9.69
CBN-LBF 2010-100		10				50	4	29,500	10.30	10.62	10.96	11.32	12.13
CBN-LBF 2012-024	R0.6	2.4	0.8	1.18	15°	50	4	27,700	2.46	2.53	2.60	2.68	2.85
CBN-LBF 2012-030		3				50	4	27,700	3.08	3.17	3.27	3.37	3.60
CBN-LBF 2012-060		6				50	4	32,200	6.18	6.38	6.59	6.82	7.33
CBN-LBF 2015-030	R0.75	3	0.9	1.46	15°	50	4	27,700	3.12	3.20	3.29	3.39	3.61
CBN-LBF 2015-040		4				50	4	27,700	4.15	4.27	4.40	4.54	4.85
CBN-LBF 2015-060		6				50	4	27,700	6.22	6.41	6.62	6.84	7.34
CBN-LBF 2015-080		8				50	4	30,600	8.28	8.55	8.83	9.14	9.83
CBN-LBF 2015-100		10				50	4	32,200	10.35	10.69	11.05	11.44	12.31
CBN-LBF 2015-120		12				50	4	32,200	12.42	12.83	13.27	13.74	14.80
CBN-LBF 2015-150	15	50	4	32,200	15.52	16.04	16.59	17.19	18.53				
CBN-LBF 2020-040	R1	4	1.2	1.97	15°	50	4	27,700	4.12	4.23	4.35	4.48	4.77
CBN-LBF 2020-050		5				50	4	27,700	5.16	5.30	5.46	5.63	6.01
CBN-LBF 2020-060		6				50	4	27,700	6.19	6.37	6.57	6.78	7.26
CBN-LBF 2020-080		8				50	4	30,600	8.26	8.51	8.79	9.08	9.74
CBN-LBF 2020-100		10				50	4	30,600	10.32	10.65	11.00	11.38	12.23
CBN-LBF 2020-120		12				50	4	32,200	12.39	12.79	13.22	13.68	14.72
CBN-LBF 2020-140		14				50	4	32,700	14.46	14.93	15.44	15.98	17.20
CBN-LBF 2020-160		16				50	4	32,700	16.53	17.07	17.65	18.28	19.69
CBN-LBF 2020-180		18				50	4	32,700	18.59	19.21	19.87	20.58	No Interference
CBN-LBF 2020-200		20				50	4	32,700	20.66	21.35	22.09	22.88	No Interference

UDC Series

CBN Series

Square

Long Neck Square

Radius

Long Neck Radius

Taper Neck Radius

Ball / Long Shank Ball

Long Neck Ball

Taper Neck Ball

Taper

Spiral V Cutter

Drill

EURO Series

Technical Data

Milling Conditions for CBN-LBF

WORK MATERIAL			HEAT-TREATED STEELS / HARDENED STEELS STAVAX (~52HRC)				HARDENED STEELS SKD11 (~62HRC)				HARDENED STEELS HAP10 / HAP72 (~68HRC)			
Model Number	Radius of Ball Nose (mm)	Effective Length (mm)	Spindle Speed (min ⁻¹)	Feed Rate (mm/min)	a _p Axial Depth (mm)	a _e Radial Depth (mm)	Spindle Speed (min ⁻¹)	Feed Rate (mm/min)	a _p Axial Depth (mm)	a _e Radial Depth (mm)	Spindle Speed (min ⁻¹)	Feed Rate (mm/min)	a _p Axial Depth (mm)	a _e Radial Depth (mm)
2001-003	R0.05	0.3	30,000	200	0.005	0.005	30,000	150	0.003	0.005	30,000	100	0.002	0.005
2001-005		0.5	30,000	150	0.003	0.005	30,000	120	0.003	0.005	30,000	90	0.002	0.005
20015-0045	R0.075	0.45	30,000	350	0.005	0.005	30,000	270	0.004	0.005	30,000	200	0.003	0.005
20015-0075		0.75	30,000	220	0.004	0.005	30,000	160	0.004	0.005	30,000	100	0.003	0.005
2002-003	R0.1	0.3	30,000	660	0.005	0.005	30,000	550	0.005	0.005	30,000	440	0.005	0.005
2002-006		0.6	30,000	500	0.005	0.005	30,000	400	0.005	0.005	30,000	300	0.005	0.005
2002-010		1	30,000	290	0.005	0.005	30,000	200	0.005	0.005	30,000	120	0.005	0.005
2003-005	R0.15	0.5	30,000	1,000	0.005	0.005	30,000	950	0.005	0.005	30,000	620	0.005	0.005
2003-0075		0.75	30,000	850	0.005	0.005	30,000	800	0.005	0.005	30,000	500	0.005	0.005
2003-009		0.9	30,000	760	0.005	0.005	30,000	600	0.005	0.005	30,000	430	0.005	0.005
2003-015		1.5	30,000	460	0.005	0.005	30,000	320	0.005	0.005	30,000	190	0.005	0.005
2004-005	R0.2	0.5	30,000	1,580	0.005	0.01	30,000	1,330	0.005	0.01	30,000	860	0.005	0.005
2004-0075		0.75	30,000	1,390	0.005	0.01	30,000	1,140	0.005	0.01	30,000	800	0.005	0.005
2004-010		1	30,000	1,200	0.005	0.01	30,000	950	0.005	0.01	30,000	730	0.005	0.005
2004-012		1.2	30,000	1,050	0.005	0.01	30,000	800	0.005	0.01	30,000	620	0.005	0.005
2004-020		2	30,000	600	0.005	0.01	30,000	450	0.005	0.01	30,000	330	0.005	0.005
2004-030		3	20,000	400	0.005	0.005	20,000	300	0.005	0.005	20,000	190	0.003	0.003
2005-010	R0.25	1	30,000	1,600	0.01	0.01	30,000	1,300	0.01	0.01	30,000	920	0.005	0.01
2005-015		1.5	30,000	1,300	0.01	0.01	30,000	1,000	0.01	0.01	30,000	760	0.005	0.01
2005-025		2.5	30,000	800	0.01	0.01	30,000	700	0.01	0.01	30,000	480	0.005	0.01
2005-035		3.5	22,000	550	0.01	0.01	22,000	500	0.005	0.01	22,000	330	0.005	0.005
2006-010	R0.3	1	30,000	2,400	0.02	0.03	30,000	1,900	0.02	0.03	30,000	1,080	0.01	0.02
2006-015		1.5	30,000	2,000	0.02	0.03	30,000	1,500	0.02	0.03	30,000	1,000	0.01	0.02
2006-030		3	26,000	1,100	0.02	0.02	26,000	900	0.02	0.02	26,000	760	0.01	0.01
2006-040		4	22,000	750	0.01	0.02	22,000	650	0.01	0.02	22,000	570	0.005	0.01
2006-050		5	18,000	550	0.01	0.01	18,000	450	0.01	0.01	18,000	410	0.005	0.005
2006-060		6	12,000	350	0.005	0.01	12,000	290	0.005	0.005	12,000	260	0.003	0.003
2008-020	R0.4	2	30,000	2,500	0.02	0.03	30,000	2,100	0.02	0.03	30,000	1,700	0.01	0.02
2008-040		4	25,000	1,500	0.02	0.02	25,000	1,350	0.02	0.02	25,000	1,200	0.01	0.01
2008-060		6	18,000	1,000	0.01	0.02	18,000	800	0.01	0.02	18,000	750	0.005	0.01
2010-015	R0.5	1.5	30,000	3,700	0.04	0.05	30,000	3,400	0.03	0.04	30,000	2,300	0.025	0.03
2010-020		2	30,000	3,500	0.04	0.04	30,000	3,200	0.03	0.04	30,000	2,200	0.02	0.03
2010-025		2.5	30,000	3,300	0.04	0.04	30,000	3,000	0.03	0.04	30,000	2,100	0.02	0.03
2010-040		4	27,000	2,700	0.03	0.04	27,000	2,300	0.03	0.03	27,000	1,800	0.02	0.02
2010-050		5	23,000	2,200	0.03	0.03	23,000	1,800	0.03	0.03	23,000	1,450	0.02	0.02
2010-060		6	20,000	1,900	0.02	0.03	20,000	1,500	0.02	0.03	20,000	1,200	0.01	0.02
2010-080		8	14,000	1,300	0.01	0.02	14,000	1,000	0.01	0.02	14,000	800	0.01	0.01
2010-100		10	9,000	800	0.01	0.02	9,000	600	0.01	0.01	9,000	490	0.005	0.005

UDC Series

CBN Series

Square
Long Neck Square

Radius
Long Neck Radius
Taper Neck Radius

Ball / Long Shark Ball
Long Neck Ball
Taper Neck Ball

Taper

Spiral V Cutter

Drill

EURO Series

Technical Data

Milling Conditions for CBN-LBF

WORK MATERIAL			HEAT-TREATED STEELS / HARDENED STEELS STAVAX (~52HRC)				HARDENED STEELS SKD11 (~62HRC)				HARDENED STEELS HAP10 / HAP72 (~68HRC)				
Model Number	Radius of Ball Nose (mm)	Effective Length (mm)	Spindle Speed (min ⁻¹)	Feed Rate (mm/min)	a_p Axial Depth (mm)	a_e Radial Depth (mm)	Spindle Speed (min ⁻¹)	Feed Rate (mm/min)	a_p Axial Depth (mm)	a_e Radial Depth (mm)	Spindle Speed (min ⁻¹)	Feed Rate (mm/min)	a_p Axial Depth (mm)	a_e Radial Depth (mm)	
2012-024	R0.6	2.4	30,000	3,000	0.05	0.05	29,500	2,550	0.035	0.04	29,000	2,100	0.02	0.03	
2012-030		3	30,000	2,750	0.05	0.05	29,000	2,350	0.035	0.035	28,000	2,000	0.02	0.025	
2012-060		6	23,500	2,000	0.03	0.03	23,500	1,650	0.025	0.025	23,500	1,300	0.02	0.02	
2015-030	R0.75	3	30,000	3,000	0.07	0.07	28,500	2,550	0.045	0.05	27,000	2,100	0.02	0.03	
2015-040		4	28,500	2,750	0.06	0.06	27,250	2,300	0.04	0.04	26,000	1,900	0.02	0.025	
2015-060		6	26,000	2,200	0.04	0.045	25,500	1,900	0.03	0.03	25,000	1,650	0.02	0.02	
2015-080		8	24,000	2,000	0.025	0.03	24,000	1,700	0.02	0.025	24,000	1,400	0.015	0.02	
2015-100		10	16,000	1,300	0.02	0.02	16,000	1,100	0.015	0.018	16,000	900	0.01	0.015	
2015-120		12	12,000	1,000	0.016	0.018	12,000	880	0.012	0.016	12,000	730	0.008	0.012	
2015-150		15	6,000	600	0.01	0.015	6,000	550	0.008	0.012	6,000	490	0.005	0.008	
2020-040		R1	4	30,000	3,000	0.1	0.1	27,000	2,550	0.06	0.065	24,000	2,100	0.02	0.03
2020-050			5	28,000	2,750	0.08	0.08	26,000	2,300	0.05	0.05	24,000	1,900	0.02	0.025
2020-060	6		27,000	2,500	0.05	0.06	25,500	2,050	0.035	0.04	24,000	1,650	0.015	0.025	
2020-080	8		25,000	2,200	0.035	0.045	24,500	1,800	0.025	0.03	24,000	1,400	0.015	0.02	
2020-100	10		24,000	2,000	0.02	0.03	24,000	1,600	0.015	0.025	24,000	1,200	0.01	0.02	
2020-120	12		19,500	1,600	0.017	0.025	19,500	1,300	0.013	0.021	19,500	1,000	0.009	0.017	
2020-140	14		15,000	1,250	0.015	0.02	15,000	1,050	0.012	0.018	15,000	850	0.008	0.015	
2020-160	16		11,500	990	0.013	0.017	11,500	860	0.011	0.015	11,500	730	0.007	0.013	
2020-180	18		8,000	740	0.012	0.013	8,000	670	0.009	0.013	8,000	610	0.006	0.012	
2020-200	20		4,500	490	0.01	0.01	4,500	490	0.008	0.01	4,500	490	0.005	0.01	

a_p : Axial Depth (mm)
 a_e : Radial Depth (mm)

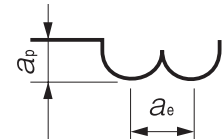

Note:

- Decrease both spindle speed and feed rate proportionally when the milling parameters exceed the machine's maximum spindle speed.
- Recommend oil mist to avoid tool damage.

* Refer to page 588 for tool geometry.

UDC Series

CBN Series

Square

Long Neck Square

Radius

Long Neck Radius

Taper Neck Radius

Ball / Long Shank Ball

Long Neck Ball

Taper Neck Ball

Taper

Spiral V Cutter

Drill

EURO Series

Technical Data

Milling example of convex shape for consecutive finishing
 CBN-LBF R0.3 × Effective Length 1.5

STAVAX (52HRC)

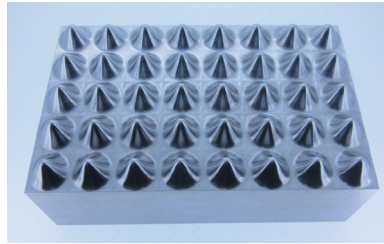

Work Size : 80 × 50 × 30 mm
 Coolant : Oil Mist

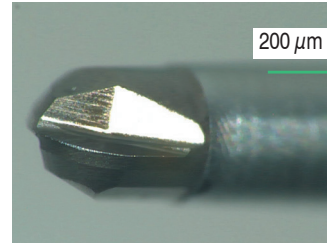

Tool damage after 10 hours of milling.

No	Milling Process	Milling Method	Tool	Spindle Speed (min ⁻¹)	Feed Rate (mm/min)	a _p Axial Depth (mm)	a _e Radial Depth (mm)	Cycle Time
1	Roughing	Contour milling	CFB 3030-0450 (R1.5 × Length of cut 4.5)	16,000	1,500	0.6	1.2	0:28:44
2	Semi-finishing	Contour spiral milling	CFB 3030-0450 (R1.5 × Length of cut 4.5)	28,600	2,300	0.004 (Cusp Height)	0.15	0:35:48
3	Semi-finishing	Contour spiral milling	CSEB 2020-0300 (R1 × Length of cut 3)	16,000	1,300	0.004 (Cusp Height)	0.05	2:18:42
4	Semi-finishing	Contour spiral milling	CSELB 2006-010 (R0.3 × Effective Length 1)	30,000	1,300	0.001 (Cusp Height)	0.06	3:44:47
5	Finishing	Contour spiral milling	CBN-LBF 2006-015 (R0.3 × Effective Length 1.5)	30,000	800	0.0001 (Cusp Height)	0.015	9:48:02
Total								16:56:03

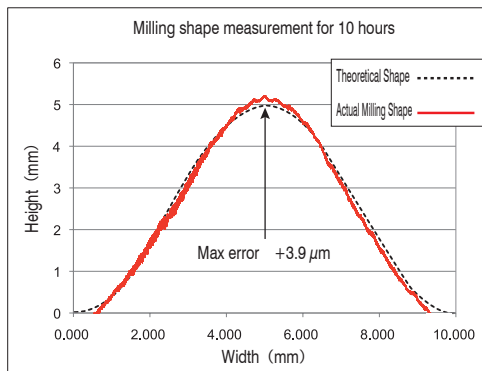

Excellent finishing shape for 10 hours of milling.

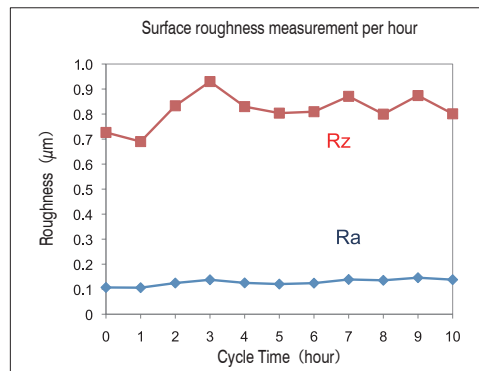

Constant surface roughness throughout the long cycle time.



CBN-LBF Convex shape for Consecutive Finishing Milling Video

UDC Series

CBN Series

Square
 Long Neck Square

Radius
 Long Neck Radius

Taper Neck Radius

Ball / Long Shark Ball
 Long Neck Ball

Taper Neck Ball

Taper

Spiral V Cutter

Drill

EURO Series

Technical Data

Finishing of reflector mold CBN-LBF R0.4 × Effective Length 2

STAVAX (52HRC)

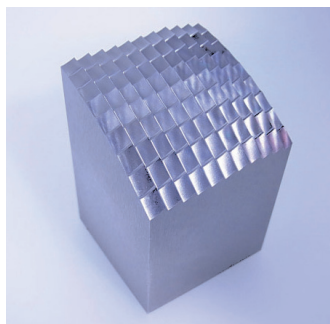

Work Size : 35 × 35 × 50 mm
Coolant : Air Blow
(For finishing : Oil Mist)

Tool damage after milling 10 hours

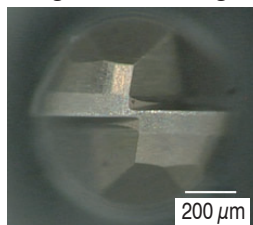

**Less tool damage and
uniform milling surface**

CBN-LBF
Reflector Mold for
Finishing Milling
Video



No	Milling Process	Tool	Spindle Speed (min ⁻¹)	Feed Rate (mm/min)	a_p Axial Depth (mm)	a_e Radial Depth (mm)	Cycle Time
1	Roughing	HRRS 4060-10-18S ($\phi 6 \times CR1 \times$ Effective Length 18)	3,500	2,500	0.2	2	0:18:00
2	Semi-roughing	HRRS 4060-10-18S ($\phi 6 \times CR1 \times$ Effective Length 18)	9,000	2,500	0.05	0.1	0:13:35
3	Semi-roughing	HRRS 4020-03-06S ($\phi 2 \times CR0.3 \times$ Effective Length 6)	3,500	1,000	0.04	1	0:33:55
4	Semi-finishing	HSB 2030-0800 (R1.5 × Length of Cut 8)	12,000	2,500	0.02	0.07	0:12:24
5	Semi-finishing	HSB 2015-0200 (R0.75 × Length of Cut 2)	7,000	1,000	0.04	0.07	0:20:50
6	Semi-finishing	HSB 2015-0200 (R0.75 × Length of Cut 2)	7,000	700	0.05	0.05	0:18:08
7	Semi-finishing	HSB 2010-0250 (R0.5 × Length of Cut 2.5)	8,000	500	0.02	0.03	0:23:24
8	Semi-finishing	HSB 2010-0250 (R0.5 × Length of Cut 2.5)	15,000	1,200	0.02	0.03	1:30:33
9	Finishing	CBN-LBF 2008-020 (R0.4 × Effective Length 2)	26,000	800	0.01	0.004	10:12:54

Total 14:03:43

UDC Series

CBN Series

Square

Long Neck Square

Radius

Radius

Long Neck Radius

Taper Neck Radius

Ball / Long Shank Ball

Ball

Long Neck Ball

Taper Neck Ball

Taper

Spiral V Cutter

Drill

EURO Series

Technical Data



Size $\phi 0.2 \sim \phi 2$

CBN-RSF

Patent pending

NEW



CR ≤ 0.02 CR ≥ 0.05

Material Applications (☆ Highly Recommended ○ Recommended ○ Suggested)

Work Material															
Carbon Steels S45C S55C	Alloy Steels SK / SCM SUS	Prehardened Steels NAK HPM	Hardened Steels			Cast Iron	Aluminum Alloys	Graphite	Copper	Plastics	Glass Filled Plastics	Titanium Alloys	Heat Resistant Alloys	Cemented Carbide	Hard Brittle (Non-Metallic) Materials
			~55HRC	~60HRC	~70HRC										
				○	○										
					○										

Features

Optimized CBN material for milling of ultra-hard materials and the improved cutting edge geometry enables high precision milling and long tool life. Excellent wear resistance and chipping resistance ensures an outstanding surface roughness and precision throughout the long cycle time.

High precision shank diameter tolerance of 0/-0.004 mm.

CBN-RSF : Diameter tolerance 0/-0.005 mm. High precision corner R and super finishing.

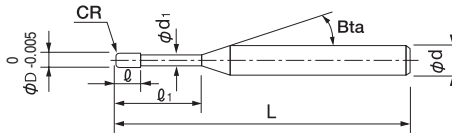

The shank taper angle shown is not an exact value and to avoid contact with the work piece, we recommend the user controls the precise value of this angle. Shank taper angle should not make contact with the work piece.

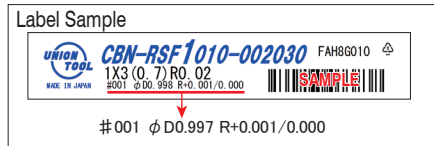

Diameter and Corner R accuracy measurements are printed on the label to support High Precision milling.

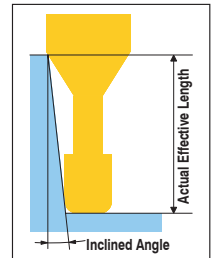

Total 42 models

*Shank taper angle Bta is only for reference.

Unit (mm)

Model Number	Outside Diameter ϕD	Corner Radius CR	Effective Length ℓ_1	Length of Cut ℓ	Neck Diameter ϕd	Shank Taper Angle Bta	Overall Length L	Shank Diameter ϕd	Price ¥	Effective Length by Inclined Angles				
										30°	1°	1°30'	2°	3°
CBN-RSF 1002-002003	0.2	RO.02	0.3	0.08	0.19	15°	50	4	36,600	0.30	0.30	0.30	0.31	0.34
CBN-RSF 1002-002005			0.5							0.50	0.50	0.52	0.54	0.59
CBN-RSF 1002-005003		RO.05	0.3							0.30	0.30	0.30	0.31	0.33
CBN-RSF 1002-005005			0.5							0.50	0.50	0.52	0.54	0.58
CBN-RSF 1003-002005	0.3	RO.02	0.5	0.13	0.28	15°	50	4	36,200	0.51	0.53	0.55	0.57	0.62
CBN-RSF 1003-002010			1							1.03	1.07	1.11	1.15	1.25
CBN-RSF 1003-005005		RO.05	0.5							0.51	0.53	0.55	0.57	0.62
CBN-RSF 1003-005010			1							1.03	1.07	1.10	1.15	1.24

Unit (mm)

Model Number	Outside Diameter ϕD	Corner Radius CR	Effective Length l_1	Length of Cut l	Neck Diameter ϕd_1	Shank Taper Angle Bta	Overall Length L	Shank Diameter ϕd	Price ¥	Effective Length by Inclined Angles								
										30°	1°	1°30'	2°	3°				
CBN-RSF 1004-002005	0.4	RO.02	0.5	0.24	0.38	15°	50	4	34,300	0.51	0.53	0.55	0.57	0.62				
CBN-RSF 1004-002015			1.5				50	4	35,000	1.54	1.59	1.65	1.71	1.86				
CBN-RSF 1004-005005		RO.05	0.5				50	4	30,900	0.51	0.53	0.55	0.57	0.62				
CBN-RSF 1004-005015			1.5				50	4	31,100	1.54	1.59	1.65	1.71	1.85				
CBN-RSF 1005-002005	0.5	RO.02	0.5	0.3	0.48	15°	50	4	28,200	0.51	0.53	0.55	0.57	0.62				
CBN-RSF 1005-002015			1.5				50	4	28,700	1.54	1.59	1.65	1.71	1.86				
CBN-RSF 1005-005005		RO.05	0.5				50	4	25,400	0.51	0.53	0.55	0.57	0.62				
CBN-RSF 1005-005015			1.5				50	4	25,800	1.54	1.59	1.65	1.71	1.85				
CBN-RSF 1006-002010	0.6	RO.02	1	0.3	0.58	15°	50	4	28,500	1.03	1.07	1.11	1.15	1.25				
CBN-RSF 1006-002015			1.5				50	4	28,700	1.54	1.59	1.65	1.71	1.86				
CBN-RSF 1006-005010		RO.05	1				50	4	25,600	1.03	1.07	1.10	1.15	1.24				
CBN-RSF 1006-005015			1.5				50	4	25,800	1.54	1.59	1.65	1.71	1.85				
CBN-RSF 1008-002010	0.8	RO.02	1	0.56	0.78	15°	50	4	28,700	1.03	1.07	1.11	1.15	1.25				
CBN-RSF 1008-002020			2				50	4	28,700	2.05	2.13	2.20	2.29	2.48				
CBN-RSF 1008-005010		RO.05	1				50	4	25,800	1.03	1.07	1.10	1.15	1.24				
CBN-RSF 1008-005020			2				50	4	25,800	2.05	2.12	2.20	2.28	2.47				
CBN-RSF 1010-002010	1	RO.02	1	0.7	0.98	15°	50	4	26,400	1.03	1.07	1.11	1.15	1.25				
CBN-RSF 1010-002020			2				50	4	26,400	2.07	2.14	2.22	2.30	2.49				
CBN-RSF 1010-002030			3				50	4	26,400	3.10	3.21	3.33	3.45	3.73				
CBN-RSF 1010-005010		RO.05	1				50	4	23,700	1.03	1.07	1.11	1.15	1.24				
CBN-RSF 1010-005020			2				50	4	23,700	2.06	2.14	2.21	2.30	2.48				
CBN-RSF 1010-005030			3				50	4	23,700	3.10	3.21	3.32	3.45	3.73				
CBN-RSF 1010-010010		RO.1	1				50	4	23,700	1.03	1.06	1.10	1.14	1.23				
CBN-RSF 1010-010020			2				50	4	23,700	2.06	2.13	2.21	2.29	2.47				
CBN-RSF 1010-010030			3				50	4	23,700	3.10	3.20	3.32	3.44	3.72				
CBN-RSF 1015-002030		1.5	RO.02				3	1	1.46	15°	50	4	31,000	3.14	3.25	3.37	3.49	3.78
CBN-RSF 1015-005030			RO.05				3				50	4	27,900	3.14	3.25	3.36	3.49	3.77
CBN-RSF 1015-010030			RO.1				3				50	4	27,900	3.14	3.24	3.36	3.48	3.76
CBN-RSF 1020-002040	2	RO.02	4	1.2	1.97	15°	50	4	32,000	4.15	4.30	4.45	4.62	5.00				
CBN-RSF 1020-002060			6				50	4	32,000	6.22	6.44	6.67	6.92	7.49				
CBN-RSF 1020-005040		RO.05	4				50	4	28,700	4.15	4.30	4.45	4.62	4.99				
CBN-RSF 1020-005060			6				50	4	28,700	6.22	6.44	6.67	6.92	7.48				
CBN-RSF 1020-010040		RO.1	4				50	4	28,700	4.15	4.29	4.45	4.61	4.98				
CBN-RSF 1020-010060			6				50	4	28,700	6.22	6.43	6.66	6.91	7.47				

UDC Series

CBN Series

Square

Square

Long Neck Square

Radius

Radius

Long Neck Radius

Taper Neck Radius

Ball / Long Shank Ball

Ball

Long Neck Ball

Taper Neck Ball

Taper

Spiral V Cutter

Drill

EURO Series

Technical Data

Milling Conditions for CBN-RSF

WORK MATERIAL				HARDENED STEELS ELMAX (58~62HRC)				HARDENED STEELS HAP10 (62~65HRC)			
Model Number	Outside Diameter (mm)	Corner Radius (mm)	Effective Length (mm)	Spindle Speed (min ⁻¹)	Feed Rate (mm/min)	a_p Axial Depth (mm)	a_e Radial Depth (mm)	Spindle Speed (min ⁻¹)	Feed Rate (mm/min)	a_p Axial Depth (mm)	a_e Radial Depth (mm)
1002-002003	0.2	R0.02	0.3	60,000	80 MAX	0.003	0.01	60,000	20 MAX	0.003	0.005
1002-002005			0.5	60,000	80 MAX	0.003	0.01	60,000	20 MAX	0.003	0.005
1002-005003		R0.05	0.3	60,000	80 MAX	0.003	0.01	60,000	20 MAX	0.003	0.005
1002-005005			0.5	60,000	80 MAX	0.003	0.01	60,000	20 MAX	0.003	0.005
1003-002005	0.3	R0.02	0.5	40,000	80 MAX	0.004	0.015	40,000	20 MAX	0.004	0.005
1003-002010			1	40,000	80 MAX	0.004	0.015	40,000	20 MAX	0.004	0.005
1003-005005		R0.05	0.5	40,000	80 MAX	0.004	0.015	40,000	20 MAX	0.004	0.005
1003-005010			1	40,000	80 MAX	0.004	0.015	40,000	20 MAX	0.004	0.005
1004-002005	0.4	R0.02	0.5	30,000	80 MAX	0.005	0.02	30,000	20 MAX	0.005	0.006
1004-002015			1.5	30,000	80 MAX	0.005	0.02	30,000	20 MAX	0.005	0.006
1004-005005		R0.05	0.5	30,000	100 MAX	0.005	0.02	30,000	60 MAX	0.005	0.02
1004-005015			1.5	30,000	100 MAX	0.005	0.02	30,000	60 MAX	0.005	0.02
1005-002005	0.5	R0.02	0.5	30,000	90 MAX	0.005	0.025	30,000	25 MAX	0.005	0.008
1005-002015			1.5	30,000	90 MAX	0.005	0.025	30,000	25 MAX	0.005	0.008
1005-005005		R0.05	0.5	30,000	100 MAX	0.01	0.025	30,000	60 MAX	0.01	0.025
1005-005015			1.5	30,000	100 MAX	0.01	0.025	30,000	60 MAX	0.01	0.025
1006-002010	0.6	R0.02	1	30,000	100 MAX	0.005	0.03	30,000	30 MAX	0.005	0.01
1006-002015			1.5	30,000	100 MAX	0.005	0.03	30,000	30 MAX	0.005	0.01
1006-005010		R0.05	1	30,000	110 MAX	0.01	0.03	30,000	65 MAX	0.01	0.03
1006-005015			1.5	30,000	110 MAX	0.01	0.03	30,000	65 MAX	0.01	0.03
1008-002010	0.8	R0.02	1	30,000	125 MAX	0.005	0.04	30,000	40 MAX	0.005	0.012
1008-002020			2	30,000	125 MAX	0.005	0.04	30,000	40 MAX	0.005	0.012
1008-005010		R0.05	1	30,000	140 MAX	0.01	0.04	30,000	85 MAX	0.01	0.04
1008-005020			2	30,000	140 MAX	0.01	0.04	30,000	85 MAX	0.01	0.04
1010-002010	1	R0.02	1	30,000	150 MAX	0.005	0.05	30,000	50 MAX	0.005	0.015
1010-002020			2	30,000	150 MAX	0.005	0.05	30,000	50 MAX	0.005	0.015
1010-002030			3	30,000	150 MAX	0.005	0.05	30,000	50 MAX	0.005	0.015
1010-005010		R0.05	1	30,000	165 MAX	0.01	0.05	30,000	100 MAX	0.01	0.04
1010-005020			2	30,000	165 MAX	0.01	0.05	30,000	100 MAX	0.01	0.04
1010-005030			3	30,000	165 MAX	0.01	0.05	30,000	100 MAX	0.01	0.04
1010-010010		R0.1	1	30,000	185 MAX	0.01	0.05	30,000	150 MAX	0.01	0.05
1010-010020			2	30,000	185 MAX	0.01	0.05	30,000	150 MAX	0.01	0.05
1010-010030			3	30,000	185 MAX	0.01	0.05	30,000	150 MAX	0.01	0.05

Milling Conditions for CBN-RSF

WORK MATERIAL				HARDENED STEELS ELMAX (58~62HRC)				HARDENED STEELS HAP10 (62~65HRC)			
Model Number	Outside Diameter (mm)	Corner Radius (mm)	Effective Length (mm)	Spindle Speed (min ⁻¹)	Feed Rate (mm/min)	a_p Axial Depth (mm)	a_e Radial Depth (mm)	Spindle Speed (min ⁻¹)	Feed Rate (mm/min)	a_p Axial Depth (mm)	a_e Radial Depth (mm)
1015-002030	1.5	R0.02	3	30,000	225 MAX	0.005	0.075	30,000	75 MAX	0.005	0.025
1015-005030		R0.05	3	30,000	250 MAX	0.01	0.075	30,000	150 MAX	0.01	0.05
1015-010030		R0.1	3	30,000	280 MAX	0.01	0.075	30,000	225 MAX	0.01	0.075
1020-002040	2	R0.02	4	30,000	300 MAX	0.005	0.1	30,000	100 MAX	0.005	0.03
1020-002060			6	30,000	300 MAX	0.005	0.1	30,000	100 MAX	0.005	0.03
1020-005040		R0.05	4	30,000	330 MAX	0.01	0.1	30,000	200 MAX	0.01	0.07
1020-005060			6	30,000	330 MAX	0.01	0.1	30,000	200 MAX	0.01	0.07
1020-010040		R0.1	4	30,000	375 MAX	0.01	0.1	30,000	300 MAX	0.01	0.1
1020-010060			6	30,000	375 MAX	0.01	0.1	30,000	300 MAX	0.01	0.1

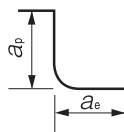

a_p : Axial Depth (mm)
 a_e : Radial Depth (mm)

Note:

- Decrease both spindle speed and feed rate proportionally when the milling parameters exceed the machine's maximum spindle speed.
- Recommend oil mist to avoid tool damage.

UDC Series

CBN Series

Square

Long Neck Square

Radius

Radius

Long Neck Radius

Taper Neck Radius

Ball / Long Shank Ball

Ball

Long Neck Ball

Taper Neck Ball

Taper

Taper

Spiral V Cutter

Drill

EURO Series

Technical Data

Milling example of inclined pocket
CBN-RSF $\phi 2 \times CR0.1 \times$ Effective Length 4

ELMAX (60.5HRC)

Vertical Wall

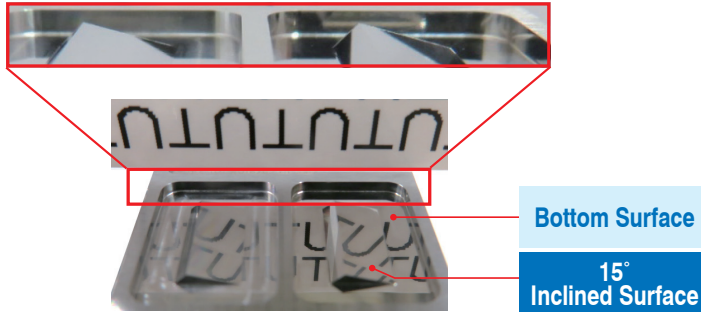

Bottom Surface

15°
Inclined Surface

CBN-LRF
(Conventional)

CBN-RSF

Milled Size : $9 \times 13 \times$ Depth 1 mm
 Coolant : Oil Mist

Bottom Surface Roughness

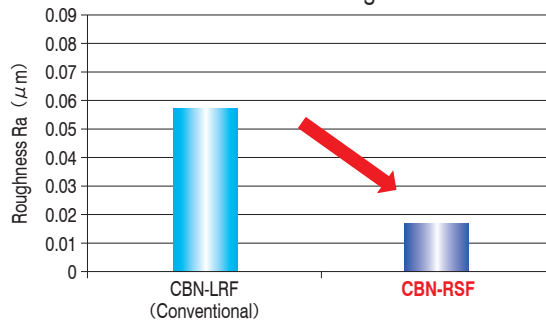

Tool	CBN-RSF 1020-010040
Process	Finishing
Milling Method	Contour Milling
Spindle Speed	$30,000 \text{ min}^{-1}$
Feed Rate	375 mm/min
Finishing Allowance	0.01 mm
Cusp Height at Inclined Surface	0.00003 mm
Cycle Time	61 min

Improved quality for milling on the bottom, inclined and vertical surfaces as compared to conventional CBN-LRF series.

UDC Series

CBN Series

Square

Long Neck Square

Radius

Long Neck Radius

Taper Neck Radius

Ball / Long Shank Ball

Long Neck Ball

Taper Neck Ball

Taper

Spiral V Cutter

Drill

EURO Series

Technical Data

Milling example of pocket

CBN-RSF $\phi 2 \times CR0.1 \times$ Effective Length 4

ELMAX (60HRC)

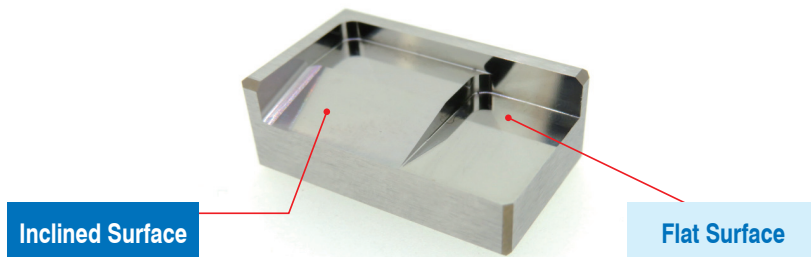

Work Size : 25 × 15 × 10 mm
Coolant : Oil Mist

Surface Roughness

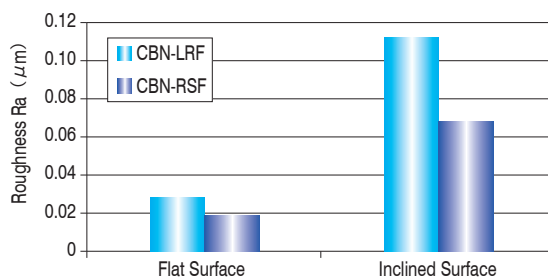

No.	Process	Tool	Spindle Speed (min ⁻¹)	Feed Rate (mm/min)	a_p Axial Depth (mm)	a_e Radial Depth (mm)	Allowance (mm)	Cycle Time
1	Roughing	HGLB 2020-040 (R1 x Effective Length 4)	14,000	2,100	0.15	0.5	0.05	0:10:17
2	Semi-finishing	HLRS 4020-01-040 ($\phi 2 \times CR0.1 \times$ Effective Length 4)	11,500	860	0.031	0.36	0.05	1:11:50
					0.02	0.36	0.02	
					0.005	0.1	0.01	
3	Finishing	CBN-RSF 1020-010040 ($\phi 2 \times CR0.1 \times$ Effective Length 4)	30,000	375	0.01	0.1	0	2:25:01

Total 3:47:08

UDC Series

CBN Series

Square
Long Neck SquareRadius
Long Neck Radius

Taper Neck Radius

Ball / Long Shank Ball

Long Neck Ball

Taper Neck Ball

Taper

Spiral V Cutter

Drill

EURO Series

Technical Data



Size $\phi 0.1 \sim \phi 2$

CBN-LRF



CR ≤ 0.03

CR > 0.03

Material Applications (☆ Highly Recommended ● Recommended ○ Suggested)

Work Material															
Carbon Steels S45C S55C	Alloy Steels SK / SCM SUS	Prehardened Steels NAK HPM	Hardened Steels			Cast Iron	Aluminum Alloys	Graphite	Copper	Plastics	Glass Filled Plastics	Titanium Alloys	Heat Resistant Alloys	Cemented Carbide	Hard Brittle (Non-Metallic) Materials
			~55HRC	~60HRC	~70HRC										
		○	●	●	○										

Features

Optimized CBN material for milling the ultra-hard materials and cutting edge geometry offer high precision milling and long tool life. Excellent wear and chipping resistance maintain outstanding surface roughness and precision throughout the long cycle time. High precision shank diameter tolerance 0/-0.004 mm. Diameter tolerance 0/-0.008 mm, with highly precision corner radius.

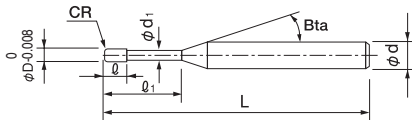

The shank taper angle shown is not an exact value and to avoid contact with the work piece, we recommend the user controls the precise value of this angle. Shank taper angle should not make contact with the work piece.

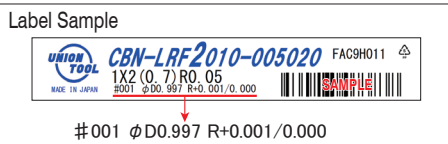

Diameter and Corner R accuracy measurements are printed on the label to support High Precision milling.

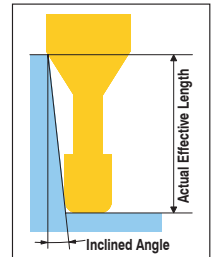

Total 139 models

*Shank taper angle Bta is only for reference.

Unit (mm)

Model Number	Outside Diameter ϕD	Corner Radius CR	Effective Length ℓ_1	Length of Cut ℓ	Neck Diameter ϕd_1	Shank Taper Angle Bta	Overall Length L	Shank Diameter ϕd	Price ¥	Effective Length by Inclined Angles					
										30°	1°	1°30'	2°	3°	
CBN-LRF 2001-002002	0.1	RO.02	0.2	0.04	0.09	15°	50	4	44,500	0.20	0.20	0.20	0.20	0.21	
CBN-LRF 2001-002003			0.3				50	4	45,200	0.30	0.30	0.30	0.30	0.33	
CBN-LRF 2001-002005			0.5				50	4	46,500	0.50	0.50	0.51	0.53	0.58	
CBN-LRF 2001-003002		0.2	RO.03				0.2	50	4	42,500	0.20	0.20	0.20	0.20	0.21
CBN-LRF 2001-003003		0.3					50	4	43,200	0.30	0.30	0.30	0.30	0.33	
CBN-LRF 2001-003005		0.5					50	4	44,500	0.50	0.50	0.51	0.53	0.58	
CBN-LRF 20015-002X2	0.15	RO.02	0.2	0.06	0.14	15°	50	4	44,500	0.20	0.20	0.20	0.20	0.21	
CBN-LRF 20015-002X3			0.3				50	4	45,200	0.30	0.30	0.30	0.30	0.33	
CBN-LRF 20015-002X5			0.5				50	4	46,500	0.50	0.50	0.51	0.53	0.58	
CBN-LRF 20015-003X2		0.2	RO.03				0.2	50	4	42,500	0.20	0.20	0.20	0.20	0.21
CBN-LRF 20015-003X3		0.3					50	4	43,200	0.30	0.30	0.30	0.30	0.33	
CBN-LRF 20015-003X5		0.5					50	4	44,500	0.50	0.50	0.51	0.53	0.58	

Model Number	Outside Diameter ϕD	Corner Radius CR	Effective Length ℓ_1	Length of Cut ℓ	Neck Diameter ϕd_1	Shank Taper Angle Bta	Overall Length L	Shank Diameter ϕd	Price ¥	Effective Length by Inclined Angles									
										30°	1°	1°30'	2°	3°					
CBN-LRF 2002-002005	0.2	RO.02	0.5	0.08	0.19	15°	50	4	33,900	0.50	0.50	0.51	0.53	0.58					
CBN-LRF 2002-002X75			0.75				50	4	34,400	0.75	0.76	0.79	0.82	0.89					
CBN-LRF 2002-002010			1				50	4	34,900	1.00	1.03	1.07	1.11	1.20					
CBN-LRF 2002-003005		RO.03	0.5				50	4	30,500	0.50	0.50	0.51	0.53	0.58					
CBN-LRF 2002-003X75			0.75				50	4	30,900	0.75	0.76	0.79	0.82	0.89					
CBN-LRF 2002-003010			1				50	4	31,400	1.00	1.03	1.07	1.11	1.20					
CBN-LRF 2002-005005		RO.05	0.5				50	4	30,500	0.50	0.50	0.51	0.53	0.57					
CBN-LRF 2002-005X75			0.75				50	4	30,900	0.75	0.76	0.79	0.82	0.88					
CBN-LRF 2002-005010			1				50	4	31,400	1.00	1.03	1.06	1.10	1.19					
CBN-LRF 20025-005X5			0.5				50	4	30,500	0.50	0.50	0.51	0.53	0.57					
CBN-LRF 20025-X5X75	0.25	RO.05	0.75	0.1	0.24	15°	50	4	30,900	0.75	0.76	0.79	0.82	0.88					
CBN-LRF 20025-X5010			1				50	4	31,400	1.00	1.03	1.06	1.10	1.19					
CBN-LRF 2003-001010	0.3	RO.01	1	0.13	0.28	15°	50	4	33,900	1.02	1.06	1.10	1.14	1.24					
CBN-LRF 2003-002005		RO.02	0.5				50	4	33,500	0.51	0.53	0.55	0.57	0.62					
CBN-LRF 2003-002X75			0.75				50	4	33,700	0.77	0.79	0.82	0.86	0.93					
CBN-LRF 2003-002010			1				50	4	33,900	1.02	1.06	1.10	1.14	1.24					
CBN-LRF 2003-002015		RO.03	1.5				50	4	34,400	1.54	1.60	1.65	1.72	1.86					
CBN-LRF 2003-002020			2				50	4	34,900	2.05	2.12	2.20	2.28	2.47					
CBN-LRF 2003-003005			0.5				50	4	30,100	0.51	0.53	0.55	0.57	0.62					
CBN-LRF 2003-003X75		RO.05	0.75				50	4	30,300	0.77	0.79	0.82	0.85	0.93					
CBN-LRF 2003-003010			1				50	4	30,500	1.02	1.06	1.10	1.14	1.24					
CBN-LRF 2003-003015			1.5				50	4	30,900	1.54	1.60	1.65	1.72	1.86					
CBN-LRF 2003-003020			2				50	4	31,300	2.05	2.12	2.20	2.28	2.47					
CBN-LRF 2003-005005		RO.05	0.5				50	4	30,100	0.51	0.52	0.54	0.56	0.61					
CBN-LRF 2003-005X75			0.75				50	4	30,300	0.76	0.79	0.82	0.85	0.92					
CBN-LRF 2003-005010			1				50	4	30,500	1.02	1.06	1.10	1.14	1.23					
CBN-LRF 2003-005015			1.5				50	4	30,900	1.54	1.59	1.65	1.71	1.85					
CBN-LRF 2003-005020			2				50	4	31,300	2.05	2.12	2.20	2.28	2.46					
CBN-LRF 2004-002005			0.4				RO.02	0.5	0.24	0.38	15°	50	4	31,800	0.51	0.53	0.55	0.57	0.62
CBN-LRF 2004-002010								1				50	4	32,000	1.02	1.06	1.10	1.14	1.24
CBN-LRF 2004-002015								1.5				50	4	32,400	1.53	1.59	1.64	1.71	1.85
CBN-LRF 2004-002020		2						50				4	32,800	2.05	2.12	2.20	2.28	2.47	
CBN-LRF 2004-003005	RO.03	0.5		50	4	28,600	0.51	0.53				0.55	0.57	0.62					
CBN-LRF 2004-003010		1		50	4	28,800	1.02	1.06				1.10	1.14	1.24					
CBN-LRF 2004-003015		1.5		50	4	28,800	1.53	1.59				1.64	1.71	1.85					
CBN-LRF 2004-005005	RO.05	0.5		50	4	28,600	0.51	0.52				0.54	0.56	0.61					
CBN-LRF 2004-005010		1		50	4	28,800	1.02	1.06				1.10	1.14	1.23					
CBN-LRF 2004-005015		1.5		50	4	28,800	1.53	1.58				1.64	1.70	1.84					
CBN-LRF 2004-005020		2	50	4	28,800	2.05	2.12	2.20	2.28	2.46									
CBN-LRF 2004-005040		4	50	4	29,800	4.11	4.26	4.41	4.58	4.95									
CBN-LRF 2004-010005		RO.1	0.5	50	4	28,600	0.50	0.52	0.54	0.56	0.60								
CBN-LRF 2004-010010	1		50	4	28,800	1.02	1.06	1.09	1.13	1.22									
CBN-LRF 2004-010015	1.5		50	4	28,800	1.53	1.58	1.64	1.70	1.83									

- UDC Series
- CBN Series
- Square
- Long Neck Square
- Radius
- Long Neck Radius
- Taper Neck Radius
- Ball / Long Shank Ball
- Long Neck Ball
- Taper Neck Ball
- Taper
- Spiral V Cutter
- Drill
- EURO Series
- Technical Data

Model Number	Outside Diameter ϕD	Corner Radius CR	Effective Length l_1	Length of Cut l	Neck Diameter ϕd_1	Shank Taper Angle Bta	Overall Length L	Shank Diameter ϕd	Price ¥	Effective Length by Inclined Angles					
										30°	1°	1°30'	2°	3°	
CBN-LRF 2005-001010	0.5	RO.01	1	0.3	0.48	15°	50	4	26,400	1.02	1.06	1.10	1.14	1.24	
CBN-LRF 2005-002005			RO.02				0.5	50	4	26,100	0.51	0.53	0.55	0.57	0.62
CBN-LRF 2005-002010							1	50	4	26,400	1.02	1.06	1.10	1.14	1.24
CBN-LRF 2005-002015		1.5					50	4	26,600	1.53	1.59	1.64	1.71	1.85	
CBN-LRF 2005-002020		2					50	4	26,800	2.05	2.12	2.20	2.28	2.47	
CBN-LRF 2005-003005		RO.03					0.5	50	4	23,500	0.51	0.53	0.55	0.57	0.62
CBN-LRF 2005-003010							1	50	4	23,700	1.02	1.06	1.10	1.14	1.24
CBN-LRF 2005-003015			1.5				50	4	23,900	1.53	1.59	1.64	1.71	1.85	
CBN-LRF 2005-003020		RO.05	2				50	4	24,100	2.05	2.12	2.20	2.28	2.47	
CBN-LRF 2005-005005			0.5				50	4	23,500	0.51	0.52	0.54	0.56	0.61	
CBN-LRF 2005-005010			1				50	4	23,700	1.02	1.06	1.10	1.14	1.23	
CBN-LRF 2005-005015			1.5				50	4	23,900	1.53	1.58	1.64	1.70	1.84	
CBN-LRF 2005-005020			2				50	4	24,100	2.05	2.12	2.20	2.28	2.46	
CBN-LRF 2005-010005			RO.1				0.5	50	4	23,500	0.50	0.52	0.54	0.56	0.60
CBN-LRF 2005-010010		1					50	4	23,700	1.02	1.06	1.09	1.13	1.22	
CBN-LRF 2005-010015		1.5					50	4	23,900	1.53	1.58	1.64	1.70	1.83	
CBN-LRF 2005-010020		2					50	4	24,100	2.05	2.12	2.19	2.27	2.45	
CBN-LRF 2006-002005		RO.02					0.5	50	4	26,100	0.51	0.53	0.55	0.57	0.62
CBN-LRF 2006-002010	1			50	4	26,400	1.02	1.06	1.10	1.14	1.24				
CBN-LRF 2006-002015	1.5		50	4	26,600	1.53	1.59	1.64	1.71	1.85					
CBN-LRF 2006-005005	RO.05		0.5	50	4	23,500	0.51	0.52	0.54	0.56	0.61				
CBN-LRF 2006-005010			1	50	4	23,700	1.02	1.06	1.10	1.14	1.23				
CBN-LRF 2006-005015			1.5	50	4	23,900	1.53	1.58	1.64	1.70	1.84				
CBN-LRF 2006-005030	RO.1	3	50	4	26,100	3.08	3.19	3.30	3.43	3.71					
CBN-LRF 2006-010005		0.5	50	4	23,500	0.50	0.52	0.54	0.56	0.60					
CBN-LRF 2006-010010		1	50	4	23,700	1.02	1.06	1.09	1.13	1.22					
CBN-LRF 2006-010015		1.5	50	4	23,900	1.53	1.58	1.64	1.70	1.83					
CBN-LRF 2008-002010		RO.02	1	50	4	26,600	1.02	1.06	1.10	1.14	1.24				
CBN-LRF 2008-002015			1.5	50	4	26,600	1.53	1.59	1.64	1.71	1.85				
CBN-LRF 2008-002020	2		50	4	26,600	2.05	2.12	2.20	2.28	2.47					
CBN-LRF 2008-002050	5		50	4	30,100	5.15	5.33	5.52	5.73	6.20					
CBN-LRF 2008-005010	RO.05		1	50	4	23,900	1.02	1.06	1.10	1.14	1.23				
CBN-LRF 2008-005015			1.5	50	4	23,900	1.53	1.58	1.64	1.70	1.84				
CBN-LRF 2008-005020		2	50	4	23,900	2.05	2.12	2.20	2.28	2.46					
CBN-LRF 2008-005050		5	50	4	27,000	5.15	5.33	5.52	5.73	6.19					
CBN-LRF 2008-010010		RO.1	1	50	4	23,900	1.02	1.06	1.09	1.13	1.22				
CBN-LRF 2008-010015			1.5	50	4	23,900	1.53	1.58	1.64	1.70	1.83				
CBN-LRF 2008-010020	2		50	4	23,900	2.05	2.12	2.19	2.27	2.45					
CBN-LRF 2008-010050	5		50	4	27,000	5.15	5.32	5.52	5.72	6.18					

UDC Series

CBN Series

Square
Long Neck Square

Radius

Long Neck Radius
Taper Neck Radius

Ball / Long Shank Ball
Long Neck Ball

Taper Neck Ball
Taper

Spiral V Cutter

Drill

EURO Series

Technical Data

Model Number	Outside Diameter ϕD	Corner Radius CR	Effective Length ℓ_1	Length of Cut ℓ	Neck Diameter ϕd_1	Shank Taper Angle Bta	Overall Length L	Shank Diameter ϕd	Price ¥	Effective Length by Inclined Angles								
										30°	1°	1°30'	2°	3°				
CBN-LRF 2010-002010	1	RO.02	1	0.7	0.98	15°	50	4	24,400	1.03	1.06	1.10	1.15	1.24				
CBN-LRF 2010-002020			2				50	4	24,400	2.06	2.13	2.21	2.30	2.48				
CBN-LRF 2010-002030			3				50	4	24,400	3.09	3.20	3.32	3.45	3.73				
CBN-LRF 2010-002050			5				50	4	27,600	5.16	5.34	5.54	5.74	6.21				
CBN-LRF 2010-005010		RO.05	1				50	4	21,900	1.03	1.06	1.10	1.14	1.23				
CBN-LRF 2010-005020			2				50	4	21,900	2.06	2.13	2.21	2.29	2.48				
CBN-LRF 2010-005030			3				50	4	21,900	3.09	3.20	3.32	3.44	3.72				
CBN-LRF 2010-005050			5				50	4	24,800	5.16	5.34	5.53	5.74	6.21				
CBN-LRF 2010-010010		RO.1	1				50	4	21,900	1.02	1.06	1.09	1.13	1.22				
CBN-LRF 2010-010020			2				50	4	21,900	2.06	2.13	2.20	2.28	2.47				
CBN-LRF 2010-010030			3				50	4	21,900	3.09	3.20	3.31	3.43	3.71				
CBN-LRF 2010-010050			5				50	4	24,800	5.16	5.34	5.53	5.73	6.20				
CBN-LRF 2010-020010		RO.2	1				50	4	21,900	1.02	1.05	1.08	1.12	1.20				
CBN-LRF 2010-020020			2				50	4	21,900	2.05	2.12	2.19	2.27	2.44				
CBN-LRF 2015-002030	1.5	RO.02	3	1	1.46	15°	50	4	28,700	3.13	3.24	3.36	3.49	3.77				
CBN-LRF 2015-002040			4				50	4	28,700	4.17	4.31	4.47	4.64	5.02				
CBN-LRF 2015-002060			6				50	4	28,700	6.23	6.45	6.69	6.94	7.50				
CBN-LRF 2015-005030		RO.05	3				50	4	25,800	3.13	3.24	3.36	3.48	3.77				
CBN-LRF 2015-005040			4				50	4	25,800	4.16	4.31	4.47	4.63	5.01				
CBN-LRF 2015-005060			6				50	4	25,800	6.23	6.45	6.68	6.93	7.50				
CBN-LRF 2015-010030		RO.1	3				50	4	25,800	3.13	3.24	3.35	3.48	3.76				
CBN-LRF 2015-010040			4				50	4	25,800	4.16	4.31	4.46	4.63	5.00				
CBN-LRF 2015-010060			6				50	4	25,800	6.23	6.45	6.68	6.93	7.48				
CBN-LRF 2015-030045		RO.3	4.5				50	4	25,800	4.67	4.83	4.99	5.17	5.57				
CBN-LRF 2020-002040		2	RO.02				4	1.2	1.97	15°	50	4	29,600	4.15	4.29	4.45	4.62	4.99
CBN-LRF 2020-002060							6				50	4	29,600	6.21	6.43	6.67	6.92	7.48
CBN-LRF 2020-002080							8				50	4	31,300	8.28	8.57	8.88	9.22	9.97
CBN-LRF 2020-002100							10				50	4	33,000	10.35	10.71	11.10	11.52	12.45
CBN-LRF 2020-003030	RO.03		3	50	4	26,600	3.11				3.22	3.34	3.47	3.75				
CBN-LRF 2020-005040	RO.05		4	50	4	26,600	4.15				4.29	4.45	4.61	4.99				
CBN-LRF 2020-005060			6	50	4	26,600	6.21				6.43	6.66	6.91	7.47				
CBN-LRF 2020-005080			8	50	4	28,150	8.28				8.57	8.88	9.21	9.96				
CBN-LRF 2020-005100			10	50	4	29,700	10.35				10.71	11.10	11.51	12.45				
CBN-LRF 2020-010040	RO.1		4	50	4	26,600	4.14				4.29	4.44	4.60	4.98				
CBN-LRF 2020-010060			6	50	4	26,600	6.21				6.43	6.66	6.90	7.46				
CBN-LRF 2020-010080			8	50	4	28,150	8.28				8.57	8.87	9.20	9.95				
CBN-LRF 2020-010100			10	50	4	29,700	10.35				10.70	11.09	11.50	12.43				
CBN-LRF 2020-020040			RO.2	4	50	4	26,600				4.14	4.28	4.43	4.59	4.95			
CBN-LRF 2020-020060		6		50	4	26,600	6.21	6.42	6.65	6.89	7.44							
CBN-LRF 2020-020080	8	50		4	28,150	8.28	8.56	8.86	9.19	9.92								
CBN-LRF 2020-020100	10	50		4	29,700	10.34	10.70	11.08	11.49	12.41								
CBN-LRF 2020-050040	RO.5	4	50	4	26,600	4.13	4.26	4.40	4.55	4.88								
CBN-LRF 2020-050060		6	50	4	26,600	6.20	6.40	6.61	6.85	7.37								
CBN-LRF 2020-050080		8	50	4	28,150	8.27	8.54	8.83	9.15	9.85								
CBN-LRF 2020-050100		10	50	4	29,700	10.33	10.68	11.05	11.45	12.34								

- UDC Series
- CBN Series
- Square
- Square
- Long Neck Square
- Radius
- Radius
- Long Neck Radius
- Taper Neck Radius
- Ball / Long Shank Ball
- Ball
- Long Neck Ball
- Taper Neck Ball
- Taper
- Taper
- Spiral V Cutter
- Drill
- EURO Series
- Technical Data

Milling Conditions for CBN-LRF

WORK MATERIAL				HEAT-TREATED STEELS / HARDENED STEELS STAVAX (~52HRC)				HARDENED STEELS SKD11 (~62HRC)				HARDENED STEELS HAP10 / HAP72 (~68HRC)			
Model Number	Outside Diameter (mm)	Corner Radius (mm)	Effective Length (mm)	Spindle Speed (min ⁻¹)	Feed Rate (mm/min)	a _p Axial Depth (mm)	a _e Radial Depth (mm)	Spindle Speed (min ⁻¹)	Feed Rate (mm/min)	a _p Axial Depth (mm)	a _e Radial Depth (mm)	Spindle Speed (min ⁻¹)	Feed Rate (mm/min)	a _p Axial Depth (mm)	a _e Radial Depth (mm)
UDC Series	0.1	R0.02	0.2	30,000	90	0.002	0.01	30,000	60	0.002	0.01	30,000	30	0.002	0.005
			0.3	30,000	90	0.002	0.01	30,000	60	0.002	0.01	30,000	30	0.002	0.005
			0.5	30,000	90	0.002	0.01	30,000	60	0.002	0.01	30,000	30	0.002	0.005
CBN Series	0.1	R0.03	0.2	30,000	90	0.002	0.01	30,000	60	0.002	0.01	30,000	30	0.002	0.005
			0.3	30,000	90	0.002	0.01	30,000	60	0.002	0.01	30,000	30	0.002	0.005
			0.5	30,000	90	0.002	0.01	30,000	60	0.002	0.01	30,000	30	0.002	0.005
Square	0.15	R0.02	0.2	30,000	120	0.003	0.015	30,000	90	0.003	0.015	30,000	60	0.002	0.01
			0.3	30,000	120	0.003	0.015	30,000	90	0.003	0.015	30,000	60	0.002	0.01
			0.5	30,000	120	0.003	0.015	30,000	90	0.003	0.015	30,000	60	0.002	0.01
Long Neck Square	0.15	R0.03	0.2	30,000	120	0.003	0.015	30,000	90	0.003	0.015	30,000	60	0.002	0.01
			0.3	30,000	120	0.003	0.015	30,000	90	0.003	0.015	30,000	60	0.002	0.01
			0.5	30,000	120	0.003	0.015	30,000	90	0.003	0.015	30,000	60	0.002	0.01
Radius	0.2	R0.02	0.5	30,000	140	0.003	0.02	30,000	120	0.003	0.02	30,000	80	0.003	0.01
			0.75	30,000	140	0.003	0.02	30,000	120	0.003	0.02	30,000	80	0.003	0.01
			1	30,000	140	0.003	0.02	30,000	120	0.003	0.02	30,000	80	0.003	0.01
Long Neck Radius	0.2	R0.03	0.5	30,000	140	0.003	0.02	30,000	120	0.003	0.02	30,000	80	0.003	0.01
			0.75	30,000	140	0.003	0.02	30,000	120	0.003	0.02	30,000	80	0.003	0.01
			1	30,000	140	0.003	0.02	30,000	120	0.003	0.02	30,000	80	0.003	0.01
Taper Neck Radius	0.25	R0.05	0.5	30,000	140	0.003	0.02	30,000	120	0.003	0.02	30,000	80	0.003	0.01
			0.75	30,000	140	0.003	0.02	30,000	120	0.003	0.02	30,000	80	0.003	0.01
			1	30,000	140	0.003	0.02	30,000	120	0.003	0.02	30,000	80	0.003	0.01
Ball / Long Shank Ball	0.3	R0.01	0.5	30,000	190	0.004	0.03	30,000	170	0.004	0.03	30,000	140	0.003	0.015
			0.75	30,000	190	0.004	0.03	30,000	170	0.004	0.03	30,000	140	0.003	0.015
			1	30,000	190	0.004	0.03	30,000	170	0.004	0.03	30,000	140	0.003	0.015
Long Neck Ball	0.3	R0.02	0.5	30,000	185	0.003	0.045	30,000	160	0.003	0.045	30,000	120	0.003	0.02
			0.75	30,000	185	0.003	0.045	30,000	160	0.003	0.045	30,000	120	0.003	0.02
			1	30,000	185	0.003	0.045	30,000	160	0.003	0.045	30,000	120	0.003	0.02
Taper Neck Ball	0.3	R0.03	1.5	30,000	185	0.003	0.045	30,000	160	0.003	0.045	30,000	120	0.003	0.02
			2	30,000	130	0.003	0.022	30,000	110	0.003	0.022	30,000	80	0.003	0.01
			0.5	30,000	200	0.004	0.045	30,000	175	0.004	0.045	30,000	150	0.003	0.02
Taper	0.3	R0.05	0.75	30,000	200	0.004	0.045	30,000	175	0.004	0.045	30,000	150	0.003	0.02
			1	30,000	200	0.004	0.045	30,000	175	0.004	0.045	30,000	150	0.003	0.02
			1.5	30,000	200	0.004	0.045	30,000	175	0.004	0.045	30,000	150	0.003	0.02
Spiral V Cutter	0.4	R0.02	2	30,000	140	0.004	0.022	30,000	120	0.004	0.022	30,000	110	0.003	0.01
			0.5	30,000	240	0.005	0.045	30,000	225	0.005	0.045	30,000	210	0.004	0.02
			0.75	30,000	240	0.005	0.045	30,000	225	0.005	0.045	30,000	210	0.004	0.02
Drill	0.4	R0.05	1	30,000	240	0.005	0.045	30,000	225	0.005	0.045	30,000	210	0.004	0.02
			1.5	30,000	240	0.005	0.045	30,000	225	0.005	0.045	30,000	210	0.004	0.02
			2	30,000	170	0.005	0.022	30,000	160	0.005	0.022	30,000	150	0.004	0.01
EURO Series	0.4	R0.02	0.5	30,000	230	0.005	0.065	30,000	200	0.005	0.065	30,000	160	0.004	0.02
			1	30,000	230	0.005	0.065	30,000	200	0.005	0.065	30,000	160	0.004	0.02
			1.5	30,000	230	0.005	0.065	30,000	200	0.005	0.065	30,000	160	0.004	0.02
Technical Data	0.4	R0.03	2	30,000	230	0.005	0.065	30,000	200	0.005	0.065	30,000	160	0.004	0.02
			0.5	30,000	270	0.006	0.065	30,000	230	0.006	0.065	30,000	180	0.004	0.02
			1	30,000	270	0.006	0.065	30,000	230	0.006	0.065	30,000	180	0.004	0.02
	0.4	R0.05	1.5	30,000	270	0.006	0.065	30,000	230	0.006	0.065	30,000	180	0.004	0.02
			0.5	30,000	340	0.01	0.065	30,000	300	0.01	0.065	30,000	220	0.005	0.02
			1	30,000	340	0.01	0.065	30,000	300	0.01	0.065	30,000	220	0.005	0.02
	0.4	R0.05	1.5	30,000	340	0.01	0.065	30,000	300	0.01	0.065	30,000	220	0.005	0.02
			2	30,000	340	0.01	0.065	30,000	300	0.01	0.065	30,000	220	0.005	0.02
			4	30,000	170	0.01	0.032	30,000	150	0.01	0.032	30,000	110	0.005	0.01
	0.4	R0.1	0.5	30,000	520	0.01	0.065	30,000	450	0.01	0.065	30,000	320	0.005	0.02
			1	30,000	520	0.01	0.065	30,000	450	0.01	0.065	30,000	320	0.005	0.02
			1.5	30,000	520	0.01	0.065	30,000	450	0.01	0.065	30,000	320	0.005	0.02

Milling Conditions for CBN-LRF

WORK MATERIAL				HEAT-TREATED STEELS / HARDENED STEELS STAVAX (~52HRC)				HARDENED STEELS SKD11 (~62HRC)				HARDENED STEELS HAP10 / HAP72 (~68HRC)				
Model Number	Outside Diameter (mm)	Corner Radius (mm)	Effective Length (mm)	Spindle Speed (min ⁻¹)	Feed Rate (mm/min)	a _p Axial Depth (mm)	a _e Radial Depth (mm)	Spindle Speed (min ⁻¹)	Feed Rate (mm/min)	a _p Axial Depth (mm)	a _e Radial Depth (mm)	Spindle Speed (min ⁻¹)	Feed Rate (mm/min)	a _p Axial Depth (mm)	a _e Radial Depth (mm)	
2005-001010	0.5	R0.01	1	30,000	280	0.003	0.09	30,000	240	0.003	0.09	30,000	200	0.003	0.03	
2005-002005		R0.02	0.5	30,000	280	0.005	0.09	30,000	240	0.005	0.09	30,000	200	0.005	0.03	
2005-002010			1	30,000	280	0.005	0.09	30,000	240	0.005	0.09	30,000	200	0.005	0.03	
2005-002015			1.5	30,000	280	0.005	0.09	30,000	240	0.005	0.09	30,000	200	0.005	0.03	
2005-002020			2	30,000	280	0.005	0.09	30,000	240	0.005	0.09	30,000	200	0.005	0.03	
2005-003005			R0.03	0.5	30,000	330	0.006	0.09	30,000	280	0.006	0.09	30,000	230	0.005	0.03
2005-003010		1		30,000	330	0.006	0.09	30,000	280	0.006	0.09	30,000	230	0.005	0.03	
2005-003015		1.5		30,000	330	0.006	0.09	30,000	280	0.006	0.09	30,000	230	0.005	0.03	
2005-003020		R0.05	2	30,000	330	0.006	0.09	30,000	280	0.006	0.09	30,000	230	0.005	0.03	
2005-005005			0.5	30,000	440	0.01	0.09	30,000	380	0.01	0.09	30,000	280	0.01	0.03	
2005-005010			R0.05	1	30,000	440	0.01	0.09	30,000	380	0.01	0.09	30,000	280	0.01	0.03
2005-005015				1.5	30,000	440	0.01	0.09	30,000	380	0.01	0.09	30,000	280	0.01	0.03
2005-005020				2	30,000	440	0.01	0.09	30,000	380	0.01	0.09	30,000	280	0.01	0.03
2005-010005			R0.1	0.5	30,000	700	0.02	0.09	30,000	600	0.02	0.09	30,000	410	0.01	0.03
2005-010010		1		30,000	700	0.02	0.09	30,000	600	0.02	0.09	30,000	410	0.01	0.03	
2005-010015		1.5		30,000	700	0.02	0.09	30,000	600	0.02	0.09	30,000	410	0.01	0.03	
2005-010020		2		30,000	700	0.02	0.09	30,000	600	0.02	0.09	30,000	410	0.01	0.03	
2006-002005		0.6	R0.02	0.5	30,000	320	0.005	0.11	30,000	270	0.005	0.11	30,000	240	0.005	0.035
2006-002010				1	30,000	320	0.005	0.11	30,000	270	0.005	0.11	30,000	240	0.005	0.035
2006-002015				1.5	30,000	320	0.005	0.11	30,000	270	0.005	0.11	30,000	240	0.005	0.035
2006-005005	R0.05		0.5	30,000	500	0.01	0.11	30,000	430	0.01	0.11	30,000	340	0.01	0.035	
2006-005010			1	30,000	500	0.01	0.11	30,000	430	0.01	0.11	30,000	340	0.01	0.035	
2006-005015			1.5	30,000	500	0.01	0.11	30,000	430	0.01	0.11	30,000	340	0.01	0.035	
2006-005030			3	30,000	500	0.01	0.11	30,000	430	0.01	0.11	30,000	340	0.01	0.035	
2006-010005	R0.1		0.5	30,000	800	0.02	0.11	30,000	675	0.02	0.11	30,000	492	0.01	0.035	
2006-010010			1	30,000	800	0.02	0.11	30,000	675	0.02	0.11	30,000	492	0.01	0.035	
2006-010015			1.5	30,000	800	0.02	0.11	30,000	675	0.02	0.11	30,000	492	0.01	0.035	
2008-002010	0.8		R0.02	1	30,000	410	0.005	0.16	30,000	350	0.005	0.16	30,000	320	0.005	0.04
2008-002015				1.5	30,000	410	0.005	0.16	30,000	350	0.005	0.16	30,000	320	0.005	0.04
2008-002020		2		30,000	410	0.005	0.16	30,000	350	0.005	0.16	30,000	320	0.005	0.04	
2008-002050		5		30,000	290	0.005	0.08	30,000	250	0.005	0.08	30,000	220	0.005	0.02	
2008-005010		R0.05	1	30,000	600	0.01	0.16	30,000	510	0.01	0.16	30,000	450	0.01	0.04	
2008-005015			1.5	30,000	600	0.01	0.16	30,000	510	0.01	0.16	30,000	450	0.01	0.04	
2008-005020			2	30,000	600	0.01	0.16	30,000	510	0.01	0.16	30,000	450	0.01	0.04	
2008-005050			5	30,000	420	0.01	0.08	30,000	360	0.01	0.08	30,000	320	0.01	0.02	
2008-010010		R0.1	1	30,000	920	0.02	0.16	30,000	790	0.02	0.16	30,000	560	0.01	0.04	
2008-010015			1.5	30,000	920	0.02	0.16	30,000	790	0.02	0.16	30,000	560	0.01	0.04	
2008-010020			2	30,000	920	0.02	0.16	30,000	790	0.02	0.16	30,000	560	0.01	0.04	
2008-010050			5	30,000	640	0.02	0.08	30,000	550	0.02	0.08	30,000	390	0.01	0.02	

UDC Series

CBN Series

Square

Square

Radius

Radius

Radius

Taper Neck Radius

Ball / Long Shank Ball

Ball

Ball

Taper Neck Ball

Taper

Taper

Spiral V Cutter

Drill

EURO Series

Technical Data

Milling Conditions for CBN-LRF

WORK MATERIAL				HEAT-TREATED STEELS / HARDENED STEELS STAVAX (~52HRC)				HARDENED STEELS SKD11 (~62HRC)				HARDENED STEELS HAP10 / HAP72 (~68HRC)				
Model Number	Outside Diameter (mm)	Corner Radius (mm)	Effective Length (mm)	Spindle Speed (min ⁻¹)	Feed Rate (mm/min)	a _p Axial Depth (mm)	a _e Radial Depth (mm)	Spindle Speed (min ⁻¹)	Feed Rate (mm/min)	a _p Axial Depth (mm)	a _e Radial Depth (mm)	Spindle Speed (min ⁻¹)	Feed Rate (mm/min)	a _p Axial Depth (mm)	a _e Radial Depth (mm)	
2010-002010	1	R0.02	1	30,000	500	0.005	0.2	30,000	430	0.005	0.2	30,000	400	0.005	0.05	
2010-002020			2	30,000	500	0.005	0.2	30,000	430	0.005	0.2	30,000	400	0.005	0.05	
2010-002030			3	30,000	500	0.005	0.2	30,000	430	0.005	0.2	30,000	400	0.005	0.05	
2010-002050			5	30,000	500	0.005	0.2	30,000	430	0.005	0.2	30,000	400	0.005	0.05	
2010-005010		R0.05	1	30,000	700	0.01	0.2	30,000	600	0.01	0.2	30,000	500	0.01	0.05	
2010-005020			2	30,000	700	0.01	0.2	30,000	600	0.01	0.2	30,000	500	0.01	0.05	
2010-005030			3	30,000	700	0.01	0.2	30,000	600	0.01	0.2	30,000	500	0.01	0.05	
2010-005050			5	30,000	700	0.01	0.2	30,000	600	0.01	0.2	30,000	500	0.01	0.05	
2010-010010		R0.1	1	30,000	1,000	0.02	0.2	30,000	850	0.02	0.2	30,000	600	0.01	0.05	
2010-010020			2	30,000	1,000	0.02	0.2	30,000	850	0.02	0.2	30,000	600	0.01	0.05	
2010-010030			3	30,000	1,000	0.02	0.2	30,000	850	0.02	0.2	30,000	600	0.01	0.05	
2010-010050			5	30,000	1,000	0.02	0.2	30,000	850	0.02	0.2	30,000	600	0.01	0.05	
2010-020010		R0.2	1	30,000	1,600	0.04	0.2	30,000	1,350	0.04	0.2	30,000	850	0.01	0.05	
2010-020020			2	30,000	1,600	0.04	0.2	30,000	1,350	0.04	0.2	30,000	850	0.01	0.05	
2015-002030		1.5	R0.02	3	27,000	800	0.005	0.3	27,000	680	0.005	0.3	20,000	470	0.005	0.23
2015-002040				4	27,000	800	0.005	0.3	27,000	680	0.005	0.3	20,000	470	0.005	0.23
2015-002060	6			27,000	800	0.005	0.3	27,000	680	0.005	0.3	20,000	470	0.005	0.23	
2015-005030	R0.05		3	27,000	1,200	0.01	0.3	27,000	1,000	0.01	0.3	20,000	520	0.01	0.23	
2015-005040			4	27,000	1,200	0.01	0.3	27,000	1,000	0.01	0.3	20,000	520	0.01	0.23	
2015-005060			6	27,000	1,200	0.01	0.3	27,000	1,000	0.01	0.3	20,000	520	0.01	0.23	
2015-010030	R0.1	3	27,000	1,500	0.02	0.3	27,000	1,300	0.02	0.3	20,000	600	0.01	0.23		
2015-010040		4	27,000	1,500	0.02	0.3	27,000	1,300	0.02	0.3	20,000	600	0.01	0.23		
2015-010060		6	27,000	1,500	0.02	0.3	27,000	1,300	0.02	0.3	20,000	600	0.01	0.23		
2015-030045	R0.3	4.5	27,000	1,800	0.06	0.3	27,000	1,500	0.06	0.3	25,000	930	0.01	0.23		
2020-002040	R0.02	4	24,000	1,000	0.005	0.4	24,000	850	0.005	0.4	16,000	530	0.005	0.4		
2020-002060		6	24,000	1,000	0.005	0.4	24,000	850	0.005	0.4	16,000	530	0.005	0.4		
2020-002080		8	24,000	1,000	0.005	0.4	24,000	850	0.005	0.4	16,000	530	0.005	0.4		
2020-002100		10	24,000	1,000	0.005	0.4	24,000	850	0.005	0.4	16,000	530	0.005	0.4		
2020-003030	R0.03	3	24,000	1,000	0.006	0.4	24,000	850	0.006	0.4	16,000	550	0.005	0.4		
2020-005040	R0.05	4	24,000	1,500	0.01	0.4	24,000	1,300	0.01	0.4	16,500	600	0.01	0.4		
2020-005060		6	24,000	1,500	0.01	0.4	24,000	1,300	0.01	0.4	16,500	600	0.01	0.4		
2020-005080		8	24,000	1,500	0.01	0.4	24,000	1,300	0.01	0.4	16,500	600	0.01	0.35		
2020-005100		10	24,000	1,500	0.01	0.4	24,000	1,300	0.01	0.4	16,500	600	0.01	0.3		
2020-010040	R0.1	4	24,000	2,000	0.02	0.4	24,000	1,700	0.02	0.4	17,000	700	0.01	0.4		
2020-010060		6	24,000	2,000	0.02	0.4	24,000	1,700	0.02	0.4	17,000	700	0.01	0.4		
2020-010080		8	24,000	2,000	0.02	0.4	24,000	1,700	0.02	0.4	17,000	700	0.01	0.35		
2020-010100		10	24,000	2,000	0.02	0.4	24,000	1,700	0.02	0.4	17,000	700	0.01	0.3		
2020-020040	R0.2	4	24,000	2,000	0.04	0.4	24,000	1,700	0.04	0.4	17,700	770	0.01	0.4		
2020-020060		6	24,000	2,000	0.04	0.4	24,000	1,700	0.04	0.4	17,700	770	0.01	0.4		
2020-020080		8	24,000	2,000	0.03	0.4	24,000	1,700	0.03	0.4	17,700	770	0.01	0.35		
2020-020100		10	24,000	2,000	0.025	0.4	24,000	1,700	0.025	0.4	17,700	770	0.01	0.3		
2020-050040	R0.5	4	24,000	2,000	0.1	0.4	24,000	1,700	0.1	0.4	20,000	1,000	0.01	0.4		
2020-050060		6	24,000	2,000	0.1	0.4	24,000	1,700	0.1	0.4	20,000	1,000	0.01	0.4		
2020-050080		8	24,000	2,000	0.075	0.4	24,000	1,700	0.075	0.4	20,000	1,000	0.01	0.35		
2020-050100		10	24,000	2,000	0.05	0.4	24,000	1,700	0.05	0.4	20,000	1,000	0.01	0.3		

Note:

- Decrease both spindle speed and feed rate proportionally when the milling parameters exceed the machine's maximum spindle speed.
- Recommend oil mist to avoid tool damage.

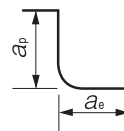

a_p : Axial Depth (mm)
a_e : Radial Depth (mm)

* Refer to page 588 for tool geometry.

Milling example of square pocket

CBN-LRF $\phi 2 \times CR0.02 \times$ Effective Length 4

HAP10 (65HRC)

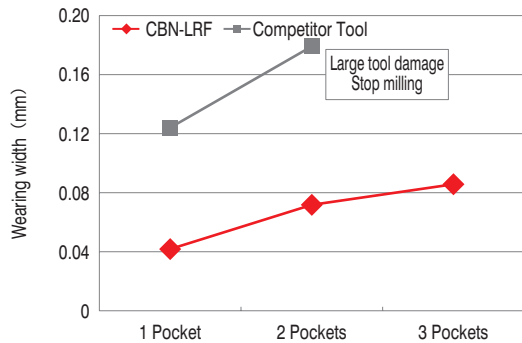
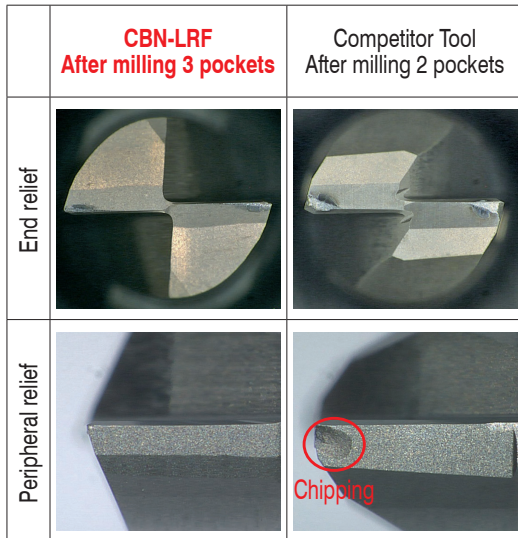

Less tool damage on 65HRC high speed steel.

Pocket Size : $15 \times 15 \times 0.3$ mm
Coolant : Oil Mist

Tool	Spindle Speed (min ⁻¹)	Feed Rate (mm/min)	a_p Axial Depth (mm)	a_e Radial Depth (mm)	Cycle Time
CBN-LRF 2020-002040	16,000	530	0.005	0.4	59 min / pocket

Milling example of LED mold

CBN-LRF $\phi 0.4 \times CR0.02 \times$ Effective Length1

ELMAX (62 ~ 64HRC)

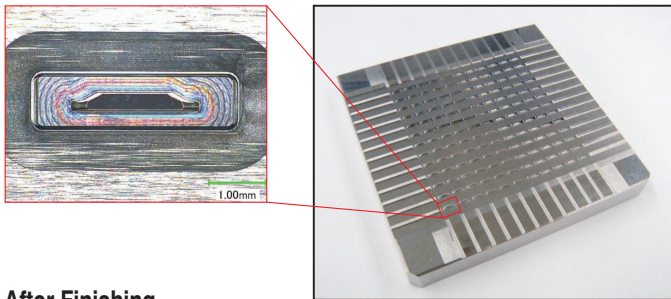

Work Size : $80 \times 80 \times 10$ mm
Coolant : Oil Mist

After Finishing

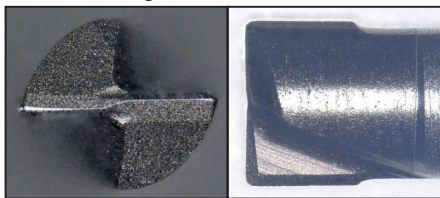

Less tool damage after 10 hours of milling!

Tool	Milling Process	Spindle Speed (min ⁻¹)	Feed Rate (mm/min)	a_p Axial Depth (mm)	a_e Radial Depth (mm)	Cycle Time
CBN-LRF 2004-002010	Finishing	38,000	600	0.01	0.01	10 h

UDC Series

CBN Series

Square

Long Neck Square

Radius

Long Neck Radius

Taper Neck Radius

Ball / Long Shank Ball

Long Neck Ball

Taper Neck Ball

Taper

Spiral V Cutter

Drill

EURO Series

Technical Data



Size $\phi 0.1 \sim \phi 12$

CSS

Super
MG

UT
COAT

30°

40°

Flatland

Shank Dia
0/-0.005

*1 Helix angle 30°: $\phi D < 0.6, 1 \leq \phi D$ (length of cut 2.5D~3D)
 *2 Helix angle 40°: $0.6 \leq \phi D < 1, 1 \leq \phi D$ (length of cut 1D ~ 2D)

Material Applications (☆ Highly Recommended ○ Recommended ○ Suggested)

Work Material															
Carbon Steels S45C S55C	Alloy Steels SK / SCM SUS	Prehardened Steels NAK HPM	Hardened Steels			Cast Iron	Aluminum Alloys	Graphite	Copper	Plastics	Glass Filled Plastics	Titanium Alloys	Heat Resistant Alloys	Cemented Carbide	Hard Brittle (Non-Metallic) Materials
			~55HRC	~60HRC	~70HRC										
○	○	○	○			○	○		○			○	○		

Features

The new flute design offers excellent chip evacuation.
 Resistance to breakage and wear has been improved by combining a special carbide grade with a new version of UT COAT.

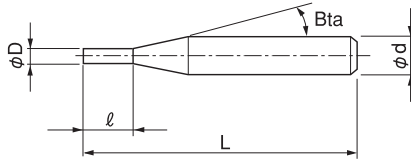

The shank taper angle shown is not an exact value and to avoid contact with the work piece, we recommend the user controls the precise value of this angle. Shank taper angle should not make contact with the work piece.

Total 112 models

Unit (mm)

Model Number	Outside Diameter ϕD	Length of Cut ℓ	Shank Taper Angle Bta	Overall Length L	Shank Diameter ϕd	Price ¥
CSS 2001-0010	0.1	0.1	16°	45	4	7,800
CSS 2001-0015		0.15		45	4	7,800
CSS 2001-0020		0.2		45	4	7,800
CSS 2001-0025		0.25		45	4	7,800
CSS 2001-0030		0.3		45	4	7,800
CSS 2002-0020	0.2	0.2	16°	45	4	4,680
CSS 2002-0030		0.3		45	4	4,680
CSS 2002-0040-3		0.4		38	3	4,680
CSS 2002-0040-4		0.4		45	4	4,680
CSS 2002-0050		0.5		45	4	4,680
CSS 2002-0060	0.3	0.6	16°	45	4	4,680
CSS 2003-0030		0.3		45	4	4,080
CSS 2003-0045		0.45		45	4	4,080
CSS 2003-0060-3		0.6		38	3	4,080
CSS 2003-0060-4		0.6		45	4	4,080
CSS 2003-0075	0.3	0.75	16°	45	4	4,080
CSS 2003-0090		0.9		45	4	4,080

Unit (mm)

Model Number	Outside Diameter ϕD	Length of Cut ℓ	Shank Taper Angle Bta	Overall Length L	Shank Diameter ϕd	Price ¥
CSS 2004-0040	0.4	0.4	16°	45	4	4,560
CSS 2004-0060		0.6		45	4	4,560
CSS 2004-0080-3		0.8		38	3	4,560
CSS 2004-0080-4				45	4	4,560
CSS 2004-0100		1		45	4	4,560
CSS 2004-0120		1.2		45	4	4,560
CSS 2005-0050	0.5	0.5	16°	45	4	2,280
CSS 2005-0075		0.75		45	4	2,280
CSS 2005-0080		0.8		38	3	2,280
CSS 2005-0100		1		45	4	2,280
CSS 2005-0125		1.25		45	4	2,280
CSS 2005-0150	1.5	45	4	2,280		
CSS 2006-0060	0.6	0.6	16°	45	4	3,480
CSS 2006-0090		0.9		45	4	3,480
CSS 2006-0100		1		38	3	3,480
CSS 2006-0120		1.2		45	4	3,480
CSS 2006-0150		1.5		45	4	3,480
CSS 2006-0180		1.8		45	4	3,480
CSS 2007-0070	0.7	0.7	16°	45	4	3,840
CSS 2007-0100		1		38	3	3,840
CSS 2007-0140		1.4		45	4	3,840
CSS 2007-0175		1.75		45	4	3,840
CSS 2007-0210		2.1		45	4	3,840
CSS 2008-0080	0.8	0.8	16°	45	4	2,280
CSS 2008-0120-3		1.2		38	3	2,280
CSS 2008-0120-4				45	4	2,280
CSS 2008-0160		1.6		45	4	2,280
CSS 2008-0200		2		45	4	2,280
CSS 2008-0240	2.4	45	4	2,280		
CSS 2009-0090	0.9	0.9	16°	45	4	3,840
CSS 2009-0120		1.2		38	3	3,840
CSS 2009-0180		1.8		45	4	3,840
CSS 2009-0225		2.25		45	4	3,840
CSS 2009-0270		2.7		45	4	3,840
CSS 2010-0100	1	1	16°	45	4	2,040
CSS 2010-0150		1.5		45	4	2,040
CSS 2010-0200		2		45	4	2,040
CSS 2010-0250		2.5		45	4	2,040
CSS 2010-0300		3		45	4	2,040
CSS 2015-0150	1.5	1.5	16°	45	4	2,040
CSS 2015-0225		2.25		45	4	2,040
CSS 2015-0300		3		45	4	2,040
CSS 2015-0375		3.75		45	4	2,040
CSS 2015-0450		4.5		45	4	2,040
CSS 2020-0200	2	2	16°	45	4	2,040
CSS 2020-0300		3		45	4	2,040
CSS 2020-0400		4		45	4	2,040
CSS 2020-0500		5		45	4	2,040
CSS 2020-0600		6		45	4	2,040

UDC
SeriesCBN
SeriesSquare
Long Neck
Square

Radius

Radius
Long Neck
RadiusTaper Neck
RadiusBall / Long
Shank BallBall
Long Neck
BallTaper Neck
BallTaper
TaperSpiral
V Cutter

Drill

EURO Series

Technical Data

Unit (mm)

Model Number	Outside Diameter ϕD	Length of Cut l	Shank Taper Angle Bta	Overall Length L	Shank Diameter ϕd	Price ¥
CSS 2025-0250	2.5	2.5	16°	50	4	2,040
CSS 2025-0375		3.75		50	4	2,040
CSS 2025-0500		5		50	4	2,040
CSS 2025-0625		6.25		50	4	2,040
CSS 2025-0750		7.5		50	4	2,040
CSS 2030-0300	3	3	16°	50	6	2,640
CSS 2030-0450		4.5		50	6	2,640
CSS 2030-0600		6		50	6	2,640
CSS 2030-0750		7.5		50	6	2,640
CSS 2040-0400	4	4	16°	50	6	2,880
CSS 2040-0600		6		50	6	2,880
CSS 2040-0800		8		50	6	2,880
CSS 2040-1000		10		50	6	2,880
CSS 2040-1200		12		50	6	2,880
CSS 2050-0500	5	5	16°	50	6	3,120
CSS 2050-0750		7.5		50	6	3,120
CSS 2050-1000		10		50	6	3,120
CSS 2050-1250		12.5		60	6	3,120
CSS 2050-1500		15		60	6	3,120
CSS 2060-0600	6	6	—	50	6	3,360
CSS 2060-0900		9		50	6	3,360
CSS 2060-1200		12		50	6	3,360
CSS 2060-1500		15		60	6	3,360
CSS 2060-1800		18		60	6	3,360
CSS 2070-1750	7	17.5	16°	70	8	8,700
CSS 2070-2100		21		80	8	8,700
CSS 2080-0800	8	8	—	70	8	6,320
CSS 2080-1200		12		70	8	6,320
CSS 2080-1600		16		70	8	6,320
CSS 2080-2000		20		70	8	6,320
CSS 2080-2400		24		80	8	6,320
CSS 2090-2250	9	22.5	16°	80	10	12,420
CSS 2090-2700		27		80	10	12,420
CSS 2100-1000	10	10	—	70	10	7,580
CSS 2100-1500		15		70	10	7,580
CSS 2100-2000		20		70	10	7,580
CSS 2100-2500		25		80	10	7,580
CSS 2100-3000		30		80	10	7,580
CSS 2110-2750	11	27.5	16°	80	12	17,160
CSS 2110-3300		33		80	12	17,160
CSS 2120-1200	12	12	—	80	12	11,170
CSS 2120-1800		18		80	12	11,170
CSS 2120-2400		24		80	12	11,170
CSS 2120-3000		30		80	12	11,170
CSS 2120-3600		36		90	12	11,170

- UDC Series
- CBN Series
- Square
- Long Neck Square
- Radius
- Long Neck Radius
- Taper Neck Radius
- Ball / Long Shank Ball
- Long Neck Ball
- Taper Neck Ball
- Taper
- Spiral V Cutter
- Drill
- EURO Series
- Technical Data

Milling Conditions for CSS

Slotting

◆ 1D flute length type L/D=1

WORK MATERIAL			CARBON STEELS S45C / S50C Annealed Materials (~225HB)			ALLOY STEELS SK / SCM Annealed Materials (225~325HB)			STAINLESS STEELS SUS304 * Use water soluble or oil coolant.		
Model Number	Outside Diameter (mm)	Length of Cut (mm)	Spindle Speed (min ⁻¹)	Feed Rate (mm/min)	Milling Amount (mm)	Spindle Speed (min ⁻¹)	Feed Rate (mm/min)	Milling Amount (mm)	Spindle Speed (min ⁻¹)	Feed Rate (mm/min)	Milling Amount (mm)
				Slotting	a_p		Slotting	a_p		Slotting	a_p
2001-0010	0.1	0.1	30,000	30	0.01	30,000	30	0.01	30,000	30	0.01
2002-0020	0.2	0.2	30,000	85	0.02	30,000	85	0.02	30,000	60	0.02
2003-0030	0.3	0.3	30,000	110	0.03	30,000	110	0.03	30,000	110	0.03
2004-0040	0.4	0.4	30,000	120	0.04	30,000	120	0.04	30,000	120	0.04
2005-0050	0.5	0.5	27,000	120	0.05	24,000	105	0.05	24,000	120	0.05
2006-0060	0.6	0.6	24,000	120	0.09	20,000	90	0.09	20,000	120	0.09
2007-0070	0.7	0.7	22,500	115	0.105	17,800	90	0.105	17,800	120	0.105
2008-0080	0.8	0.8	21,000	110	0.12	16,700	90	0.12	16,700	120	0.12
2009-0090	0.9	0.9	19,500	105	0.135	15,600	85	0.135	15,600	120	0.135
2010-0100	1	1	18,000	100	1	14,500	75	1	14,500	125	1
2015-0150	1.5	1.5	16,000	275	1.5	13,000	200	1.5	13,000	135	1.5
2020-0200	2	2	12,000	275	2	10,000	200	2	10,000	135	2
2025-0250	2.5	2.5	10,200	375	2.5	8,400	260	2.5	8,400	140	2.5
2030-0300	3	3	8,500	475	3	6,800	325	3	6,800	150	3
2040-0400	4	4	7,200	475	4	5,700	325	4	5,700	175	4
2050-0500	5	5	6,000	500	5	4,800	350	5	4,800	200	5
2060-0600	6	6	5,000	500	6	4,000	350	6	4,000	200	6
2080-0800	8	8	3,500	475	8	2,700	350	8	2,400	150	8
2100-1000	10	10	2,300	450	10	1,900	325	10	1,400	100	10
2120-1200	12	12	1,850	425	12	1,550	300	12	1,250	90	12

WORK MATERIAL			PREHARDENED STEELS HPM / NAK (30~45HRC)			HARDENED STEELS SKD / SKT / STAVAX (45~55HRC)		
Model Number	Outside Diameter (mm)	Length of Cut (mm)	Spindle Speed (min ⁻¹)	Feed Rate (mm/min)	Milling Amount (mm)	Spindle Speed (min ⁻¹)	Feed Rate (mm/min)	Milling Amount (mm)
				Slotting	a_p		Slotting	a_p
2001-0010	0.1	0.1	30,000	15	0.01	24,000	10	0.004
2002-0020	0.2	0.2	30,000	30	0.02	23,000	25	0.008
2003-0030	0.3	0.3	30,000	55	0.03	20,000	25	0.012
2004-0040	0.4	0.4	30,000	60	0.04	16,800	25	0.016
2005-0050	0.5	0.5	24,000	60	0.05	14,400	30	0.025
2006-0060	0.6	0.6	20,000	60	0.09	12,000	35	0.03
2007-0070	0.7	0.7	17,800	60	0.105	10,000	35	0.035
2008-0080	0.8	0.8	16,700	60	0.12	8,500	35	0.04
2009-0090	0.9	0.9	15,600	60	0.135	7,300	35	0.045
2010-0100	1	1	14,500	60	1	6,550	35	0.2
2015-0150	1.5	1.5	12,000	160	1.5	4,400	35	0.3
2020-0200	2	2	9,000	160	2	3,300	35	0.4
2025-0250	2.5	2.5	7,900	210	2.5	2,750	35	0.5
2030-0300	3	3	6,800	260	3	2,200	35	0.6
2040-0400	4	4	5,100	260	4	1,650	40	0.8
2050-0500	5	5	4,050	260	5	1,300	40	1
2060-0600	6	6	3,300	260	6	1,100	40	1.2
2080-0800	8	8	2,300	235	8	800	40	1.6
2100-1000	10	10	1,500	225	10	690	40	2
2120-1200	12	12	1,200	210	12	550	40	2.4

UDC Series

CBN Series

Square

Long Neck Square

Radius

Long Neck Radius

Taper Neck Radius

Ball / Long Shank Ball

Long Neck Ball

Taper Neck Ball

Taper

Spiral V Cutter

Drill

EURO Series

Technical Data

Milling Conditions for CSS

◆ 1.5D flute length type $1 < L/D \leq 1.5$

WORK MATERIAL			CARBON STEELS S45C / S50C Annealed Materials (~225HB)			ALLOY STEELS SK / SCM Annealed Materials (225~325HB)			STAINLESS STEELS SUS304 *Use water soluble or oil coolant.		
Model Number	Outside Diameter (mm)	Length of Cut (mm)	Spindle Speed (min ⁻¹)	Feed Rate (mm/min)	Milling Amount (mm)	Spindle Speed (min ⁻¹)	Feed Rate (mm/min)	Milling Amount (mm)	Spindle Speed (min ⁻¹)	Feed Rate (mm/min)	Milling Amount (mm)
				Slotting	a _p		Slotting	a _p		Slotting	a _p
2001-0015	0.1	0.15	30,000	30	0.01	30,000	30	0.01	30,000	30	0.01
2002-0030	0.2	0.3	30,000	85	0.02	30,000	85	0.02	30,000	60	0.02
2003-0045	0.3	0.45	30,000	110	0.03	30,000	110	0.03	30,000	110	0.03
2004-0060	0.4	0.6	30,000	120	0.04	30,000	120	0.04	30,000	120	0.04
2005-0075	0.5	0.75	27,000	120	0.05	24,000	105	0.05	24,000	120	0.05
2006-0090	0.6	0.9	24,000	120	0.09	20,000	90	0.09	20,000	120	0.09
2007-0100	0.7	1	22,500	115	0.105	17,800	90	0.105	17,800	120	0.105
2008-0120	0.8	1.2	21,000	110	0.12	16,700	90	0.12	16,700	120	0.12
2009-0120	0.9	1.2	19,500	105	0.135	15,600	85	0.135	15,600	120	0.135
2010-0150	1	1.5	18,000	100	1	14,500	75	1	14,500	125	1
2015-0225	1.5	2.25	16,000	275	1.5	13,000	200	1.5	13,000	135	1.5
2020-0300	2	3	12,000	275	2	10,000	200	2	10,000	135	2
2025-0375	2.5	3.75	10,200	375	2.5	8,400	260	2.5	8,400	140	2.5
2030-0450	3	4.5	8,500	475	3	6,800	325	3	6,800	150	3
2040-0600	4	6	7,200	475	4	5,700	325	4	5,700	175	4
2050-0750	5	7.5	6,000	500	5	4,800	350	5	4,800	200	5
2060-0900	6	9	5,000	500	6	4,000	350	6	4,000	200	6
2080-1200	8	12	3,500	475	8	2,700	350	8	2,400	150	8
2100-1500	10	15	2,300	450	10	1,900	325	10	1,400	100	10
2120-1800	12	18	1,850	425	12	1,550	300	12	1,250	90	12

WORK MATERIAL			PREHARDENED STEELS HPM / NAK (30~45HRC)			HARDENED STEELS SKD / SKT / STAVAX (45~55HRC)		
Model Number	Outside Diameter (mm)	Length of Cut (mm)	Spindle Speed (min ⁻¹)	Feed Rate (mm/min)	Milling Amount (mm)	Spindle Speed (min ⁻¹)	Feed Rate (mm/min)	Milling Amount (mm)
				Slotting	a _p		Slotting	a _p
2001-0015	0.1	0.15	30,000	15	0.01	24,000	10	0.004
2002-0030	0.2	0.3	30,000	30	0.02	23,000	25	0.008
2003-0045	0.3	0.45	30,000	55	0.03	20,000	25	0.012
2004-0060	0.4	0.6	30,000	60	0.04	16,800	25	0.016
2005-0075	0.5	0.75	24,000	60	0.05	14,400	30	0.025
2006-0090	0.6	0.9	20,000	60	0.09	12,000	35	0.03
2007-0100	0.7	1	17,800	60	0.105	10,000	35	0.035
2008-0120	0.8	1.2	16,700	60	0.12	8,500	35	0.04
2009-0120	0.9	1.2	15,600	60	0.135	7,300	35	0.045
2010-0150	1	1.5	14,500	60	1	6,550	35	0.2
2015-0225	1.5	2.25	12,000	160	1.5	4,400	35	0.3
2020-0300	2	3	9,000	160	2	3,300	35	0.4
2025-0375	2.5	3.75	7,900	210	2.5	2,750	35	0.5
2030-0450	3	4.5	6,800	260	3	2,200	35	0.6
2040-0600	4	6	5,100	260	4	1,650	40	0.8
2050-0750	5	7.5	4,050	260	5	1,300	40	1
2060-0900	6	9	3,300	260	6	1,100	40	1.2
2080-1200	8	12	2,300	235	8	800	40	1.6
2100-1500	10	15	1,500	225	10	690	40	2
2120-1800	12	18	1,200	210	12	550	40	2.4

- UDC Series
- CBN Series
- Square
- Long Neck Square
- Radius
- Long Neck Radius
- Taper Neck Radius
- Ball / Long Shark Ball
- Long Neck Ball
- Taper Neck Ball
- Taper
- Spiral V Cutter
- Drill
- EURO Series
- Technical Data

Milling Conditions for CSS

◆ 2D flute length type $1.5 < L/D \leq 2$

WORK MATERIAL			CARBON STEELS S45C / S50C Annealed Materials (~225HB)			ALLOY STEELS SK / SCM Annealed Materials (225~325HB)			STAINLESS STEELS SUS304 * Use water soluble or oil coolant.		
Model Number	Outside Diameter (mm)	Length of Cut (mm)	Spindle Speed (min ⁻¹)	Feed Rate (mm/min)	Milling Amount (mm)	Spindle Speed (min ⁻¹)	Feed Rate (mm/min)	Milling Amount (mm)	Spindle Speed (min ⁻¹)	Feed Rate (mm/min)	Milling Amount (mm)
				Slotting	a_p		Slotting	a_p		Slotting	a_p
2001-0020	0.1	0.2	30,000	30	0.01	30,000	30	0.01	30,000	30	0.01
2002-0040	0.2	0.4	30,000	85	0.02	30,000	85	0.02	30,000	60	0.02
2003-0060	0.3	0.6	30,000	110	0.03	30,000	110	0.03	30,000	110	0.03
2004-0080	0.4	0.8	30,000	120	0.04	30,000	120	0.04	30,000	120	0.04
2005-0080	0.5	0.8	27,000	120	0.05	24,000	105	0.05	24,000	120	0.05
2005-0100	0.5	1	27,000	120	0.05	24,000	105	0.05	24,000	120	0.05
2006-0100	0.6	1	24,000	120	0.09	20,000	90	0.09	20,000	120	0.09
2006-0120	0.6	1.2	24,000	120	0.09	20,000	90	0.09	20,000	120	0.09
2007-0140	0.7	1.4	22,500	115	0.105	17,800	90	0.105	17,800	120	0.105
2008-0160	0.8	1.6	21,000	110	0.12	16,700	90	0.12	16,700	120	0.12
2009-0180	0.9	1.8	19,500	105	0.135	15,600	85	0.135	15,600	120	0.135
2010-0200	1	2	18,000	100	0.8	14,500	75	0.8	14,500	125	0.8
2015-0300	1.5	3	16,000	275	1.2	13,000	200	1.2	13,000	135	1.2
2020-0400	2	4	12,000	275	1.6	10,000	200	1.6	10,000	135	1.6
2025-0500	2.5	5	10,200	375	2	8,400	260	2	8,400	140	2
2030-0600	3	6	8,500	475	2.4	6,800	325	2.4	6,800	150	2.4
2040-0800	4	8	7,200	475	3.2	5,700	325	3.2	5,700	175	3.2
2050-1000	5	10	6,000	500	4	4,800	350	4	4,800	200	4
2060-1200	6	12	5,000	500	4.8	4,000	350	4.8	4,000	200	4.8
2080-1600	8	16	3,500	475	6.4	2,700	350	6.4	2,400	150	6.4
2100-2000	10	20	2,300	450	8	1,900	325	8	1,400	100	8
2120-2400	12	24	1,850	425	9.6	1,550	300	9.6	1,250	90	9.6

WORK MATERIAL			PREHARDENED STEELS HPM / NAK (30~45HRC)			HARDENED STEELS SKD / SKT / STAVAX (45~55HRC)		
Model Number	Outside Diameter (mm)	Length of Cut (mm)	Spindle Speed (min ⁻¹)	Feed Rate (mm/min)	Milling Amount (mm)	Spindle Speed (min ⁻¹)	Feed Rate (mm/min)	Milling Amount (mm)
				Slotting	a_p		Slotting	a_p
2001-0020	0.1	0.2	30,000	15	0.01	24,000	10	0.003
2002-0040	0.2	0.4	30,000	30	0.02	23,000	25	0.008
2003-0060	0.3	0.6	30,000	55	0.03	20,000	25	0.012
2004-0080	0.4	0.8	30,000	60	0.04	16,800	25	0.016
2005-0080	0.5	0.8	24,000	60	0.05	14,400	30	0.025
2005-0100	0.5	1	24,000	60	0.05	14,400	30	0.025
2006-0100	0.6	1	20,000	60	0.09	12,000	35	0.03
2006-0120	0.6	1.2	20,000	60	0.09	12,000	35	0.03
2007-0140	0.7	1.4	17,800	60	0.105	10,000	35	0.035
2008-0160	0.8	1.6	16,700	60	0.12	8,500	35	0.04
2009-0180	0.9	1.8	15,600	60	0.135	7,300	35	0.045
2010-0200	1	2	14,500	60	0.8	6,550	35	0.15
2015-0300	1.5	3	12,000	160	1.2	4,400	35	0.225
2020-0400	2	4	9,000	160	1.6	3,300	35	0.3
2025-0500	2.5	5	7,900	210	2	2,750	35	0.37
2030-0600	3	6	6,800	260	2.4	2,200	35	0.45
2040-0800	4	8	5,100	260	3.2	1,650	40	0.6
2050-1000	5	10	4,050	260	4	1,300	40	0.75
2060-1200	6	12	3,300	260	4.8	1,100	40	0.9
2080-1600	8	16	2,300	235	3.2	800	40	1.2
2100-2000	10	20	1,500	225	4	690	40	1.5
2120-2400	12	24	1,200	210	4.8	550	40	1.8

UDC Series

CBN Series

Square

Square

Long Neck Square

Radius

Radius

Long Neck Radius

Taper Neck Radius

Taper Neck Radius

Ball / Long Shank Ball

Ball

Long Neck Ball

Taper Neck Ball

Taper Neck Ball

Taper

Taper

Spiral V Cutter

Spiral V Cutter

Drill

Drill

EURO Series

EURO Series

Technical Data

Technical Data

Milling Conditions for CSS

◆ 2.5D flute length type $2 < L/D \leq 2.5$

WORK MATERIAL			CARBON STEELS S45C / S50C Annealed Materials (~225HB)			ALLOY STEELS SK / SCM Annealed Materials (225~325HB)			STAINLESS STEELS SUS304 * Use water soluble or oil coolant.		
Model Number	Outside Diameter (mm)	Length of Cut (mm)	Spindle Speed (min ⁻¹)	Feed Rate (mm/min)	Milling Amount (mm)	Spindle Speed (min ⁻¹)	Feed Rate (mm/min)	Milling Amount (mm)	Spindle Speed (min ⁻¹)	Feed Rate (mm/min)	Milling Amount (mm)
				Slotting	a_p		Slotting	a_p		Slotting	a_p
2001-0025	0.1	0.25	30,000	30	0.007	30,000	30	0.007	30,000	30	0.007
2002-0050	0.2	0.5	30,000	85	0.014	30,000	85	0.014	30,000	60	0.014
2003-0075	0.3	0.75	30,000	110	0.021	30,000	110	0.021	30,000	110	0.021
2004-0100	0.4	1	30,000	120	0.028	30,000	120	0.028	30,000	120	0.028
2005-0125	0.5	1.25	27,000	120	0.035	24,000	105	0.035	24,000	120	0.035
2006-0150	0.6	1.5	24,000	120	0.06	20,000	90	0.06	20,000	120	0.06
2007-0175	0.7	1.75	22,500	115	0.07	17,800	90	0.07	17,800	120	0.07
2008-0200	0.8	2	21,000	110	0.08	16,700	90	0.08	16,700	120	0.08
2009-0225	0.9	2.25	19,500	105	0.09	15,600	85	0.09	15,600	120	0.09
2010-0250	1	2.5	20,000	130	0.5	15,000	60	0.5	11,000	120	0.25
2015-0375	1.5	3.75	12,800	170	0.75	10,000	100	0.75	7,000	120	0.375
2020-0500	2	5	9,300	210	1	7,500	140	1	5,000	120	0.5
2025-0625	2.5	6.25	7,600	235	1.25	6,250	160	1.25	4,100	120	0.62
2030-0750	3	7.5	5,900	260	1.5	5,000	180	1.5	3,200	120	0.75
2040-1000	4	10	4,200	300	2	3,750	220	2	2,250	120	1
2050-1250	5	12.5	3,200	340	2.5	3,000	260	2.5	1,700	120	1.25
2060-1500	6	15	2,500	380	3	2,500	300	3	1,350	120	1.5
2070-1750	7	17.5	2,270	345	3.5	2,270	270	3.5	1,150	105	1.75
2080-2000	8	20	2,100	320	4	2,100	250	4	1,000	90	2
2090-2250	9	22.5	1,935	300	4.5	1,935	220	4.5	895	80	2.25
2100-2500	10	25	1,800	280	5	1,800	200	5	810	75	2.5
2110-2750	11	27.5	1,635	265	5.5	1,635	180	5.5	735	70	2.75
2120-3000	12	30	1,500	250	6	1,500	160	6	670	65	3

WORK MATERIAL			PREHARDENED STEELS HPM / NAK (30~45HRC)			HARDENED STEELS SKD / SKT / STAVAX (45~55HRC)		
Model Number	Outside Diameter (mm)	Length of Cut (mm)	Spindle Speed (min ⁻¹)	Feed Rate (mm/min)	Milling Amount (mm)	Spindle Speed (min ⁻¹)	Feed Rate (mm/min)	Milling Amount (mm)
				Slotting	a_p		Slotting	a_p
2001-0025	0.1	0.25	30,000	15	0.007	24,000	10	0.002
2002-0050	0.2	0.5	30,000	30	0.014	23,000	25	0.004
2003-0075	0.3	0.75	30,000	55	0.021	20,000	25	0.006
2004-0100	0.4	1	30,000	60	0.028	16,800	25	0.008
2005-0125	0.5	1.25	24,000	60	0.035	14,400	30	0.015
2006-0150	0.6	1.5	20,000	60	0.06	12,000	35	0.018
2007-0175	0.7	1.75	17,800	60	0.07	10,000	35	0.021
2008-0200	0.8	2	16,700	60	0.08	8,500	35	0.024
2009-0225	0.9	2.25	15,600	60	0.09	7,300	35	0.027
2010-0250	1	2.5	11,000	60	0.25	5,500	20	0.05
2015-0375	1.5	3.75	7,500	90	0.375	3,750	25	0.075
2020-0500	2	5	5,700	120	0.5	2,850	30	0.1
2025-0625	2.5	6.25	4,800	135	0.62	2,400	30	0.12
2030-0750	3	7.5	3,900	150	0.75	1,950	35	0.15
2040-1000	4	10	2,900	180	1	1,450	40	0.2
2050-1250	5	12.5	2,400	210	1.25	1,200	45	0.25
2060-1500	6	15	2,000	240	1.5	1,000	55	0.3
2070-1750	7	17.5	1,630	230	1.5	815	55	0.3
2080-2000	8	20	1,350	220	1.5	675	55	0.3
2090-2250	9	22.5	1,135	210	1.5	565	55	0.3
2100-2500	10	25	960	200	1.5	480	55	0.3
2110-2750	11	27.5	845	180	1.5	425	55	0.3
2120-3000	12	30	750	160	1.5	375	55	0.3

- UDC Series
- CBN Series
- Square
- Long Neck Square
- Radius
- Long Neck Radius
- Taper Neck Radius
- Ball / Long Shank Ball
- Long Neck Ball
- Taper Neck Ball
- Taper
- Spiral V Cutter
- Drill
- EURO Series
- Technical Data

Milling Conditions for CSS

◆ 3D flute length type L/D=3

WORK MATERIAL			CARBON STEELS S45C / S50C Annealed Materials (~225HB)			ALLOY STEELS SK / SCM Annealed Materials (225~325HB)			STAINLESS STEELS SUS304 * Use water soluble or oil coolant.		
Model Number	Outside Diameter (mm)	Length of Cut (mm)	Spindle Speed (min ⁻¹)	Feed Rate (mm/min)	Milling Amount (mm)	Spindle Speed (min ⁻¹)	Feed Rate (mm/min)	Milling Amount (mm)	Spindle Speed (min ⁻¹)	Feed Rate (mm/min)	Milling Amount (mm)
				Slotting	a_p		Slotting	a_p		Slotting	a_p
2001-0030	0.1	0.3	30,000	30	0.005	30,000	30	0.005	30,000	30	0.005
2002-0060	0.2	0.6	30,000	85	0.01	30,000	85	0.01	30,000	60	0.01
2003-0090	0.3	0.9	30,000	110	0.015	30,000	110	0.015	30,000	110	0.015
2004-0120	0.4	1.2	30,000	120	0.02	30,000	120	0.02	30,000	120	0.02
2005-0150	0.5	1.5	27,000	120	0.025	24,000	105	0.025	24,000	120	0.025
2006-0180	0.6	1.8	24,000	120	0.05	20,000	90	0.05	20,000	120	0.05
2007-0210	0.7	2.1	22,500	115	0.056	17,800	90	0.056	17,800	120	0.056
2008-0240	0.8	2.4	21,000	110	0.064	16,700	90	0.064	16,700	120	0.064
2009-0270	0.9	2.7	19,500	105	0.072	15,600	85	0.072	15,600	120	0.072
2010-0300	1	3	20,000	130	0.5	15,000	60	0.5	11,000	120	0.25
2015-0450	1.5	4.5	12,800	170	0.75	10,000	100	0.75	7,000	120	0.375
2020-0600	2	6	9,300	210	1	7,500	140	1	5,000	120	0.5
2025-0750	2.5	7.5	7,600	235	1.25	6,250	160	1.25	4,100	120	0.62
2030-0900	3	9	5,900	260	1.5	5,000	180	1.5	3,200	120	0.75
2040-1200	4	12	4,200	300	2	3,750	220	2	2,250	120	1
2050-1500	5	15	3,200	340	2.5	3,000	260	2.5	1,700	120	1.25
2060-1800	6	18	2,500	380	3	2,500	300	3	1,350	120	1.5
2070-2100	7	21	2,270	345	3.5	2,270	270	3.5	1,150	105	1.75
2080-2400	8	24	2,100	320	4	2,100	250	4	1,000	90	2
2090-2700	9	27	1,935	300	4.5	1,935	220	4.5	895	80	2.25
2100-3000	10	30	1,800	280	5	1,800	200	5	810	75	2.5
2110-3300	11	33	1,635	265	5.5	1,635	180	5.5	735	70	2.75
2120-3600	12	36	1,500	250	6	1,500	160	6	670	65	3

WORK MATERIAL			PREHARDENED STEELS HPM / NAK (30~45HRC)			HARDENED STEELS SKD / SKT / STAVAX (45~55HRC)		
Model Number	Outside Diameter (mm)	Length of Cut (mm)	Spindle Speed (min ⁻¹)	Feed Rate (mm/min)	Milling Amount (mm)	Spindle Speed (min ⁻¹)	Feed Rate (mm/min)	Milling Amount (mm)
				Slotting	a_p		Slotting	a_p
2001-0030	0.1	0.3	30,000	15	0.005	24,000	10	0.001
2002-0060	0.2	0.6	30,000	30	0.01	23,000	25	0.002
2003-0090	0.3	0.9	30,000	55	0.015	20,000	25	0.003
2004-0120	0.4	1.2	30,000	60	0.02	16,800	25	0.004
2005-0150	0.5	1.5	24,000	60	0.025	14,400	30	0.013
2006-0180	0.6	1.8	20,000	60	0.05	12,000	35	0.015
2007-0210	0.7	2.1	17,800	60	0.056	10,000	35	0.018
2008-0240	0.8	2.4	16,700	60	0.064	8,500	35	0.02
2009-0270	0.9	2.7	15,600	60	0.072	7,300	35	0.023
2010-0300	1	3	11,000	60	0.25	5,500	15	0.05
2015-0450	1.5	4.5	7,500	90	0.375	3,750	20	0.075
2020-0600	2	6	5,700	120	0.5	2,850	25	0.1
2025-0750	2.5	7.5	4,800	135	0.62	2,400	30	0.12
2030-0900	3	9	3,900	150	0.75	1,950	35	0.15
2040-1200	4	12	2,900	180	1	1,450	40	0.2
2050-1500	5	15	2,400	210	1.25	1,200	45	0.25
2060-1800	6	18	2,000	240	1.5	1,000	55	0.3
2070-2100	7	21	1,630	230	1.5	815	55	0.3
2080-2400	8	24	1,350	220	1.5	675	55	0.3
2090-2700	9	27	1,135	210	1.5	565	55	0.3
2100-3000	10	30	960	200	1.5	480	55	0.3
2110-3300	11	33	845	180	1.5	425	55	0.3
2120-3600	12	36	750	160	1.5	375	55	0.3

UDC Series

CBN Series

Square

Long Neck Square

Radius

Long Neck Radius

Taper Neck Radius

Ball / Long Shank Ball

Long Neck Ball

Taper Neck Ball

Taper

Spiral V Cutter

Drill

EURO Series

Technical Data

Milling Conditions for CSS

Side Milling

◆ 1D flute length type L/D=1

WORK MATERIAL			CARBON STEELS S45C / S50C Annealed Materials (~225HB)				ALLOY STEELS SK / SCM Annealed Materials (225~325HB)				STAINLESS STEELS SUS304 * Use water soluble or oil coolant.			
Model Number	Outside Diameter (mm)	Length of Cut (mm)	Spindle Speed (min ⁻¹)	Feed Rate (mm/min)	Milling Amount (mm)		Spindle Speed (min ⁻¹)	Feed Rate (mm/min)	Milling Amount (mm)		Spindle Speed (min ⁻¹)	Feed Rate (mm/min)	Milling Amount (mm)	
				Side Milling	a _p	a _e		Side Milling	a _p	a _e		Side Milling	a _p	a _e
2001-0010	0.1	0.1	30,000	70	0.1	0.007	30,000	55	0.1	0.006	30,000	60	0.1	0.005
2002-0020	0.2	0.2	30,000	180	0.2	0.014	30,000	140	0.2	0.012	30,000	120	0.2	0.01
2003-0030	0.3	0.3	30,000	280	0.3	0.021	30,000	210	0.3	0.018	30,000	180	0.3	0.015
2004-0040	0.4	0.4	30,000	380	0.4	0.028	30,000	260	0.4	0.024	30,000	225	0.4	0.02
2005-0050	0.5	0.5	27,000	490	0.5	0.035	24,000	360	0.5	0.03	24,000	315	0.5	0.025
2006-0060	0.6	0.6	24,000	600	0.6	0.042	20,000	450	0.6	0.036	20,000	400	0.6	0.03
2007-0070	0.7	0.7	22,500	600	0.7	0.049	17,800	450	0.7	0.042	17,800	400	0.7	0.035
2008-0080	0.8	0.8	21,000	600	0.8	0.056	16,700	450	0.8	0.048	16,700	400	0.8	0.04
2009-0090	0.9	0.9	19,500	600	0.9	0.063	15,600	450	0.9	0.054	15,600	400	0.9	0.045
2010-0100	1	1	18,000	600	1	0.075	14,500	450	1	0.075	14,500	500	1	0.05
2015-0150	1.5	1.5	16,000	900	1.5	0.113	13,000	600	1.5	0.113	13,000	750	1.5	0.075
2020-0200	2	2	12,000	900	2	0.15	10,000	600	2	0.15	10,000	750	2	0.1
2025-0250	2.5	2.5	10,200	900	2.5	0.19	8,400	600	2.5	0.19	8,400	750	2.5	0.13
2030-0300	3	3	8,500	900	3	0.225	6,800	600	3	0.225	6,800	750	3	0.15
2040-0400	4	4	7,200	675	4	0.6	5,700	500	4	0.6	5,700	575	4	0.4
2050-0500	5	5	6,000	750	5	0.75	4,800	550	5	0.75	4,800	650	5	0.5
2060-0600	6	6	5,000	800	6	0.9	4,000	600	6	0.9	4,000	650	6	0.6
2080-0800	8	8	3,500	700	8	1.2	2,700	525	8	1.2	2,400	600	8	0.8
2100-1000	10	10	2,300	600	10	1.5	1,900	450	10	1.5	1,400	500	10	1
2120-1200	12	12	1,850	550	12	1.8	1,550	400	12	1.8	1,250	450	12	1.2

WORK MATERIAL			PREHARDENED STEELS HPM / NAK (30~45HRC)				HARDENED STEELS SKD / SKT / STAVAX (45~55HRC)			
Model Number	Outside Diameter (mm)	Length of Cut (mm)	Spindle Speed (min ⁻¹)	Feed Rate (mm/min)	Milling Amount (mm)		Spindle Speed (min ⁻¹)	Feed Rate (mm/min)	Milling Amount (mm)	
				Side Milling	a _p	a _e		Side Milling	a _p	a _e
2001-0010	0.1	0.1	30,000	40	0.1	0.005	24,000	25	0.1	0.004
2002-0020	0.2	0.2	30,000	80	0.2	0.01	23,000	35	0.2	0.008
2003-0030	0.3	0.3	30,000	120	0.3	0.015	20,000	45	0.3	0.012
2004-0040	0.4	0.4	30,000	150	0.4	0.02	16,800	55	0.4	0.016
2005-0050	0.5	0.5	24,000	210	0.5	0.025	14,400	65	0.5	0.02
2006-0060	0.6	0.6	20,000	265	0.6	0.03	12,000	80	0.6	0.024
2007-0070	0.7	0.7	17,800	265	0.7	0.035	10,000	80	0.7	0.028
2008-0080	0.8	0.8	16,700	265	0.8	0.04	8,500	80	0.8	0.032
2009-0090	0.9	0.9	15,600	265	0.9	0.045	7,300	80	0.9	0.036
2010-0100	1	1	14,500	300	1	0.05	6,550	80	1	0.045
2015-0150	1.5	1.5	12,000	450	1.5	0.075	4,400	100	1.5	0.068
2020-0200	2	2	9,000	450	2	0.1	3,300	115	2	0.09
2025-0250	2.5	2.5	7,900	450	2.5	0.13	2,750	120	2.5	0.11
2030-0300	3	3	6,800	450	3	0.15	2,200	130	3	0.135
2040-0400	4	4	5,100	350	4	0.4	1,650	150	4	0.18
2050-0500	5	5	4,050	425	5	0.5	1,300	160	5	0.225
2060-0600	6	6	3,300	500	6	0.6	1,100	180	6	0.27
2080-0800	8	8	2,300	450	8	0.8	800	130	8	0.36
2100-1000	10	10	1,500	450	10	1	690	110	10	0.45
2120-1200	12	12	1,200	400	12	1.2	550	110	12	0.54

Milling Conditions for CSS

◆ 1.5D flute length type $1 < L/D \leq 1.5$

WORK MATERIAL			CARBON STEELS S45C / S50C Annealed Materials (~225HB)				ALLOY STEELS SK / SCM Annealed Materials (225~325HB)				STAINLESS STEELS SUS304 * Use water soluble or oil coolant.						
Model Number	Outside Diameter (mm)	Length of Cut (mm)	Spindle Speed (min ⁻¹)	Feed Rate (mm/min)		Milling Amount (mm)		Spindle Speed (min ⁻¹)	Feed Rate (mm/min)		Milling Amount (mm)		Spindle Speed (min ⁻¹)	Feed Rate (mm/min)		Milling Amount (mm)	
				Side Milling	a _p	a _e	Side Milling		a _p	a _e	Side Milling	a _p		a _e	Side Milling	a _p	a _e
2001-0015	0.1	0.15	30,000	70	0.15	0.007	30,000	55	0.15	0.006	30,000	60	0.15	0.005			
2002-0030	0.2	0.3	30,000	180	0.3	0.014	30,000	140	0.3	0.012	30,000	120	0.3	0.01			
2003-0045	0.3	0.45	30,000	280	0.45	0.021	30,000	210	0.45	0.018	30,000	180	0.45	0.015			
2004-0060	0.4	0.6	30,000	380	0.6	0.028	30,000	260	0.6	0.024	30,000	225	0.6	0.02			
2005-0075	0.5	0.75	27,000	490	0.75	0.035	24,000	360	0.75	0.03	24,000	315	0.75	0.025			
2006-0090	0.6	0.9	24,000	600	0.9	0.042	20,000	450	0.9	0.036	20,000	400	0.9	0.03			
2007-0100	0.7	1	22,500	600	1	0.049	17,800	450	1	0.042	17,800	400	1	0.035			
2008-0120	0.8	1.2	21,000	600	1.2	0.056	16,700	450	1.2	0.048	16,700	400	1.2	0.04			
2009-0120	0.9	1.2	19,500	600	1.2	0.063	15,600	450	1.2	0.054	15,600	400	1.2	0.045			
2010-0150	1	1.5	18,000	600	1.5	0.075	14,500	450	1.5	0.075	14,500	500	1.5	0.05			
2015-0225	1.5	2.25	16,000	900	2.25	0.113	13,000	600	2.25	0.113	13,000	750	2.25	0.075			
2020-0300	2	3	12,000	900	3	0.15	10,000	600	3	0.15	10,000	750	3	0.1			
2025-0375	2.5	3.75	10,200	900	3.75	0.19	8,400	600	3.75	0.19	8,400	750	3.75	0.13			
2030-0450	3	4.5	8,500	900	4.5	0.225	6,800	600	4.5	0.225	6,800	750	4.5	0.15			
2040-0600	4	6	7,200	675	6	0.6	5,700	500	6	0.6	5,700	575	6	0.4			
2050-0750	5	7.5	6,000	750	7.5	0.75	4,800	550	7.5	0.75	4,800	650	7.5	0.5			
2060-0900	6	9	5,000	800	9	0.9	4,000	600	9	0.9	4,000	650	9	0.6			
2080-1200	8	12	3,500	700	12	1.2	2,700	525	12	1.2	2,400	600	12	0.8			
2100-1500	10	15	2,300	600	15	1.5	1,900	450	15	1.5	1,400	500	15	1			
2120-1800	12	18	1,850	550	18	1.8	1,550	400	18	1.8	1,250	450	18	1.2			

WORK MATERIAL			PREHARDENED STEELS HPM / NAK (30~45HRC)				HARDENED STEELS SKD / SKT / STAVAX (45~55HRC)					
Model Number	Outside Diameter (mm)	Length of Cut (mm)	Spindle Speed (min ⁻¹)	Feed Rate (mm/min)		Milling Amount (mm)		Spindle Speed (min ⁻¹)	Feed Rate (mm/min)		Milling Amount (mm)	
				Side Milling	a _p	a _e	Side Milling		a _p	a _e		
2001-0015	0.1	0.15	30,000	40	0.15	0.005	24,000	25	0.15	0.004		
2002-0030	0.2	0.3	30,000	80	0.3	0.01	23,000	35	0.3	0.008		
2003-0045	0.3	0.45	30,000	120	0.45	0.015	20,000	45	0.45	0.012		
2004-0060	0.4	0.6	30,000	150	0.6	0.02	16,800	55	0.6	0.016		
2005-0075	0.5	0.75	24,000	210	0.75	0.025	14,400	65	0.75	0.02		
2006-0090	0.6	0.9	20,000	265	0.9	0.03	12,000	80	0.9	0.024		
2007-0100	0.7	1	17,800	265	1	0.035	10,000	80	1	0.028		
2008-0120	0.8	1.2	16,700	265	1.2	0.04	8,500	80	1.2	0.032		
2009-0120	0.9	1.2	15,600	265	1.2	0.045	7,300	80	1.2	0.036		
2010-0150	1	1.5	14,500	300	1.5	0.05	6,550	80	1	0.045		
2015-0225	1.5	2.25	12,000	450	2.25	0.075	4,400	100	1.5	0.068		
2020-0300	2	3	9,000	450	3	0.1	3,300	115	2	0.09		
2025-0375	2.5	3.75	7,900	450	3.75	0.13	2,750	120	2.5	0.11		
2030-0450	3	4.5	6,800	450	4.5	0.15	2,200	130	3	0.135		
2040-0600	4	6	5,100	350	6	0.4	1,650	150	4	0.18		
2050-0750	5	7.5	4,050	425	7.5	0.5	1,300	160	5	0.225		
2060-0900	6	9	3,300	500	9	0.6	1,100	180	6	0.27		
2080-1200	8	12	2,300	450	12	0.8	800	130	12	0.36		
2100-1500	10	15	1,500	450	15	1	690	110	15	0.45		
2120-1800	12	18	1,200	400	18	1.2	550	110	18	0.54		

UDC Series

CBN Series

Square

Long Neck Square

Radius

Long Neck Radius

Taper Neck Radius

Ball / Long Shank Ball

Long Neck Ball

Taper Neck Ball

Taper

Spiral V Cutter

Drill

EURO Series

Technical Data

Milling Conditions for CSS

◆ 2D flute length type $1.5 < L/D \leq 2$

WORK MATERIAL			CARBON STEELS S45C / S50C Annealed Materials (~225HB)				ALLOY STEELS SK / SCM Annealed Materials (225~325HB)				STAINLESS STEELS SUS304 * Use water soluble or oil coolant.			
Model Number	Outside Diameter (mm)	Length of Cut (mm)	Spindle Speed (min ⁻¹)	Feed Rate (mm/min)	Milling Amount (mm)		Spindle Speed (min ⁻¹)	Feed Rate (mm/min)	Milling Amount (mm)		Spindle Speed (min ⁻¹)	Feed Rate (mm/min)	Milling Amount (mm)	
				Side Milling	a _p	a _e		Side Milling	a _p	a _e		Side Milling	a _p	a _e
2001-0020	0.1	0.2	30,000	50	0.15	0.006	30,000	50	0.15	0.006	30,000	45	0.15	0.005
2002-0040	0.2	0.4	30,000	150	0.3	0.012	30,000	140	0.3	0.012	30,000	105	0.3	0.01
2003-0060	0.3	0.6	30,000	230	0.45	0.018	30,000	185	0.45	0.018	30,000	165	0.45	0.015
2004-0080	0.4	0.8	30,000	315	0.6	0.024	30,000	240	0.6	0.02	30,000	225	0.6	0.016
2005-0080	0.5	0.8	27,000	490	0.75	0.03	24,000	360	0.75	0.025	24,000	315	0.75	0.02
2005-0100	0.5	1	27,000	400	0.75	0.03	24,000	300	0.75	0.025	24,000	260	0.75	0.02
2006-0100	0.6	1	24,000	600	1	0.036	20,000	450	1	0.03	20,000	400	1	0.024
2006-0120	0.6	1.2	24,000	500	1.2	0.036	20,000	360	1.2	0.03	20,000	315	1.2	0.024
2007-0140	0.7	1.4	22,500	500	1.4	0.042	17,800	360	1.4	0.035	17,800	315	1.4	0.028
2008-0160	0.8	1.6	21,000	500	1.6	0.048	16,700	360	1.6	0.04	16,700	315	1.6	0.032
2009-0180	0.9	1.8	19,500	500	1.8	0.054	15,600	360	1.8	0.045	15,600	315	1.8	0.036
2010-0200	1	2	18,000	600	1.5	0.09	14,500	450	1.5	0.09	14,500	500	1.5	0.06
2015-0300	1.5	3	16,000	900	2.25	0.135	13,000	600	2.25	0.135	13,000	750	2.25	0.09
2020-0400	2	4	12,000	900	3	0.18	10,000	600	3	0.18	10,000	750	3	0.12
2025-0500	2.5	5	10,200	900	3.75	0.23	8,400	600	3.75	0.23	8,400	750	3.75	0.15
2030-0600	3	6	8,500	900	4.5	0.27	6,800	600	4.5	0.27	6,800	750	4.5	0.18
2040-0800	4	8	7,200	675	6	0.6	5,700	500	6	0.6	5,700	575	6	0.4
2050-1000	5	10	6,000	750	7.5	0.75	4,800	550	7.5	0.75	4,800	650	7.5	0.5
2060-1200	6	12	5,000	800	9	0.9	4,000	600	9	0.9	4,000	650	9	0.6
2080-1600	8	16	3,500	700	12	1.2	2,700	525	12	1.2	2,400	600	12	0.8
2100-2000	10	20	2,300	600	15	1.5	1,900	450	15	1.5	1,400	500	15	1
2120-2400	12	24	1,850	550	18	1.8	1,550	400	18	1.8	1,250	450	18	1.2

WORK MATERIAL			PREHARDENED STEELS HPM / NAK (30~45HRC)				HARDENED STEELS SKD / SKT / STAVAX (45~55HRC)			
Model Number	Outside Diameter (mm)	Length of Cut (mm)	Spindle Speed (min ⁻¹)	Feed Rate (mm/min)	Milling Amount (mm)		Spindle Speed (min ⁻¹)	Feed Rate (mm/min)	Milling Amount (mm)	
				Side Milling	a _p	a _e		Side Milling	a _p	a _e
2001-0020	0.1	0.2	30,000	30	0.15	0.005	24,000	10	0.2	0.003
2002-0040	0.2	0.4	30,000	70	0.3	0.01	23,000	30	0.4	0.006
2003-0060	0.3	0.6	30,000	110	0.45	0.015	20,000	40	0.6	0.009
2004-0080	0.4	0.8	30,000	150	0.6	0.016	16,800	50	0.8	0.012
2005-0080	0.5	0.8	24,000	210	0.75	0.02	14,400	65	0.8	0.015
2005-0100	0.5	1	24,000	175	0.75	0.02	14,400	50	1	0.015
2006-0100	0.6	1	20,000	265	1	0.024	12,000	80	1	0.018
2006-0120	0.6	1.2	20,000	210	1.2	0.024	12,000	60	1.2	0.018
2007-0140	0.7	1.4	17,800	210	1.4	0.028	10,000	60	1.4	0.021
2008-0160	0.8	1.6	16,700	210	1.6	0.032	8,500	60	1.6	0.024
2009-0180	0.9	1.8	15,600	210	1.8	0.036	7,300	60	1.8	0.027
2010-0200	1	2	14,500	300	1.5	0.06	6,550	80	1.5	0.045
2015-0300	1.5	3	12,000	450	2.25	0.09	4,400	100	2.25	0.068
2020-0400	2	4	9,000	450	3	0.12	3,300	115	3	0.09
2025-0500	2.5	5	7,900	450	3.75	0.15	2,750	120	3.75	0.11
2030-0600	3	6	6,800	450	4.5	0.18	2,200	130	4.5	0.135
2040-0800	4	8	5,100	350	6	0.4	1,650	150	6	0.18
2050-1000	5	10	4,050	425	7.5	0.5	1,300	160	7.5	0.225
2060-1200	6	12	3,300	500	9	0.6	1,100	180	9	0.27
2080-1600	8	16	2,300	450	12	0.8	800	130	12	0.36
2100-2000	10	20	1,500	450	15	1	690	110	15	0.45
2120-2400	12	24	1,200	400	18	1.2	550	110	18	0.54

- UDC Series
- CBN Series
- Square
- Long Neck Square
- Radius
- Long Neck Radius
- Taper Neck Radius
- Ball / Long Shank Ball
- Long Neck Ball
- Taper Neck Ball
- Taper
- Spiral V Cutter
- Drill
- EURO Series
- Technical Data

Milling Conditions for CSS

◆ 2.5D flute length type $2.5 < L/D \leq 3$

WORK MATERIAL			CARBON STEELS S45C / S50C Annealed Materials (~225HB)				ALLOY STEELS SK / SCM Annealed Materials (225~325HB)				STAINLESS STEELS SUS304 * Use water soluble or oil coolant.						
Model Number	Outside Diameter (mm)	Length of Cut (mm)	Spindle Speed (min ⁻¹)	Feed Rate (mm/min)		Milling Amount (mm)		Spindle Speed (min ⁻¹)	Feed Rate (mm/min)		Milling Amount (mm)		Spindle Speed (min ⁻¹)	Feed Rate (mm/min)		Milling Amount (mm)	
				Side Milling	a _p	a _e	Side Milling		a _p	a _e	Side Milling	a _p		a _e	Side Milling	a _p	a _e
2001-0025	0.1	0.25	30,000	40	0.2	0.005	30,000	40	0.2	0.005	30,000	25	0.2	0.004			
2002-0050	0.2	0.5	30,000	150	0.4	0.008	30,000	120	0.4	0.01	30,000	65	0.4	0.008			
2003-0075	0.3	0.75	30,000	230	0.6	0.012	30,000	160	0.6	0.015	30,000	100	0.6	0.012			
2004-0100	0.4	1	30,000	315	0.8	0.016	30,000	220	0.8	0.016	30,000	140	0.8	0.012			
2005-0125	0.5	1.25	27,000	400	1	0.02	24,000	260	1	0.02	24,000	155	1	0.015			
2006-0150	0.6	1.5	24,000	500	1.5	0.024	20,000	360	1.5	0.024	20,000	210	1.5	0.018			
2007-0175	0.7	1.75	22,500	500	1.75	0.028	17,800	360	1.75	0.028	17,800	210	1.75	0.021			
2008-0200	0.8	2	21,000	500	2	0.032	16,700	360	2	0.032	16,700	210	2	0.024			
2009-0225	0.9	2.25	19,500	500	2.25	0.036	15,600	360	2.25	0.036	15,600	210	2.25	0.027			
2010-0250	1	2.5	20,000	700	2.5	0.05	15,000	500	2.5	0.05	11,000	200	2.5	0.05			
2015-0375	1.5	3.75	12,800	710	3.75	0.075	10,000	500	3.75	0.075	7,000	210	3.75	0.075			
2020-0500	2	5	9,300	720	5	0.1	7,500	510	5	0.1	5,000	230	5	0.1			
2025-0625	2.5	6.25	7,600	725	6.25	0.13	6,250	515	6.25	0.13	4,100	250	6.25	0.13			
2030-0750	3	7.5	5,900	730	7.5	0.15	5,000	520	7.5	0.15	3,200	275	7.5	0.15			
2040-1000	4	10	4,200	740	10	0.4	3,750	520	10	0.4	2,250	300	10	0.2			
2050-1250	5	12.5	3,200	750	12.5	0.5	3,000	530	12.5	0.5	1,700	330	12.5	0.25			
2060-1500	6	15	2,500	750	15	0.6	2,500	530	15	0.6	1,350	350	15	0.3			
2070-1750	7	17.5	2,270	700	17.5	0.7	2,270	495	17.5	0.7	1,150	350	17.5	0.35			
2080-2000	8	20	2,100	660	20	0.8	2,100	470	20	0.8	1,000	350	20	0.4			
2090-2250	9	22.5	1,935	615	22.5	0.9	1,935	440	22.5	0.9	895	350	22.5	0.45			
2100-2500	10	25	1,800	580	25	1	1,800	410	25	1	810	350	25	0.5			
2110-2750	11	27.5	1,635	545	27.5	1.1	1,635	375	27.5	1.1	735	335	27.5	0.55			
2120-3000	12	30	1,500	520	30	1.2	1,500	350	30	1.2	670	320	30	0.6			

WORK MATERIAL			PREHARDENED STEELS HPM / NAK (30~45HRC)				HARDENED STEELS SKD / SKT / STAVAX (45~55HRC)					
Model Number	Outside Diameter (mm)	Length of Cut (mm)	Spindle Speed (min ⁻¹)	Feed Rate (mm/min)		Milling Amount (mm)		Spindle Speed (min ⁻¹)	Feed Rate (mm/min)		Milling Amount (mm)	
				Side Milling	a _p	a _e	Side Milling		a _p	a _e		
2001-0025	0.1	0.25	30,000	25	0.2	0.004	24,000	10	0.25	0.002		
2002-0050	0.2	0.5	30,000	65	0.4	0.008	23,000	25	0.5	0.004		
2003-0075	0.3	0.75	30,000	100	0.6	0.012	20,000	35	0.75	0.006		
2004-0100	0.4	1	30,000	140	0.8	0.012	16,800	45	1	0.008		
2005-0125	0.5	1.25	24,000	155	1	0.015	14,400	50	1.25	0.01		
2006-0150	0.6	1.5	20,000	210	1.5	0.018	12,000	60	1.5	0.012		
2007-0175	0.7	1.75	17,800	210	1.75	0.021	10,000	60	1.75	0.014		
2008-0200	0.8	2	16,700	210	2	0.024	8,500	60	2	0.016		
2009-0225	0.9	2.25	15,600	210	2.25	0.027	7,300	60	2.25	0.018		
2010-0250	1	2.5	11,000	200	2.5	0.05	5,500	60	2.5	0.05		
2015-0375	1.5	3.75	7,500	210	3.75	0.075	3,750	65	3.75	0.075		
2020-0500	2	5	5,700	230	5	0.1	2,850	70	5	0.1		
2025-0625	2.5	6.25	4,800	240	6.25	0.13	2,400	70	6.25	0.13		
2030-0750	3	7.5	3,900	250	7.5	0.15	1,950	75	7.5	0.15		
2040-1000	4	10	2,900	270	10	0.3	1,450	80	10	0.3		
2050-1250	5	12.5	2,400	290	12.5	0.375	1,200	90	12.5	0.375		
2060-1500	6	15	2,000	300	15	0.45	1,000	100	15	0.45		
2070-1750	7	17.5	1,630	285	17.5	0.525	815	85	17.5	0.525		
2080-2000	8	20	1,350	270	20	0.6	675	70	20	0.6		
2090-2250	9	22.5	1,135	255	22.5	0.675	565	60	22.5	0.675		
2100-2500	10	25	960	240	25	0.75	480	50	25	0.75		
2110-2750	11	27.5	845	220	27.5	0.825	425	45	27.5	0.825		
2120-3000	12	30	750	200	30	0.9	375	40	30	0.9		

UDC Series

CBN Series

Square

Square

Long Neck Square

Radius

Radius

Long Neck Radius

Taper Neck Radius

Ball / Long Shank Ball

Ball

Long Neck Ball

Taper Neck Ball

Taper

Taper

Spiral V Cutter

Drill

EURO Series

Technical Data

Milling Conditions for CSS

◆ 3D flute length type L/D=3

WORK MATERIAL			CARBON STEELS S45C / S50C Annealed Materials (~225HB)				ALLOY STEELS SK / SCM Annealed Materials (225~325HB)				STAINLESS STEELS SUS304 * Use water soluble or oil coolant.						
Model Number	Outside Diameter (mm)	Length of Cut (mm)	Spindle Speed (min ⁻¹)	Feed Rate (mm/min)		Milling Amount (mm)		Spindle Speed (min ⁻¹)	Feed Rate (mm/min)		Milling Amount (mm)		Spindle Speed (min ⁻¹)	Feed Rate (mm/min)		Milling Amount (mm)	
				Side Milling	a _p	a _e	Side Milling		a _p	a _e	Side Milling	a _p		a _e			
2001-0030	0.1	0.3	30,000	30	0.25	0.005	30,000	30	0.25	0.005	30,000	20	0.25	0.004			
2002-0060	0.2	0.6	30,000	110	0.5	0.008	30,000	85	0.5	0.01	30,000	50	0.5	0.008			
2003-0090	0.3	0.9	30,000	180	0.75	0.012	30,000	135	0.75	0.015	30,000	80	0.75	0.012			
2004-0120	0.4	1.2	30,000	250	1	0.016	30,000	170	1	0.016	30,000	100	1	0.012			
2005-0150	0.5	1.5	27,000	320	1.25	0.02	24,000	200	1.25	0.02	24,000	125	1.25	0.015			
2006-0180	0.6	1.8	24,000	400	1.8	0.024	20,000	280	1.8	0.024	20,000	170	1.8	0.018			
2007-0210	0.7	2.1	22,500	400	2.1	0.028	17,800	280	2.1	0.028	17,800	170	2.1	0.021			
2008-0240	0.8	2.4	21,000	400	2.4	0.032	16,700	280	2.4	0.032	16,700	170	2.4	0.024			
2009-0270	0.9	2.7	19,500	400	2.7	0.036	15,600	280	2.7	0.036	15,600	170	2.7	0.027			
2010-0300	1	3	20,000	700	3	0.05	15,000	500	3	0.05	11,000	200	3	0.05			
2015-0450	1.5	4.5	12,800	710	4.5	0.075	10,000	500	4.5	0.075	7,000	210	4.5	0.075			
2020-0600	2	6	9,300	720	6	0.1	7,500	510	6	0.1	5,000	230	6	0.1			
2025-0750	2.5	7.5	7,600	725	7.5	0.13	6,250	515	7.5	0.13	4,100	250	7.5	0.13			
2030-0900	3	9	5,900	730	9	0.15	5,000	520	9	0.15	3,200	275	9	0.15			
2040-1200	4	12	4,200	740	12	0.4	3,750	520	12	0.4	2,250	300	12	0.2			
2050-1500	5	15	3,200	750	15	0.5	3,000	530	15	0.5	1,700	330	15	0.25			
2060-1800	6	18	2,500	750	18	0.6	2,500	530	18	0.6	1,350	350	18	0.3			
2070-2100	7	21	2,270	700	21	0.7	2,270	495	21	0.7	1,150	350	21	0.35			
2080-2400	8	24	2,100	660	24	0.8	2,100	470	24	0.8	1,000	350	24	0.4			
2090-2700	9	27	1,935	615	27	0.9	1,935	440	27	0.9	895	350	27	0.45			
2100-3000	10	30	1,800	580	30	1	1,800	410	30	1	810	350	30	0.5			
2110-3300	11	33	1,635	545	33	1.1	1,635	375	33	1.1	735	335	33	0.55			
2120-3600	12	36	1,500	520	36	1.2	1,500	350	36	1.2	670	320	36	0.6			

WORK MATERIAL			PREHARDENED STEELS HPM / NAK (30~45HRC)				HARDENED STEELS SKD / SKT / STAVAX (45~55HRC)					
Model Number	Outside Diameter (mm)	Length of Cut (mm)	Spindle Speed (min ⁻¹)	Feed Rate (mm/min)		Milling Amount (mm)		Spindle Speed (min ⁻¹)	Feed Rate (mm/min)		Milling Amount (mm)	
				Side Milling	a _p	a _e	Side Milling		a _p	a _e		
2001-0030	0.1	0.3	30,000	20	0.25	0.004	24,000	10	0.3	0.002		
2002-0060	0.2	0.6	30,000	50	0.5	0.008	23,000	20	0.6	0.004		
2003-0090	0.3	0.9	30,000	80	0.75	0.012	20,000	35	0.9	0.003		
2004-0120	0.4	1.2	30,000	100	1	0.012	16,800	40	1.2	0.004		
2005-0150	0.5	1.5	24,000	125	1.25	0.015	14,400	50	1.5	0.005		
2006-0180	0.6	1.8	20,000	170	1.8	0.018	12,000	60	1.8	0.006		
2007-0210	0.7	2.1	17,800	170	2.1	0.021	10,000	60	2.1	0.007		
2008-0240	0.8	2.4	16,700	170	2.4	0.024	8,500	60	2.4	0.008		
2009-0270	0.9	2.7	15,600	170	2.7	0.027	7,300	60	2.7	0.009		
2010-0300	1	3	11,000	200	3	0.05	5,500	60	3	0.05		
2015-0450	1.5	4.5	7,500	210	4.5	0.075	3,750	65	4.5	0.075		
2020-0600	2	6	5,700	230	6	0.1	2,850	70	6	0.1		
2025-0750	2.5	7.5	4,800	240	7.5	0.13	2,400	70	7.5	0.13		
2030-0900	3	9	3,900	250	9	0.15	1,950	75	9	0.15		
2040-1200	4	12	2,900	270	12	0.3	1,450	80	12	0.3		
2050-1500	5	15	2,400	290	15	0.375	1,200	90	15	0.375		
2060-1800	6	18	2,000	300	18	0.45	1,000	100	18	0.45		
2070-2100	7	21	1,630	285	21	0.525	815	85	21	0.525		
2080-2400	8	24	1,350	270	24	0.6	675	70	24	0.6		
2090-2700	9	27	1,135	255	27	0.675	565	60	27	0.675		
2100-3000	10	30	960	240	30	0.75	480	50	30	0.75		
2110-3300	11	33	845	220	33	0.825	425	45	33	0.825		
2120-3600	12	36	750	200	36	0.9	375	40	36	0.9		

Milling Conditions for CSS

Note:

- Decrease both spindle speed and feed rate proportionally in case of chattering.
- These milling parameters are calculated based on the shortest overhang length. Longer overhangs may require an adjustment to the milling parameters.
- Reduce the milling amount and feed rate in accordance with required milling precision.
- Recommend water soluble or oil coolant.
- Recommend oil coolant for Titanium Alloys and Heat Resistant Alloys.

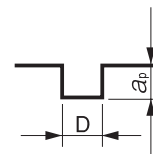

Slotting

a_p : Axial Depth (mm)

D : Outside Diameter (mm)

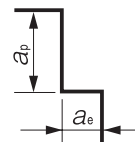

Side Milling

a_p : Axial Depth (mm)

a_e : Radial Depth (mm)

Original Cross Section

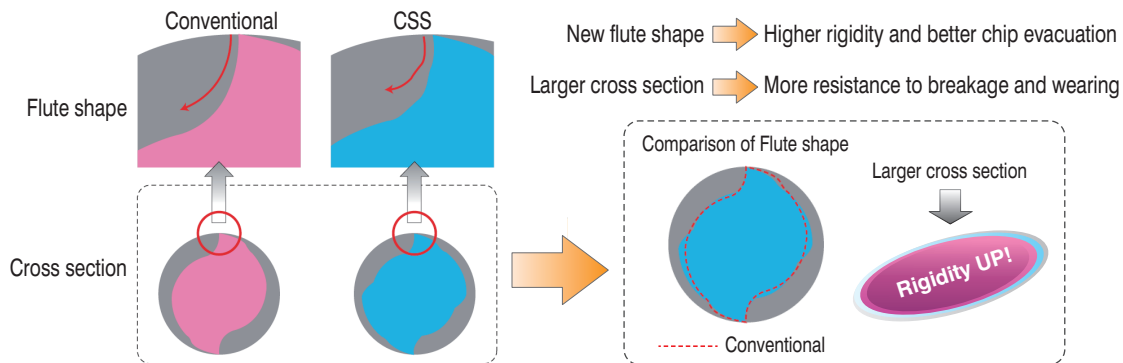

Milling Example: Slotting Comparison

STAVAX (53HRC)

Tool	$\phi 6 \times$ Length of Cut 12 mm
Spindle Speed	1,100 min^{-1}
Feed Rate	40 mm/min
Axial Depth a_p	1.8 mm
Coolant	Air Blow (Through Spindle)
Cycle Time	28 min



UDC Series

CBN Series

Square

Long Neck Square

Radius

Radius

Long Neck Radius

Taper Neck Radius

Ball

Ball / Long Shank Ball

Long Neck Ball

Taper Neck Ball

Taper

Taper

Spiral V Cutter

Drill

EURO Series

Technical Data

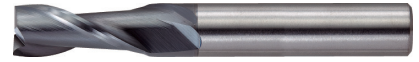

Size $\phi 0.1 \sim \phi 20$

C-CES2000



Material Applications (☆ Highly Recommended ○ Recommended ○ Suggested)

Work Material															
Carbon Steels S45C S55C	Alloy Steels SK / SCM SUS	Prehardened Steels NAK HPM	Hardened Steels			Cast Iron	Aluminum Alloys	Graphite	Copper	Plastics	Glass Filled Plastics	Titanium Alloys	Heat Resistant Alloys	Cemented Carbide	Hard Brittle (Non-Metallic) Materials
			~55HRC	~60HRC	~70HRC										
○	○	○	○			○			○			○	○		

Features

**Broad application range from Copper and Carbon Steels up to Hardened Steels (55HRC).
Excellent performance/quality to price ratio.
Refer to page 208 for 4 flute C-CES.**

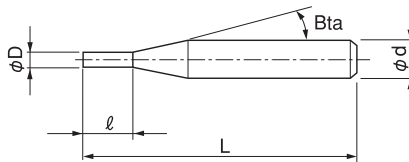

The shank taper angle shown is not an exact value and to avoid contact with the work piece, we recommend the user controls the precise value of this angle. Shank taper angle should not make contact with the work piece.

Total 207 models

Unit (mm)

Model Number	Outside Diameter ϕD	Length of Cut ℓ	Shank Taper Angle Bta	Overall Length L	Shank Diameter ϕd	Price ¥
C-CES 2001-0015	0.1	0.15	16°	45	4	7,800
C-CES 2001-0020		0.2		45	4	7,800
C-CES 2001-0030		0.3		45	4	7,800
C-CES 2002-0030	0.2	0.3	16°	45	4	4,680
C-CES 2002		0.4		38	3	4,680
C-CES 2002-0040		0.4		45	4	4,680
C-CES 2002-0050		0.5		45	4	4,680
C-CES 2002-0060		0.6		45	4	4,680
C-CES 2002-0080		0.8		45	4	7,930

Next Page ➡

Unit (mm)

Model Number	Outside Diameter ϕD	Length of Cut ℓ	Shank Taper Angle $B\alpha$	Overall Length L	Shank Diameter ϕd	Price ¥
C-CES 2003-0045	0.3	0.45	16°	45	4	4,080
C-CES 2003		0.6		38	3	4,080
C-CES 2003-0060		0.6		45	4	4,080
C-CES 2003-0075		0.75		45	4	4,080
C-CES 2003-0090		0.9		45	4	4,080
C-CES 2003-0120		1.2		45	4	6,120
C-CES 2004-0060	0.4	0.6	16°	45	4	4,560
C-CES 2004		0.8		38	3	4,560
C-CES 2004-0080		0.8		45	4	4,560
C-CES 2004-0100		1		45	4	4,560
C-CES 2004-0120		1.2		45	4	4,560
C-CES 2004-0160		1.6		45	4	6,120
C-CES 2005-0075	0.5	0.75	16°	45	4	2,280
C-CES 2005		0.8		38	3	2,280
C-CES 2005-0100		1		45	4	2,280
C-CES 2005-0125		1.25		45	4	2,280
C-CES 2005-0150		1.5		45	4	2,280
C-CES 2005-0200		2		45	4	3,840
C-CES 2006-0090	0.6	0.9	16°	45	4	3,480
C-CES 2006		1		38	3	3,480
C-CES 2006-0120		1.2		45	4	3,480
C-CES 2006-0150		1.5		45	4	3,480
C-CES 2006-0180		1.8		45	4	3,480
C-CES 2006-0240		2.4		45	4	3,480
C-CES 2007	0.7	1	16°	38	3	3,840
C-CES 2007-0140		1.4		45	4	3,840
C-CES 2007-0175		1.75		45	4	3,840
C-CES 2007-0210		2.1		45	4	3,840
C-CES 2007-0280		2.8		45	4	3,840
C-CES 2008	0.8	1.2	16°	38	3	2,280
C-CES 2008-0120		1.2		45	4	2,280
C-CES 2008-0160		1.6		45	4	2,280
C-CES 2008-0200		2		45	4	2,280
C-CES 2008-0240		2.4		45	4	2,280
C-CES 2008-0320		3.2		45	4	3,840
C-CES 2009	0.9	1.2	16°	38	3	3,840
C-CES 2009-0180		1.8		45	4	3,840
C-CES 2009-0225		2.25		45	4	3,840
C-CES 2009-0270		2.7		45	4	3,840
C-CES 2009-0360		3.6		45	4	3,840

Next Page ➡

UDC Series

CBN Series

Square

Long Neck Square

Radius

Long Neck Radius

Taper Neck Radius

Ball / Long Shank Ball

Long Neck Ball

Taper Neck Ball

Taper

Spiral V Cutter

Drill

EURO Series

Technical Data

Unit (mm)

Model Number	Outside Diameter ϕD	Length of Cut ℓ	Shank Taper Angle $B\alpha$	Overall Length L	Shank Diameter ϕd	Price ¥
C-CES 2010-0150	1	1.5	16°	45	4	2,040
C-CES 2010-0200		2		45	4	2,040
C-CES 2010		2.5		45	4	2,040
C-CES 2010-0300		3		45	4	2,040
C-CES 2010-0400		4		45	4	3,480
C-CES 2011	1.1	2.5	16°	45	4	4,320
C-CES 2012-0180	1.2	1.8	16°	45	4	2,280
C-CES 2012-0240		2.4		45	4	2,280
C-CES 2012-0300		3		45	4	2,280
C-CES 2012-0360		3.6		45	4	2,280
C-CES 2012		4		45	4	2,280
C-CES 2012-0480	4.8	45	4	3,480		
C-CES 2013	1.3	4	16°	45	4	4,320
C-CES 2014	1.4	4	16°	45	4	4,320
C-CES 2015-0225	1.5	2.25	16°	45	4	2,040
C-CES 2015-0300		3		45	4	2,040
C-CES 2015-0375		3.75		45	4	2,040
C-CES 2015		4		45	4	2,040
C-CES 2015-0450		4.5		45	4	2,040
C-CES 2015-0600	6	45	4	3,480		
C-CES 2016	1.6	5	16°	45	4	4,320
C-CES 2017	1.7	5	16°	45	4	4,320
C-CES 2018-0270	1.8	2.7	16°	45	4	2,280
C-CES 2018-0360		3.6		45	4	2,280
C-CES 2018-0450		4.5		45	4	2,280
C-CES 2018		5		45	4	2,280
C-CES 2018-0540		5.4		45	4	2,280
C-CES 2018-0720	7.2	45	4	4,200		
C-CES 2019	1.9	5	16°	45	4	4,440
C-CES 2020-0300	2	3	16°	45	4	2,040
C-CES 2020-0400		4		45	4	2,040
C-CES 2020-0500		5		45	4	2,040
C-CES 2020		6		45	4	2,040
C-CES 2020-0800		8		45	4	3,480
C-CES 2021	2.1	6	16°	45	4	4,320
C-CES 2022	2.2	6	16°	45	4	4,320
C-CES 2023	2.3	6	16°	45	4	4,320
C-CES 2024	2.4	8	16°	45	4	4,320

UDC Series

CBN Series

Square
Long Neck Square

Radius
Long Neck Radius
Taper Neck Radius

Ball / Long Shank Ball
Long Neck Ball

Taper

Spiral V Cutter

Drill

EURO Series

Technical Data

Unit (mm)

Model Number	Outside Diameter ϕD	Length of Cut ℓ	Shank Taper Angle Bta	Overall Length L	Shank Diameter ϕd	Price ¥
C-CES 2025-0375	2.5	3.75	16°	45	4	2,040
C-CES 2025-0500		5		45	4	2,040
C-CES 2025-0625		6.25		45	4	2,040
C-CES 2025-0750		7.5		45	4	2,040
C-CES 2025		8		45	4	2,040
C-CES 2025-1000		10		50	4	3,480
C-CES 2026	2.6	8	16°	45	6	5,520
C-CES 2027	2.7	8	16°	45	6	5,520
C-CES 2028	2.8	8	16°	45	6	5,520
C-CES 2029	2.9	8	16°	45	6	5,520
C-CES 2030-0450	3	4.5	16°	45	6	2,640
C-CES 2030-0600		6		45	6	2,640
C-CES 2030-0750		7.5		45	6	2,640
C-CES 2030		8		45	6	2,640
C-CES 2030-0900		9		45	6	2,640
C-CES 2030-1200		12		50	6	4,320
C-CES 2031	3.1	10	16°	45	6	5,760
C-CES 2032	3.2	10	16°	45	6	5,760
C-CES 2033	3.3	10	16°	45	6	5,760
C-CES 2034	3.4	10	16°	45	6	5,760
C-CES 2035	3.5	10	16°	45	6	4,680
C-CES 2036	3.6	10	16°	45	6	5,760
C-CES 2037	3.7	10	16°	45	6	5,760
C-CES 2038	3.8	11	16°	45	6	5,760
C-CES 2039	3.9	11	16°	45	6	5,760
C-CES 2040-0600	4	6	16°	50	6	2,880
C-CES 2040-0800		8		50	6	2,880
C-CES 2040-1000		10		50	6	2,880
C-CES 2040		11		45	6	2,880
C-CES 2040-1200		12		50	6	2,880
C-CES 2040-1600		16		60	6	4,680
C-CES 2041	4.1	11	16°	45	6	5,760
C-CES 2042	4.2	11	16°	45	6	5,760
C-CES 2043	4.3	11	16°	45	6	5,760
C-CES 2044	4.4	11	16°	45	6	5,760
C-CES 2045	4.5	11	16°	45	6	5,400
C-CES 2046	4.6	11	16°	45	6	6,600
C-CES 2047	4.7	11	16°	45	6	6,600
C-CES 2048	4.8	13	16°	50	6	6,600
C-CES 2049	4.9	13	16°	50	6	6,600

Next Page ➡

UDC Series

CBN Series

Square

Long Neck Square

Radius

Long Neck Radius

Taper Neck Radius

Ball / Long Shank Ball

Long Neck Ball

Taper Neck Ball

Taper

Spiral V Cutter

Drill

EURO Series

Technical Data

Unit (mm)

Model Number	Outside Diameter ϕD	Length of Cut ℓ	Shank Taper Angle Bta	Overall Length L	Shank Diameter ϕd	Price ¥
C-CES 2050-0750	5	7.5	16°	50	6	3,120
C-CES 2050-1000		10		50	6	3,120
C-CES 2050-1250		12.5		50	6	3,120
C-CES 2050		13		50	6	3,120
C-CES 2050-1500		15		50	6	3,120
C-CES 2050-2000		20		60	6	5,280
C-CES 2051	5.1	13	16°	50	6	6,600
C-CES 2052	5.2	13	16°	50	6	6,600
C-CES 2053	5.3	13	16°	50	6	6,600
C-CES 2054	5.4	13	16°	50	6	6,600
C-CES 2055	5.5	13	16°	50	6	5,640
C-CES 2056	5.6	13	16°	50	6	5,640
C-CES 2057	5.7	13	16°	50	6	5,640
C-CES 2058	5.8	13	16°	50	6	5,640
C-CES 2059	5.9	13	16°	50	6	5,640
C-CES 2060-0900	6	9	—	50	6	3,360
C-CES 2060-1200		12		50	6	3,360
C-CES 2060		13		50	6	3,360
C-CES 2060-1500		15		50	6	3,360
C-CES 2060-1800		18		50	6	3,360
C-CES 2060-2400		24		60	6	5,400
C-CES 2061	6.1	16	16°	60	8	10,340
C-CES 2062	6.2	16	16°	60	8	10,340
C-CES 2063	6.3	16	16°	60	8	10,340
C-CES 2064	6.4	16	16°	60	8	10,340
C-CES 2065	6.5	16	16°	60	8	9,280
C-CES 2066	6.6	16	16°	60	8	10,340
C-CES 2067	6.7	16	16°	60	8	10,340
C-CES 2068	6.8	16	16°	60	8	10,340
C-CES 2069	6.9	16	16°	60	8	10,340
C-CES 2070	7	16	16°	60	8	8,700
C-CES 2071	7.1	16	16°	60	8	10,340
C-CES 2072	7.2	16	16°	60	8	10,340
C-CES 2073	7.3	16	16°	60	8	10,340
C-CES 2074	7.4	16	16°	60	8	10,340
C-CES 2075	7.5	16	16°	60	8	10,360
C-CES 2076	7.6	19	16°	60	8	11,550
C-CES 2077	7.7	19	16°	60	8	11,550
C-CES 2078	7.8	19	16°	60	8	11,550
C-CES 2079	7.9	19	16°	60	8	11,550

UDC Series

CBN Series

Square
Long Neck Square

Radius

Radius
Long Neck Radius
Taper Neck Radius

Ball / Long Shank Ball
Long Neck Ball

Taper Neck Ball

Taper

Spiral V Cutter

Drill

EURO Series

Technical Data

Unit (mm)

Model Number	Outside Diameter ϕD	Length of Cut ℓ	Shank Taper Angle Bta	Overall Length L	Shank Diameter ϕd	Price ¥
C-CES 2080-1600	8	16	—	60	8	6,320
C-CES 2080		19		60	8	6,320
C-CES 2080-2000		20		60	8	6,320
C-CES 2080-2400		24		80	8	6,320
C-CES 2080-3200		32		80	8	11,520
C-CES 2081	8.1	19	16°	70	10	13,860
C-CES 2082	8.2	19	16°	70	10	13,860
C-CES 2083	8.3	19	16°	70	10	13,860
C-CES 2084	8.4	19	16°	70	10	13,860
C-CES 2085	8.5	19	16°	70	10	12,420
C-CES 2086	8.6	19	16°	70	10	13,860
C-CES 2087	8.7	19	16°	70	10	13,860
C-CES 2088	8.8	19	16°	70	10	13,860
C-CES 2089	8.9	19	16°	70	10	13,860
C-CES 2090	9	19	16°	70	10	12,420
C-CES 2091	9.1	19	16°	70	10	13,860
C-CES 2092	9.2	19	16°	70	10	13,860
C-CES 2093	9.3	19	16°	70	10	13,860
C-CES 2094	9.4	19	16°	70	10	13,860
C-CES 2095	9.5	19	16°	70	10	12,870
C-CES 2096	9.6	22	16°	70	10	14,300
C-CES 2097	9.7	22	16°	70	10	14,300
C-CES 2098	9.8	22	16°	70	10	14,300
C-CES 2099	9.9	22	16°	70	10	14,300
C-CES 2100-2000	10	20	—	70	10	7,580
C-CES 2100		22		70	10	7,580
C-CES 2100-2500		25		70	10	7,580
C-CES 2100-3000		30		80	10	7,580
C-CES 2100-4000		40		90	10	12,600
C-CES 2105	10.5	22	16°	75	12	18,920
C-CES 2110	11	22	16°	75	12	17,160
C-CES 2115	11.5	22	16°	75	12	19,580
C-CES 2120-2400	12	24	—	75	12	11,170
C-CES 2120		26		75	12	11,170
C-CES 2120-3000		30		75	12	11,170
C-CES 2120-3600		36		90	12	11,170
C-CES 2120-4800		48		100	12	22,490
C-CES 2160	16	32	—	110	16	35,530
C-CES 2180	18	32	16°	110	20	55,880
C-CES 2200	20	38	—	110	20	60,500

UDC Series

CBN Series

Square

Long Neck Square

Radius

Long Neck Radius

Taper Neck Radius

Ball / Long Shank Ball

Long Neck Ball

Taper Neck Ball

Taper

Spiral V Cutter

Drill

EURO Series

Technical Data

Milling Conditions for C-CES (2 Flutes)

WORK MATERIAL			CARBON STEELS S45C / S50C (~225HB)					ALLOY STEELS SK / SCM / SUS (225~325HB)				
Model Number	Outside Diameter (mm)	Length of Cut (mm)	Spindle Speed (min ⁻¹)	Feed Rate (mm/min)	Slotting	Side Milling		Spindle Speed (min ⁻¹)	Feed Rate (mm/min)	Slotting	Side Milling	
					a _p (mm)	a _p (mm)	a _e (mm)			a _p (mm)	a _e (mm)	
2001	0.1	0.15	30,000	30	0.01	0.15	0.01	30,000	30	0.01	0.15	0.01
		0.2	30,000	30	0.01	0.15	0.01	30,000	30	0.01	0.15	0.01
		0.3	30,000	30	0.005	0.25	0.005	30,000	30	0.005	0.25	0.005
		0.3	30,000	85	0.02	0.3	0.02	30,000	85	0.02	0.3	0.02
2002	0.2	0.4	30,000	85	0.02	0.3	0.02	30,000	85	0.02	0.3	0.02
		0.5	30,000	85	0.014	0.4	0.014	30,000	85	0.014	0.4	0.014
		0.6	30,000	85	0.01	0.5	0.01	30,000	85	0.01	0.5	0.01
		0.8	30,000	85	0.004	0.7	0.004	30,000	85	0.004	0.7	0.004
2003	0.3	0.45	30,000	110	0.03	0.45	0.03	30,000	110	0.03	0.45	0.03
		0.6	30,000	110	0.03	0.45	0.03	30,000	110	0.03	0.45	0.03
		0.75	30,000	110	0.021	0.6	0.021	30,000	110	0.021	0.6	0.021
		0.9	30,000	110	0.015	0.75	0.015	30,000	110	0.015	0.75	0.015
2004	0.4	1.2	30,000	110	0.006	1.05	0.006	30,000	110	0.006	1.05	0.006
		0.6	30,000	120	0.04	0.6	0.04	30,000	120	0.04	0.6	0.04
		0.8	30,000	120	0.04	0.6	0.04	30,000	120	0.04	0.6	0.04
		1	30,000	120	0.028	0.8	0.028	30,000	120	0.028	0.8	0.028
2005	0.5	1.2	30,000	120	0.02	1	0.02	30,000	120	0.02	1	0.02
		1.6	30,000	120	0.008	1.4	0.008	30,000	120	0.008	1.4	0.008
		0.75	30,000	120	0.05	0.75	0.05	29,000	120	0.05	0.75	0.05
		0.8	30,000	120	0.05	0.75	0.05	29,000	120	0.05	0.75	0.05
2006	0.6	1	30,000	120	0.05	0.75	0.05	29,000	120	0.05	0.75	0.05
		1.25	30,000	120	0.035	1	0.035	29,000	120	0.035	1	0.035
		1.5	30,000	120	0.025	1.25	0.025	29,000	120	0.025	1.25	0.025
		2	30,000	120	0.01	1.75	0.01	29,000	120	0.01	1.75	0.01
2007	0.7	0.9	30,000	120	0.06	0.9	0.06	24,000	120	0.06	0.9	0.06
		1	30,000	120	0.06	0.9	0.06	24,000	120	0.06	0.9	0.06
		1.2	30,000	120	0.06	0.9	0.06	24,000	120	0.06	0.9	0.06
		1.5	30,000	120	0.042	1.2	0.042	24,000	120	0.042	1.2	0.042
2008	0.8	1.8	30,000	120	0.03	1.5	0.03	24,000	120	0.03	1.5	0.03
		2.4	30,000	120	0.012	2.1	0.012	24,000	120	0.012	2.1	0.012
		1	27,500	120	0.07	1.05	0.07	21,000	120	0.07	1.05	0.07
		1.4	27,500	120	0.07	1.05	0.07	21,000	120	0.07	1.05	0.07
2009	0.9	1.75	27,500	120	0.049	1.4	0.049	21,000	120	0.049	1.4	0.049
		2.1	27,500	120	0.035	1.75	0.035	21,000	120	0.035	1.75	0.035
		2.8	27,500	120	0.014	2.45	0.014	21,000	120	0.014	2.45	0.014
		1.2	24,000	120	0.08	1.2	0.08	19,000	120	0.08	1.2	0.08
2010	1	1.6	24,000	120	0.08	1.2	0.08	19,000	120	0.08	1.2	0.08
		2	24,000	120	0.056	1.6	0.056	19,000	120	0.056	1.6	0.056
		2.4	24,000	120	0.04	2	0.04	19,000	120	0.04	2	0.04
		3.2	24,000	120	0.016	2.8	0.016	19,000	120	0.016	2.8	0.016
2011	1.2	1.2	21,500	125	0.09	1.35	0.09	16,500	120	0.09	1.35	0.09
		1.8	21,500	125	0.09	1.35	0.09	16,500	120	0.09	1.35	0.09
		2.25	21,500	125	0.063	1.8	0.063	16,500	120	0.063	1.8	0.063
		2.7	21,500	125	0.045	2.25	0.045	16,500	120	0.045	2.25	0.045
2012	1.5	3.6	21,500	125	0.018	3.15	0.018	16,500	120	0.018	3.15	0.018
		1.5	20,000	125	0.25	1.5	0.1	15,000	120	0.25	1.5	0.1
		2	20,000	125	0.25	1.5	0.1	15,000	120	0.25	1.5	0.1
		2.5	20,000	125	0.2	2	0.07	15,000	120	0.2	2	0.07
2013	1.8	3	20,000	125	0.125	2.5	0.05	15,000	120	0.125	2.5	0.05
		4	20,000	125	0.075	3.5	0.02	15,000	120	0.075	3.5	0.02
		1.8	16,700	130	0.3	1.8	0.12	12,500	120	0.3	1.8	0.12
		2.4	16,700	130	0.3	1.8	0.12	12,500	120	0.3	1.8	0.12
2014	1.2	3	16,700	130	0.24	2.4	0.084	12,500	120	0.24	2.4	0.084
		3.6	16,700	130	0.15	3	0.06	12,500	120	0.15	3	0.06
		4	16,700	130	0.09	4	0.024	12,500	120	0.09	4	0.024
		4.8	16,700	130	0.09	4.2	0.024	12,500	120	0.09	4.2	0.024
2015	1.5	2.25	13,500	130	0.375	2.25	0.15	10,000	120	0.375	2.25	0.15
		3	13,500	130	0.375	2.25	0.15	10,000	120	0.375	2.25	0.15
		3.75	13,500	130	0.3	3	0.105	10,000	120	0.3	3	0.105
		4	13,500	130	0.1875	3.75	0.075	10,000	120	0.1875	3.75	0.075
	1.5	4.5	13,500	130	0.1875	3.75	0.075	10,000	120	0.1875	3.75	0.075
		6	13,500	130	0.1125	5.25	0.03	10,000	120	0.1125	5.25	0.03

Milling Conditions for C-CES (2 Flutes)

WORK MATERIAL			PREHARDENED STEELS / HARDENED STEELS NAK / SKD (30~45HRC)					HARDENED STEELS SKD / SKT (45~55HRC)				
Model Number	Outside Diameter (mm)	Length of Cut (mm)	Spindle Speed (min ⁻¹)	Feed Rate (mm/min)	Slotting			Spindle Speed (min ⁻¹)	Feed Rate (mm/min)	Side Milling		
					a _p (mm)	a _p (mm)	a _e (mm)			a _p (mm)	a _p (mm)	a _e (mm)
2001	0.1	0.15	30,000	15	0.01	0.15	0.01	30,000	10	0.002	0.1	0.005
		0.2	30,000	15	0.01	0.15	0.01	30,000	10	0.002	0.1	0.005
		0.3	30,000	15	0.005	0.25	0.005	30,000	10	0.001	0.2	0.002
2002	0.2	0.3	30,000	30	0.02	0.3	0.02	30,000	25	0.004	0.2	0.01
		0.4	30,000	30	0.02	0.3	0.02	30,000	25	0.004	0.2	0.01
		0.5	30,000	30	0.014	0.4	0.014	30,000	25	0.004	0.3	0.006
		0.6	30,000	30	0.01	0.5	0.01	30,000	25	0.002	0.4	0.004
		0.8	30,000	30	0.004	0.7	0.004	30,000	25	0.002	0.6	0.002
2003	0.3	0.45	30,000	55	0.03	0.45	0.03	22,000	25	0.006	0.3	0.015
		0.6	30,000	55	0.03	0.45	0.03	22,000	25	0.006	0.3	0.015
		0.75	30,000	55	0.021	0.6	0.021	22,000	25	0.006	0.45	0.009
		0.9	30,000	55	0.015	0.75	0.015	22,000	25	0.003	0.6	0.006
		1.2	30,000	55	0.006	1.05	0.006	22,000	25	0.003	0.9	0.003
2004	0.4	0.6	27,000	60	0.04	0.6	0.04	17,000	25	0.008	0.4	0.02
		0.8	27,000	60	0.04	0.6	0.04	17,000	25	0.008	0.4	0.02
		1	27,000	60	0.028	0.8	0.028	17,000	25	0.008	0.6	0.012
		1.2	27,000	60	0.02	1	0.02	17,000	25	0.004	0.8	0.008
		1.6	27,000	60	0.008	1.4	0.008	17,000	25	0.004	1.2	0.004
2005	0.5	0.75	21,500	60	0.05	0.75	0.05	13,000	25	0.01	0.5	0.025
		0.8	21,500	60	0.05	0.75	0.05	13,000	25	0.01	0.5	0.025
		1	21,500	60	0.05	0.75	0.05	13,000	25	0.01	0.5	0.025
		1.25	21,500	60	0.035	1	0.035	13,000	25	0.01	0.75	0.015
2006	0.6	1.5	21,500	60	0.025	1.25	0.025	13,000	25	0.005	1	0.01
		2	21,500	60	0.01	1.75	0.01	13,000	25	0.005	1.5	0.005
		0.9	18,000	60	0.06	0.9	0.06	11,000	25	0.012	0.6	0.03
		1	18,000	60	0.06	0.9	0.06	11,000	25	0.012	0.6	0.03
		1.2	18,000	60	0.06	0.9	0.06	11,000	25	0.012	0.6	0.03
2007	0.7	1.5	18,000	60	0.042	1.2	0.042	11,000	25	0.012	0.9	0.018
		1.8	18,000	60	0.03	1.5	0.03	11,000	25	0.006	1.2	0.012
		2.4	18,000	60	0.012	2.1	0.012	11,000	25	0.006	1.8	0.006
		1	15,500	60	0.07	1.05	0.07	10,000	25	0.014	0.7	0.035
		1.4	15,500	60	0.07	1.05	0.07	10,000	25	0.014	0.7	0.035
2008	0.8	1.75	15,500	60	0.049	1.4	0.049	10,000	25	0.014	1.05	0.021
		2.1	15,500	60	0.035	1.75	0.035	10,000	25	0.007	1.4	0.014
		2.8	15,500	60	0.014	2.45	0.014	10,000	25	0.007	2.1	0.007
		1.2	13,800	60	0.08	1.2	0.08	8,800	30	0.016	0.8	0.04
		1.6	13,800	60	0.08	1.2	0.08	8,800	30	0.016	0.8	0.04
2009	0.9	2	13,800	60	0.056	1.6	0.056	8,800	30	0.016	1.2	0.024
		2.4	13,800	60	0.04	2	0.04	8,800	30	0.008	1.6	0.016
		3.2	13,800	60	0.016	2.8	0.016	8,800	30	0.008	2.4	0.008
		1.2	12,000	65	0.09	1.35	0.09	7,800	30	0.018	0.9	0.045
		1.8	12,000	65	0.09	1.35	0.09	7,800	30	0.018	0.9	0.045
2010	1	2.25	12,000	65	0.063	1.8	0.063	7,800	30	0.018	1.35	0.027
		2.7	12,000	65	0.045	2.25	0.045	7,800	30	0.009	1.8	0.018
		3.6	12,000	65	0.018	3.15	0.018	7,800	30	0.009	2.7	0.009
		1.5	11,000	65	0.25	1.5	0.1	7,100	30	0.05	1	0.05
		2	11,000	65	0.25	1.5	0.1	7,100	30	0.05	1	0.05
2012	1.2	2.5	11,000	65	0.2	2	0.07	7,100	30	0.03	1.5	0.03
		3	11,000	65	0.125	2.5	0.05	7,100	30	0.02	2	0.02
		4	11,000	65	0.075	3.5	0.02	7,100	30	0.01	3	0.01
		1.8	9,400	65	0.3	1.8	0.12	6,000	30	0.06	1.2	0.06
		2.4	9,400	65	0.3	1.8	0.12	6,000	30	0.06	1.2	0.06
2015	1.5	3	9,400	65	0.24	2.4	0.084	6,000	30	0.036	1.8	0.036
		3.6	9,400	65	0.15	3	0.06	6,000	30	0.024	2.4	0.024
		4	9,400	65	0.09	4	0.024	6,000	30	0.012	3.6	0.012
		4.8	9,400	65	0.09	4.2	0.024	6,000	30	0.012	3.6	0.012
		2.25	8,000	70	0.375	2.25	0.15	5,100	35	0.075	1.5	0.075
2015	1.5	3	8,000	70	0.375	2.25	0.15	5,100	35	0.075	1.5	0.075
		3.75	8,000	70	0.3	3	0.105	5,100	35	0.045	2.25	0.045
		4	8,000	70	0.1875	3.75	0.075	5,100	35	0.03	3	0.03
		4.5	8,000	70	0.1875	3.75	0.075	5,100	35	0.03	3	0.03
		6	8,000	70	0.1125	5.25	0.03	5,100	35	0.015	4.5	0.015

UDC Series

CBN Series

Square

Long Neck Square

Radius

Long Neck Radius

Taper Neck Radius

Ball / Long Shank Ball

Long Neck Ball

Taper Neck Ball

Taper

Spiral V Cutter

Drill

EURO Series

Technical Data

Milling Conditions for C-CES (2 Flutes)

WORK MATERIAL			CARBON STEELS S45C / S50C (~225HB)					ALLOY STEELS SK / SCM / SUS (225~325HB)						
Model Number	Outside Diameter (mm)	Length of Cut (mm)	Spindle Speed (min ⁻¹)	Feed Rate (mm/min)	Slotting		Side Milling		Spindle Speed (min ⁻¹)	Feed Rate (mm/min)	Slotting		Side Milling	
					a _p (mm)	a _e (mm)	a _p (mm)	a _e (mm)			a _p (mm)	a _e (mm)		
UDC Series	2018	1.8	2.7	11,500	130	0.45	2.7	0.18	8,800	120	0.45	2.7	0.18	
			3.6	11,500	130	0.45	2.7	0.18	8,800	120	0.45	2.7	0.18	
			4.5	11,500	130	0.36	3.6	0.126	8,800	120	0.36	3.6	0.126	
			5	11,500	130	0.225	4.5	0.09	8,800	120	0.225	4.5	0.09	
			5.4	11,500	130	0.225	4.5	0.09	8,800	120	0.225	4.5	0.09	
CBN Series	2020	2	7.2	11,500	130	0.135	6.3	0.036	8,800	120	0.135	6.3	0.036	
			3	11,000	130	0.5	3	0.2	8,500	120	0.5	3	0.2	
			4	11,000	130	0.5	3	0.2	8,500	120	0.5	3	0.2	
			5	11,000	130	0.4	4	0.14	8,500	120	0.4	4	0.14	
			6	11,000	130	0.25	5	0.1	8,500	120	0.25	5	0.1	
Square	2025	2.5	8	11,000	130	0.15	7	0.04	8,500	120	0.15	7	0.04	
			3.75	8,800	195	0.625	3.75	0.25	7,000	135	0.625	3.75	0.25	
			5	8,800	195	0.625	3.75	0.25	7,000	135	0.625	3.75	0.25	
			6.25	8,800	195	0.5	5	0.175	7,000	135	0.5	5	0.175	
			7.5	8,800	195	0.3125	6.25	0.125	7,000	135	0.3125	6.25	0.125	
Long Neck Square	2030	3	8	8,800	195	0.1875	8	0.05	7,000	135	0.1875	8	0.05	
			10	8,800	195	0.1875	8.75	0.05	7,000	135	0.1875	8.75	0.05	
			4.5	7,400	195	1.5	4.5	0.3	6,400	145	1.5	4.5	0.3	
			6	7,400	195	1.5	4.5	0.3	6,400	145	1.5	4.5	0.3	
			7.5	7,400	195	1.2	6	0.21	6,400	145	1.2	6	0.21	
Radius	2040	4	8	7,400	195	0.9	7.5	0.15	6,400	145	0.9	7.5	0.15	
			9	7,400	195	0.9	7.5	0.15	6,400	145	0.9	7.5	0.15	
			12	7,400	195	0.45	10.5	0.06	6,400	145	0.45	10.5	0.06	
			6	5,900	230	2	6	0.4	5,000	190	2	6	0.4	
			8	5,900	230	2	6	0.4	5,000	190	2	6	0.4	
Long Neck Radius	2050	5	10	5,900	230	1.6	8	0.28	5,000	190	1.6	8	0.28	
			11	5,900	230	1.2	10	0.2	5,000	190	1.2	10	0.2	
			12	5,900	230	1.2	10	0.2	5,000	190	1.2	10	0.2	
			16	5,900	230	0.6	14	0.08	5,000	190	0.6	14	0.08	
			7.5	5,300	310	2.5	7.5	0.5	4,200	230	2.5	7.5	0.5	
Ball / Long Shank Ball	2060	6	10	5,300	310	2.5	7.5	0.5	4,200	230	2.5	7.5	0.5	
			12.5	5,300	310	2	10	0.35	4,200	230	2	10	0.35	
			13	5,300	310	1.5	12.5	0.25	4,200	230	1.5	12.5	0.25	
			15	5,300	310	1.5	12.5	0.25	4,200	230	1.5	12.5	0.25	
			20	5,300	310	0.75	17.5	0.1	4,200	230	0.75	17.5	0.1	
Long Neck Ball	2080	8	9	4,400	305	3	9	0.6	3,500	230	3	9	0.6	
			12	4,400	305	3	9	0.6	3,500	230	3	9	0.6	
			13	4,400	305	2.4	12	0.42	3,500	230	2.4	12	0.42	
			15	4,400	305	2.4	15	0.42	3,500	230	2.4	12	0.42	
			18	4,400	305	1.8	15	0.3	3,500	230	1.8	15	0.3	
Taper	2100	10	24	4,400	305	0.9	21	0.12	3,500	230	0.9	21	0.12	
			16	3,300	290	4	12	0.8	2,600	230	4	12	0.8	
			19	3,300	290	3.2	16	0.56	2,600	230	3.2	16	0.56	
			20	3,300	290	3.2	16	0.56	2,600	230	3.2	16	0.56	
			24	3,300	290	2.4	20	0.4	2,600	230	2.4	20	0.4	
Spiral V Cutter	2120	12	32	3,300	290	1.2	28	0.16	2,600	230	1.2	28	0.16	
			20	2,600	275	5	15	1	2,100	225	5	15	1	
			22	2,600	275	4	20	0.7	2,100	225	4	20	0.7	
			25	2,600	275	4	20	0.7	2,100	225	4	20	0.7	
			30	2,600	275	3	25	0.5	2,100	225	3	25	0.5	
Drill	2120	12	40	2,600	275	1.5	35	0.2	2,100	225	1.5	35	0.2	
			24	2,200	275	6	18	1.2	1,750	225	6	18	1.2	
			26	2,200	275	4.8	24	0.84	1,750	225	4.8	24	0.84	
			30	2,200	275	4.8	24	0.84	1,750	225	4.8	24	0.84	
			36	2,200	275	3.6	30	0.6	1,750	225	3.6	30	0.6	
EURO Series	2120	12	48	2,200	275	1.8	42	0.24	1,750	225	1.8	42	0.24	
			48	2,200	275	1.8	42	0.24	1,750	225	1.8	42	0.24	

Milling Conditions for C-CES (2 Flutes)

WORK MATERIAL			PREHARDENED STEELS / HARDENED STEELS NAK / SKD (30~45HRC)					HARDENED STEELS SKD / SKT (45~55HRC)				
Model Number	Outside Diameter (mm)	Length of Cut (mm)	Spindle Speed (min ⁻¹)	Feed Rate (mm/min)	Side Milling			Spindle Speed (min ⁻¹)	Feed Rate (mm/min)	Side Milling		
					Slotting a _p (mm)	a _p (mm)	a _e (mm)			Slotting a _p (mm)	a _p (mm)	a _e (mm)
2018	1.8	2.7	7,000	70	0.45	2.7	0.18	4,400	35	0.09	1.8	0.09
		3.6	7,000	70	0.45	2.7	0.18	4,400	35	0.09	1.8	0.09
		4.5	7,000	70	0.36	3.6	0.126	4,400	35	0.054	2.7	0.054
		5	7,000	70	0.225	4.5	0.09	4,400	35	0.036	3.6	0.036
		5.4	7,000	70	0.225	4.5	0.09	4,400	35	0.036	3.6	0.036
7.2	7,000	70	0.135	6.3	0.036	4,400	35	0.018	5.4	0.018		
2020	2	3	6,400	70	0.5	3	0.2	4,000	40	0.1	2	0.1
		4	6,400	70	0.5	3	0.2	4,000	40	0.1	2	0.1
		5	6,400	70	0.4	4	0.14	4,000	40	0.06	3	0.06
		6	6,400	70	0.25	5	0.1	4,000	40	0.04	4	0.04
		8	6,400	70	0.15	7	0.04	4,000	40	0.02	6	0.02
2025	2.5	3.75	5,000	70	0.625	3.75	0.25	3,200	40	0.125	2.5	0.125
		5	5,000	70	0.625	3.75	0.25	3,200	40	0.125	2.5	0.125
		6.25	5,000	70	0.5	5	0.175	3,200	40	0.075	3.75	0.075
		7.5	5,000	70	0.3125	6.25	0.125	3,200	40	0.05	5	0.05
		8	5,000	70	0.1875	8	0.05	3,200	40	0.025	7.5	0.025
10	5,000	70	0.1875	8.75	0.05	3,200	40	0.025	7.5	0.025		
2030	3	4.5	4,500	80	1.5	4.5	0.3	2,800	45	0.15	3	0.15
		6	4,500	80	1.5	4.5	0.3	2,800	45	0.15	3	0.15
		7.5	4,500	80	1.2	6	0.21	2,800	45	0.09	4.5	0.09
		8	4,500	80	0.9	7.5	0.15	2,800	45	0.06	6	0.06
		9	4,500	80	0.9	7.5	0.15	2,800	45	0.06	6	0.06
12	4,500	80	0.45	10.5	0.06	2,800	45	0.03	9	0.03		
2040	4	6	3,500	90	2	6	0.4	2,150	50	0.2	4	0.2
		8	3,500	90	2	6	0.4	2,150	50	0.2	4	0.2
		10	3,500	90	1.6	8	0.28	2,150	50	0.12	6	0.12
		11	3,500	90	1.2	10	0.2	2,150	50	0.08	8	0.08
		12	3,500	90	1.2	10	0.2	2,150	50	0.08	8	0.08
16	3,500	90	0.6	14	0.08	2,150	50	0.04	12	0.04		
2050	5	7.5	2,950	90	2.5	7.5	0.5	1,850	55	0.25	5	0.25
		10	2,950	90	2.5	7.5	0.5	1,850	55	0.25	5	0.25
		12.5	2,950	90	2	10	0.35	1,850	55	0.15	7.5	0.15
		13	2,950	90	1.5	12.5	0.25	1,850	55	0.1	10	0.1
		15	2,950	90	1.5	12.5	0.25	1,850	55	0.1	10	0.1
20	2,950	90	0.75	17.5	0.1	1,850	55	0.05	15	0.05		
2060	6	9	2,450	100	3	9	0.6	1,500	55	0.3	6	0.3
		12	2,450	100	3	9	0.6	1,500	55	0.3	6	0.3
		13	2,450	100	2.4	12	0.42	1,500	55	0.18	9	0.18
		15	2,450	100	2.4	12	0.42	1,500	55	0.18	9	0.18
		18	2,450	100	1.8	15	0.3	1,500	55	0.12	12	0.12
24	2,450	100	0.9	21	0.12	1,500	55	0.06	18	0.06		
2080	8	16	1,850	95	4	12	0.8	1,200	50	0.4	8	0.4
		19	1,850	95	3.2	16	0.56	1,200	50	0.24	12	0.24
		20	1,850	95	3.2	16	0.56	1,200	50	0.24	12	0.24
		24	1,850	95	2.4	20	0.4	1,200	50	0.16	16	0.16
		32	1,850	95	1.2	28	0.16	1,200	50	0.08	24	0.08
2100	10	20	1,450	95	5	15	1	950	50	0.5	10	0.5
		22	1,450	95	4	20	0.7	950	50	0.3	15	0.3
		25	1,450	95	4	20	0.7	950	50	0.3	15	0.3
		30	1,450	95	3	25	0.5	950	50	0.2	20	0.2
		40	1,450	95	1.5	35	0.2	950	50	0.1	30	0.1
2120	12	24	1,200	90	6	18	1.2	800	45	0.6	12	0.6
		26	1,200	90	4.8	24	0.84	800	45	0.36	18	0.36
		30	1,200	90	4.8	24	0.84	800	45	0.36	18	0.36
		36	1,200	90	3.6	30	0.6	800	45	0.24	24	0.24
		48	1,200	90	1.8	42	0.24	800	45	0.12	36	0.12

UDC Series

CBN Series

Square

Long Neck Square

Radius

Long Neck Radius

Taper Neck Radius

Ball / Long Shank Ball

Long Neck Ball

Taper Neck Ball

Taper

Spiral V Cutter

Drill

EURO Series

Technical Data

Milling Conditions for C-CES (2 Flutes)

◆High speed milling

WORK MATERIAL			CARBON STEELS S45C / S50C (~225HB)					ALLOY STEELS SK / SCM / SUS (225~325HB)				
Model Number	Outside Diameter (mm)	Length of Cut (mm)	Spindle Speed (min ⁻¹)	Feed Rate (mm/min)	Slotting			Spindle Speed (min ⁻¹)	Feed Rate (mm/min)	Side Milling		
					a _p (mm)	a _p (mm)	a _e (mm)			a _p (mm)	a _p (mm)	a _e (mm)
2030	3	4.5	30,000	790	1.5	4.5	0.3	26,500	600	1.5	4.5	0.3
		6	30,000	790	1.5	4.5	0.3	26,500	600	1.5	4.5	0.3
		7.5	30,000	790	1.2	6	0.21	26,500	600	1.2	6	0.21
		8	30,000	790	0.9	7.5	0.15	26,500	600	0.9	7.5	0.15
		9	30,000	790	0.9	7.5	0.15	26,500	600	0.9	7.5	0.15
		12	30,000	790	0.45	10.5	0.06	26,500	600	0.45	10.5	0.06
2040	4	6	23,800	930	2	6	0.4	19,800	750	2	6	0.4
		8	23,800	930	2	6	0.4	19,800	750	2	6	0.4
		10	23,800	930	1.6	8	0.28	19,800	750	1.6	8	0.28
		11	23,800	930	1.2	10	0.2	19,800	750	1.2	10	0.2
		12	23,800	930	1.2	10	0.2	19,800	750	1.2	10	0.2
		16	23,800	930	0.6	14	0.08	19,800	750	0.6	14	0.08
2050	5	7.5	19,000	1,110	2.5	7.5	0.5	15,800	865	2.5	7.5	0.5
		10	19,000	1,110	2.5	7.5	0.5	15,800	865	2.5	7.5	0.5
		12.5	19,000	1,110	2	10	0.35	15,800	865	2	10	0.35
		13	19,000	1,110	1.5	12.5	0.25	15,800	865	1.5	12.5	0.25
		15	19,000	1,110	1.5	12.5	0.25	15,800	865	1.5	12.5	0.25
		20	19,000	1,110	0.75	17.5	0.1	15,800	865	0.75	17.5	0.1
2060	6	9	15,900	1,110	3	9	0.6	13,200	865	3	9	0.6
		12	15,900	1,110	3	9	0.6	13,200	865	3	9	0.6
		13	15,900	1,110	2.4	12	0.42	13,200	865	2.4	12	0.42
		15	15,900	1,110	2.4	12	0.42	13,200	865	2.4	12	0.42
		18	15,900	1,110	1.8	15	0.3	13,200	865	1.8	15	0.3
		24	15,900	1,110	0.9	21	0.12	13,200	865	0.9	21	0.12
2080	8	16	11,900	1,045	4	12	0.8	9,900	875	4	12	0.8
		19	11,900	1,045	3.2	16	0.56	9,900	875	3.2	16	0.56
		20	11,900	1,045	3.2	16	0.56	9,900	875	3.2	16	0.56
		24	11,900	1,045	2.4	20	0.4	9,900	875	2.4	20	0.4
		32	11,900	1,045	1.2	28	0.16	9,900	875	1.2	28	0.16
		20	9,500	1,005	5	15	1	7,900	845	5	15	1
2100	10	22	9,500	1,005	4	20	0.7	7,900	845	4	20	0.7
		25	9,500	1,005	4	20	0.7	7,900	845	4	20	0.7
		30	9,500	1,005	3	25	0.5	7,900	845	3	25	0.5
		24	7,900	1,000	6	18	1.2	6,600	850	6	18	1.2
2120	12	26	7,900	1,000	4.8	24	0.84	6,600	850	4.8	24	0.84
		30	7,900	1,000	4.8	24	0.84	6,600	850	4.8	24	0.84
		36	7,900	1,000	3.6	30	0.6	6,600	850	3.6	30	0.6
		48	7,900	1,000	1.8	42	0.24	6,600	850	1.8	42	0.24

UDC Series

CBN Series

Square
Long Neck Square

Radius
Long Neck Radius

Taper Neck Radius
Ball / Long Shank Ball

Ball
Long Neck Ball
Taper Neck Ball

Taper

Spiral V Cutter

Drill

EURO Series

Technical Data

Milling Conditions for C-CES (2 Flutes)

WORK MATERIAL			PREHARDENED STEELS / HARDENED STEELS NAK / SKD (30~45HRC)					HARDENED STEELS SKD / SKT (45~55HRC)						
Model Number	Outside Diameter (mm)	Length of Cut (mm)	Spindle Speed (min ⁻¹)	Feed Rate (mm/min)	Slotting		Side Milling		Spindle Speed (min ⁻¹)	Feed Rate (mm/min)	Slotting		Side Milling	
					a _p (mm)	a _e (mm)	a _p (mm)	a _e (mm)			a _p (mm)	a _e (mm)	a _p (mm)	a _e (mm)
2030	3	4.5	21,200	375	1.5	4.5	0.3	15,800	255	0.15	3	0.15		
		6	21,200	375	1.5	4.5	0.3	15,800	255	0.15	3	0.15		
		7.5	21,200	375	1.2	6	0.21	15,800	255	0.09	4.5	0.09		
		8	21,200	375	0.9	7.5	0.15	15,800	255	0.06	6	0.06		
		9	21,200	375	0.9	7.5	0.15	15,800	255	0.06	6	0.06		
2040	4	12	21,200	375	0.45	10.5	0.06	15,800	255	0.03	9	0.03		
		6	15,800	405	2	6	0.4	11,900	275	0.2	4	0.2		
		8	15,800	405	2	6	0.4	11,900	275	0.2	4	0.2		
		10	15,800	405	1.6	8	0.28	11,900	275	0.12	6	0.12		
		11	15,800	405	1.2	10	0.2	11,900	275	0.08	8	0.08		
2050	5	12	15,800	405	1.2	10	0.2	11,900	275	0.08	8	0.08		
		16	15,800	405	0.6	14	0.08	11,900	275	0.04	12	0.04		
		7.5	12,700	385	2.5	7.5	0.5	9,500	280	0.25	5	0.25		
		10	12,700	385	2.5	7.5	0.5	9,500	280	0.25	5	0.25		
		12.5	12,700	385	2	10	0.35	9,500	280	0.15	7.5	0.15		
2060	6	13	12,700	385	1.5	12.5	0.25	9,500	280	0.1	10	0.1		
		15	12,700	385	1.5	12.5	0.25	9,500	280	0.1	10	0.1		
		20	12,700	385	0.75	17.5	0.1	9,500	280	0.05	15	0.05		
		9	10,600	435	3	9	0.6	7,900	290	0.3	6	0.3		
		12	10,600	435	3	9	0.6	7,900	290	0.3	6	0.3		
2080	8	13	10,600	435	2.4	12	0.42	7,900	290	0.18	9	0.18		
		15	10,600	435	2.4	12	0.42	7,900	290	0.18	9	0.18		
		18	10,600	435	1.8	15	0.3	7,900	290	0.12	12	0.12		
		24	10,600	435	0.9	21	0.12	7,900	290	0.06	18	0.06		
		16	7,900	405	4	12	0.8	5,900	245	0.4	8	0.4		
2100	10	19	7,900	405	3.2	16	0.56	5,900	245	0.24	12	0.24		
		20	7,900	405	3.2	16	0.56	5,900	245	0.24	12	0.24		
		24	7,900	405	2.4	20	0.4	5,900	245	0.16	16	0.16		
		32	7,900	405	1.2	28	0.16	5,900	245	0.08	24	0.08		
		20	6,300	415	5	15	1	4,700	245	0.5	10	0.5		
2120	12	22	6,300	415	4	20	0.7	4,700	245	0.3	15	0.3		
		25	6,300	415	4	20	0.7	4,700	245	0.3	15	0.3		
		30	6,300	415	3	25	0.5	4,700	245	0.2	20	0.2		
		24	5,300	400	6	18	1.2	3,900	219	0.6	12	0.6		
		26	5,300	400	4.8	24	0.84	3,900	219	0.36	18	0.36		
2120	12	30	5,300	400	4.8	24	0.84	3,900	219	0.36	18	0.36		
		36	5,300	400	3.6	30	0.6	3,900	219	0.24	24	0.24		
		48	5,300	400	1.8	42	0.24	3,900	219	0.12	36	0.12		

UDC Series

CBN Series

Square

Square

Long Neck Square

Radius

Radius

Long Neck Radius

Taper Neck Radius

Ball / Long Shank Ball

Ball

Long Neck Ball

Taper Neck Ball

Taper

Taper

Spiral V Cutter

Drill

EURO Series

Technical Data

Milling Conditions for C-CES (2 Flutes)

Milling amount for slotting (mm)
 $D < \phi 1$

Length of Cut \ Work Material	2D or below	2.5D or below	3D or below	4D or below
45HRC or below	$a_p=0.1D$	$a_p=0.07D$	$a_p=0.05D$	$a_p=0.02D$
45HRC or above	$a_p=0.02D$	$a_p=0.02D$	$a_p=0.01D$	$a_p=0.01D$

$\phi 1 \leq D < \phi 3$

Length of Cut \ Work Material	2D or below	2.5D or below	3D or below	4D or below
45HRC or below	$a_p=0.25D$	$a_p=0.2D$	$a_p=0.125D$	$a_p=0.075D$
45HRC or above	$a_p=0.05D$	$a_p=0.03D$	$a_p=0.02D$	$a_p=0.01D$

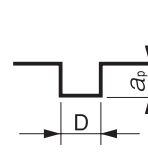

$\phi 3 \leq D$

Length of Cut \ Work Material	2D or below	2.5D or below	3D or below	4D or below
45HRC or below	$a_p=0.5D$	$a_p=0.4D$	$a_p=0.3D$	$a_p=0.15D$
45HRC or above	$a_p=0.05D$	$a_p=0.03D$	$a_p=0.02D$	$a_p=0.01D$

Milling amount for side milling (mm)

Length of Cut \ Work Material	2D or below	2.5D or below	3D or below	4D or below
45HRC or below	$a_p=1.5D$ $a_e=0.1D$	$a_p=2D$ $a_e=0.07D$	$a_p=2.5D$ $a_e=0.05D$	$a_p=3.5D$ $a_e=0.02D$
45HRC or above	$a_p=1D$ $a_e=0.05D$	$a_p=1.5D$ $a_e=0.03D$	$a_p=2D$ $a_e=0.02D$	$a_p=3D$ $a_e=0.01D$

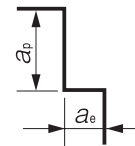

D : Outside Diameter (mm)

Ex.) 2D or below : Flute Length = Diameter × 2 or below

a_p : Axial Depth (mm)

a_e : Radial Depth (mm)

Note:

- Recommend water soluble or oil coolant.
- Recommend oil coolant for Titanium Alloys and Heat Resistant Alloys.

UDC Series

CBN Series

Square

Long Neck Square

Radius

Long Neck Radius

Taper Neck Radius

Ball / Long Shark Ball

Long Neck Ball

Taper Neck Ball

Taper

Spiral V Cutter

Drill

EURO Series

Technical Data

UDC Series

CBN Series

Square

Square

Long Neck Square

Radius

Radius

Long Neck Radius

Taper Neck Radius

Ball

Ball / Long Shank Ball

Long Neck Ball

Taper Neck Ball

Taper

Taper

Spiral V Cutter

Drill

EURO Series

Technical Data



Size $\phi 0.2 \sim \phi 12$

C-CES2000S



Material Applications (☆ Highly Recommended ○ Recommended ○ Suggested)

Work Material															
Carbon Steels S45C S55C	Alloy Steels SK / SCM SUS	Prehardened Steels NAK HPM	Hardened Steels			Cast Iron	Aluminum Alloys	Graphite	Copper	Plastics	Glass Filled Plastics	Titanium Alloys	Heat Resistant Alloys	Cemented Carbide	Hard Brittle (Non-Metallic) Materials
			~55HRC	~60HRC	~70HRC										
○	○	○	○			○			○			○	○		

Features

2 flute C-CES with a sharp corner design.

Broad application range from Copper and Carbon Steels up to Hardened Steels (55HRC).

Excellent performance/quality to price ratio.

Refer to page 214 for 4 flute C-CES-S.

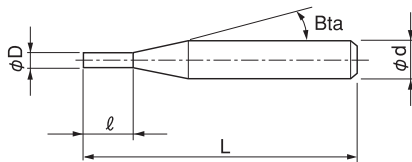

The shank taper angle shown is not an exact value and to avoid contact with the work piece, we recommend the user controls the precise value of this angle. Shank taper angle should not make contact with the work piece.

Total 35 models

Unit (mm)

Model Number	Outside Diameter ϕD	Length of Cut ℓ	Shank Taper Angle Bta	Overall Length L	Shank Diameter ϕd	Price \yen
C-CES 2002-0030S	0.2	0.3	16°	45	4	4,680
C-CES 2002-0060S		0.6		45		
C-CES 2003-0045S	0.3	0.45	16°	45	4	4,080
C-CES 2003-0090S		0.9		45		
C-CES 2004-0060S	0.4	0.6	16°	45	4	4,560
C-CES 2004-0120S		1.2		45		
C-CES 2005-0075S	0.5	0.75	16°	45	4	2,280
C-CES 2005-0150S		1.5		45		
C-CES 2006-0090S	0.6	0.9	16°	45	4	3,480
C-CES 2007-0105S	0.7	1.05	16°	45	4	3,840
C-CES 2008-0120S	0.8	1.2	16°	45	4	2,280
C-CES 2008-0240S		2.4		45		
C-CES 2009-0135S	0.9	1.35	16°	45	4	3,840
C-CES 2010-0150S	1	1.5	16°	45	4	2,040
C-CES 2010-0300S		3		45		
C-CES 2012-0180S	1.2	1.8	16°	45	4	2,280
C-CES 2012-0360S		3.6		45		

Next Page ➡

Unit (mm)

Model Number	Outside Diameter ϕD	Length of Cut ℓ	Shank Taper Angle Bta	Overall Length L	Shank Diameter ϕd	Price ¥
C-CES 2015-0225S	1.5	2.25	16°	45	4	2,040
C-CES 2015-0450S		4.5		45		
C-CES 2018-0270S	1.8	2.7	16°	45	4	2,280
C-CES 2018-0540S		5.4		45		
C-CES 2020-0300S	2	3	16°	45	4	2,040
C-CES 2020-0600S		6		45		
C-CES 2025-0375S	2.5	3.75	16°	45	4	2,040
C-CES 2030-0450S	3	4.5	16°	45	6	2,640
C-CES 2030-0900S		9		45		
C-CES 2040-0600S	4	6	16°	50	6	2,880
C-CES 2040-1200S		12		50		
C-CES 2050-0750S	5	7.5	16°	50	6	3,120
C-CES 2050-1500S		15		50		
C-CES 2060-0900S	6	9	—	50	6	3,360
C-CES 2060-1800S		18		50		
C-CES 2080-2400S	8	24	—	80	8	6,320
C-CES 2100-3000S	10	30	—	80	10	7,580
C-CES 2120-3600S	12	36	—	90	12	11,170

UDC Series

CBN Series

Square
Long Neck
Square

Radius

Radius
Long Neck
RadiusTaper Neck
RadiusBall / Long
Shank BallBall
Long Neck
BallTaper Neck
BallTaper
TaperSpiral
V Cutter

Drill

EURO Series

Technical Data

Milling Conditions for C-CES-S (2 Flutes)

WORK MATERIAL			CARBON STEELS S45C / S50C (~225HB)					ALLOY STEELS SK / SCM / SUS (225~325HB)				
Model Number	Outside Diameter (mm)	Length of Cut (mm)	Spindle Speed (min ⁻¹)	Feed Rate (mm/min)	Slotting	Side Milling		Spindle Speed (min ⁻¹)	Feed Rate (mm/min)	Slotting	Side Milling	
					a _p (mm)	a _p (mm)	a _e (mm)			a _p (mm)	a _p (mm)	a _e (mm)
2002	0.2	0.3	27,000	60	0.02	0.3	0.02	27,000	60	0.02	0.3	0.02
		0.6	27,000	60	0.01	0.5	0.01	27,000	60	0.01	0.5	0.01
2003	0.3	0.45	27,000	77	0.03	0.45	0.03	27,000	77	0.03	0.45	0.03
		0.9	27,000	77	0.015	0.75	0.015	27,000	77	0.015	0.75	0.015
2004	0.4	0.6	27,000	84	0.04	0.6	0.04	27,000	84	0.04	0.6	0.04
		1.2	27,000	84	0.02	1	0.02	27,000	84	0.02	1	0.02
2005	0.5	0.75	27,000	84	0.05	0.75	0.05	26,100	84	0.05	0.75	0.05
		1.5	27,000	84	0.025	1.25	0.025	26,100	84	0.025	1.25	0.025
2006	0.6	0.9	27,000	84	0.06	0.9	0.06	21,600	84	0.06	0.9	0.06
2007	0.7	1.05	24,750	84	0.07	1.05	0.07	18,900	84	0.07	1.05	0.07
2008	0.8	1.2	21,600	84	0.08	1.2	0.08	17,100	84	0.08	1.2	0.08
		2.4	21,600	84	0.04	2	0.04	17,100	84	0.04	2	0.04
2009	0.9	1.35	19,350	88	0.09	1.35	0.09	14,850	84	0.09	1.35	0.09
2010	1	1.5	18,000	88	0.25	1.5	0.1	13,500	84	0.25	1.5	0.1
		3	18,000	88	0.125	2.5	0.05	13,500	84	0.125	2.5	0.05
2012	1.2	1.8	15,030	91	0.3	1.8	0.12	11,250	84	0.3	1.8	0.12
		3.6	15,030	91	0.15	3	0.06	11,250	84	0.15	3	0.06
2015	1.5	2.25	12,150	91	0.375	2.25	0.15	9,000	84	0.375	2.25	0.15
		4.5	12,150	91	0.1875	3.75	0.075	9,000	84	0.1875	3.75	0.075
2018	1.8	2.7	10,350	91	0.45	2.7	0.18	7,920	84	0.45	2.7	0.18
		5.4	10,350	91	0.225	4.5	0.09	7,920	84	0.225	4.5	0.09
2020	2	3	9,900	91	0.5	3	0.2	7,650	84	0.5	3	0.2
		6	9,900	91	0.25	5	0.1	7,650	84	0.25	5	0.1
2025	2.5	3.75	7,920	137	0.625	3.75	0.25	6,300	95	0.625	3.75	0.25
2030	3	4.5	6,660	137	1.5	4.5	0.3	5,760	102	1.5	4.5	0.3
		9	6,660	137	0.9	7.5	0.15	5,760	102	0.9	7.5	0.15
2040	4	6	5,310	161	2	6	0.4	4,500	133	2	6	0.4
		12	5,310	161	1.2	10	0.2	4,500	133	1.2	10	0.2
2050	5	7.5	4,770	217	2.5	7.5	0.5	3,780	161	2.5	7.5	0.5
		15	4,770	217	1.5	12.5	0.25	3,780	161	1.5	12.5	0.25
2060	6	9	3,960	214	3	9	0.6	3,150	161	3	9	0.6
		18	3,960	214	1.8	15	0.3	3,150	161	1.8	15	0.3
2080	8	24	2,970	203	2.4	20	0.4	2,340	161	2.4	20	0.4
2100	10	30	2,340	193	3	25	0.5	1,890	158	3	25	0.5
2120	12	36	1,980	193	3.6	30	0.6	1,575	158	3.6	30	0.6

UDC Series

CBN Series

Square
Long Neck Square

Radius
Long Neck Radius
Taper Neck Radius

Ball / Long Shank Ball
Long Neck Ball
Taper Neck Ball

Taper

Spiral V Cutter

Drill

EURO Series

Technical Data

Milling Conditions for C-CES-S (2 Flutes)

WORK MATERIAL			PREHARDENED STEELS HARDENED STEELS NAK / SKD (30~45HRC)					HARDENED STEELS SKD / SKT (45~55HRC)				
Model Number	Outside Diameter (mm)	Length of Cut (mm)	Spindle Speed (min ⁻¹)	Feed Rate (mm/min)	Slotting	Side Milling		Spindle Speed (min ⁻¹)	Feed Rate (mm/min)	Slotting	Side Milling	
					a _p (mm)	a _p (mm)	a _e (mm)			a _p (mm)	a _p (mm)	a _e (mm)
2002	0.2	0.3	24,000	21	0.02	0.3	0.02	24,000	18	0.004	0.2	0.01
		0.6	24,000	21	0.01	0.5	0.01	24,000	18	0.002	0.4	0.004
2003	0.3	0.45	24,000	39	0.03	0.45	0.03	17,600	18	0.006	0.3	0.015
		0.9	24,000	39	0.015	0.75	0.015	17,600	18	0.003	0.6	0.006
2004	0.4	0.6	21,600	42	0.04	0.6	0.04	13,600	18	0.008	0.4	0.02
		1.2	21,600	42	0.02	1	0.02	13,600	18	0.004	0.8	0.008
2005	0.5	0.75	17,200	42	0.05	0.75	0.05	10,400	18	0.01	0.5	0.025
		1.5	17,200	42	0.025	1.25	0.025	10,400	18	0.005	1	0.01
2006	0.6	0.9	14,400	42	0.06	0.9	0.06	8,800	18	0.012	0.6	0.03
2007	0.7	1.05	12,400	42	0.07	1.05	0.07	8,000	18	0.014	0.7	0.035
2008	0.8	1.2	11,040	42	0.08	1.2	0.08	7,040	21	0.016	0.8	0.04
		2.4	11,040	42	0.04	2	0.04	7,040	21	0.008	1.6	0.016
2009	0.9	1.35	9,600	46	0.09	1.35	0.09	6,240	21	0.018	0.9	0.045
2010	1	1.5	8,800	46	0.25	1.5	0.1	5,680	21	0.05	1	0.05
		3	8,800	46	0.125	2.5	0.05	5,680	21	0.02	2	0.02
2012	1.2	1.8	7,520	46	0.3	1.8	0.12	4,800	21	0.06	1.2	0.06
		3.6	7,520	46	0.15	3	0.06	4,800	21	0.024	2.4	0.024
2015	1.5	2.25	6,400	49	0.375	2.25	0.15	4,080	25	0.075	1.5	0.075
		4.5	6,400	49	0.1875	3.75	0.075	4,080	25	0.03	3	0.03
2018	1.8	2.7	5,600	49	0.45	2.7	0.18	3,520	25	0.09	1.8	0.09
		5.4	5,600	49	0.225	4.5	0.09	3,520	25	0.036	3.6	0.036
2020	2	3	5,120	49	0.5	3	0.2	3,200	28	0.1	2	0.1
		6	5,120	49	0.25	5	0.1	3,200	28	0.04	4	0.04
2025	2.5	3.75	4,000	49	0.625	3.75	0.25	2,560	28	0.125	2.5	0.125
2030	3	4.5	3,600	56	1.5	4.5	0.3	2,240	32	0.15	3	0.15
		9	3,600	56	0.9	7.5	0.15	2,240	32	0.06	6	0.06
2040	4	6	2,800	63	2	6	0.4	1,720	35	0.2	4	0.2
		12	2,800	63	1.2	10	0.2	1,720	35	0.08	8	0.08
2050	5	7.5	2,360	63	2.5	7.5	0.5	1,480	39	0.25	5	0.25
		15	2,360	63	1.5	12.5	0.25	1,480	39	0.1	10	0.1
2060	6	9	1,960	70	3	9	0.6	1,200	39	0.3	6	0.3
		18	1,960	70	1.8	15	0.3	1,200	39	0.12	12	0.12
2080	8	24	1,480	67	2.4	20	0.4	960	35	0.16	16	0.16
2100	10	30	1,160	67	3	25	0.5	760	35	0.2	20	0.2
2120	12	36	960	63	3.6	30	0.6	640	32	0.24	24	0.24

UDC Series

CBN Series

Square
Long Neck Square

Radius

Radius
Long Neck Radius

Taper Neck Radius

Ball / Long Shank Ball

Ball
Long Neck Ball

Taper Neck Ball

Taper
Taper

Spiral V Cutter

Drill

EURO Series

Technical Data

Milling Conditions for C-CES-S (2 Flutes)

Milling amount for slotting (mm)
 $D < \phi 1$

Work Material	Length of Cut	
	2D or below	3D or below
45HRC or below	$a_p = 0.1D$	$a_p = 0.05D$
45HRC or above	$a_p = 0.02D$	$a_p = 0.01D$

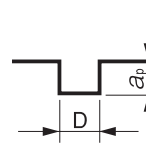

$\phi 1 \leq D < \phi 3$

Work Material	Length of Cut	
	2D or below	3D or below
45HRC or below	$a_p = 0.25D$	$a_p = 0.125D$
45HRC or above	$a_p = 0.05D$	$a_p = 0.02D$

$\phi 3 \leq D$

Work Material	Length of Cut	
	2D or below	3D or below
45HRC or below	$a_p = 0.5D$	$a_p = 0.3D$
45HRC or above	$a_p = 0.05D$	$a_p = 0.02D$

Milling amount for side milling (mm)

Work Material	Length of Cut	
	2D or below	3D or below
45HRC or below	$a_p = 1.5D$ $a_e = 0.1D$	$a_p = 2.5D$ $a_e = 0.05D$
45HRC or above	$a_p = 1D$ $a_e = 0.05D$	$a_p = 2D$ $a_e = 0.02D$

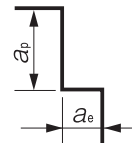

D : Outside Diameter (mm)

Ex.) 2D or below : Flute Length = Diameter \times 2 or below

a_p : Axial Depth (mm)

a_e : Radial Depth (mm)

Note:

- Recommend water soluble or oil coolant.
- Recommend oil coolant for Titanium Alloys and Heat Resistant Alloys.

UDC Series

CBN Series

Square

Long Neck Square

Radius

Long Neck Radius

Taper Neck Radius

Ball / Long Shark Ball

Long Neck Ball

Taper Neck Ball

Taper

Spiral V Cutter

Drill

EURO Series

Technical Data

UDC Series

CBN Series

Square

Long Neck Square

Radius

Long Neck Radius

Taper Neck Radius

Ball / Long Shank Ball

Long Neck Ball

Taper Neck Ball

Taper

Spiral V Cutter

Drill

EURO Series

Technical Data

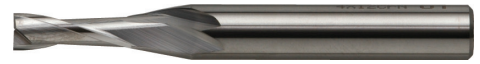

Size $\phi 0.2 \sim \phi 12$

CRN-ES2000



Material Applications (☆ Highly Recommended ● Recommended ○ Suggested)

Work Material															
Carbon Steels	Alloy Steels	Prehardened Steels	Hardened Steels			Cast Iron	Aluminum Alloys	Graphite	Copper	Plastics	Glass Filled Plastics	Titanium Alloys	Heat Resistant Alloys	Cemented Carbide	Hard Brittle (Non-Metallic) Materials
			~55HRC	~60HRC	~70HRC										
S45C S55C	SK / SCM SUS	NAK HPM							☆	○					

Features

CrN COAT offers longer tool life.
 Special geometry designed for Copper offers excellent milling performance.
 Refer to page 220 for 4 flute CRN-ES.
 Diameter Tolerance: 0/-0.02 (D ≤ 6), 0/-0.03 (D ≥ 8)

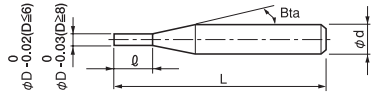

The shank taper angle shown is not an exact value and to avoid contact with the work piece, we recommend the user controls the precise value of this angle. Shank taper angle should not make contact with the work piece.

Total 26 models

Unit (mm)

Model Number	Outside Diameter ϕD	Length of Cut ℓ	Shank Taper Angle Bta	Overall Length L	Shank Diameter ϕd	Price ¥
CRN-ES 2002-0060	0.2	0.6	11°	40	4	6,100
CRN-ES 2003-0090	0.3	0.9	11°	40	4	6,100
CRN-ES 2004-0120	0.4	1.2	11°	40	4	6,100
CRN-ES 2005-0150	0.5	1.5	11°	40	4	3,200
CRN-ES 2005-0200		2		45	4	5,500
CRN-ES 2006-0180	0.6	1.8	11°	40	4	5,060
CRN-ES 2006-0240		2.4		45	4	5,500
CRN-ES 2008-0240	0.8	2.4	11°	40	4	3,200
CRN-ES 2010-0300	1	3	11°	45	4	3,200
CRN-ES 2010-0400		4		50	4	4,950
CRN-ES 2015-0450	1.5	4.5	11°	45	4	3,200
CRN-ES 2015-0600		6		50	4	4,950
CRN-ES 2020-0600	2	6	11°	45	4	3,200
CRN-ES 2020-0800		8		50	4	4,950
CRN-ES 2025-0750	2.5	7.5	11°	45	4	3,200
CRN-ES 2030-0900	3	9	11°	50	6	3,740
CRN-ES 2030-1200		12		55	6	6,050
CRN-ES 2040-1200	4	12	11°	50	6	3,960
CRN-ES 2040-1600		16		55	6	6,600
CRN-ES 2050-1500	5	15	11°	55	6	4,200
CRN-ES 2060-1800	6	18	—	60	6	4,620
CRN-ES 2060-2400		24		65	6	7,480
CRN-ES 2080-2400	8	24	—	80	8	8,760
CRN-ES 2100-3000	10	30	—	100	10	10,900
CRN-ES 2100-4000		40		100	10	17,280
CRN-ES 2120-3600	12	36	—	100	12	15,000

Milling Conditions for CRN-ES (2 Flutes)

◆3D flute length type

WORK MATERIAL		COPPER C1100						
		Side Milling				Slotting		
Model Number	Outside Diameter (mm)	Spindle Speed (min ⁻¹)	Feed Rate (mm/min)	a_p Axial Depth (mm)	a_e Radial Depth (mm)	Spindle Speed (min ⁻¹)	Feed Rate (mm/min)	a_p Axial Depth (mm)
2002-0060	0.2	40,000	100	0.3	0.004	40,000	85	0.01
2003-0090	0.3	38,000	100	0.45	0.006	38,000	85	0.015
2004-0120	0.4	35,000	100	0.6	0.008	35,000	85	0.02
2005-0150	0.5	32,000	120	0.75	0.01	32,000	100	0.025
2006-0180	0.6	29,000	150	0.9	0.012	26,000	120	0.03
2008-0240	0.8	22,000	180	1.2	0.016	21,000	150	0.04
2010-0300	1	18,000	180	1.5	0.02	16,000	150	0.05
2015-0450	1.5	17,500	250	2.25	0.15	11,000	150	0.15
2020-0600	2	17,000	340	3	0.2	7,500	150	0.2
2025-0750	2.5	16,500	450	3.75	0.25	6,000	150	0.25
2030-0900	3	16,000	630	4.5	0.3	5,000	170	0.3
2040-1200	4	12,000	650	6	0.4	5,000	200	0.4
2050-1500	5	10,000	750	7.5	0.5	5,000	250	0.5
2060-1800	6	8,000	800	9	0.6	4,500	250	0.6
2080-2400	8	6,000	700	12	0.8	4,000	250	0.8
2100-3000	10	5,000	600	15	1	4,000	350	1
2120-3600	12	4,000	500	18	1.2	4,000	450	1.2

◆4D flute length type

WORK MATERIAL		COPPER C1100						
		Side Milling				Slotting		
Model Number	Outside Diameter (mm)	Spindle Speed (min ⁻¹)	Feed Rate (mm/min)	a_p Axial Depth (mm)	a_e Radial Depth (mm)	Spindle Speed (min ⁻¹)	Feed Rate (mm/min)	a_p Axial Depth (mm)
2005-0200	0.5	16,000	60	1.25	0.005	16,000	50	0.025
2006-0240	0.6	14,500	75	1.5	0.006	14,500	65	0.03
2010-0400	1	9,000	90	2.5	0.01	8,000	75	0.05
2015-0600	1.5	9,000	150	3.75	0.075	8,000	130	0.15
2020-0800	2	5,000	140	5	0.1	4,500	120	0.2
2030-1200	3	3,500	140	7.5	0.15	2,500	85	0.3
2040-1600	4	3,500	200	10	0.2	2,500	100	0.4
2060-2400	6	3,000	200	15	0.3	2,500	150	0.6
2100-4000	10	2,500	230	25	0.5	2,000	175	1

Milling	Length of Cut	
	3D Flute Length Type	4D Flute Length Type
Side Milling	a_p 1.5D a_e 0.02D ($D \leq \phi 1.0$) a_e 0.1D ($D > \phi 1.0$)	a_p 2.5D a_e 0.01D ($D \leq \phi 1.0$) a_e 0.05D ($D > \phi 1.0$)
Slotting	a_p 0.05D ($D \leq \phi 1.0$) a_p 0.1D ($D > \phi 1.0$)	a_p 0.05D ($D \leq \phi 1.0$) a_p 0.1D ($D > \phi 1.0$)

Note:

- Decrease both spindle speed and feed rate proportionally in case of chattering.
- Adjust the milling amount and feed rate in accordance with required precision.
- Recommend water soluble or oil coolant.
- Recommended for Pure Copper. Not suitable for Tungsten Copper.

Side Milling

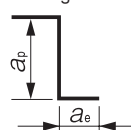

a_p : Axial Depth (mm)
 a_e : Radial Depth (mm)
 D : Outside Diameter (mm)

Slotting

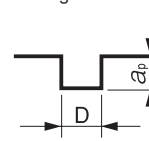

UDC Series

CBN Series

Square

Long Neck Square

Radius

Long Neck Radius

Taper Neck Radius

Ball / Long Shank Ball

Long Neck Ball

Taper Neck Ball

Taper

Spiral V Cutter

Drill

EURO Series

Technical Data



Size $\phi 0.2 \sim \phi 6$

DCES2000



Material Applications (☆ Highly Recommended ● Recommended ○ Suggested)

Work Material															
Carbon Steels S45C S55C	Alloy Steels SK / SCM SUS	Prehardened Steels NAK HPM	Hardened Steels			Cast Iron	Aluminum Alloys	Graphite	Copper	Plastics	Glass Filled Plastics	Titanium Alloys	Heat Resistant Alloys	Cemented Carbide	Hard Brittle (Non-Metallic) Materials
			~55HRC	~60HRC	~70HRC										
							○	☆	○	○	●				○

Features

Diamond coated 2 Flute Square End Mills for Graphite Electrodes.

New Diamond coating, with a highly adhesive base layer, offers excellent wear resistance and longer tool life. Refer to page 222 for 4 flute DCES.

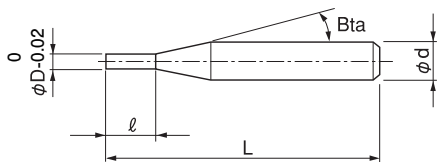

The shank taper angle shown is not an exact value and to avoid contact with the work piece, we recommend the user controls the precise value of this angle. Shank taper angle should not make contact with the work piece.

Total 8 models

Unit (mm)

Model Number	Outside Diameter ϕD	Length of Cut ℓ	Shank Taper Angle Bta	Overall Length L	Shank Diameter ϕd	Price ¥
DCES 2002-0060	0.2	0.6	16°	45	4	17,000
DCES 2005-0150	0.5	1.5	16°	45	4	14,500
DCES 2010-0300	1	3	16°	45	4	14,500
DCES 2015-0450	1.5	4.5	16°	45	4	14,500
DCES 2020-0600	2	6	16°	45	4	14,500
DCES 2030-0900	3	9	16°	45	6	17,000
DCES 2040-1200	4	12	16°	50	6	18,100
DCES 2060-1800	6	18	—	60	6	19,300

Milling Conditions for DCES (2 Flutes)

WORK MATERIAL			GRAPHITE				
Model Number	Outside Diameter (mm)	Length of Cut (mm)	Spindle Speed (min ⁻¹)	Feed Rate (mm/min)	Side Milling		Slotting
					a_p Axial Depth (mm)	a_e Radial Depth (mm)	a_p Axial Depth (mm)
2002-0060	0.2	0.6	30,000	1,000	0.6	0.01	0.006
2005-0150	0.5	1.5	30,000	1,100	1.5	0.025	0.02
2010-0300	1	3	28,000	1,300	3	0.05	0.05
2015-0450	1.5	4.5	25,000	1,500	4.5	0.075	0.12
2020-0600	2	6	24,000	1,800	6	0.1	0.15
2030-0900	3	9	25,000	2,600	9	0.15	0.3
2040-1200	4	12	19,000	2,000	12	0.24	0.6
2060-1800	6	18	13,000	1,500	18	0.36	1.2

Slotting

a_p : Axial Depth (mm)
D : Outside Diameter (mm)

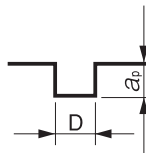

Side Milling

a_p : Axial Depth (mm)
 a_e : Radial Depth (mm)

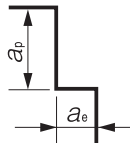

Note:

- Use a milling machine dedicated for Graphite.
- Recommend air blow for Graphite.

UDC Series

CBN Series

Square

Long Neck Square

Radius

Long Neck Radius

Taper Neck Radius

Ball / Long Shank Ball

Long Neck Ball

Taper Neck Ball

Taper

Spiral V Cutter

Drill

EURO Series

Technical Data



Size $\phi 0.3 \sim \phi 12$

CPS



Material Applications (☆ Highly Recommended ◎ Recommended ○ Suggested)

Work Material															
Carbon Steels S45C S55C	Alloy Steels SK / SCM SUS	Prehardened Steels NAK HPM	Hardened Steels			Cast Iron	Aluminum Alloys	Graphite	Copper	Plastics	Glass Filled Plastics	Titanium Alloys	Heat Resistant Alloys	Cemented Carbide	Hard Brittle (Non-Metallic) Materials
			~55HRC	~60HRC	~70HRC										
							○		◎	☆					

Features

Medium length of cut design for Plastic milling.
 Original flute design offers excellent surface finish.
 Length of cut = outside diameter x3 (Note: outside diameter x1.5~2 is partially included).
 Provides excellent milling surface for long overhang milling on Plastics.

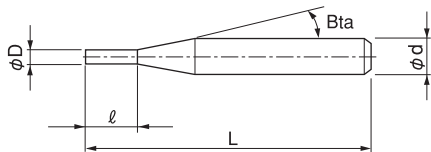

The shank taper angle shown is not an exact value and to avoid contact with the work piece, we recommend the user controls the precise value of this angle. Shank taper angle should not make contact with the work piece.

Total 23 models

Unit (mm)

Model Number	Outside Diameter ϕD	Length of Cut ℓ	Shank Taper Angle Bta	Overall Length L	Shank Diameter ϕd	Price \yen
◎ CPS 2003	0.3	0.9	16°	45	4	6,480
◎ CPS 2004	0.4	1.2	16°	45	4	7,080
◎ CPS 2005	0.5	1.5	16°	45	4	4,800
◎ CPS 2006	0.6	1.8	16°	45	4	5,520
◎ CPS 2007	0.7	2.1	16°	45	4	6,000
◎ CPS 2008	0.8	2.4	16°	45	4	5,520
◎ CPS 2009	0.9	2.7	16°	45	4	6,000
◎ CPS 2010	1	3	16°	50	4	3,840
◎ CPS 2012	1.2	3.6	16°	50	4	4,200
◎ CPS 2015	1.5	4.5	16°	50	4	4,200
◎ CPS 2020	2	6	16°	55	4	4,200
◎ CPS 2025	2.5	7.5	16°	55	4	4,300
◎ CPS 2030		9	16°	60	6	5,400
◎ CPS 2030SS	3	4.5	—	60	3	5,200
◎ CPS 2030SSL		6	—	100	3	7,800
◎ CPS 2040		12	16°	60	6	5,400
◎ CPS 2040SS	4	6	—	60	4	5,200
◎ CPS 2040SSL		8	—	100	4	9,600
◎ CPS 2050	5	15	16°	60	6	6,240
◎ CPS 2060	6	18	—	60	6	6,600
◎ CPS 2080	8	24	—	80	8	12,100
◎ CPS 2100	10	30	—	80	10	14,850
◎ CPS 2120	12	36	—	90	12	22,000

◎ Straight shank type

Milling Conditions for CPS

WORK MATERIAL			ABS / MC NYLON			ACRYLIC / POLYACETAL			POLYCARBONATE			GLASS FIBER REINFORCED POLYCARBONATE		
Model Number	Outside Diameter (mm)	Length of Cut (mm)	Spindle Speed (min ⁻¹)	Feed Rate (mm/min)	a_p Axial Depth (mm)	Spindle Speed (min ⁻¹)	Feed Rate (mm/min)	a_p Axial Depth (mm)	Spindle Speed (min ⁻¹)	Feed Rate (mm/min)	a_p Axial Depth (mm)	Spindle Speed (min ⁻¹)	Feed Rate (mm/min)	a_p Axial Depth (mm)
2003	0.3	0.9	20,000	320	0.3	16,000	160	0.3	16,000	130	0.2	16,000	260	0.2
2004	0.4	1.2	20,000	400	0.4	16,000	160	0.4	16,000	130	0.2	16,000	260	0.3
2005	0.5	1.5	20,000	480	0.5	16,000	160	0.5	16,000	130	0.3	16,000	320	0.4
2006	0.6	1.8	20,000	600	0.6	16,000	200	0.5	16,000	130	0.3	16,000	390	0.5
2007	0.7	2.1	20,000	720	0.7	16,000	260	0.6	16,000	160	0.4	16,000	390	0.6
2008	0.8	2.4	20,000	800	0.8	16,000	320	0.7	16,000	160	0.4	15,200	430	0.6
2009	0.9	2.7	20,000	880	0.9	14,200	340	0.8	14,200	170	0.5	14,200	460	0.7
2010	1	3	20,000	1,000	1	14,100	430	0.9	14,100	290	0.5	14,100	510	0.8
2012	1.2	3.6	20,000	1,080	1.2	14,100	480	1.1	14,100	340	0.6	14,100	650	1
2015	1.5	4.5	20,000	1,160	1.5	12,800	460	1.4	12,800	390	0.8	13,200	740	1.2
2020	2	6	20,000	1,200	2	12,800	510	1.6	12,500	430	0.6	13,100	740	1.4
2025	2.5	7.5	20,000	1,200	2.5	12,800	570	2	10,200	450	0.8	12,700	760	1.8
2030	3	9	20,000	1,200	3	12,800	640	2.4	9,600	430	0.9	10,700	810	2.1
2030SS	3	4.5	20,000	1,200	3	12,800	640	2.4	9,600	430	0.9	10,700	810	2.1
2030SSL	3	6	20,000	1,200	3	12,800	640	2.4	9,600	430	0.9	10,700	810	2.1
2040	4	12	14,900	1,200	4	12,000	600	3.2	8,000	400	1.2	8,000	770	2.8
2040SS	4	6	14,900	1,200	4	12,000	600	3.2	8,000	400	1.2	8,000	770	2.8
2040SSL	4	8	14,900	1,200	4	12,000	600	3.2	8,000	400	1.2	8,000	770	2.8
2050	5	15	12,000	960	5	9,600	480	4	6,400	320	1.5	6,400	620	3.5
2060	6	18	10,000	800	6	8,000	400	4.8	5,400	270	1.8	5,400	510	4.2
2080	8	24	7,500	600	8	6,000	300	6.4	4,000	200	2.4	4,000	390	5.6
2100	10	30	6,000	480	10	4,800	240	8	3,200	160	3	3,200	310	7
2120	12	36	5,000	400	12	4,000	200	9.6	2,700	140	3.6	2,700	260	8.4

Milling Amount for Slotting (mm)

 a_p : Axial Depth (mm)

D : Outside Diameter (mm)

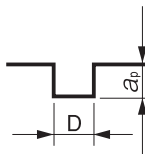

CPS finishing conditions for side milling

Refer to the slotting parameters for spindle speed and feed rate.
Set the milling amount as below during side milling finishing.

Milling Amount for Side Finishing (mm)

 a_p : Axial Depth (mm) a_e : Radial Depth (mm) a_e : 0.01 ~ 0.015D (Min 0.01 mm)

D : Outside Diameter (mm)

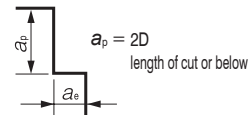

Note:

- Control the radial depth (a_e) by approximately 0.01-0.015 times of the outside diameter or set to 0.01 mm the minimum during side milling finishing.
- Increase the feed rate per flute to reduce burring on surface of softer materials.
- Chattering may occur when using a spindle with low rigidity or when milling unstable work piece. Reduce the milling amount in this case.
- Recommend to reduce the milling amount when using a machine with low spindle speed. Not recommend to reduce the feed rate.
- Adjust the milling parameters based on the overhang length.
- Recommend water soluble coolant for Aluminum Alloys and Copper.
- Recommend air blow for Plastics.
- Remove chips from the work piece to keep the milling surface quality.
- If chips clog on the tool, stop the operation and remove them accordingly.
- Straight shank type (2030SS, 2030SSL, 2040SS, 2040SSL, etc.) has smaller outside diameter than shank diameter. Prevent the shank making contact with the work piece.

UDC Series

CBN Series

Square

Long Neck Square

Radius

Long Neck Radius

Taper Neck Radius

Ball / Long Shank Ball

Ball

Long Neck Ball

Taper Neck Ball

Taper

Spiral V Cutter

Drill

EURO Series

Technical Data



Size $\phi 0.5 \sim \phi 12$

CAS



Material Applications (☆ Highly Recommended ● Recommended ○ Suggested)

Work Material															
Carbon Steels	Alloy Steels	Prehardened Steels	Hardened Steels			Cast Iron	Aluminum Alloys	Graphite	Copper	Plastics	Glass Filled Plastics	Titanium Alloys	Heat Resistant Alloys	Cemented Carbide	Hard Brittle (Non-Metallic) Materials
S45C	SK / SCM	NAK	~55HRC	~60HRC	~70HRC										
S55C	SUS	HPM													
							☆		○						

Features

Designed especially for Aluminum milling.

45° helix angle design offers excellent cutting performance and outstanding chip evacuation.

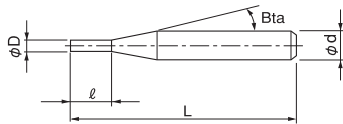

The shank taper angle shown is not an exact value and to avoid contact with the work piece, we recommend the user controls the precise value of this angle. Shank taper angle should not make contact with the work piece.

Total 19 models

Unit (mm)

Model Number	Outside Diameter ϕD	Length of Cut ℓ	Shank Taper Angle B_{ta}	Overall Length L	Shank Diameter ϕd	Price \yen
CAS 2005-0075	0.5	0.75	16°	45	4	4,030
CAS 2010-0150	1	1.5	16°	45	4	3,480
CAS 2015-0225	1.5	2.25	16°	45	4	3,480
CAS 2020-0300	2	3	16°	45	4	3,480
CAS 2025-0375	2.5	3.75	16°	50	6	4,560
CAS 2030-0450	3	4.5	16°	50	6	4,560
CAS 2030-0900		9		50		6,300
CAS 2040-0600	4	6	16°	50	6	4,680
CAS 2040-1200		12		50		6,510
CAS 2050-0750	5	7.5	16°	50	6	5,160
CAS 2050-1500		15		50		7,440
CAS 2060-0900	6	9	—	50	6	5,400
CAS 2060-1500		15		50		7,560
CAS 2080-1200	8	12	—	80	8	7,680
CAS 2080-2000		20		80		10,440
CAS 2100-1500	10	15	—	80	10	10,080
CAS 2100-2500		25		80		13,200
CAS 2120-1800	12	18	—	90	12	14,640
CAS 2120-3000		30		90		18,600

Milling Conditions for CAS

◆ Slotting

WORK MATERIAL		ALUMINUM ALLOYS etc. A5052 etc.			
Model Number	Outside Diameter (mm)	Spindle Speed (min ⁻¹)	Feed Rate (mm/min)	a_p Axial Depth (mm)	
2005-0075	0.5	25,000	250	0.75	
2010-0150	1	25,000	500	1.5	
2015-0225	1.5	25,000	750	2.25	
2020-0300	2	22,000	880	3	
2025-0375	2.5	19,000	950	3.75	
2030-0450	3	16,000	1,600	1.5	
2040-0600	4	12,000	1,200	2	
2050-0750	5	9,600	1,920	2.5	
2060-0900	6	8,000	1,600	3	
2080-1200	8	6,000	1,200	4	
2100-1500	10	12,000	2,400	5	
2120-1800	12	10,000	2,000	6	
Milling Amount (mm)		$D \leq 2.5$ $D \geq 3$	$a_p = 1.5D$ $a_p = 0.5D$		

◆ High speed milling

WORK MATERIAL		ALUMINUM ALLOYS etc. A5052 etc.			
Model Number	Outside Diameter (mm)	Spindle Speed (min ⁻¹)	Feed Rate (mm/min)	a_p Axial Depth (mm)	a_e Radial Depth (mm)
2005-0075	0.5	25,000	1,000	0.75	0.1
2010-0150	1	25,000	1,250	1.5	0.2
2015-0225	1.5	25,000	1,500	2.25	0.3
2020-0300	2	22,000	1,760	3	0.4
2025-0375	2.5	19,000	1,900	3.75	0.5
2030-0450	3	20,000	4,000	4.5	0.6
2040-0600	4	18,200	3,640	6	0.8
2050-0750	5	17,000	3,400	7.5	1
2060-0900	6	16,000	3,200	9	1.2
2080-1200	8	14,400	2,880	12	1.6
2100-1500	10	13,200	2,640	15	2
2120-1800	12	12,000	2,400	18	2.4
Milling Amount (mm)			$a_p = 1.5D$ $a_e = 0.2D$		

◆ Side milling

WORK MATERIAL			ALUMINUM ALLOYS etc. A5052 etc.			
Model Number	Outside Diameter (mm)	Length of Cut (mm)	Spindle Speed (min ⁻¹)	Feed Rate (mm/min)	a_p Axial Depth (mm)	a_e Radial Depth (mm)
2005-0075	0.5	0.75	25,000	1,000	0.75	0.15
2010-0150	1	1.5	25,000	1,250	1.5	0.3
2015-0225	1.5	2.25	25,000	1,500	2.25	0.45
2020-0300	2	3	22,000	1,760	3	0.6
2025-0375	2.5	3.75	19,000	1,900	3.75	0.75
2030-0450	3	4.5	16,000	3,200	4.5	0.6
2030-0900		9			4.5	0.6
2040-0600	4	6	12,000	2,400	6	0.8
2040-1200		12			6	0.8
2050-0750	5	7.5	9,600	1,920	7.5	1
2050-1500		15			7.5	1
2060-0900	6	9	8,000	1,600	9	1.2
2060-1500		15			9	1.2
2080-1200	8	12	6,000	1,200	12	1.6
2080-2000		20			12	1.6
2100-1500	10	15	4,800	960	15	2
2100-2500		25			15	2
2120-1800	12	18	4,000	800	18	2.4
2120-3000		30			18	2.4
Milling Amount (mm)			$a_p = 1.5D$ $D \leq 2.5$ $a_e = 0.3D$ $D \geq 3$ $a_e = 0.2D$	Length of Cut 1.5D	Length of Cut 2.5 · 3D	$a_p = 1.5D$ $a_e = 0.2D$

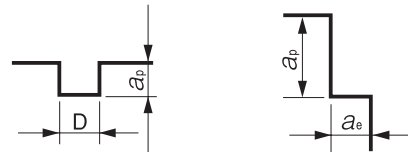

a_p : Axial Depth (mm)
 a_e : Radial Depth (mm)
 D : Outside Diameter (mm)

Note:

- Recommend using a non-contact measuring device to avoid damaging the sharp corner.
- Recommend side milling for finishing.
- Recommend water soluble coolant.

UDC Series
CBN Series
Square
Long Neck Square
Radius
Long Neck Radius
Taper Neck Radius
Ball / Long Shank Ball
Long Neck Ball
Taper Neck Ball
Taper
Spiral V Cutter
Drill
EURO Series
Technical Data

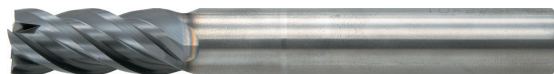

Size $\phi 1 \sim \phi 20$

CZS



Patented in Japan, China, Korea, Taiwan, Germany, Switzerland, Liechtenstein, and Thailand

Material Applications (☆ Highly Recommended ○ Recommended ○ Suggested)

Work Material															
Carbon Steels S45C S55C	Alloy Steels SK / SCM SUS	Prehardened Steels NAK HPM	Hardened Steels			Cast Iron	Aluminum Alloys	Graphite	Copper	Plastics	Glass Filled Plastics	Titanium Alloys	Heat Resistant Alloys	Cemented Carbide	Hard Brittle (Non-Metallic) Materials
			~55HRC	~60HRC	~70HRC										
○	○	○	○			○	○		○			○	○		

Features

The new tip geometry is ideal for vertical milling on horizontal surfaces.
 The selected carbide grade offers excellent resistance to chipping.
 The low friction characteristics of the coating offers excellent chip evacuation and wear resistance.

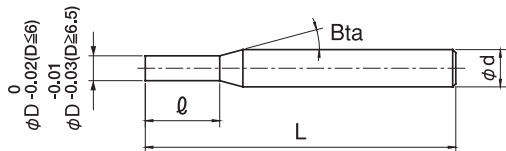

The shank taper angle shown is not an exact value and to avoid contact with the work piece, we recommend the user controls the precise value of this angle. Shank taper angle should not make contact with the work piece. Actual measurement is necessary when using longer length of cut than the written length.

Total 89 models

Unit (mm)

Model Number	Outside Diameter ϕD	Length of Cut ℓ	Shank Taper Angle Bta	Overall Length L	Shank Diameter ϕd	Price \yen
CZS 4010-0150	1	1.5	16°	50	4	6,900
CZS 4010-0250		2.5		50		6,900
CZS 4011-0250	1.1	2.5	16°	50	4	8,630
CZS 4012-0250	1.2	2.5	16°	50	4	8,630
CZS 4013-0300	1.3	3	16°	50	4	8,630
CZS 4014-0300	1.4	3	16°	50	4	8,630
CZS 4015-0225	1.5	2.25	16°	50	4	6,900
CZS 4015-0400		4		50		6,900
CZS 4016-0400	1.6	4	16°	50	4	8,630
CZS 4017-0400	1.7	4	16°	50	4	8,630
CZS 4018-0400	1.8	4	16°	50	4	8,630
CZS 4019-0400	1.9	4	16°	50	4	8,630

Next Page ➡

Unit (mm)

Model Number	Outside Diameter ϕD	Length of Cut ℓ	Shank Taper Angle Bta	Overall Length L	Shank Diameter ϕd	Price ¥
CZS 4020-0300	2	3	16°	50	4	6,300
CZS 4020-0600		6		50		6,300
CZS 4021-0600	2.1	6	16°	50	4	7,870
CZS 4022-0600	2.2	6	16°	50	4	7,870
CZS 4023-0600	2.3	6	16°	50	4	7,870
CZS 4024-0600	2.4	6	16°	50	4	7,870
CZS 4025-0375	2.5	3.75	16°	50	4	6,300
CZS 4025-0800		8		50		6,300
CZS 4026-0800	2.6	8	16°	50	4	7,870
CZS 4027-0800	2.7	8	16°	50	4	7,870
CZS 4028-0800	2.8	8	16°	50	4	7,870
CZS 4029-0800	2.9	8	16°	50	4	7,870
CZS 4030-0450	3	4.5	16°	60	6	7,500
CZS 4030-0800		8		60		7,500
CZS 4031-0800	3.1	8	16°	60	6	9,400
CZS 4032-0800	3.2	8	16°	60	6	9,400
CZS 4033-0800	3.3	8	16°	60	6	9,400
CZS 4034-0800	3.4	8	16°	60	6	9,400
CZS 4035-1000	3.5	10	16°	60	6	8,700
CZS 4036-1000	3.6	10	16°	60	6	9,400
CZS 4037-1000	3.7	10	16°	60	6	9,400
CZS 4038-1000	3.8	10	16°	60	6	9,400
CZS 4039-1000	3.9	10	16°	60	6	9,400
CZS 4040-0600	4	6	16°	60	6	7,800
CZS 4040-1100		11		60		7,800
CZS 4041-1100	4.1	11	16°	60	6	9,750
CZS 4042-1100	4.2	11	16°	60	6	9,750
CZS 4043-1100	4.3	11	16°	60	6	9,750
CZS 4044-1100	4.4	11	16°	60	6	9,750
CZS 4045-1100	4.5	11	16°	60	6	9,300
CZS 4046-1100	4.6	11	16°	60	6	9,750
CZS 4047-1100	4.7	11	16°	60	6	9,750
CZS 4048-1100	4.8	11	16°	60	6	9,750
CZS 4049-1100	4.9	11	16°	60	6	9,750

4 Flutes

UDC Series

CBN Series

Square

Long Neck Square

Radius

Radius

Long Neck Radius

Taper Neck Radius

Ball / Long Shank Ball

Ball

Long Neck Ball

Taper Neck Ball

Taper

Spiral V Cutter

Drill

EURO Series

Technical Data

Next Page ➡

183

Unit (mm)

Model Number	Outside Diameter ϕD	Length of Cut ℓ	Shank Taper Angle Bta	Overall Length L	Shank Diameter ϕd	Price ¥
CZS 4050-0750	5	7.5	16°	60	6	8,400
CZS 4050-1300		13		60		8,400
CZS 4051-1300	5.1	13	16°	60	6	10,500
CZS 4052-1300	5.2	13	16°	60	6	10,500
CZS 4053-1300	5.3	13	16°	60	6	10,500
CZS 4054-1300	5.4	13	16°	60	6	10,500
CZS 4055-1300	5.5	13	16°	60	6	9,600
CZS 4056-1300	5.6	13	16°	60	6	10,500
CZS 4057-1300	5.7	13	16°	60	6	10,500
CZS 4058-1300	5.8	13	16°	60	6	10,500
CZS 4059-1300	5.9	13	16°	60	6	10,500
CZS 4060-0900	6	9	—	60	6	8,700
CZS 4060-1300		13		60		8,700
CZS 4060-1800		18		60		9,600
CZS 4065-1600	6.5	16	16°	70	8	12,600
CZS 4070-1050	7	10.5	16°	70	8	11,300
CZS 4070-1600		16		70		11,300
CZS 4070-2100		21		70		12,500
CZS 4075-1600	7.5	16	16°	70	8	12,600
CZS 4080-1200	8	12	—	70	8	11,300
CZS 4080-1900		19		70		11,300
CZS 4080-2400		24		70		12,500
CZS 4085-1900	8.5	19	16°	80	10	14,600
CZS 4090-1350	9	13.5	16°	80	10	13,200
CZS 4090-1900		19		80		13,200
CZS 4090-2700		27		80		16,700
CZS 4095-1900	9.5	19	16°	80	10	14,600
CZS 4100-1500	10	15	—	80	10	13,200
CZS 4100-2200		22		80		13,200
CZS 4100-3000		30		80		14,600
CZS 4105-2200	10.5	22	16°	100	12	21,000
CZS 4110-1650	11	16.5	16°	100	12	19,300
CZS 4110-2200		22		100		19,300
CZS 4110-3300		33		100		23,000

UDC Series

CBN Series

Square
Long Neck Square

Radius
Long Neck Radius
Taper Neck Radius

Ball / Long Shank Ball
Long Neck Ball
Taper Neck Ball

Taper

Spiral V Cutter

Drill

EURO Series

Technical Data

Next Page ➡

Unit (mm)

Model Number	Outside Diameter ϕD	Length of Cut ℓ	Shank Taper Angle $B\alpha$	Overall Length L	Shank Diameter ϕd	Price ¥
CZS 4115-2200	11.5	22	16°	100	12	21,000
CZS 4120-1800	12	18	—	100	12	19,300
CZS 4120-2600		26		100	12	19,300
CZS 4120-3600		36		100	12	21,300
CZS 4130-2600		13		26	—	110
CZS 4160-2400	16	24	—	110	16	54,200
CZS 4160-3200		32		110	16	57,000
CZS 4200-3000	20	30	—	125	20	79,800
CZS 4200-4000		40		125	20	84,000

4 Flutes

UDC Series

CBN Series

Square

Long Neck Square

Radius

Radius

Long Neck Radius

Taper Neck Radius

Ball / Long Shank Ball

Ball

Long Neck Ball

Taper Neck Ball

Taper

Taper

Spiral V Cutter

Drill

EURO Series

Technical Data

CZS Series
S50C
Milling Video

Milling Conditions for CZS

◆1.5D flute length type

WORK MATERIAL			CARBON STEELS S45C / S50C Annealed Materials (~225HB)							
Model Number	Outside Diameter (mm)	Length of Cut (mm)	Spindle Speed (min ⁻¹)	Vertical		Slotting		Side Milling		
				Feed Rate (mm/min)	a _p Axial Depth (mm)	Feed Rate (mm/min)	a _p Axial Depth (mm)	Feed Rate (mm/min)	a _p Axial Depth (mm)	a _e Radial Depth (mm)
4010-0150	1	1.5	18,000	150	1	200	1	1,200	1.5	0.1※
4015-0225	1.5	2.25	16,000	200	1.5	550	1.5	1,800	2.25	0.15※
4020-0300	2	3	12,000	200	2	550	2	1,800	3	0.2※
4025-0375	2.5	3.75	10,000	300	2.5	950	2.5	2,400	3.75	0.25※
4030-0450	3	4.5	8,500	300	3	950	3	2,400	4.5	0.3※
4040-0600	4	6	7,200	300	4	950	4	1,350	6	0.8
4050-0750	5	7.5	6,000	300	5	1,000	5	1,500	7.5	1
4060-0900	6	9	5,000	300	6	1,000	6	1,600	9	1.2
4070-1050	7	10.5	4,200	300	7	1,000	7	1,500	10.5	1.4
4080-1200	8	12	3,500	300	8	950	8	1,400	12	1.6
4090-1350	9	13.5	2,900	300	9	950	9	1,300	13.5	1.8
4100-1500	10	15	2,300	300	10	900	10	1,200	15	2
4110-1650	11	16.5	2,050	280	11	900	11	1,150	16.5	2.2
4120-1800	12	18	1,850	260	12	850	12	1,100	18	2.4
4160-2400	16	24	1,380	150	Step Amount: 1.6 Max depth 10※	830	8※	550	24	3.2
4200-3000	20	30	1,000	150	Step Amount: 2 Max depth 10※	830	10※	500	30	4
Milling Amount (mm)				※ Depth: 1D Depth: 0.1D (Max 10 mm)		※ a _p : 1D ※ a _p : 0.5D		a _p : Length of Cut ※ a _e : 0.2D ※ a _e : 0.1D		

WORK MATERIAL			ALLOY STEELS SK / SCM Annealed Materials (225~325HB)							
Model Number	Outside Diameter (mm)	Length of Cut (mm)	Spindle Speed (min ⁻¹)	Vertical		Slotting		Side Milling		
				Feed Rate (mm/min)	a _p Axial Depth (mm)	Feed Rate (mm/min)	a _p Axial Depth (mm)	Feed Rate (mm/min)	a _p Axial Depth (mm)	a _e Radial Depth (mm)
4010-0150	1	1.5	14,500	50	1	150	1	900	1.5	0.1※
4015-0225	1.5	2.25	13,000	80	1.5	400	1.5	1,200	2.25	0.15※
4020-0300	2	3	10,000	80	2	400	2	1,200	3	0.2※
4025-0375	2.5	3.75	8,000	100	2.5	650	2.5	1,800	3.75	0.25※
4030-0450	3	4.5	6,800	100	3	650	3	1,800	4.5	0.3※
4040-0600	4	6	5,700	110	4	650	4	1,000	6	0.8
4050-0750	5	7.5	4,800	110	5	700	5	1,100	7.5	1
4060-0900	6	9	4,000	120	6	700	6	1,200	9	1.2
4070-1050	7	10.5	3,400	110	6※1	700	7	1,150	10.5	1.4
4080-1200	8	12	2,700	110	6※1	700	8	1,050	12	1.6
4090-1350	9	13.5	2,300	100	6※1	700	9	1,000	13.5	1.8
4100-1500	10	15	1,900	100	6※1	650	10	900	15	2
4110-1650	11	16.5	1,700	90	6※1	650	11	850	16.5	2.2
4120-1800	12	18	1,550	80	6※1	600	12	800	18	2.4
4160-2400	16	24	1,100	150	Step Amount: 1.6 Max 10 depth※2	400	8※	440	24	3.2
4200-3000	20	30	880	150	Step Amount: 2 Max 10 depth※2	400	10※	440	30	4
Milling Amount (mm)				※1 Depth: 1D Max 6 mm ※2 0.1D depth (Max 10 mm)		※ a _p : 1D ※ a _p : 0.5D		a _p : Length of Cut ※ a _e : 0.2D ※ a _e : 0.1D		

Milling Conditions for CZS

WORK MATERIAL			STRUCTURAL STEELS SS400 Recommend water soluble or oil coolant. (Use cutting oils for vertical milling.)							
Model Number	Outside Diameter (mm)	Length of Cut (mm)	Spindle Speed (min ⁻¹)	Vertical		Slotting		Side Milling		
				Feed Rate (mm/min)	a_p Axial Depth (mm)	Feed Rate (mm/min)	a_p Axial Depth (mm)	Feed Rate (mm/min)	a_p Axial Depth (mm)	a_e Radial Depth (mm)
4010-0150	1	1.5	18,000	100	0.25※1	400	0.25※1	1,200	1.5	0.1※
4015-0225	1.5	2.25	16,000	100	0.375※1	600	0.375※1	1,800	2.25	0.15※
4020-0300	2	3	12,000	200	0.5※1	600	0.5※1	1,800	3	0.2※
4025-0375	2.5	3.75	10,000	300	1.25	950	2.5	2,400	3.75	0.25※
4030-0450	3	4.5	8,500	300	1.5	950	3	2,400	4.5	0.3※
4040-0600	4	6	7,200	300	2	950	4	1,350	6	0.8
4050-0750	5	7.5	6,000	300	2.5	1,000	5	1,500	7.5	1
4060-0900	6	9	5,000	300	3	1,000	6	1,600	9	1.2
4070-1050	7	10.5	4,200	300	3.5	900	7	1,500	10.5	1.4
4080-1200	8	12	3,500	250	4	850	8	1,400	12	1.6
4090-1350	9	13.5	2,900	250	4.5	800	9	1,300	13.5	1.8
4100-1500	10	15	2,300	200	5	750	10	1,200	15	2
4110-1650	11	16.5	2,050	200	5.5	750	11	1,150	16.5	2.2
4120-1800	12	18	1,850	180	6	700	12	1,100	18	2.4
4160-2400	16	24	1,380	150	Step Amount: 1.6 Max 10 depth※2	830	8※2	550	24	3.2
4200-3000	20	30	1,000	150	Step Amount: 2 Max 10 depth※2	830	10※2	500	30	4
Milling Amount (mm)				※1 Depth: 0.5D Depth: 0.25D ※2 Depth: 0.1D (Max 10 mm)		※1 a_p : 1D a_p : 0.25D ※2 a_p : 0.5D		※ a_p : Length of Cut a_e : 0.2D a_e : 0.1D		

WORK MATERIAL			STAINLESS STEELS SUS304 Use water soluble or oil coolant.							
Model Number	Outside Diameter (mm)	Length of Cut (mm)	Spindle Speed (min ⁻¹)	Vertical		Slotting		Side Milling		
				Feed Rate (mm/min)	a_p Axial Depth (mm)	Feed Rate (mm/min)	a_p Axial Depth (mm)	Feed Rate (mm/min)	a_p Axial Depth (mm)	a_e Radial Depth (mm)
4010-0150	1	1.5	14,500	150	0.25	250	1	1,000	1.5	0.05※
4015-0225	1.5	2.25	13,000	150	0.375	270	1.5	1,500	2.25	0.075※
4020-0300	2	3	10,000	100	0.5	270	2	1,500	3	0.1※
4025-0375	2.5	3.75	8,000	100	0.625	300	2.5	2,000	3.75	0.125※
4030-0450	3	4.5	6,800	80	0.75	300	3	2,000	4.5	0.15※
4040-0600	4	6	5,700	90	1	350	4	1,150	6	0.4
4050-0750	5	7.5	4,800	100	1.25	400	5	1,300	7.5	0.5
4060-0900	6	9	4,000	100	1.5	400	6	1,300	9	0.6
4070-1050	7	10.5	3,200	100	1.75	350	7	1,300	10.5	0.7
4080-1200	8	12	2,400	90	2※	300	8	1,200	12	0.8
4090-1350	9	13.5	1,800	90	2※	250	9	1,100	13.5	0.9
4100-1500	10	15	1,400	80	2※	200	10	1,000	15	1
4110-1650	11	16.5	1,250	80	2※	200	11	900	16.5	1.1
4120-1800	12	18	1,250	70	2※	180	12	900	18	1.2
4160-2400	16	24	1,250	70	2※	450	6.4※	440	24	1.6
4200-3000	20	30	1,000	70	2※	450	8※	440	30	2
Milling Amount (mm)				※ Depth: 0.25D Max 2 mm depth		※ a_p : 1D a_p : 0.4D		※ a_p : Length of Cut a_e : 0.1D a_e : 0.05D		

4 Flutes

UDC Series

CBN Series

Square

Long Neck Square

Radius

Long Neck Radius

Taper Neck Radius

Ball / Long Shank Ball

Long Neck Ball

Taper Neck Ball

Taper

Spiral V Cutter

Drill

EURO Series

Technical Data

Milling Conditions for CZS

WORK MATERIAL			PREHARDENED STEELS HPM / NAK (30~45HRC)							
Model Number	Outside Diameter (mm)	Length of Cut (mm)	Spindle Speed (min ⁻¹)	Vertical		Slotting		Side Milling		
				Feed Rate (mm/min)	a _p Axial Depth (mm)	Feed Rate (mm/min)	a _p Axial Depth (mm)	Feed Rate (mm/min)	a _p Axial Depth (mm)	a _e Radial Depth (mm)
4010-0150	1	1.5	14,500	100	0.5	120	1	600	1.5	0.05※
4015-0225	1.5	2.25	12,000	150	0.75	320	1.5	900	2.25	0.075※
4020-0300	2	3	9,000	150	1	320	2	900	3	0.1※
4025-0375	2.5	3.75	7,500	200	1.25	520	2.5	1,200	3.75	0.125※
4030-0450	3	4.5	6,800	200	1.5	520	3	1,200	4.5	0.15※
4040-0600	4	6	5,100	220	2	520	4	700	6	0.4
4050-0750	5	7.5	4,050	240	2.5	520	5	850	7.5	0.5
4060-0900	6	9	3,300	240	3	520	6	1,000	9	0.6
4070-1050	7	10.5	2,900	240	3※	500	6※1	1,000	10.5	0.7
4080-1200	8	12	2,300	220	3※	470	6※1	900	12	0.8
4090-1350	9	13.5	1,900	220	3※	470	6※1	900	13.5	0.9
4100-1500	10	15	1,500	200	3※	450	6※1	900	15	1
4110-1650	11	16.5	1,350	200	3※	450	6※1	850	16.5	1.1
4120-1800	12	18	1,200	180	3※	420	6※1	800	18	1.2
4160-2400	16	24	1,110	150	3※	400	4~8※2	440	24	0.8※
4200-3000	20	30	880	150	3※	400	5~10※2	440	30	1※
Milling Amount (mm)				※ Depth: 0.5D Max 3 mm depth		a _p : 1D ※1 a _p : Max 6 mm ※2 a _p : 0.25~0.5D		a _p : Length of Cut a _e : 0.1D ※ a _e : 0.05D		

WORK MATERIAL			HARDENED STEELS SKD / SKT / STAVAX (45~55HRC)							
Model Number	Outside Diameter (mm)	Length of Cut (mm)	Spindle Speed (min ⁻¹)	Vertical		Slotting		Side Milling		
				Feed Rate (mm/min)	a _p Axial Depth (mm)	Feed Rate (mm/min)	a _p Axial Depth (mm)	Feed Rate (mm/min)	a _p Axial Depth (mm)	a _e Radial Depth (mm)
4010-0150	1	1.5	12,900	80	0.25	50	0.25※1	300	1.5	0.05※
4015-0225	1.5	2.25	10,000	150	0.375	100	0.375※1	650	2.25	0.075※
4020-0300	2	3	8,200	150	0.5	150	0.5※1	650	3	0.1※
4025-0375	2.5	3.75	7,000	250	0.625	300	2.5	1,000	3.75	0.125※
4030-0450	3	4.5	6,120	250	0.75	300	3	1,000	4.5	0.15※
4040-0600	4	6	5,000	220	1	320	4	600	6	0.4
4050-0750	5	7.5	4,300	180	1.25	340	5	800	7.5	0.5
4060-0900	6	9	3,600	160	1.5	360	6	1,000	9	0.6
4070-1050	7	10.5	2,800	160	1.5※	320	7	1,000	10.5	0.7
4080-1200	8	12	2,100	150	1.5※	280	8	1,000	12	0.8
4090-1350	9	13.5	1,600	130	1.5※	240	9	950	13.5	0.9
4100-1500	10	15	1,250	120	1.5※	200	10	750	15	1
4110-1650	11	16.5	1,150	110	1.5※	190	11	720	16.5	1.1
4120-1800	12	18	1,050	110	1.5※	180	12	700	18	1.2
4160-2400	16	24	800	50	1.5※	300	1.6※2	320	24	0.8※
4200-3000	20	30	630	50	1.5※	300	2※2	320	30	1※
Milling Amount (mm)				※ Depth: 0.25D Max 1.5 mm		a _p : 1D ※1 a _p : 0.25D ※2 a _p : 0.1D		a _p : Length of Cut a _e : 0.1D ※ a _e : 0.05D		

UDC Series

CBN Series

Square
Long Neck Square

Radius

Radius
Long Neck Radius
Taper Neck Radius

Ball / Long Shank Ball

Ball
Long Neck Ball
Taper Neck Ball

Taper

Spiral V Cutter

Drill

EURO Series

Technical Data

Milling Conditions for CZS

◆ Standard flute length type

WORK MATERIAL			CARBON STEELS S45C / S50C Annealed Materials (~225HB)							
Model Number	Outside Diameter (mm)	Length of Cut (mm)	Spindle Speed (min ⁻¹)	Vertical		Slotting		Side Milling		
				Feed Rate (mm/min)	a_p Axial Depth (mm)	Feed Rate (mm/min)	a_p Axial Depth (mm)	Feed Rate (mm/min)	a_p Axial Depth (mm)	a_e Radial Depth (mm)
4010-0250	1	2.5	18,000	100	1	200	0.5※	1,200	1.5	0.1※
4020-0600	2	6	12,000	150	2	400	1※	1,800	3	0.2※
4030-0800	3	8	8,500	250	3	600	3	2,400	4.5	0.3※
4040-1100	4	11	7,200	270	4	650	4	1,350	6	0.8
4050-1300	5	13	6,000	300	5	700	5	1,500	7.5	1
4060-1300	6	13	5,000	300	6	700	6	1,600	9	1.2
4070-1600	7	16	4,200	300	7	700	7	1,500	10.5	1.4
4080-1900	8	19	3,500	300	8	700	8	1,400	12	1.6
4090-1900	9	19	2,900	300	9	700	9	1,300	13.5	1.8
4100-2200	10	22	2,300	300	10	700	10	1,200	15	2
4110-2200	11	22	2,050	280	11	670	11	1,150	16.5	2.2
4120-2600	12	26	1,850	260	12	650	12	1,100	18	2.4
4130-2600	13	26	1,400	80	13	300	13	700	19.5	1.3※
4160-3200	16	32	1,380	150	Step Amount: 1.6 Max 10 depth※	830	8※	550	24	3.2
4200-4000	20	40	1,000	150	Step Amount: 2 Max 10 depth※	830	10※	500	30	4
Milling Amount (mm)				※ Depth: 1D Depth: 0.1D (Max 10 mm)		※ a_p : 1D ※ a_p : 0.5D		※ a_p : 1.5D ※ a_e : 0.2D ※ a_e : 0.1D		

WORK MATERIAL			ALLOY STEELS SK / SCM Annealed Materials (225~325HB)							
Model Number	Outside Diameter (mm)	Length of Cut (mm)	Spindle Speed (min ⁻¹)	Vertical		Slotting		Side Milling		
				Feed Rate (mm/min)	a_p Axial Depth (mm)	Feed Rate (mm/min)	a_p Axial Depth (mm)	Feed Rate (mm/min)	a_p Axial Depth (mm)	a_e Radial Depth (mm)
4010-0250	1	2.5	14,500	50	1	150	0.5※	900	1.5	0.1※
4020-0600	2	6	10,000	80	2	300	1※	1,200	3	0.2※
4030-0800	3	8	6,800	100	3	400	3	1,800	4.5	0.3※
4040-1100	4	11	5,700	110	4	450	4	1,000	6	0.8
4050-1300	5	13	4,800	110	5	500	5	1,100	7.5	1
4060-1300	6	13	4,000	120	6	500	6	1,200	9	1.2
4070-1600	7	16	3,400	110	6※1	500	7	1,150	10.5	1.4
4080-1900	8	19	2,700	110	6※1	500	8	1,050	12	1.6
4090-1900	9	19	2,300	100	6※1	500	9	1,000	13.5	1.8
4100-2200	10	22	1,900	100	6※1	500	10	900	15	2
4110-2200	11	22	1,700	90	6※1	450	11	850	16.5	2.2
4120-2600	12	26	1,550	80	6※1	450	12	800	18	2.4
4130-2600	13	26	1,100	25	6※1	180	13	550	19.5	1.3※
4160-3200	16	32	1,100	150	Step Amount: 1.6 Max 10 depth※2	300	8※	440	24	3.2
4200-4000	20	40	880	150	Step Amount: 2 Max 10 depth※2	300	10※	440	30	4
Milling Amount (mm)				※1 Depth: 1D Max 6 mm ※2 Depth: 0.1D (Max 10 mm)		※ a_p : 1D ※ a_p : 0.5D		※ a_p : 1.5D ※ a_e : 0.2D ※ a_e : 0.1D		

4 Flutes

UDC Series

CBN Series

Square

Long Neck Square

Radius

Long Neck Radius

Taper Neck Radius

Ball / Long Shank Ball

Long Neck Ball

Taper Neck Ball

Taper

Spiral V Cutter

Drill

EURO Series

Technical Data

Milling Conditions for CZS

WORK MATERIAL			STRUCTURAL STEELS SS400 Recommend water soluble or oil coolant. (Use cutting oils for vertical milling.)							
Model Number	Outside Diameter (mm)	Length of Cut (mm)	Spindle Speed (min ⁻¹)	Vertical		Slotting		Side Milling		
				Feed Rate (mm/min)	a _p Axial Depth (mm)	Feed Rate (mm/min)	a _p Axial Depth (mm)	Feed Rate (mm/min)	a _p Axial Depth (mm)	a _e Radial Depth (mm)
4010-0250	1	2.5	18,000	100	0.25※1	400	0.25※1	1,200	1.5	0.1※
4020-0600	2	6	12,000	200	0.5※1	600	0.5※1	1,800	3	0.2※
4030-0800	3	8	8,500	300	1.5	600	3	2,400	4.5	0.3※
4040-1100	4	11	7,200	300	2	650	4	1,350	6	0.8
4050-1300	5	13	6,000	300	2.5	700	5	1,500	7.5	1
4060-1300	6	13	5,000	300	3	700	6	1,600	9	1.2
4070-1600	7	16	4,200	270	3.5	700	7	1,500	10.5	1.4
4080-1900	8	19	3,500	250	4	700	8	1,400	12	1.6
4090-1900	9	19	2,900	220	4.5	700	9	1,300	13.5	1.8
4100-2200	10	22	2,300	200	5	700	10	1,200	15	2
4110-2200	11	22	2,050	190	5.5	680	11	1,150	16.5	2.2
4120-2600	12	26	1,850	180	6	650	12	1,100	18	2.4
4130-2600	13	26	1,100	55	6.5	180	13	550	19.5	1.3※
4160-3200	16	32	1,380	150	Step Amount: 1.6 Max 10 depth※2	830	8※2	550	24	3.2
4200-4000	20	40	1,000	150	Step Amount: 2 Max 10 depth※2	830	10※2	500	30	4
Milling Amount (mm)				※1 Depth: 0.5D ※2 Depth: 0.25D (Max 10 mm)		a _p : 1D ※1 a _p : 0.25D ※2 a _p : 0.5D		a _p : 1.5D a _e : 0.2D ※ a _e : 0.1D		

WORK MATERIAL			STAINLESS STEELS SUS304 Use water soluble or oil coolant.							
Model Number	Outside Diameter (mm)	Length of Cut (mm)	Spindle Speed (min ⁻¹)	Vertical		Slotting		Side Milling		
				Feed Rate (mm/min)	a _p Axial Depth (mm)	Feed Rate (mm/min)	a _p Axial Depth (mm)	Feed Rate (mm/min)	a _p Axial Depth (mm)	a _e Radial Depth (mm)
4010-0250	1	2.5	14,500	150	0.25	250	0.5	1,000	1.5	0.05※
4020-0600	2	6	10,000	100	0.5	270	1	1,500	3	0.1※
4030-0800	3	8	6,800	80	0.75	300	1.5	2,000	4.5	0.15※
4040-1100	4	11	5,700	90	1	350	2	1,150	6	0.4
4050-1300	5	13	4,800	100	1.25	400	2.5	1,300	7.5	0.5
4060-1300	6	13	4,000	100	1.5	400	3	1,300	9	0.6
4070-1600	7	16	3,200	100	1.75	350	3.5	1,300	10.5	0.7
4080-1900	8	19	2,400	90	2※1	300	4	1,200	12	0.8
4090-1900	9	19	1,800	90	2※1	250	4.5	1,100	13.5	0.9
4100-2200	10	22	1,400	80	2※1	200	5	1,000	15	1
4110-2200	11	22	1,250	80	2※1	200	5.5	900	16.5	1.1
4120-2600	12	26	1,250	70	2※1	180	6	900	18	1.2
4130-2600	13	26	1,050	20	1.5※2	120	6.5	900	19.5	0.65※
4160-3200	16	32	1,250	70	2※1	450	1.6※	440	24	1.6
4200-4000	20	40	1,000	70	2※1	450	2※	440	30	2
Milling Amount (mm)				※1 Depth: 0.25D ※2 Max 2 mm depth (Max 1.5 mm depth)		a _p : 0.5D ※ a _p : 0.1D		a _p : 1.5D a _e : 0.1D ※ a _e : 0.05D		

Milling Conditions for CZS

4 Flutes

WORK MATERIAL			PREHARDENED STEELS HPM / NAK (30~45HRC)							
Model Number	Outside Diameter (mm)	Length of Cut (mm)	Spindle Speed (min ⁻¹)	Vertical		Slotting		Side Milling		
				Feed Rate (mm/min)	a_p Axial Depth (mm)	Feed Rate (mm/min)	a_p Axial Depth (mm)	Feed Rate (mm/min)	a_p Axial Depth (mm)	a_e Radial Depth (mm)
4010-0250	1	2.5	12,900	80	0.5	140	1	270	1.5	0.2
4020-0600	2	6	9,350	110	1	230	2	400	3	0.4
4030-0800	3	8	6,120	120	1.5	270	3	450	4.5	0.6
4040-1100	4	11	5,250	130	2	320	4	500	6	0.8
4050-1300	5	13	4,460	150	2.5	360	5	540	7.5	1
4060-1300	6	13	3,600	160	3	360	6	540	9	1.2
4070-1600	7	16	2,850	140	2**	340	7	540	10.5	1.4
4080-1900	8	19	2,320	90	2**	320	8	480	12	1.6
4090-1900	9	19	1,700	80	2**	250	9	410	13.5	1.8
4100-2200	10	22	1,250	60	2**	180	10	340	15	2
4110-2200	11	22	1,100	55	2**	170	11	320	16.5	2.2
4120-2600	12	26	1,050	50	2**	160	12	320	18	2.4
4130-2600	13	26	1,000	setting disable	setting disable	100	6.5**	300	19.5	1.3**
4160-3200	16	32	960	40	2**	350	8**	380	24	1.6**
4200-4000	20	40	770	40	2**	350	10**	380	30	2**
Milling Amount (mm)				Depth: 0.5D ** Max 2 mm depth		a_p :1D ** a_p :0.5D		a_p :1.5D a_e :0.2D ** a_e :0.1D		

WORK MATERIAL			HARDENED STEELS SKD / SKT / STAVAX (45~55HRC)							
Model Number	Outside Diameter (mm)	Length of Cut (mm)	Spindle Speed (min ⁻¹)	Vertical		Slotting		Side Milling		
				Feed Rate (mm/min)	a_p Axial Depth (mm)	Feed Rate (mm/min)	a_p Axial Depth (mm)	Feed Rate (mm/min)	a_p Axial Depth (mm)	a_e Radial Depth (mm)
4010-0250	1	2.5	12,900	80	0.25	50	0.25**1	300	1.5	0.05**
4020-0600	2	6	8,200	150	0.5	150	0.5**1	650	3	0.1**
4030-0800	3	8	6,120	250	0.75	300	1.5	1,000	4.5	0.15**
4040-1100	4	11	5,000	220	1	320	2	500	6	0.4
4050-1300	5	13	4,300	180	1.25	340	2.5	520	7.5	0.5
4060-1300	6	13	3,600	160	1.5	360	3	540	9	0.6
4070-1600	7	16	2,800	160	1.5**1	320	3.5	520	10.5	0.7
4080-1900	8	19	2,100	150	1.5**1	280	4	500	12	0.8
4090-1900	9	19	1,600	130	1.5**1	240	4.5	470	13.5	0.9
4100-2200	10	22	1,250	120	1.5**1	200	5	450	15	1
4110-2200	11	22	1,150	110	1.5**1	190	5.5	440	16.5	1.1
4120-2600	12	26	1,050	110	1.5**1	180	6	420	18	1.2
4130-2600	13	26	900	setting disable	setting disable	setting disable	setting disable	370	19.5	0.65**
4160-3200	16	32	800	50	Step Amount: 1.6 Max 10 depth**2	300	1.6**2	320	24	0.8**
4200-4000	20	40	630	50	Step Amount: 2 Max 10 depth**2	300	2**2	320	30	1**
Milling Amount (mm)				Depth: 0.25D **1 Max 1.5 mm **2 Depth: 0.1D (Max 10 mm)		a_p :0.5D **1 a_p :0.25D **2 a_p :0.1D		a_p :1.5D a_e :0.1D ** a_e :0.05D		

- UDC Series
- CBN Series
- Square
- Long Neck Square
- Radius
- Long Neck Radius
- Taper Neck Radius
- Ball / Long Shank Ball
- Long Neck Ball
- Taper Neck Ball
- Taper
- Spiral V Cutter
- Drill
- EURO Series
- Technical Data

Milling Conditions for CZS

◆3D flute length type

WORK MATERIAL			CARBON STEELS S45C / S50C Annealed Materials (~225HB)							
Model Number	Outside Diameter (mm)	Length of Cut (mm)	Spindle Speed (min ⁻¹)	Vertical		Slotting		Side Milling		
				Feed Rate (mm/min)	a_p Axial Depth (mm)	Feed Rate (mm/min)	a_p Axial Depth (mm)	Feed Rate (mm/min)	a_p Axial Depth (mm)	a_e Radial Depth (mm)
4060-1800	6	18	5,000	200	6	500	6	1,600	18	0.6
4070-2100	7	21	4,100	200	7	450	7	1,450	21	0.7
4080-2400	8	24	3,200	150	8	400	8	1,300	24	0.8
4090-2700	9	27	2,400	140	9	350	9	1,150	27	0.9
4100-3000	10	30	1,850	120	10	320	10	1,000	30	1
4110-3300	11	33	1,650	100	11	300	11	900	33	1.1
4120-3600	12	36	1,500	90	12	300	12	800	36	1.2
Milling Amount (mm)				Depth: 1D		a_p : 1D		a_p : Length of Cut a_e : 0.1D		

WORK MATERIAL			ALLOY STEELS SK / SCM Annealed Materials (225~325HB)							
Model Number	Outside Diameter (mm)	Length of Cut (mm)	Spindle Speed (min ⁻¹)	Vertical		Slotting		Side Milling		
				Feed Rate (mm/min)	a_p Axial Depth (mm)	Feed Rate (mm/min)	a_p Axial Depth (mm)	Feed Rate (mm/min)	a_p Axial Depth (mm)	a_e Radial Depth (mm)
4060-1800	6	18	4,000	60	6	350	6	1,200	18	0.6
4070-2100	7	21	3,400	60	6	330	7	1,150	21	0.7
4080-2400	8	24	2,700	50	6	300	8	1,050	24	0.8
4090-2700	9	27	2,050	50	6	270	9	1,000	27	0.9
4100-3000	10	30	1,500	40	6	240	10	900	30	1
4110-3300	11	33	1,350	40	6	220	11	850	33	1.1
4120-3600	12	36	1,200	30	6	200	12	750	36	1.2
Milling Amount (mm)				Max 6 mm depth		a_p : 1D		a_p : Length of Cut a_e : 0.1D		

WORK MATERIAL			STRUCTURAL STEELS SS400 Recommend water soluble or oil coolant. (Use cutting oils for vertical milling.)							
Model Number	Outside Diameter (mm)	Length of Cut (mm)	Spindle Speed (min ⁻¹)	Vertical		Slotting		Side Milling		
				Feed Rate (mm/min)	a_p Axial Depth (mm)	Feed Rate (mm/min)	a_p Axial Depth (mm)	Feed Rate (mm/min)	a_p Axial Depth (mm)	a_e Radial Depth (mm)
4060-1800	6	18	4,000	120	3	300	6	1,300	18	0.6
4070-2100	7	21	3,400	110	3.5	280	7	1,200	21	0.7
4080-2400	8	24	2,700	90	4	250	8	1,150	24	0.8
4090-2700	9	27	2,100	80	4.5	230	9	1,050	27	0.9
4100-3000	10	30	1,500	70	5	200	10	1,000	30	1
4110-3300	11	33	1,350	65	5.5	190	11	950	33	1.1
4120-3600	12	36	1,200	60	6	190	12	900	36	1.2
Milling Amount (mm)				Depth: 0.5D		a_p : 1D		a_p : Length of Cut a_e : 0.1D		

- UDC Series
- CBN Series
- Square
- Long Neck Square
- Radius
- Long Neck Radius
- Taper Neck Radius
- Ball / Long Shark Ball
- Long Neck Ball
- Taper Neck Ball
- Taper
- Spiral V Cutter
- Drill
- EURO Series
- Technical Data

Milling Conditions for CZS

WORK MATERIAL			STAINLESS STEELS SUS304 Use water soluble or oil coolant.							
Model Number	Outside Diameter (mm)	Length of Cut (mm)	Spindle Speed (min ⁻¹)	Vertical		Slotting		Side Milling		
				Feed Rate (mm/min)	a_p Axial Depth (mm)	Feed Rate (mm/min)	a_p Axial Depth (mm)	Feed Rate (mm/min)	a_p Axial Depth (mm)	a_e Radial Depth (mm)
4060-1800	6	18	2,800	40	1.5	200	3	900	18	0.3
4070-2100	7	21	2,450	40	1.5	190	3.5	950	21	0.35
4080-2400	8	24	2,100	40	1.5	180	4	950	24	0.4
4090-2700	9	27	1,700	30	1.5	170	4.5	1,000	27	0.45
4100-3000	10	30	1,400	30	1.5	150	5	1,000	30	0.5
4110-3300	11	33	1,250	30	1.5	140	5.5	1,000	33	0.55
4120-3600	12	36	1,150	25	1.5	130	6	950	36	0.6
Milling Amount (mm)				Max 1.5 mm depth		a_p : 0.5D		a_p : Length of Cut a_e : 0.05D		

WORK MATERIAL			PREHARDENED STEELS HPM / NAK (30~45HRC)							
Model Number	Outside Diameter (mm)	Length of Cut (mm)	Spindle Speed (min ⁻¹)	Vertical		Slotting		Side Milling		
				Feed Rate (mm/min)	a_p Axial Depth (mm)	Feed Rate (mm/min)	a_p Axial Depth (mm)	Feed Rate (mm/min)	a_p Axial Depth (mm)	a_e Radial Depth (mm)
4060-1800	6	18	3,000	—	—	160	6	600	18	0.3
4070-2100	7	21	2,500	—	—	160	6	700	21	0.35
4080-2400	8	24	2,150	—	—	150	6	750	24	0.4
4090-2700	9	27	1,850	—	—	150	6	800	27	0.45
4100-3000	10	30	1,500	—	—	140	6	900	30	0.5
4110-3300	11	33	1,350	—	—	130	6	850	33	0.55
4120-3600	12	36	1,200	—	—	120	6	800	36	0.6
Milling Amount (mm)				setting disable		a_p : Max 6 mm		a_p : Length of Cut a_e : 0.05D		

WORK MATERIAL			HARDENED STEELS SKD / SKT / STAVAX (45~55HRC)							
Model Number	Outside Diameter (mm)	Length of Cut (mm)	Spindle Speed (min ⁻¹)	Vertical		Slotting		Side Milling		
				Feed Rate (mm/min)	a_p Axial Depth (mm)	Feed Rate (mm/min)	a_p Axial Depth (mm)	Feed Rate (mm/min)	a_p Axial Depth (mm)	a_e Radial Depth (mm)
4060-1800	6	18	3,600	—	—	—	—	540	18	0.3
4070-2100	7	21	2,900	—	—	—	—	520	21	0.35
4080-2400	8	24	2,300	—	—	—	—	500	24	0.4
4090-2700	9	27	1,700	—	—	—	—	470	27	0.45
4100-3000	10	30	1,250	—	—	—	—	450	30	0.5
4110-3300	11	33	1,100	—	—	—	—	420	33	0.55
4120-3600	12	36	1,000	—	—	—	—	400	36	0.6
Milling Amount (mm)				setting disable		setting disable		a_p : Length of Cut a_e : 0.05D		

4 Flutes

UDC Series

CBN Series

Square

Square
Long Neck Square

Radius

Radius
Long Neck Radius

Taper Neck Radius

Ball / Long Shank Ball

Ball
Long Neck Ball

Taper Neck Ball

Taper

Spiral V Cutter

Drill

EURO Series

Technical Data

Milling Conditions for CZS

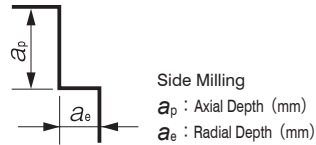
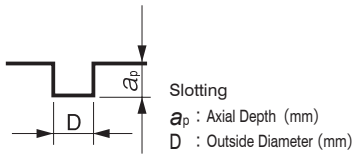

Note:

- Decrease both spindle speed and feed rate proportionally when the milling parameters exceed the machines maximum speed, or when the tool is chattering and heats up to a red color.
- These milling parameters are calculated based on the shortest overhang length. Longer overhangs may require an adjustment to the milling parameters.
- Reduce the milling amount and feed rate in accordance with required milling precision.
- Spindle rigidity should be considered when setting milling parameters, especially for Z-Axis drilling.
- When slotting, using Z-Axis drilling, the milling parameters should promote good chip evacuation.
- Reduce the milling amount when chips clog on the tool during Z-Axis drilling.
- The milling parameter of outside diameter 16 and 20 is calculated based on BT50 spindle type. Decrease 50% milling amount for BT40 spindle type.
- Recommend water soluble or oil coolant.
- Recommend water soluble coolant (through spindle type) for Stainless Steels and Aluminum Alloys.
- Recommend oil coolant for Titanium Alloys and Heat Resistant Alloys.

CZS The 2 in 1 Advantage

4 Flute UTCOAT Square End Mills for Part Milling

Patented special tip profile design

Drilling and Milling in a Single Tool! 1/2 Cycle Time!



Drilling and Milling in a Single Tool

Special Tip Profile Design for Smooth Chip Evacuation

Normal 4 Flutes

Conventional End Profile

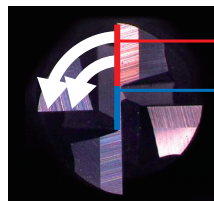

Chips made by the outer edge → Bigger

Chips made by the inner edge → Trapped

Normal 4 flute end mill easily clogs → Impossible to Drill

Drilling Mechanism

CZS

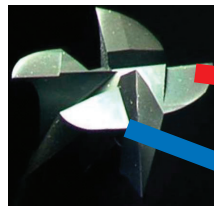

Gap on Main Flute

Main Flute

Sub Flute

Big chips come from the sub flute

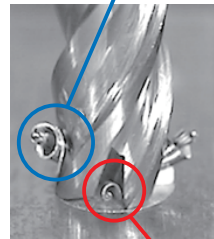

Small chips come from the main flute

The outer edge of the main flutes are not used in the drilling cycle

Good chip evacuation from the inner edge
Allowing for High Speed Drilling

UDC Series

CBN Series

Square

Long Neck Square

Radius

Long Neck Radius

Taper Neck Radius

Ball / Long Shank Ball

Long Neck Ball

Taper Neck Ball

Taper

Spiral V Cutter

Drill

EURO Series

Technical Data

Pocket Milling Example
CZS $\phi 8 \times$ Length of Cut 12

SCM420H



Pocket Size : $9 \times 15 \times$ Depth 4 mm

Spindle Speed	2,700 min ⁻¹
Z-Drilling Feed Rate	220 mm/min
X-Y Milling Feed Rate	500 mm/min
Number of holes	864 holes
Coolant	Water Soluble

Z-drilling Depth 1 mm \times 4 times Dwell 0.1 sec

Drilling and Milling \rightarrow 144 min

CZS \rightarrow 72 min

**1/2
Cycle Time!**

After milling 864 holes (32 pieces)

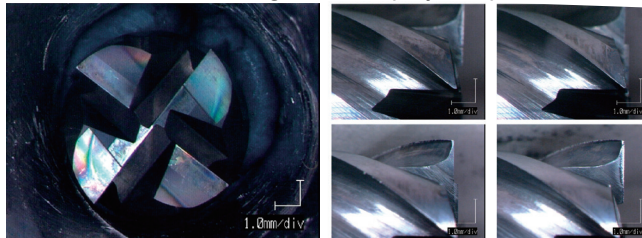

Less cycle time! More tool life left after milling 864 holes!

Comparison with Conventional Model
CZS $\phi 6.5 \times$ Length of Cut 16

S45C

CZS

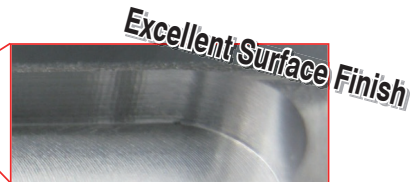
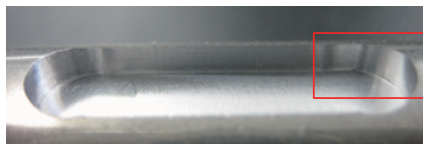
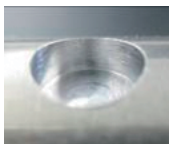

Conventional 4 Flute Square

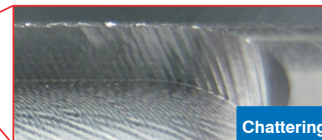
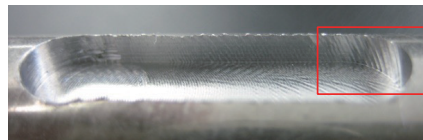

Cantilevered work piece

Spindle Speed	2,200 min ⁻¹
Z-Drilling Feed Rate	100 mm/min
Slotting Feed Rate	400 mm/min
Axial Depth a_p	3 mm
Overhang Length	25 mm
Coolant	Air Blow (Through Spindle)
Milled Size	Slitting $6.5 \times 24.5 \times 3$ mm Spot Facing 6.5×3 mm

Variable Pitch Prevents Chattering!

4 Flutes

UDC Series

CBN Series

Square

Square
Long Neck Square

Radius

Radius
Long Neck Radius

Ball

Taper Neck Radius

Ball

Ball / Long Shank Ball
Long Neck Ball

Taper

Taper Neck Ball

Spiral

V Cutter

Drill

EURO Series

Technical Data



Size $\phi 1 \sim \phi 16$

CXES

Super
MG

UT
COAT

37°~40°

Flatland

Shank Dia
0/-0.005

Variable
Pitch

Variable
Helix

Additional 12 models

Material Applications (☆ Highly Recommended ○ Recommended ○ Suggested)

Work Material															
Carbon Steels S45C S55C	Alloy Steels SK / SCM SUS	Prehardened Steels NAK HPM	Hardened Steels			Cast Iron	Aluminum Alloys	Graphite	Copper	Plastics	Glass Filled Plastics	Titanium Alloys	Heat Resistant Alloys	Cemented Carbide	Hard Brittle (Non-Metallic) Materials
			~55HRC	~60HRC	~70HRC										
○	○	○	○			○			○			○	○		

Features

- Variable Division & Helix design minimizes vibration and chattering.
- Selected high toughness and chip resistant carbide material.
- Optimized flute design offers outstandingly high efficiency milling and fine finishing.
- Low friction coating resulting in excellent chip evacuation and resistance to wear.

The shank taper angle shown is not an exact value and to avoid contact with the work piece, we recommend the user controls the precise value of this angle. Shank taper angle should not make contact with the work piece. Actual measurement is necessary when using longer length of cut than the written length.

Shape A

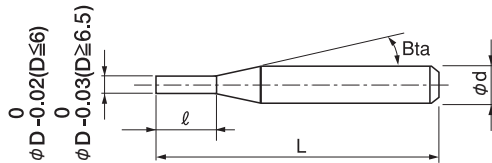

Shape B

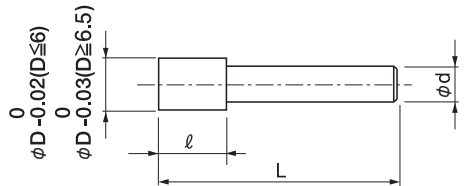

Total 55 models

Unit (mm)

Model Number	Outside Diameter ϕD	Length of Cut ℓ	Shank Taper Angle Bta	Overall Length L	Shank Diameter ϕd	Shape	Price ¥
CXES 4010-0250	1	2.5	16°	50	4	A	6,520
CXES 4010-0300		3		60	4		7,180
CXES 4010-0400		4		60	4		7,900
CXES 4010-0500	1.5	5	16°	60	4	A	10,270
CXES 4015-0375		3.75		50	4		6,520
CXES 4015-0600		6		50	4		7,900
CXES 4020-0500	2	5	16°	50	4	A	6,100
CXES 4020-0600		6		60	4		6,710
CXES 4020-0800		8		60	4		7,390
CXES 4020-1000	2.5	10	16°	60	4	A	9,610
CXES 4025-0625		6.25		50	4		6,100
CXES 4025-1000		10		50	4		7,390

※Additional model

Next Page →

- UDC Series
- CBN Series
- Square
- Long Neck Square
- Radius
- Long Neck Radius
- Taper Neck Radius
- Ball / Long Shank Ball
- Long Neck Ball
- Taper Neck Ball
- Taper
- Spiral V Cutter
- Drill
- EURO Series
- Technical Data

Unit (mm)

Model Number	Outside Diameter ϕD	Length of Cut ℓ	Shank Taper Angle Bta	Overall Length L	Shank Diameter ϕd	Shape	Price ¥
※ CXES 4030-0750	3	7.5	16°	50	6	A	7,000
CXES 4030-0900		9		60	6		7,700
CXES 4030-1200		12		60	6		8,470
※ CXES 4030-1500		15		60	6		11,020
CXES 4035-0900	3.5	9	16°	60	6	A	8,270
CXES 4040-1000	4	10	16°	50	6	A	7,350
CXES 4040-1200		12		60	6		8,090
CXES 4040-1600		16		60	6		8,900
※ CXES 4040-2000		20		60	6		11,570
CXES 4045-1150	4.5	11.5	16°	60	6	A	8,840
CXES 4050-1250	5	12.5	16°	50	6	A	7,900
CXES 4050-1500		15		60	6		8,690
CXES 4050-2000		20		60	6		9,560
※ CXES 4050-2500		25		70	6		12,430
CXES 4055-1400	5.5	14	16°	60	6	A	9,120
CXES 4060-1500	6	15	—	50	6	A	8,500
CXES 4060-1800		18		60	6		9,350
CXES 4060-2400		24		70	6		10,760
※ CXES 4060-3000		30		80	6		13,990
CXES 4065-1650	6.5	16.5	16°	60	8	A	11,970
CXES 4070-1050	7	10.5	—	100	6	B	14,880
※ CXES 4070-1750		17.5	16°	70	8	A	10,500
CXES 4075-1900	7.5	19	16°	60	8	A	11,970
CXES 4080-2000	8	20	—	60	8	A	10,500
CXES 4080-2400		24		70	8		11,550
CXES 4080-3200		32		80	8		15,600
※ CXES 4080-4000		40		90	8		20,280
CXES 4085-2150	8.5	21.5	16°	70	10	A	13,870
CXES 4090-1350	9	13.5	—	140	8	B	19,390
※ CXES 4090-2250		22.5	16°	80	10	A	12,500
CXES 4095-2400	9.5	24	16°	70	10	A	13,870
CXES 4100-2500	10	25	—	70	10	A	12,500
CXES 4100-3000		30		80	10		13,750
CXES 4100-4000		40		90	10		18,570
※ CXES 4100-5000		50		100	10		24,150
CXES 4110-1650	11	16.5	—	150	10	B	24,200
※ CXES 4110-2750		27.5	16°	100	12	A	17,800
CXES 4120-3000	12	30	—	90	12	A	17,800
CXES 4120-3600		36		100	12		19,580
CXES 4120-4800		48		110	12		26,440
※ CXES 4120-6000		60		120	12		34,380
CXES 4130-1950	13	19.5	—	160	12	B	30,390
CXES 4160-4000	16	40	—	110	16	A	54,150

※Additional model

4 Flutes

UDC Series

CBN Series

Square
Long Neck Square

Radius

Long Neck Radius

Taper Neck Radius

Ball / Long Shank Ball

Long Neck Ball

Taper Neck Ball

Taper

Spiral V Cutter

Drill

EURO Series

Technical Data

197

Milling Conditions for CXES

Side Milling

WORK MATERIAL			CARBON STEELS S45C / S50C Annealed Materials (~225HB)				ALLOY STEELS SK / SCM Annealed Materials (225~325HB)				STAINLESS STEELS SUS304 Use water soluble or oil coolant.			
Model Number	Outside Diameter (mm)	Length of Cut (mm)	Spindle Speed (min ⁻¹)	Feed Rate (mm/min)	a _p Axial Depth (mm)	a _e Radial Depth (mm)	Spindle Speed (min ⁻¹)	Feed Rate (mm/min)	a _p Axial Depth (mm)	a _e Radial Depth (mm)	Spindle Speed (min ⁻¹)	Feed Rate (mm/min)	a _p Axial Depth (mm)	a _e Radial Depth (mm)
UDC Series	1	2.5	18,000	620	2.5	0.2	18,000	460	2.5	0.2	14,500	320	2.5	0.1
		3	18,000	620	3	0.03	18,000	460	3	0.03	14,300	310	3	0.015
		4	18,000	620	4	0.02	18,000	460	4	0.02	13,900	290	4	0.01
		5	18,000	620	5	0.02	18,000	460	5	0.02	13,900	290	5	0.01
CBN Series	1.5	3.75	13,500	770	3.75	0.3	13,500	570	3.75	0.3	13,300	340	3.75	0.15
		6	13,500	770	6	0.03	13,500	570	6	0.03	12,700	310	6	0.015
Square	2	5	11,000	930	5	0.4	11,000	690	5	0.4	12,200	360	5	0.2
		6	11,000	930	6	0.06	11,000	690	6	0.06	12,000	340	6	0.03
		8	11,000	930	8	0.04	11,000	690	8	0.04	11,600	300	8	0.02
		10	11,000	930	10	0.04	11,000	690	10	0.04	11,600	300	10	0.02
Long Neck Square	2.5	6.25	9,500	1,060	6.25	0.5	9,500	800	6.25	0.5	11,000	490	6.25	0.25
		10	9,500	1,060	10	0.05	9,500	800	10	0.05	10,400	430	10	0.025
Radius	3	7.5	8,500	1,200	7.5	0.6	8,500	900	7.5	0.6	10,000	640	7.5	0.3
		9	8,500	1,200	9	0.3	8,500	900	9	0.3	9,100	580	9	0.15
		12	8,500	1,200	12	0.06	8,500	900	12	0.06	7,300	460	12	0.03
		15	8,500	1,200	15	0.06	8,500	900	15	0.06	7,300	460	15	0.03
Long Neck Radius	3.5	9	7,800	1,250	9	0.7	7,500	950	9	0.7	8,600	680	9	0.35
		10	7,200	1,350	10	0.8	6,700	1,000	10	0.8	7,500	730	10	0.4
Ball / Long Shark Ball	4	12	7,200	1,350	12	0.4	6,700	1,000	12	0.4	6,600	640	12	0.2
		16	7,200	1,350	16	0.08	6,700	1,000	16	0.08	4,800	460	16	0.08
		20	7,200	1,350	20	0.08	6,700	1,000	20	0.08	4,800	460	20	0.08
		4.5	11.5	6,550	1,400	11.5	0.9	6,000	1,050	11.5	0.9	6,300	770	11.5
Long Neck Ball	5	12.5	6,000	1,500	12.5	1	5,400	1,100	12.5	1	5,400	810	12.5	0.5
		15	6,000	1,500	15	0.5	5,400	1,100	15	0.5	4,600	690	15	0.25
		20	6,000	1,500	20	0.1	5,400	1,100	20	0.1	3,700	450	20	0.1
		25	6,000	1,500	25	0.1	5,400	1,100	25	0.1	3,700	450	25	0.1
Taper Neck Radius	5.5	14	5,450	1,550	14	1.1	4,900	1,150	14	1.1	4,900	810	14	0.55
		15	5,000	1,600	15	1.2	4,500	1,200	15	1.2	4,500	810	15	0.6
Ball	6	18	5,000	1,600	18	0.6	4,500	1,200	18	0.6	3,700	660	18	0.3
		24	5,000	1,400	24	0.12	4,500	1,050	24	0.12	2,900	360	24	0.12
		30	5,000	1,400	30	0.12	4,500	1,050	30	0.12	2,900	360	30	0.12
		6.5	16.5	4,400	1,500	16.5	1.3	3,950	1,150	16.5	1.3	3,950	780	16.5
Taper	6.5	16.5	4,400	1,500	16.5	1.3	3,950	1,150	16.5	1.3	3,950	780	16.5	0.65
		16.5	4,400	1,500	16.5	1.3	3,950	1,150	16.5	1.3	3,950	780	16.5	0.65
Spiral V Cutter	6.5	16.5	4,400	1,500	16.5	1.3	3,950	1,150	16.5	1.3	3,950	780	16.5	0.65
		16.5	4,400	1,500	16.5	1.3	3,950	1,150	16.5	1.3	3,950	780	16.5	0.65
Drill	6.5	16.5	4,400	1,500	16.5	1.3	3,950	1,150	16.5	1.3	3,950	780	16.5	0.65
		16.5	4,400	1,500	16.5	1.3	3,950	1,150	16.5	1.3	3,950	780	16.5	0.65
EURO Series	6.5	16.5	4,400	1,500	16.5	1.3	3,950	1,150	16.5	1.3	3,950	780	16.5	0.65
		16.5	4,400	1,500	16.5	1.3	3,950	1,150	16.5	1.3	3,950	780	16.5	0.65
Technical Data	6.5	16.5	4,400	1,500	16.5	1.3	3,950	1,150	16.5	1.3	3,950	780	16.5	0.65
		16.5	4,400	1,500	16.5	1.3	3,950	1,150	16.5	1.3	3,950	780	16.5	0.65

Milling Conditions for CXES

WORK MATERIAL			PREHARDENED STEELS HPM / NAK (30~45HRC)				HARDENED STEELS SKD / SKT / STAVAX (45~55HRC)			
Model Number	Outside Diameter (mm)	Length of Cut (mm)	Spindle Speed (min ⁻¹)	Feed Rate (mm/min)	a_p Axial Depth (mm)	a_e Radial Depth (mm)	Spindle Speed (min ⁻¹)	Feed Rate (mm/min)	a_p Axial Depth (mm)	a_e Radial Depth (mm)
4010-0250	1	2.5	12,900	320	2.5	0.2	12,900	180	2.5	0.05
4010-0300		3	12,800	320	3	0.03	12,900	180	3	0.015
4010-0400		4	12,600	320	4	0.02	12,900	180	4	0.01
4010-0500		5	12,600	320	5	0.01	12,900	180	5	0.005
4015-0375	1.5	3.75	10,500	390	3.75	0.3	9,300	280	3.75	0.075
4015-0600		6	10,200	390	6	0.03	9,300	280	6	0.015
4020-0500	2	5	9,350	450	5	0.4	7,600	390	5	0.1
4020-0600		6	9,250	450	6	0.06	7,600	390	6	0.03
4020-0800		8	9,050	450	8	0.04	7,600	390	8	0.02
4020-1000		10	9,050	450	10	0.01	7,600	390	10	0.01
4025-0625	2.5	6.25	8,300	540	6.25	0.5	6,500	510	6.25	0.125
4025-1000		10	8,000	540	10	0.05	6,500	510	10	0.025
4030-0750	3	7.5	7,400	630	7.5	0.6	5,900	500	7.5	0.3
4030-0900		9	7,050	630	9	0.3	5,900	500	9	0.15
4030-1200		12	6,350	630	12	0.06	5,900	500	12	0.03
4030-1500		15	6,350	630	15	0.03	5,900	500	15	0.015
4035-0900	3.5	9	6,500	640	9	0.7	5,200	510	9	0.35
4040-1000	4	10	5,900	650	10	0.8	4,700	520	10	0.4
4040-1200		12	5,500	650	12	0.4	4,700	520	12	0.2
4040-1600		16	4,700	580	16	0.08	4,700	520	16	0.04
4040-2000		20	4,700	580	20	0.04	4,700	520	20	0.02
4045-1150	4.5	11.5	5,300	660	11.5	0.9	4,250	520	11.5	0.45
4050-1250	5	12.5	4,800	680	12.5	1	3,850	530	12.5	0.5
4050-1500		15	4,400	680	15	0.5	3,850	530	15	0.25
4050-2000		20	3,600	580	20	0.1	3,850	530	20	0.05
4050-2500		25	3,600	580	25	0.05	3,850	530	25	0.025
4055-1400	5.5	14	4,350	680	14	1.1	3,500	530	14	0.55
4060-1500	6	15	4,000	680	15	1.2	3,200	540	15	0.6
4060-1800		18	3,600	680	18	0.6	3,200	540	18	0.3
4060-2400		24	2,800	560	24	0.12	3,200	540	24	0.06
4060-3000		30	2,800	560	30	0.06	3,200	540	30	0.03
4065-1650	6.5	16.5	3,500	660	16.5	1.3	2,850	530	16.5	0.65

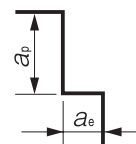

Side Milling
 a_p : Axial Depth (mm)
 a_e : Radial Depth (mm)

4 Flutes

UDC Series

CBN Series

Square

Long Neck Square

Radius

Long Neck Radius

Taper Neck Radius

Ball / Long Shank Ball

Long Neck Ball

Taper Neck Ball

Taper

Spiral V Cutter

Drill

EURO Series

Technical Data

Milling Conditions for CXES

Side Milling

WORK MATERIAL			CARBON STEELS S45C / S50C Annealed Materials (~225HB)				ALLOY STEELS SK / SCM Annealed Materials (225~325HB)				STAINLESS STEELS SUS304 Use water soluble or oil coolant.			
Model Number	Outside Diameter (mm)	Length of Cut (mm)	Spindle Speed (min ⁻¹)	Feed Rate (mm/min)	a_p Axial Depth (mm)	a_e Radial Depth (mm)	Spindle Speed (min ⁻¹)	Feed Rate (mm/min)	a_p Axial Depth (mm)	a_e Radial Depth (mm)	Spindle Speed (min ⁻¹)	Feed Rate (mm/min)	a_p Axial Depth (mm)	a_e Radial Depth (mm)
4070-1050	7	10.5	3,900	1,450	10.5	0.7	3,550	1,120	10.5	0.7	3,550	760	10.5	0.35
4070-1750		17.5	3,900	1,450	17.5	1.4	3,550	1,120	17.5	1.4	3,550	760	17.5	0.7
4075-1900	7.5	19	3,500	1,400	19	1.5	3,250	1,100	19	1.5	3,250	750	19	0.75
4080-2000	8	20	3,000	1,300	20	1.6	2,900	1,050	20	1.6	2,900	720	20	0.8
4080-2400		24	2,800	1,230	24	0.8	2,600	1,050	24	0.8	2,600	600	24	0.4
4080-3200		32	2,400	1,090	32	0.16	2,000	800	32	0.16	2,100	360	32	0.16
4080-4000		40	2,400	1,090	40	0.16	2,000	800	40	0.16	2,100	360	40	0.16
4085-2150	8.5	21.5	2,550	1,200	21.5	1.7	2,450	1,000	21.5	1.7	2,450	680	21.5	0.85
4090-1350	9	13.5	2,250	1,150	13.5	0.9	2,150	980	13.5	0.9	2,150	650	13.5	0.45
4090-2250		22.5	2,250	1,150	22.5	1.8	2,150	980	22.5	1.8	2,150	650	22.5	0.9
4095-2400	9.5	24	1,950	1,050	24	1.9	1,900	950	24	1.9	1,900	620	24	0.95
4100-2500	10	25	1,600	1,000	25	2	1,500	900	25	2	1,500	580	25	1
4100-3000		30	1,500	900	30	1	1,500	850	30	1	1,500	580	30	0.5
4100-4000		40	1,300	800	40	0.2	1,500	750	40	0.2	1,500	580	40	0.2
4100-5000		50	1,300	800	50	0.2	1,500	750	50	0.2	1,500	580	50	0.2
4110-1650	11	16.5	1,400	900	16.5	1.1	1,350	830	16.5	1.1	1,350	560	16.5	0.55
4110-2750		27.5	1,400	900	27.5	2.2	1,350	830	27.5	2.2	1,350	560	27.5	1.1
4120-3000	12	30	1,200	800	30	2.4	1,200	750	30	2.4	1,200	540	30	1.2
4120-3600		36	1,150	750	36	1.2	1,150	720	36	1.2	1,150	540	36	0.6
4120-4800		48	1,050	700	48	0.24	1,050	660	48	0.24	1,050	500	48	0.24
4120-6000		60	1,050	700	60	0.24	1,050	660	60	0.24	1,050	500	60	0.24
4130-1950	13	19.5	1,100	650	19.5	1.3	1,100	600	19.5	1.3	1,000	460	19.5	0.65
4160-4000	16	40	1,000	500	40	3.2	1,000	440	40	3.2	720	340	40	1.6

UDC Series

CBN Series

Square
Long Neck Square

Radius
Long Neck Radius
Taper Neck Radius

Ball / Long Shark Ball
Long Neck Ball
Taper Neck Ball

Taper

Spiral V Cutter

Drill

EURO Series

Technical Data

Milling Conditions for CXES

WORK MATERIAL			PREHARDENED STEELS HPM / NAK (30~45HRC)				HARDENED STEELS SKD / SKT / STAVAX (45~55HRC)			
Model Number	Outside Diameter (mm)	Length of Cut (mm)	Spindle Speed (min ⁻¹)	Feed Rate (mm/min)	a_p Axial Depth (mm)	a_e Radial Depth (mm)	Spindle Speed (min ⁻¹)	Feed Rate (mm/min)	a_p Axial Depth (mm)	a_e Radial Depth (mm)
4070-1050	7	10.5	3,150	640	10.5	0.7	2,550	520	10.5	0.35
4070-1750		17.5	3,150	640	17.5	1.4	2,550	520	17.5	0.7
4075-1900	7.5	19	2,850	620	19	1.5	2,250	510	19	0.75
4080-2000	8	20	2,500	600	20	1.6	2,000	500	20	0.8
4080-2400		24	2,350	600	24	0.8	2,150	500	24	0.4
4080-3200		32	2,050	530	32	0.16	2,150	400	32	0.08
4080-4000		40	2,050	530	40	0.08	2,150	400	40	0.04
4085-2150	8.5	21.5	2,150	550	21.5	1.7	1,700	490	21.5	0.85
4090-1350	9	13.5	1,950	520	13.5	0.9	1,500	480	13.5	0.45
4090-2250		22.5	1,950	520	22.5	1.8	1,500	480	22.5	0.9
4095-2400	9.5	24	1,750	480	24	1.9	1,350	470	24	0.95
4100-2500	10	25	1,500	430	25	2	1,200	450	25	1
4100-3000		30	1,500	430	30	1	1,200	450	30	0.5
4100-4000		40	1,500	430	40	0.2	1,200	450	40	0.1
4100-5000		50	1,500	430	50	0.1	1,200	450	50	0.05
4110-1650	11	16.5	1,250	380	16.5	1.1	1,060	430	16.5	0.55
4110-2750		27.5	1,250	380	27.5	2.2	1,060	430	27.5	1.1
4120-3000	12	30	1,000	320	30	2.4	960	420	30	1.2
4120-3600		36	1,000	320	36	1.2	930	400	36	0.6
4120-4800		48	1,000	320	48	0.24	870	360	48	0.12
4120-6000		60	1,000	320	60	0.12	870	360	60	0.06
4130-1950	13	19.5	1,000	260	19.5	1.3	890	350	19.5	0.65
4160-4000	16	40	1,000	220	40	3.2	720	280	40	1.6

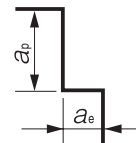

Side Milling
 a_p : Axial Depth (mm)
 a_e : Radial Depth (mm)

4 Flutes

UDC Series

CBN Series

Square

Long Neck Square

Radius

Radius

Long Neck Radius

Taper Neck Radius

Ball

Ball / Long Shank Ball

Long Neck Ball

Taper Neck Ball

Taper

Spiral V Cutter

Drill

EURO Series

Technical Data

Milling Conditions for CXES

Slotting

WORK MATERIAL			CARBON STEELS S45C / S50C Annealed Materials (~225HB)			ALLOY STEELS SK / SCM Annealed Materials (225~325HB)			STAINLESS STEELS SUS304 Use water soluble or oil coolant.		
Model Number	Outside Diameter (mm)	Length of Cut (mm)	Spindle Speed (min ⁻¹)	Feed Rate (mm/min)	a _p Axial Depth (mm)	Spindle Speed (min ⁻¹)	Feed Rate (mm/min)	a _p Axial Depth (mm)	Spindle Speed (min ⁻¹)	Feed Rate (mm/min)	a _p Axial Depth (mm)
4010-0250	1	2.5	18,000	200	1	18,000	200	1	14,500	220	0.5
4010-0300		3	18,000	190	0.5※	18,000	190	0.5※	14,300	210	0.25※
4010-0400		4	18,000	170	0.5※	18,000	170	0.5※	12,500	190	0.25※
4010-0500		5	18,000	170	0.5※	18,000	170	0.5※	12,500	190	0.25※
4015-0375	1.5	3.75	13,500	320	1.5	13,500	280	1.5	13,300	240	0.75
4015-0600		6	13,500	290	0.75※	13,500	250	0.75※	12,700	210	0.375※
4020-0500	2	5	11,000	460	2	11,000	320	2	12,200	260	1
4020-0600		6	11,000	440	1※	11,000	310	1※	12,000	240	0.5※
4020-0800		8	11,000	400	1※	11,000	290	1※	11,600	200	0.5※
4020-1000		10	11,000	400	1※	11,000	290	1※	11,600	200	0.5※
4025-0625	2.5	6.25	9,500	540	2.5	9,500	360	2.5	11,000	310	1.25
4025-1000		10	9,500	480	1.25※	9,500	330	1.25※	10,400	250	0.625※
4030-0750	3	7.5	8,500	600	3	8,500	400	3	10,000	360	1.5
4030-0900		9	8,500	550	3	8,500	360	3	9,100	310	1.5
4030-1200		12	8,500	450	1.5※	8,500	280	1.5※	7,300	210	0.75※
4030-1500		15	8,500	450	1.5※	8,500	280	1.5※	7,300	210	0.75※
4035-0900	3.5	9	7,800	620	3.5	7,500	420	3.5	8,600	380	1.75
4040-1000	4	10	7,200	650	4	6,700	450	4	7,500	400	2
4040-1200		12	7,200	580	4	6,700	400	4	6,600	320	2
4040-1600		16	7,200	440	2※	6,700	300	2※	4,800	200	1※
4040-2000		20	7,200	440	2※	6,700	300	2※	4,800	200	1※
4045-1150	4.5	11.5	6,550	670	4.5	6,000	470	4.5	6,300	430	2.25
4050-1250	5	12.5	6,000	700	5	5,400	500	5	5,400	460	2.5
4050-1500		15	6,000	600	5	5,400	430	5	4,600	350	2.5
4050-2000		20	6,000	400	2.5※	5,400	290	2.5※	3,000	170	1.25※
4050-2500		25	6,000	400	2.5※	5,400	290	2.5※	3,000	170	1.25※
4055-1400	5.5	14	5,450	700	5.5	4,900	500	5.5	4,900	460	2.75
Milling Amount (mm)			a _p =1D ※a _p =0.5D			a _p =1D ※a _p =0.5D			a _p =0.5D ※a _p =0.25D		

UDC Series

CBN Series

Square
Long Neck Square

Radius

Radius
Long Neck Radius
Taper Neck Radius

Ball / Long Shark Ball
Long Neck Ball

Taper

Spiral V Cutter

Drill

EURO Series

Technical Data

Milling Conditions for CXES

WORK MATERIAL			PREHARDENED STEELS HPM / NAK (30~45HRC)			HARDENED STEELS SKD / SKT / STAVAX (45~55HRC)		
Model Number	Outside Diameter (mm)	Length of Cut (mm)	Spindle Speed (min ⁻¹)	Feed Rate (mm/min)	a _p Axial Depth (mm)	Spindle Speed (min ⁻¹)	Feed Rate (mm/min)	a _p Axial Depth (mm)
4010-0250	1	2.5	12,900	130	1	12,900	50	0.3※
4010-0300		3	12,800	120	0.5※2	N/A	N/A	N/A
4010-0400		4	12,100	100	0.5※2	N/A	N/A	N/A
4010-0500		5	N/A	N/A	N/A	N/A	N/A	N/A
4015-0375	1.5	3.75	10,500	180	1.5	10,500	100	0.45※
4015-0600		6	10,200	150	0.75※2	N/A	N/A	N/A
4020-0500	2	5	9,350	220	2	9,350	150	0.6※
4020-0600		6	9,300	200	1※2	N/A	N/A	N/A
4020-0800		8	8,600	160	1※2	N/A	N/A	N/A
4020-1000		10	N/A	N/A	N/A	N/A	N/A	N/A
4025-0625	2.5	6.25	8,300	270	2.5	8,300	240	0.75※
4025-1000		10	8,000	210	1.25※2	N/A	N/A	N/A
4030-0750	3	7.5	7,400	320	3	7,400	360	1.5
4030-0900		9	7,050	270	3	N/A	N/A	N/A
4030-1200		12	6,350	170	1.5※2	N/A	N/A	N/A
4030-1500		15	N/A	N/A	N/A	N/A	N/A	N/A
4035-0900	3.5	9	6,500	350	3.5	6,500	370	1.75
4040-1000	4	10	5,900	390	4	5,900	380	2
4040-1200		12	5,500	300	4	N/A	N/A	N/A
4040-1600		16	4,700	160	2※2	N/A	N/A	N/A
4040-2000		20	N/A	N/A	N/A	N/A	N/A	N/A
4045-1150	4.5	11.5	5,300	410	4.5	5,300	390	2.25
4050-1250	5	12.5	4,800	440	5	4,800	410	2.5
4050-1500		15	4,400	320	5	N/A	N/A	N/A
4050-2000		20	3,600	160	2.5※2	N/A	N/A	N/A
4050-2500		25	N/A	N/A	N/A	N/A	N/A	N/A
4055-1400	5.5	14	4,350	440	5.5	4,350	420	2.75
Milling Amount (mm)			※1 a _p =1D ※2 a _p =0.8D ※3 a _p =0.5D			※1 a _p =0.5D ※2 a _p =0.3D		

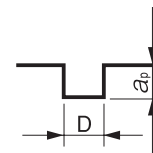

Slotting
 a_p : Axial Depth (mm)
 D : Outside Diameter (mm)

4 Flutes

UDC Series

CBN Series

Square

Long Neck Square

Radius

Radius

Long Neck Radius
Taper Neck Radius

Ball

Ball / Long Shank Ball
Long Neck Ball
Taper Neck Ball

Taper

Taper

Spiral V Cutter

Spiral V Cutter

Drill

Drill

EURO Series

EURO Series

Technical Data

Technical Data

Milling Conditions for CXES

Slotting

WORK MATERIAL			CARBON STEELS S45C / S50C Annealed Materials (~225HB)			ALLOY STEELS SK / SCM Annealed Materials (225~325HB)			STAINLESS STEELS SUS304 Use water soluble or oil coolant.		
Model Number	Outside Diameter (mm)	Length of Cut (mm)	Spindle Speed (min ⁻¹)	Feed Rate (mm/min)	a _p Axial Depth (mm)	Spindle Speed (min ⁻¹)	Feed Rate (mm/min)	a _p Axial Depth (mm)	Spindle Speed (min ⁻¹)	Feed Rate (mm/min)	a _p Axial Depth (mm)
4060-1500	6	15	5,000	700	6	4,500	500	6	4,500	460	3
4060-1800		18	5,000	560	6	4,500	410	6	3,700	320	3
4060-2400		24	5,000	280	3※	4,500	230	3※	2,100	150	1.5※
4060-3000		30	5,000	280	3※	4,500	230	3※	2,100	150	1.5※
4065-1650	6.5	16.5	4,400	650	6.5	3,950	450	6.5	3,950	420	3.25
4070-1050	7	10.5	3,900	300	7	3,550	200	7	3,550	200	3.5
4070-1750		17.5	3,900	600	7	3,550	400	7	3,550	390	3.5
4075-1900	7.5	19	3,500	550	7.5	3,250	380	7.5	3,250	380	3.75
4080-2000	8	20	3,000	500	8	2,900	360	8	2,900	360	4
4080-2400		24	2,800	330	8	2,600	260	8	2,600	240	4
4080-3200		32	2,400	230	4※	2,000	180	4※	2,000	130	2※
4080-4000		40	2,400	230	4※	2,000	180	4※	2,000	130	2※
4085-2150	8.5	21.5	2,550	450	8.5	2,450	330	8.5	2,450	310	4.25
4090-1350	9	13.5	2,250	210	9	2,150	160	9	2,150	140	4.5
4090-2250		22.5	2,250	420	9	2,150	300	9	2,150	260	4.5
4095-2400	9.5	24	1,950	400	9.5	1,900	300	9.5	1,900	250	4.75
4100-2500	10	25	1,600	380	10	1,500	270	10	1,500	220	5
4100-3000		30	1,500	250	10	1,500	180	10	1,500	190	5
4100-4000		40	1,300	180	5※	1,500	150	5※	1,500	130	2.5※
4100-5000		50	1,300	180	5※	1,500	150	5※	1,500	130	2.5※
4110-1650	11	16.5	1,400	170	11	1,350	120	11	1,350	100	5.5
4110-2750		27.5	1,400	340	11	1,350	240	11	1,350	200	5.5
4120-3000	12	30	1,200	300	12	1,200	210	12	1,200	180	6
4120-3600		36	1,150	200	12	1,150	140	12	1,150	150	6
4120-4800		48	1,050	160	6※	1,050	120	6※	1,050	100	3※
4120-6000		60	1,050	160	6※	1,050	120	6※	1,050	100	3※
4130-1950	13	19.5	1,100	190	13	1,100	90	13	1,000	80	6.5
4160-4000	16	40	1,000	400	8※	1,000	280	8※	720	240	4※
Milling Amount (mm)			a _p =1D ※a _p =0.5D			a _p =1D ※a _p =0.5D			a _p =0.5D ※a _p =0.25D		

UDC Series

CBN Series

Square
Long Neck Square

Radius
Long Neck Radius
Taper Neck Radius

Ball / Long Shark Ball
Long Neck Ball
Taper Neck Ball

Taper

Spiral V Cutter

Drill

EURO Series

Technical Data

Milling Conditions for CXES

WORK MATERIAL			PREHARDENED STEELS HPM / NAK (30~45HRC)			HARDENED STEELS SKD / SKT / STAVAX (45~55HRC)		
Model Number	Outside Diameter (mm)	Length of Cut (mm)	Spindle Speed (min ⁻¹)	Feed Rate (mm/min)	a _p Axial Depth (mm)	Spindle Speed (min ⁻¹)	Feed Rate (mm/min)	a _p Axial Depth (mm)
4060-1500	6	15	4,000	440	6	4,000	440	3
4060-1800		18	3,600	290	6	N/A	N/A	N/A
4060-2400		24	2,800	140	3*2	N/A	N/A	N/A
4060-3000		30	N/A	N/A	N/A	N/A	N/A	N/A
4065-1650	6.5	16.5	3,500	420	6.5	3,500	400	3.25
4070-1050	7	10.5	3,150	190	7	3,150	190	3.5
4070-1750		17.5	3,150	410	7	3,150	380	3.5
4075-1900	7.5	19	2,850	400	7.5	2,850	370	3.75
4080-2000	8	20	2,500	390	8	2,500	340	4
4080-2400		24	2,350	200	8	N/A	N/A	N/A
4080-3200		32	2,050	110	4*2	N/A	N/A	N/A
4080-4000		40	N/A	N/A	N/A	N/A	N/A	N/A
4085-2150	8.5	21.5	2,150	330	8.5	2,150	300	4.25
4090-1350	9	13.5	1,950	150	9	1,950	140	4.5
4090-2250		22.5	1,950	300	9	1,950	270	4.5
4095-2400	9.5	24	1,750	270	9.5	1,750	270	4.75
4100-2500	10	25	1,500	220	10	1,500	240	5
4100-3000		30	1,500	180	8*1	N/A	N/A	N/A
4100-4000		40	1,200	90	5*2	N/A	N/A	N/A
4100-5000		50	N/A	N/A	N/A	N/A	N/A	N/A
4110-1650	11	16.5	1,250	100	11	1,350	110	5.5
4110-2750		27.5	1,250	200	11	1,350	230	5.5
4120-3000	12	30	1,000	180	12	1,200	220	6
4120-3600		36	1,000	140	9.6*1	N/A	N/A	N/A
4120-4800		48	800	70	6*2	N/A	N/A	N/A
4120-6000		60	N/A	N/A	N/A	N/A	N/A	N/A
4130-1950	13	19.5	1,000	80	13	1,100	90	6.5
4160-4000	16	40	1,000	240	8*2	1,000	220	4.8**
Milling Amount (mm)			a _p =1D ※1 a _p =0.8D ※2 a _p =0.5D			a _p =0.5D ※ a _p =0.3D		

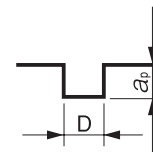

Slotting
 a_p : Axial Depth (mm)
 D : Outside Diameter (mm)

4 Flutes

UDC Series

CBN Series

Square
 Long Neck Square

Radius

Radius
 Long Neck Radius

Taper Neck Radius

Ball / Long Shank Ball
 Long Neck Ball

Taper Neck Ball

Taper
 Taper

Spiral V Cutter

Drill

EURO Series

Technical Data

Note:

- Decrease both spindle speed and feed rate proportionally in case of chattering.
- These milling parameters are calculated based on the shortest overhang length. Longer overhangs may require an adjustment to the milling parameters.
- Reduce the milling amount and feed rate in accordance with required milling precision.
- Every coolant offers stable milling.
- Recommend water soluble or oil coolant for Stainless Steels and Copper.

UDC Series

CBN Series

Square
Square
Long Neck Square

Radius
Radius
Long Neck Radius
Taper Neck Radius

Ball / Long Shank Ball
Ball
Long Neck Ball
Taper Neck Ball

Taper
Taper

Spiral V Cutter

Drill

EURO Series

Technical Data

Milling Example CXES ϕ 10

S55C

Roughing and finishing with a single tool

Size : 105 mm \times 92 mm \times 20 mm

Tool	Roughing		Finishing	
	Conventional 4 Flutes	CXES 4100-2500	CXES 4100-2500	
Milling Part	Side / Groove		Bottom	Side
Spindle Speed	2,600 min ⁻¹	2,500 min ⁻¹	1,600 min ⁻¹	
Feed Rate	525 mm/min	1,500 mm/min	380 mm/min	1,000 mm/min
Axial Depth a_p	20 mm	19.9 mm	0.1 mm	0.1 mm
Radial Depth a_e	0.7 mm	1.2 mm	0.4 mm	0.1 mm
Coolant	Oil		Oil	
Milling Distance	—	11.5 m	1.5 m	0.7 m
Efficiency *	1	4.8	—	

* Efficiency : Feed Rate \times Axial Depth \times Radial Depth

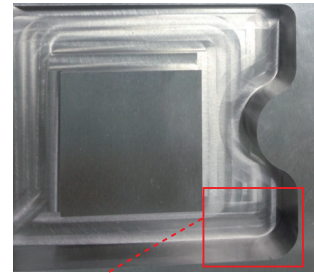

Enlarged view

4.8 times milling efficiency compared to conventional 4 flutes when roughing

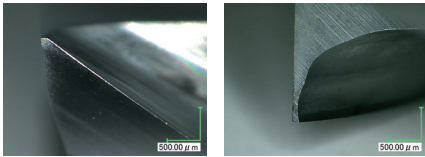

Total Milling Distance 21 m

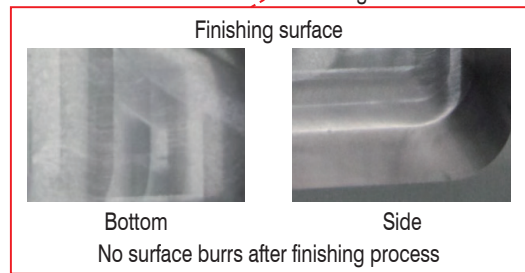

Milling Example CXES ϕ 6

SUS304

Tool	CXES4060-1500	
	Roughing	Finishing
Milling Method	Roughing	Finishing
Spindle Speed	4,500 min ⁻¹	4,500 min ⁻¹
Feed Rate	810 mm/min	400 mm/min
Axial Depth a_p	15 mm	15 mm
Radial Depth a_e	0.6 mm	2.5 mm (Standing Wall Finishing Allowance 0.1mm)
Overhang Length	20 mm	20 mm
Coolant	Water Soluble (Through Spindle)	Water Soluble (Through Spindle)
Cycle Time	1:11:29	0:18:43

CXES Milling Video

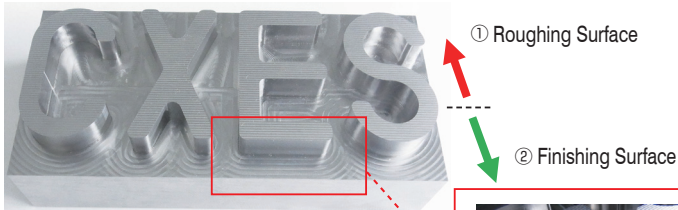

Enlarged view

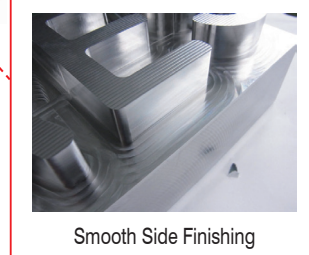

Tool Wearing after Roughing Process

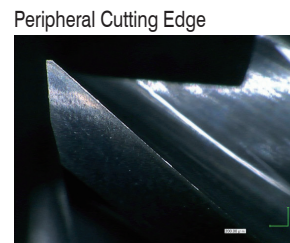
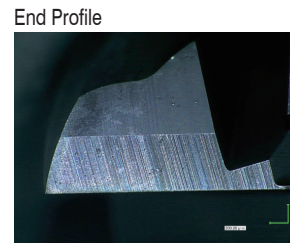

4 Flutes

UDC Series

CBN Series

Square

Long Neck Square

Radius

Radius

Long Neck Radius

Taper Neck Radius

Ball / Long Shank Ball

Ball

Long Neck Ball

Taper Neck Ball

Taper

Taper

Spiral V Cutter

Drill

EURO Series

Technical Data



Size $\phi 1 \sim \phi 20$

C-CES4000



Material Applications (☆ Highly Recommended ○ Recommended ○ Suggested)

Work Material															
Carbon Steels S45C S55C	Alloy Steels SK / SCM SUS	Prehardened Steels NAK HPM	Hardened Steels			Cast Iron	Aluminum Alloys	Graphite	Copper	Plastics	Glass Filled Plastics	Titanium Alloys	Heat Resistant Alloys	Cemented Carbide	Hard Brittle (Non-Metallic) Materials
			~55HRC	~60HRC	~70HRC										
○	○	○	○			○			○				○	○	

Features

**Broad application range from Copper and Carbon Steels up to Hardened Steels (55HRC).
Excellent performance/quality to price ratio.
Refer to page 154 for 2 flute C-CES.**

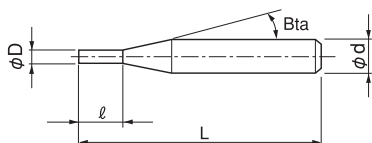

The shank taper angle shown is not an exact value and to avoid contact with the work piece, we recommend the user controls the precise value of this angle. Shank taper angle should not make contact with the work piece. Actual measurement is necessary when using longer length of cut than the written length.

Total 56 models

Unit (mm)

Model Number	Outside Diameter ϕD	Length of Cut ℓ	Shank Taper Angle Bta	Overall Length L	Shank Diameter ϕd	Price \yen
C-CES 4010	1	2.5	16°	45	4	5,160
C-CES 4010-0300		3		45	4	5,160
C-CES 4010-0400		4		45	4	5,400
C-CES 4015	1.5	3.75	16°	45	4	5,160
C-CES 4015-0450		4.5		45	4	5,160
C-CES 4015-0600		6		45	4	5,400
C-CES 4020	2	5	16°	45	4	3,300
C-CES 4020-0600		6		45	4	3,300
C-CES 4020-0800		8		45	4	4,440
C-CES 4025	2.5	6.25	16°	45	4	3,300
C-CES 4025-0750		7.5		50	4	3,300
C-CES 4025-1000		10		50	4	4,440
C-CES 4030-0750	3	7.5	16°	45	6	3,420
C-CES 4030		8		45	6	3,420
C-CES 4030-0900		9		50	6	3,420
C-CES 4030-1200		12		50	6	4,320
C-CES 4035		10		45	6	7,150

Unit (mm)

Model Number	Outside Diameter ϕD	Length of Cut ℓ	Shank Taper Angle Bta	Overall Length L	Shank Diameter ϕd	Price ¥
C-CES 4040	4	11	16°	45	6	3,860
C-CES 4040-1200		12		60	6	3,860
C-CES 4040-1600		16		60	6	5,160
C-CES 4045	4.5	11	16°	45	6	8,400
C-CES 4050-1250	5	12.5	16°	50	6	3,970
C-CES 4050		13		50	6	3,970
C-CES 4050-1500		15		60	6	3,970
C-CES 4050-2000		20		60	6	5,520
C-CES 4055	5.5	13	16°	50	6	8,610
C-CES 4060	6	13	—	50	6	4,170
C-CES 4060-1500		15		50	6	4,170
C-CES 4060-1800		18		60	6	4,170
C-CES 4060-2400		24		60	6	6,000
C-CES 4065	6.5	16	16°	60	8	11,660
C-CES 4070	7	16	16°	60	8	10,360
C-CES 4075	7.5	16	16°	60	8	12,540
C-CES 4080	8	19	—	60	8	7,090
C-CES 4080-2000		20		60	8	7,090
C-CES 4080-2400		24		80	8	7,090
C-CES 4080-3200		32		80	8	15,000
C-CES 4085	8.5	19	16°	70	10	15,180
C-CES 4090	9	19	16°	70	10	13,650
C-CES 4095	9.5	19	16°	70	10	17,160
C-CES 4100	10	22	—	70	10	9,460
C-CES 4100-2500		25		70	10	9,460
C-CES 4100-3000		30		90	10	9,460
C-CES 4100-4000		40		90	10	16,560
C-CES 4105	10.5	22	16°	75	12	20,900
C-CES 4110	11	22	16°	75	12	20,900
C-CES 4115	11.5	22	16°	75	12	22,440
C-CES 4120	12	26	—	75	12	11,880
C-CES 4120-3000		30		75	12	11,880
C-CES 4120-3600		36		90	12	11,880
C-CES 4120-4800		48		100	12	25,200
C-CES 4120-5000		50		100	12	25,200
C-CES 4140	14	26	—	80	12	29,150
C-CES 4160	16	32	—	110	16	46,200
C-CES 4180	18	32	16°	110	20	62,150
C-CES 4200	20	38	—	110	20	68,200

4 Flutes

UDC Series

CBN Series

Square

Long Neck Square

Radius

Radius

Long Neck Radius

Taper Neck Radius

Ball

Ball / Long Shank Ball

Long Neck Ball

Taper Neck Ball

Taper

Spiral V Cutter

Drill

EURO Series

Technical Data

Milling Conditions for C-CES (4 Flutes)

WORK MATERIAL			CARBON STEELS S45C / S50C (~225HB)				ALLOY STEELS SK / SCM / SUS (225~325HB)			
			Side Milling				Side Milling			
Model Number	Outside Diameter (mm)	Length of Cut (mm)	Spindle Speed (min ⁻¹)	Feed Rate (mm/min)	a _{ax} Axial Depth (mm)	a _{re} Radial Depth (mm)	Spindle Speed (min ⁻¹)	Feed Rate (mm/min)	a _{ax} Axial Depth (mm)	a _{re} Radial Depth (mm)
4010	1	2.5	20,000	240	2	0.07	15,000	215	2	0.07
		3			2.5	0.05			2.5	0.05
		4			3.5	0.02			3.5	0.02
4015	1.5	3.75	13,500	245	3	0.105	10,000	215	3	0.105
		4.5			3.75	0.075			3.75	0.075
		6			5.25	0.03			5.25	0.03
4020	2	5	11,000	245	4	0.14	8,500	215	4	0.14
		6			5	0.1			5	0.1
		8			7	0.04			7	0.04
4025	2.5	6.25	8,800	370	5	0.175	7,000	245	5	0.175
		7.5			6.25	0.125			6.25	0.125
		10			8.75	0.05			8.75	0.05
4030	3	7.5	7,400	370	6	0.21	6,400	260	6	0.21
		8			7.5	0.15			7.5	0.15
		9			7.5	0.15			7.5	0.15
		12			10.5	0.06			10.5	0.06
4040	4	11	5,900	435	10	0.2	5,000	340	10	0.2
		12			10	0.2			10	0.2
		16			14	0.08			14	0.08
4050	5	12.5	5,300	590	10	0.35	4,200	415	10	0.35
		13			12.5	0.25			12.5	0.25
		15			12.5	0.25			12.5	0.25
		20			17.5	0.1			17.5	0.1
4060	6	13	4,400	580	12	0.42	3,500	415	12	0.42
		15			12	0.42			12	0.42
		18			15	0.3			15	0.3
		24			21	0.12			21	0.12
4080	8	19	3,300	550	16	0.56	2,600	415	16	0.56
		20			16	0.56			16	0.56
		24			20	0.4			20	0.4
		32			28	0.16			28	0.16
4100	10	22	2,600	525	20	0.7	2,100	405	20	0.7
		25			20	0.7			20	0.7
		30			25	0.5			25	0.5
		40			35	0.2			35	0.2
4120	12	26	2,200	525	24	0.84	1,750	405	24	0.84
		30			24	0.84			24	0.84
		36			30	0.6			30	0.6
		48			42	0.24			42	0.24
		50			42	0.24			42	0.24

UDC Series

CBN Series

Square
Long Neck Square

Radius
Long Neck Radius
Taper Neck Radius

Ball / Long Shank Ball
Long Neck Ball

Taper

Spiral V Cutter

Drill

EURO Series

Technical Data

Milling Conditions for C-CES (4 Flutes)

WORK MATERIAL			PREHARDENED STEELS / HARDENED STEELS NAK / SKD (30~45HRC)				HARDENED STEELS SKD / SKT (45~55HRC)			
			Side Milling				Side Milling			
Model Number	Outside Diameter (mm)	Length of Cut (mm)	Spindle Speed (min ⁻¹)	Feed Rate (mm/min)	a ₀ Axial Depth (mm)	a _e Radial Depth (mm)	Spindle Speed (min ⁻¹)	Feed Rate (mm/min)	a ₀ Axial Depth (mm)	a _e Radial Depth (mm)
4010	1	2.5	11,000	85	2	0.07	7,100	40	1.5	0.03
		3			2.5	0.05			2	0.02
		4			3.5	0.02			3	0.01
4015	1.5	3.75	8,000	90	3	0.105	5,100	50	2.25	0.045
		4.5			3.75	0.075			3	0.03
		6			5.25	0.03			4.5	0.015
4020	2	5	6,400	90	4	0.14	4,000	55	3	0.06
		6			5	0.1			4	0.04
		8			7	0.04			6	0.02
4025	2.5	6.25	5,000	90	5	0.175	3,200	55	3.75	0.075
		7.5			6.25	0.125			5	0.05
		10			8.75	0.05			7.5	0.025
4030	3	7.5	4,500	105	6	0.21	2,800	65	4.5	0.09
		8			7.5	0.15			6	0.06
		9			7.5	0.15			6	0.06
		12			10.5	0.06			9	0.03
4040	4	11	3,500	120	10	0.2	2,150	70	8	0.08
		12			10	0.2			8	0.08
		16			14	0.08			12	0.04
4050	5	12.5	2,950	120	10	0.35	1,850	75	7.5	0.15
		13			12.5	0.25			10	0.1
		15			12.5	0.25			10	0.1
		20			17.5	0.1			15	0.05
4060	6	13	2,450	130	12	0.42	1,500	70	9	0.18
		15			12	0.42			9	0.18
		18			15	0.3			12	0.12
		24			21	0.12			18	0.06
4080	8	19	1,850	125	16	0.56	1,200	70	12	0.24
		20			16	0.56			12	0.24
		24			20	0.4			16	0.16
		32			28	0.16			24	0.08
4100	10	22	1,450	125	20	0.7	950	65	15	0.3
		25			20	0.7			15	0.3
		30			25	0.5			20	0.2
		40			35	0.2			30	0.1
4120	12	26	1,200	120	24	0.84	800	60	18	0.36
		30			24	0.84			18	0.36
		36			30	0.6			24	0.24
		48			42	0.24			36	0.12
		50			42	0.24			36	0.12

4 Flutes

UDC Series

CBN Series

Square

Long Neck Square

Radius

Long Neck Radius

Taper Neck Radius

Ball / Long Shank Ball

Long Neck Ball

Taper Neck Ball

Taper

Spiral V Cutter

Drill

EURO Series

Technical Data

Milling Conditions for C-CES (4 Flutes)

◆High speed milling

WORK MATERIAL			CARBON STEELS S45C / S50C (~225HB)				ALLOY STEELS SK / SCM / SUS (225~325HB)			
			Side Milling				Side Milling			
Model Number	Outside Diameter (mm)	Length of Cut (mm)	Spindle Speed (min ⁻¹)	Feed Rate (mm/min)	a _{ax} Axial Depth (mm)	a _{ar} Radial Depth (mm)	Spindle Speed (min ⁻¹)	Feed Rate (mm/min)	a _{ax} Axial Depth (mm)	a _{ar} Radial Depth (mm)
4030	3	7.5	30,000	1,500	6	0.21	26,500	1,075	6	0.21
		8			7.5	0.15			7.5	0.15
		9			7.5	0.15			7.5	0.15
		12			10.5	0.06			10.5	0.06
4040	4	11	23,800	1,755	10	0.2	19,800	1,345	10	0.2
		12			10	0.2			10	0.2
		16			14	0.08			14	0.08
4050	5	12.5	19,000	2,115	10	0.35	15,800	1,560	10	0.35
		13			12.5	0.25			12.5	0.25
		15			12.5	0.25			12.5	0.25
		20			17.5	0.1			17.5	0.1
4060	6	13	15,900	2,095	12	0.42	13,200	1,565	12	0.42
		15			12	0.42			12	0.42
		18			15	0.3			15	0.3
		24			21	0.12			21	0.12
4080	8	19	11,900	1,985	16	0.56	9,900	1,580	16	0.56
		20			16	0.56			16	0.56
		24			20	0.4			20	0.4
		32			28	0.16			28	0.16
4100	10	22	9,500	1,920	20	0.7	7,900	1,525	20	0.7
		25			20	0.7			20	0.7
		30			25	0.5			25	0.5
		40			35	0.2			35	0.2
4120	12	26	7,900	1,885	24	0.84	6,600	1,525	24	0.84
		30			24	0.84			24	0.84
		36			30	0.6			30	0.6
		48			42	0.24			42	0.24
		50			42	0.24			42	0.24

UDC Series

CBN Series

Square
Long Neck Square

Radius

Long Neck Radius
Taper Neck Radius

Ball / Long Shank Ball

Long Neck Ball
Taper Neck Ball

Taper

Spiral V Cutter

Drill

EURO Series

Technical Data

Milling Conditions for C-CES (4 Flutes)

WORK MATERIAL			PREHARDENED STEELS / HARDENED STEELS NAK / SKD (30~45HRC)				HARDENED STEELS SKD / SKT (45~55HRC)			
			Side Milling				Side Milling			
Model Number	Outside Diameter (mm)	Length of Cut (mm)	Spindle Speed (min ⁻¹)	Feed Rate (mm/min)	a _p Axial Depth (mm)	a _e Radial Depth (mm)	Spindle Speed (min ⁻¹)	Feed Rate (mm/min)	a _p Axial Depth (mm)	a _e Radial Depth (mm)
4030	3	7.5	21,200	495	6	0.21	15,800	365	4.5	0.09
		8			7.5	0.15			6	0.06
		9			7.5	0.15			6	0.06
		12			10.5	0.06			9	0.03
4040	4	11	15,800	540	10	0.2	11,900	385	8	0.08
		12			10	0.2			8	0.08
		16			14	0.08			12	0.04
4050	5	12.5	12,700	515	10	0.35	9,500	385	7.5	0.15
		13			12.5	0.25			10	0.1
		15			12.5	0.25			10	0.1
		20			17.5	0.1			15	0.05
4060	6	13	10,600	560	12	0.42	7,900	370	9	0.18
		15			12	0.42			9	0.18
		18			15	0.3			12	0.12
		24			21	0.12			18	0.06
4080	8	19	7,900	535	16	0.56	5,900	345	12	0.24
		20			16	0.56			12	0.24
		24			20	0.4			16	0.16
		32			28	0.16			24	0.08
4100	10	22	6,300	545	20	0.7	4,700	320	15	0.3
		25			20	0.7			15	0.3
		30			25	0.5			20	0.2
		40			35	0.2			30	0.1
4120	12	26	5,300	530	24	0.84	3,900	295	18	0.36
		30			24	0.84			18	0.36
		36			30	0.6			24	0.24
		48			42	0.24			36	0.12
		50			42	0.24			36	0.12

Milling amount (mm)

Work Material	Length of Cut		
	2.5D or below	3D or below	4D or above
45HRC or below	a _p =2D a _e =0.07D	a _p =2.5D a _e =0.05D	a _p =3.5D a _e =0.02D
45HRC or above	a _p =1.5D a _e =0.03D	a _p =2D a _e =0.02D	a _p =3D a _e =0.01D

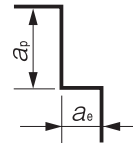

D : Outside Diameter (mm)

Ex.) 2D or below : Flute Length = Diameter × 2 or below

a_p : Axial Depth (mm)

a_e : Radial Depth (mm)

Note:

- Recommend water soluble or oil coolant.
- Recommend oil coolant for Titanium Alloys and Heat Resistant Alloys.

4 Flutes

UDC Series

CBN Series

Square

Long Neck Square

Radius

Long Neck Radius

Taper Neck Radius

Ball / Long Shank Ball

Long Neck Ball

Taper Neck Ball

Taper

Spiral V Cutter

Drill

EURO Series

Technical Data



Size $\phi 1 \sim \phi 12$

C-CES4000S



Material Applications (☆ Highly Recommended ○ Recommended ○ Suggested)

Work Material															
Carbon Steels S45C S55C	Alloy Steels SK / SCM SUS	Prehardened Steels NAK HPM	Hardened Steels			Cast Iron	Aluminum Alloys	Graphite	Copper	Plastics	Glass Filled Plastics	Titanium Alloys	Heat Resistant Alloys	Cemented Carbide	Hard Brittle (Non-Metallic) Materials
			~55HRC	~60HRC	~70HRC										
○	○	○	○			○			○			○	○		

Features

4 flute C-CES with a sharp corner design.
Broad application range from Copper and Carbon Steels up to Hardened Steels (55HRC).
Excellent performance / quality to price ratio.
Refer to page 168 for 2 flute C-CES-S.

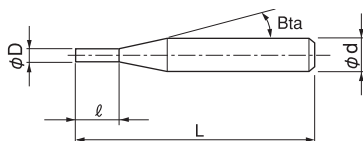

The shank taper angle shown is not an exact value and to avoid contact with the work piece, we recommend the user controls the precise value of this angle. Shank taper angle should not make contact with the work piece.

Length of Cut for C-CES 4020S has been changed from 5 mm to 6 mm.
 Change Date: from production in November 2012.

Total 11 models

Unit (mm)

Model Number	Outside Diameter ϕD	Length of Cut ℓ	Shank Taper Angle B_{ta}	Overall Length L	Shank Diameter ϕd	Price ¥
C-CES 4010S	1	2.5	16°	45	4	5,160
C-CES 4015S	1.5	3.75	16°	45	4	5,160
C-CES 4020S	2	6	16°	45	4	3,300
C-CES 4025S	2.5	6.25	16°	45	4	3,300
C-CES 4030S	3	8	16°	45	6	3,420
C-CES 4040S	4	11	16°	45	6	3,860
C-CES 4050S	5	13	16°	50	6	3,970
C-CES 4060S	6	13	—	50	6	4,170
C-CES 4080S	8	19	—	60	8	7,090
C-CES 4100S	10	22	—	70	10	9,460
C-CES 4120S	12	26	—	75	12	11,880

Milling Conditions for C-CES-S (4 Flutes)

WORK MATERIAL		CARBON STEELS S45C / S50C (~225HB)				ALLOY STEELS SK / SCM / SUS (225~325HB)			
		Side Milling				Side Milling			
Model Number	Outside Diameter (mm)	Spindle Speed (min ⁻¹)	Feed Rate (mm/min)	a_p Axial Depth (mm)	a_e Radial Depth (mm)	Spindle Speed (min ⁻¹)	Feed Rate (mm/min)	a_p Axial Depth (mm)	a_e Radial Depth (mm)
4010S	1	20,000	170	2	0.07	13,700	150	2	0.07
4015S	1.5	13,400	190	3	0.105	9,100	160	3	0.105
4020S	2	11,600	200	4	0.14	5,600	170	4	0.14
4025S	2.5	9,300	300	5	0.175	4,200	190	5	0.175
4030S	3	8,800	340	6	0.21	6,700	210	6	0.21
4040S	4	6,600	370	8	0.28	5,000	270	8	0.28
4050S	5	5,300	450	10	0.35	4,000	320	10	0.35
4060S	6	4,400	450	12	0.42	3,300	320	12	0.42
4080S	8	3,300	420	16	0.56	2,500	300	16	0.56
4100S	10	2,650	410	20	0.7	2,000	300	20	0.7
4120S	12	2,200	400	24	0.84	1,700	300	24	0.84

WORK MATERIAL		PREHARDENED STEELS / HARDENED STEELS NAK / SKD (30~45HRC)				HARDENED STEELS SKD / SKT (45~55HRC)			
		Side Milling				Side Milling			
Model Number	Outside Diameter (mm)	Spindle Speed (min ⁻¹)	Feed Rate (mm/min)	a_p Axial Depth (mm)	a_e Radial Depth (mm)	Spindle Speed (min ⁻¹)	Feed Rate (mm/min)	a_p Axial Depth (mm)	a_e Radial Depth (mm)
4010S	1	7,300	55	2	0.07	1,600	15	1.5	0.03
4015S	1.5	4,900	60	3	0.105	1,100	15	2.25	0.045
4020S	2	5,300	65	4	0.14	2,400	30	3	0.06
4025S	2.5	4,200	70	5	0.175	1,900	35	3.75	0.075
4030S	3	4,600	90	6	0.21	2,700	50	4.5	0.09
4040S	4	3,400	100	8	0.28	2,000	55	6	0.12
4050S	5	2,700	110	10	0.35	1,600	60	7.5	0.15
4060S	6	2,300	110	12	0.42	1,300	60	9	0.18
4080S	8	1,700	100	16	0.56	1,000	50	12	0.24
4100S	10	1,400	100	20	0.7	800	50	15	0.3
4120S	12	1,150	90	24	0.84	700	45	18	0.36

Milling Amount for side milling (mm)

45HRC or below	$a_p=2D$ $a_e=0.07D$
45HRC or above	$a_p=1.5D$ $a_e=0.03D$

D : Outside Diameter (mm)

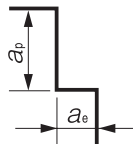

a_p : Axial Depth (mm)

a_e : Radial Depth (mm)

Note:

- Recommend water soluble or oil coolant.
- Recommend oil coolant for Titanium Alloys and Heat Resistant Alloys.

4 Flutes

UDC Series

CBN Series

Square

Long Neck Square

Radius

Long Neck Radius

Taper Neck Radius

Ball / Long Shank Ball

Long Neck Ball

Taper Neck Ball

Taper

Spiral V Cutter

Drill

EURO Series

Technical Data



Size $\phi 6 \sim \phi 12$

CESUS



Material Applications (☆ Highly Recommended ○ Recommended ○ Suggested)

Work Material															
Carbon Steels	Alloy Steels	Prehardened Steels	Hardened Steels			Cast Iron	Aluminum Alloys	Graphite	Copper	Plastics	Glass Filled Plastics	Titanium Alloys	Heat Resistant Alloys	Cemented Carbide	Hard Brittle (Non-Metallic) Materials
S45C	SK / SCM	NAK	~55HRC	~60HRC	~70HRC										
S55C	SUS	HPM													
○	☆	○				○			○			○	○		

Features

4 Flute Highly Efficient Square End Mills for stainless steels.

Variable pitch & variable helix designed for milling stainless steels offers higher efficiency milling. New coating 'UTSCOAT' with excellent adhesion offers high resistance to breakage.

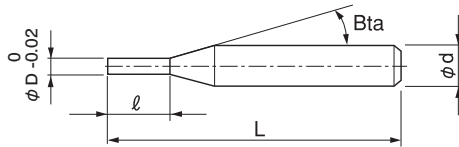

The shank taper angle shown is not an exact value and to avoid contact with the workpiece, we recommend the user controls the precise value of this angle. Shank taper angle should not make contact with the work piece.

Design features

Variable pitch & variable helix designed for milling stainless steels.

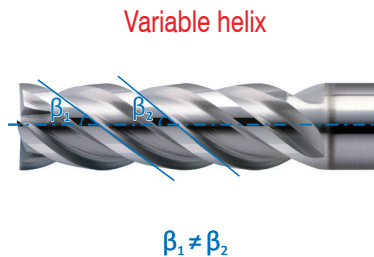
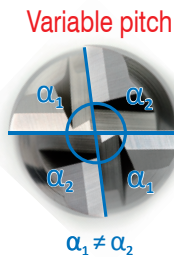

Minimizes chattering

Stable milling under highly efficient conditions

Features of UTSCOAT

Improve the resistance to adhesion by adding a highly lubricant layer onto the high hardness and high toughness UTSCOAT.

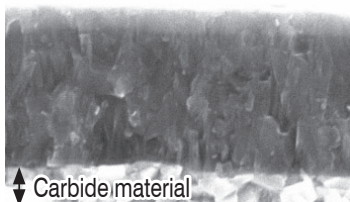

- ★ Ultra lubricant layer
- ◆ Ultra hard layer
- ◆ High toughness and adhesion layer

◆ Carbide material

Reduce adhesion

High resistance to breakage with high lubricity

Total 21 models

Unit (mm)

Model Number	Outside Diameter ϕD	Length of Cut ℓ	Shank Taper Angle Bta	Overall Length L	Shank Diameter ϕd	Price ¥
CESUS 4060-0900	6	9	—	60	6	8,500
CESUS 4060-1300		13		60	6	8,500
CESUS 4060-1800		18		60	6	9,350
CESUS 4070-1050	7	10.5	16°	70	8	10,500
CESUS 4070-1600		16		70	8	10,500
CESUS 4070-2100		21		70	8	11,550
CESUS 4080-1200	8	12	—	70	8	10,500
CESUS 4080-1900		19		70	8	10,500
CESUS 4080-2400		24		70	8	11,550
CESUS 4090-1350	9	13.5	16°	80	10	12,500
CESUS 4090-1900		19		80	10	12,500
CESUS 4090-2700		27		80	10	13,750
CESUS 4100-1500	10	15	—	80	10	12,500
CESUS 4100-2200		22		80	10	12,500
CESUS 4100-3000		30		80	10	13,750
CESUS 4110-1650	11	16.5	16°	100	12	17,800
CESUS 4110-2200		22		100	12	17,800
CESUS 4110-3300		33		100	12	19,580
CESUS 4120-1800	12	18	—	100	12	17,800
CESUS 4120-2600		26		100	12	17,800
CESUS 4120-3600		36		100	12	19,580

4 Flutes

UDC Series

CBN Series

Square

Square

Long Neck Square

Radius

Radius

Long Neck Radius

Taper Neck Radius

Ball

Ball / Long Shank Ball

Long Neck Ball

Taper Neck Ball

Taper

Taper

Spiral

V Cutter

Drill

EURO Series

Technical Data

Milling Conditions for CESUS

Side Milling

WORK MATERIAL			CARBON STEELS S45C / S50C Annealed Materials (~225HB)				ALLOY STEELS SK / SCM Annealed Materials (225~325HB)				STAINLESS STEELS SUS304 Use water soluble or oil coolant.			
Model Number	Outside Diameter (mm)	Length of Cut (mm)	Spindle Speed (min ⁻¹)	Feed Rate (mm/min)	a _p Axial Depth (mm)	a _e Radial Depth (mm)	Spindle Speed (min ⁻¹)	Feed Rate (mm/min)	a _p Axial Depth (mm)	a _e Radial Depth (mm)	Spindle Speed (min ⁻¹)	Feed Rate (mm/min)	a _p Axial Depth (mm)	a _e Radial Depth (mm)
4060-0900	6	9	6,000	1,600	9	1.2	6,000	1,100	9	1.2	6,000	1,100	9	1.2
4060-1300		13	6,000	1,600	13	1.2	6,000	1,100	13	1.2	6,000	1,100	13	1.2
4060-1800		18	6,000	1,170	18	1.2	4,800	800	18	1.2	4,800	800	18	1.2
4070-1050		10.5	5,000	1,450	10.5	1.4	5,000	1,025	10.5	1.4	5,000	1,025	10.5	1.4
4070-1600	7	16	5,000	1,450	16	1.4	5,000	1,025	16	1.4	5,000	1,025	16	1.4
4070-2100		21	5,000	1,060	21	1.4	4,000	750	21	1.4	4,000	750	21	1.4
4080-1200		12	4,300	1,300	12	1.6	4,300	950	12	1.6	4,300	950	12	1.6
4080-1900	8	19	4,300	1,300	19	1.6	4,300	950	19	1.6	4,300	950	19	1.6
4080-2400		24	4,300	950	24	1.6	3,400	695	24	1.6	3,400	695	24	1.6
4090-1350	9	13.5	3,700	1,150	13.5	1.8	3,700	875	13.5	1.8	3,700	875	13.5	1.8
4090-1900		19	3,700	1,150	19	1.8	3,700	875	19	1.8	3,700	875	19	1.8
4090-2700		27	3,700	840	27	1.8	2,960	640	27	1.8	2,960	640	27	1.8
4100-1500		10	15	3,200	1,000	15	2	3,200	800	15	2	3,200	800	15
4100-2200	22		3,200	1,000	22	2	3,200	800	22	2	3,200	800	22	2
4100-3000	30		3,200	730	30	2	2,650	580	30	2	2,650	580	30	2
4110-1650	11	16.5	2,900	900	16.5	2.2	2,900	725	16.5	2.2	2,900	725	16.5	2.2
4110-2200		22	2,900	900	22	2.2	2,900	725	22	2.2	2,900	725	22	2.2
4110-3300	12	33	2,900	650	33	2.2	2,400	530	33	2.2	2,400	530	33	2.2
4120-1800		18	2,650	800	18	2.4	2,650	650	18	2.4	2,650	650	18	2.4
4120-2600		26	2,650	800	26	2.4	2,650	650	26	2.4	2,650	650	26	2.4
4120-3600		36	2,650	580	36	2.4	2,200	475	36	2.4	2,200	475	36	2.4
Milling Amount (mm)			a _p : All Flute a _e : 0.2D				a _p : All Flute a _e : 0.2D				a _p : All Flute a _e : 0.2D			

Slotting

WORK MATERIAL			CARBON STEELS S45C / S50C Annealed Materials (~225HB)			ALLOY STEELS SK / SCM Annealed Materials (225~325HB)			STAINLESS STEELS SUS304 Use water soluble or oil coolant.		
Model Number	Outside Diameter (mm)	Length of Cut (mm)	Spindle Speed (min ⁻¹)	Feed Rate (mm/min)	a _p Axial Depth (mm)	Spindle Speed (min ⁻¹)	Feed Rate (mm/min)	a _p Axial Depth (mm)	Spindle Speed (min ⁻¹)	Feed Rate (mm/min)	a _p Axial Depth (mm)
4060-0900	6	9	6,000	700	6	6,000	700	6	6,000	700	6
4060-1300		13	6,000	700	6	6,000	700	6	6,000	700	6
4060-1800		18	6,000	560	6	4,200	350	6	4,200	350	6
4070-1050		10.5	5,000	625	7	5,000	625	7	5,000	625	7
4070-1600	7	16	5,000	625	7	5,000	625	7	5,000	625	7
4070-2100		21	5,000	500	7	3,500	300	7	3,500	300	7
4080-1200		12	4,300	550	8	4,300	550	8	4,000	500	8
4080-1900	8	19	4,300	550	8	4,300	550	8	4,000	500	8
4080-2400		24	4,300	440	8	3,000	275	8	3,000	275	8
4090-1350	9	13.5	3,500	475	9	3,500	475	9	3,150	430	9
4090-1900		19	3,500	475	9	3,500	475	9	3,150	430	9
4090-2700		27	3,500	380	9	2,450	240	9	2,450	240	9
4100-1500		10	15	2,900	400	10	2,900	400	10	2,900	400
4100-2200	22		2,900	400	10	2,900	400	10	2,900	400	10
4100-3000	30		2,900	320	10	2,000	200	10	2,000	200	10
4110-1650	11	16.5	2,650	340	11	2,650	340	11	2,380	300	11
4110-2200		22	2,650	340	11	2,650	340	11	2,380	300	11
4110-3300		33	2,650	270	11	1,820	170	11	1,820	170	11
4120-1800	12	18	2,420	300	12	2,420	300	12	2,420	300	12
4120-2600		26	2,420	300	12	2,420	300	12	2,420	300	12
4120-3600		36	2,420	240	12	1,650	150	12	1,650	150	12
Milling Amount (mm)			a _p : 1D			a _p : 1D			a _p : 1D		

Note:

- Decrease both spindle speed and feed rate proportionally in case of chattering.
- These milling parameters are calculated based on the shortest overhang length. Longer overhangs may require an adjustment to the milling parameters.
- Reduce the milling amount and feed rate in accordance with required milling precision.
- Every coolant offers stable milling.
- Recommend water soluble or oil coolant for Stainless Steels.

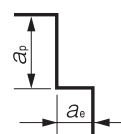

Side Milling
a_p : Axial Depth (mm)
a_e : Radial Depth (mm)

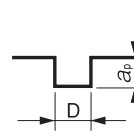

Slotting
a_p : Axial Depth (mm)
D : Outside Diameter (mm)

Milling Example for Slotting CESUS $\phi 10 \times$ Length of Cut 22

SUS304

Tool	CESUS 4100-2200
Spindle Speed	3,200 min ⁻¹
Feed Rate	900 mm/min*
Axial Depth a_p	10 mm
Coolant	Water Soluble
Milling Distance	100 mm

*Milled by higher efficiency conditions than catalogue conditions to evaluate the tool performance.

Milling image

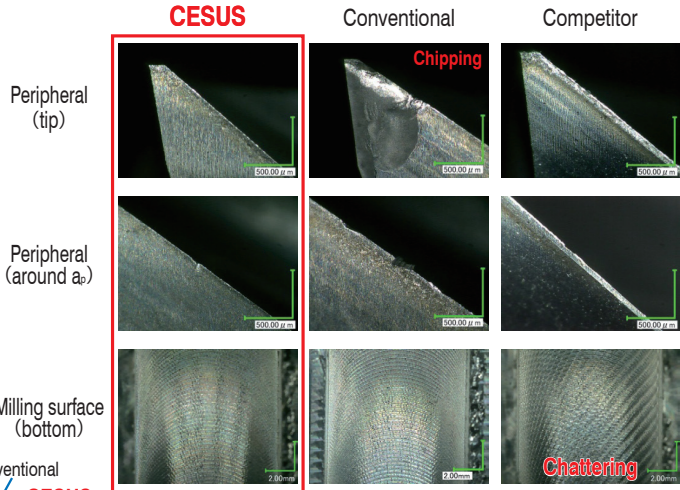
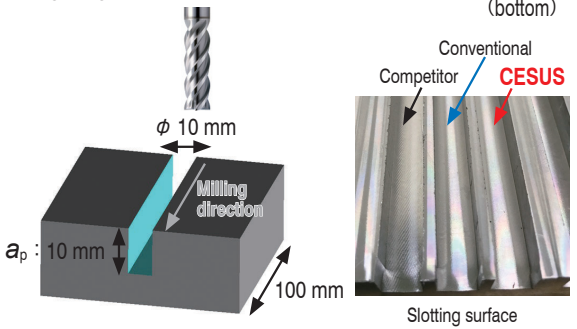

CESUS offers stable milling with less chattering under highly efficient conditions.

Milling Example for Side Milling CESUS $\phi 10 \times$ Length of Cut 22

SUS304

Tool	CESUS 4100-2200
Spindle Speed	2,560 min ⁻¹
Feed Rate	580 mm/min
Axial Depth a_p	10 mm
Radial Depth a_e	2 mm
Coolant	Water Soluble
Milling Distance	64.8 m
Cycle Time	120 min

Milling image

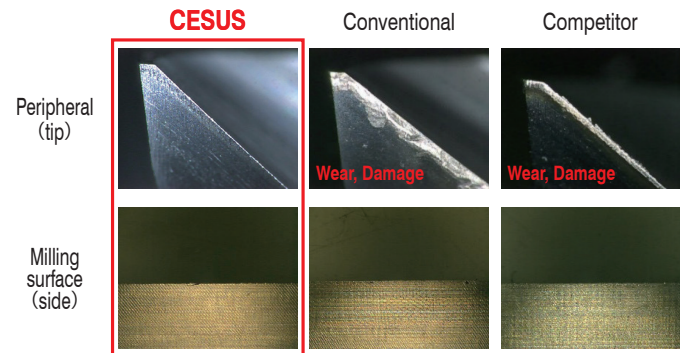
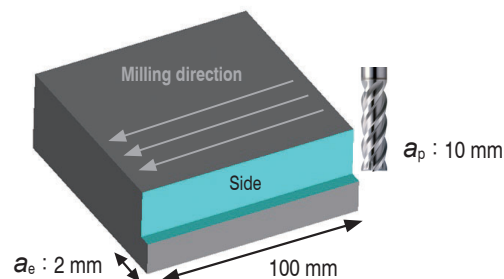

CESUS offers longer tool life with less wear and damage after 120 min of milling! Great surface finish without chattering!

4 Flutes

UDC Series

CBN Series

Square
Long Neck Square

Radius

Radius
Long Neck Radius

Radius
Taper Neck Radius

Ball / Long Shank Ball

Ball
Long Neck Ball

Ball
Taper Neck Ball

Taper
Taper

Spiral V Cutter

Drill

EURO Series

Technical Data



Size $\phi 3 \sim \phi 12$

CRN-ES4000



Material Applications (☆ Highly Recommended ○ Recommended ○ Suggested)

Work Material															
Carbon Steels S45C S55C	Alloy Steels SK / SCM SUS	Prehardened Steels NAK HPM	Hardened Steels			Cast Iron	Aluminum Alloys	Graphite	Copper	Plastics	Glass Filled Plastics	Titanium Alloys	Heat Resistant Alloys	Cemented Carbide	Hard Brittle (Non-Metallic) Materials
			~55HRC	~60HRC	~70HRC										
							○		☆	○					

Features

CrN COAT offers longer tool life.

Special geometry designed for Copper offers excellent milling performance.

Refer to page 174 for 2 flute CRN-ES.

Diameter Tolerance: $0/-0.02(D \leq 6)$, $0/-0.03(D \geq 8)$

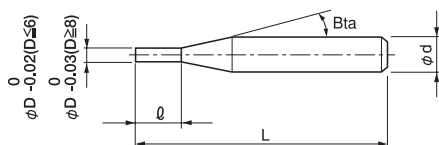

The shank taper angle shown is not an exact value and to avoid contact with the work piece, we recommend the user controls the precise value of this angle. Shank taper angle should not make contact with the work piece.

Total 10 models

Unit (mm)

Model Number	Outside Diameter ϕD	Length of Cut ℓ	Shank Taper Angle Bta	Overall Length L	Shank Diameter ϕd	Price ¥
CRN-ES 4030-0900	3	9	11°	50	6	4,620
CRN-ES 4030-1200		12	11°	55	6	6,820
CRN-ES 4040-1200	4	12	11°	50	6	4,950
CRN-ES 4040-1600		16	11°	55	6	7,150
CRN-ES 4050-1500	5	15	11°	55	6	5,060
CRN-ES 4060-1800	6	18	—	60	6	5,390
CRN-ES 4060-2400		24	—	65	6	8,250
CRN-ES 4080-2400	8	24	—	80	8	9,480
CRN-ES 4100-3000	10	30	—	100	10	12,720
CRN-ES 4120-3600	12	36	—	100	12	15,840

Milling Conditions for CRN-ES (4 Flutes)

Side Milling

◆3D flute length type

WORK MATERIAL		COPPER C1100			
Model Number	Outside Diameter (mm)	Spindle Speed (min ⁻¹)	Feed Rate (mm/min)	a_p Axial Depth (mm)	a_e Radial Depth (mm)
4030-0900	3	10,000	600	4.5	0.3
4040-1200	4	8,000	650	6	0.4
4050-1500	5	6,500	750	7.5	0.5
4060-1800	6	5,500	750	9	0.6
4080-2400	8	4,200	700	12	0.8
4100-3000	10	3,500	700	15	1
4120-3600	12	2,800	700	18	1.2

◆4D flute length type

WORK MATERIAL		COPPER C1100			
Model Number	Outside Diameter (mm)	Spindle Speed (min ⁻¹)	Feed Rate (mm/min)	a_p Axial Depth (mm)	a_e Radial Depth (mm)
4030-1200	3	5,000	300	7.5	0.15
4040-1600	4	4,000	325	10	0.2
4060-2400	6	3,500	400	15	0.3

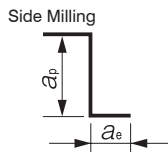

a_p : Axial Depth (mm)
 a_e : Radial Depth (mm)
 D : Outside Diameter (mm)

Milling	Length of Cut	
	3D Flute Length Type	4D Flute Length Type
Side Milling	a_p 1.5D a_e 0.1D	a_p 2.5D a_e 0.05D

Note:

- Decrease both spindle speed and feed rate proportionally in case of chattering.
- Adjust the milling amount and feed rate in accordance with required precision.
- Recommend water soluble or oil coolant.
- Recommended for Pure Copper. Not suitable for Tungsten Copper.

4 Flutes

UDC Series

CBN Series

Square

Square

Long Neck Square

Radius

Radius

Long Neck Radius

Taper Neck Radius

Ball / Long Shank Ball

Ball

Long Neck Ball

Taper Neck Ball

Taper

Taper

Spiral V Cutter

Drill

EURO Series

Technical Data



Size $\phi 3 \sim \phi 10$

DCES4000



Material Applications (☆ Highly Recommended ○ Recommended ○ Suggested)

Work Material															
Carbon Steels S45C S55C	Alloy Steels SK / SCM SUS	Prehardened Steels NAK HPM	Hardened Steels			Cast Iron	Aluminum Alloys	Graphite	Copper	Plastics	Glass Filled Plastics	Titanium Alloys	Heat Resistant Alloys	Cemented Carbide	Hard Brittle (Non-Metallic) Materials
			~55HRC	~60HRC	~70HRC										
							○	☆	○	○	◎				○

Features

Diamond coated 4 flute square end mills for Graphite Electrodes.

New diamond coating with a highly adhesive base layer offers excellent wear resistance and longer tool life.

Refer to page 176 for 2 flute DCES.

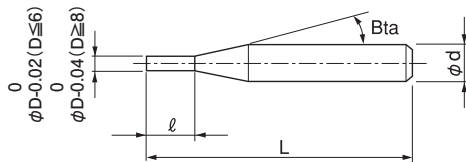

The shank taper angle shown is not an exact value and to avoid contact with the work piece, we recommend the user controls the precise value of this angle. Shank taper angle should not make contact with the work piece.

Total 11 models

Unit (mm)

Model Number	Outside Diameter ϕD	Length of Cut ℓ	Shank Taper Angle Bta	Overall Length L	Shank Diameter ϕd	Price \yen
DCES 4030-0900	3	9	16°	50	6	20,000
DCES 4030-1200		12		50	6	26,000
DCES 4040-1200	4	12	16°	50	6	21,000
DCES 4040-1600		16		60	6	27,000
DCES 4060-1800	6	18	—	60	6	22,000
DCES 4060-1800L		18		100	6	30,000
DCES 4060-2400		24		60	6	28,000
DCES 4080-2400	8	24	—	80	8	35,000
DCES 4080-3200		32		80	8	41,000
DCES 4100-3000	10	30	—	90	10	48,000
DCES 4100-4000		40		90	10	54,000

Milling Conditions for DCES (4 Flutes)

WORK MATERIAL			GRAPHITE				
Model Number	Outside Diameter (mm)	Length of Cut (mm)	Spindle Speed (min ⁻¹)	Feed Rate (mm/min)	Side Milling		Slotting
					a_p Axial Depth (mm)	a_e Radial Depth (mm)	a_p Axial Depth (mm)
4030-0900	3	9	25,000	3,000	6	0.15	0.75
4030-1200	3	12	25,000	3,000	6	0.15	0.75
4040-1200	4	12	19,000	2,350	9	0.2	1
4040-1600	4	16	19,000	2,350	9	0.2	1
4060-1800	6	18	13,000	1,800	12	0.48	1.5
4060-1800L	6	18	13,000	1,800	12	0.48	1.5
4060-2400	6	24	13,000	1,800	12	0.48	1.5
4080-2400	8	24	9,500	1,400	16	0.64	2
4080-3200	8	32	9,500	1,400	16	0.64	2
4100-3000	10	30	7,500	1,200	20	0.8	2.5
4100-4000	10	40	7,500	1,200	20	0.8	2.5

Slotting

a_p : Axial Depth (mm)
D : Outside Diameter (mm)

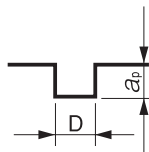

Side Milling

a_p : Axial Depth (mm)
 a_e : Radial Depth (mm)

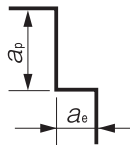

Note:

- Use a milling machine dedicated for Graphite.
- Recommend air blow for Graphite.

4 Flutes

UDC Series

CBN Series

Square

Long Neck Square

Radius

Radius

Long Neck Radius

Taper Neck Radius

Ball / Long Shank Ball

Ball

Long Neck Ball

Taper Neck Ball

Taper

Taper

Spiral V Cutter

Spiral V Cutter

Drill

Drill

EURO Series

EURO Series

Technical Data

Technical Data

4 Flutes NON-COAT for Graphite Milling



Size $\phi 2 \sim \phi 20$

CGE



Material Applications (☆ Highly Recommended ○ Recommended ○ Suggested)

Work Material															
Carbon Steels S45C S55C	Alloy Steels SK / SCM SUS	Prehardened Steels NAK HPM	Hardened Steels			Cast Iron	Aluminum Alloys	Graphite	Copper	Plastics	Glass Filled Plastics	Titanium Alloys	Heat Resistant Alloys	Cemented Carbide	Hard Brittle (Non-Metallic) Materials
			~55HRC	~60HRC	~70HRC										
							○	☆	○	○	○				

Features

Designed for Graphite.
Specific carbide grade offers wear and abrasion resistance.
High helix angle reduces chipping of the work material.

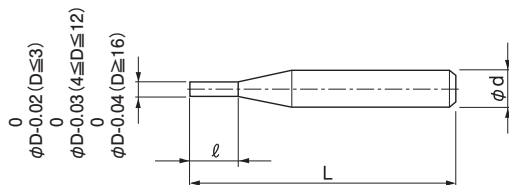

Total 10 models

Unit (mm)

Model Number	Outside Diameter ϕD	Length of Cut l	Overall Length L	Shank Diameter ϕd	Price ¥
CGE 4020	2	15	60	3	16,800
CGE 4030	3	30	80	3	16,800
CGE 4040	4	30	90	4	17,700
CGE 4050	5	35	100	6	18,900
CGE 4060	6	40	150	6	19,320
CGE 4080	8	40	150	8	24,200
CGE 4100	10	45	180	10	30,580
CGE 4120	12	55	200	12	36,850
CGE 4160	16	70	200	16	56,430
CGE 4200	20	70	200	20	87,230

Milling Conditions for CGE

WORK MATERIAL		GRAPHITE			
		Side Milling			
Model Number	Outside Diameter (mm)	Spindle Speed (min ⁻¹)	Feed Rate (mm/min)	a_p Axial Depth (mm)	a_e Radial Depth (mm)
4020	2	15,900	300	1	0.1
4030	3	15,900	500	1.5	0.15
4040	4	15,900	650	2	0.2
4050	5	12,700	750	2.5	0.25
4060	6	10,600	850	3	0.3
4080	8	8,000	950	4	0.4
4100	10	6,400	1,000	5	0.5
4120	12	5,310	1,000	6	0.6
4160	16	3,980	1,000	8	0.8
4200	20	3,180	1,000	10	1

Milling Amount for side milling (mm)

$$a_p = 0.5D$$

$$a_e = 0.05D$$

a_p : Axial Depth (mm)

a_e : Radial Depth (mm)

D : Outside Diameter (mm)

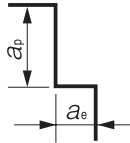

Note:

- Use a milling machine dedicated for Graphite.
- Recommend air blow for Graphite.

4 Flutes

UDC Series

CBN Series

Square

Long Neck Square

Radius

Radius

Long Neck Radius

Taper Neck Radius

Ball / Long Shank Ball

Ball

Long Neck Ball

Taper Neck Ball

Taper

Taper

Spiral V Cutter

Drill

EURO Series

Technical Data



Size $\phi 1 \sim \phi 12$

HMS



Material Applications (☆ Highly Recommended ○ Recommended ○ Suggested)

Work Material															
Carbon Steels	Alloy Steels	Prehardened Steels	Hardened Steels			Cast Iron	Aluminum Alloys	Graphite	Copper	Plastics	Glass Filled Plastics	Titanium Alloys	Heat Resistant Alloys	Cemented Carbide	Hard Brittle (Non-Metallic) Materials
S45C S55C	SK / SCM SUS	NAK HPM	~55HRC	~60HRC	~70HRC										
		○	○	○	○										
					○ ~65HRC										

Features

Offering outstanding tool life by selecting appropriate 3, 4 or 6 flutes on each tool diameter.
Highly efficient milling on hard materials up to 65HRC with HARDMAX COAT.

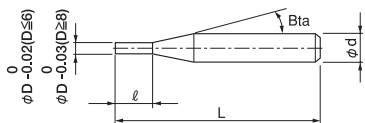

The shank taper angle shown is not an exact value and to avoid contact with the work piece, we recommend the user controls the precise value of this angle. Shank taper angle should not make contact with the work piece.

Total 27 models

Unit (mm)

Model Number	Outside Diameter ϕD	Length of Cut ℓ	Shank Taper Angle B_{ta}	Overall Length L	Shank Diameter ϕd	Number of Flutes	Price ¥
HMS 3010-0250	1	2.5	16°	45	4	3	7,500
HMS 3010-0350		3.5		45			10,800
HMS 3015-0400	1.5	4	16°	45	4	3	7,500
HMS 3015-0600		6		45			10,800
HMS 3020-0400	2	4	16°	45	4	3	6,700
HMS 3020-0700		7		45			10,000
HMS 3030-0600	3	6	16°	50	6	3	9,240
HMS 3030-1000		10		60			9,800
HMS 3030-1500		15		60			10,920
HMS 4040-0800	4	8	16°	50	6	4	9,870
HMS 4040-1200		12		60			10,470
HMS 4040-2000		20		70			11,450
HMS 4050-1000	5	10	16°	50	6	4	10,500
HMS 4050-1500		15		60			11,100
HMS 4050-2500		25		70			12,180
HMS 6060-1300	6	13	—	50	6	6	11,340
HMS 6060-1800		18		60			12,100
HMS 6060-2600		26		70			13,230
HMS 6080-1900	8	19	—	60	8	6	14,630
HMS 6080-2400		24		70			15,000
HMS 6080-3600		36		90			17,160
HMS 6100-2200	10	22	—	70	10	6	18,360
HMS 6100-3000		30		80			20,000
HMS 6100-4600		46		100			22,990
HMS 6120-2600	12	26	—	75	12	6	24,750
HMS 6120-3600		36		100			25,400
HMS 6120-5600		56		120			28,600

Milling Conditions for HMS

◆ Short length of cut

WORK MATERIAL			PREHARDENED STEELS HARDENED STEELS (40~50HRC)					HARDENED STEELS (50~60HRC)					HARDENED STEELS (60~65HRC)									
Model Number	Number of Flutes	Outside Diameter (mm)	Spindle Speed (min ⁻¹)	Feed Rate (mm/min)	Slotting		Side Milling		Spindle Speed (min ⁻¹)	Feed Rate (mm/min)	Slotting		Side Milling		Spindle Speed (min ⁻¹)	Feed Rate (mm/min)	Slotting		Side Milling			
					a_p (mm)	a_e (mm)	a_p (mm)	a_e (mm)			a_p (mm)	a_e (mm)	a_p (mm)	a_e (mm)			a_p (mm)	a_e (mm)	a_p (mm)	a_e (mm)		
3010-0250	3	1	9,500	140	0.05	1	0.05	6,400	95	0.05	1	0.05	6,400	90	0.05	1	0.05	6,400	90	0.05	1	0.05
3015-0400		1.5	6,400	100	0.075	1.5	0.075	4,200	60	0.075	1.5	0.075	4,200	60	0.075	1.5	0.075	4,200	60	0.075	1.5	0.075
3020-0400		2	4,700	80	0.1	2	0.1	3,200	75	0.1	2	0.1	3,200	70	0.1	2	0.1	3,200	70	0.1	2	0.1
3030-0600		3	3,200	85	0.15	3	0.15	2,100	80	0.15	3	0.15	2,100	80	0.15	3	0.15	2,100	80	0.15	3	0.15
4040-0800	4	4	2,400	90	0.2	4	0.2	1,600	85	0.2	4	0.2	1,600	80	0.2	4	0.2	1,600	80	0.2	4	0.2
4050-1000		5	1,900	90	0.25	5	0.25	1,300	85	0.25	5	0.25	1,300	80	0.25	5	0.25	1,300	80	0.25	5	0.25
6060-1300	6	6	1,600	170	0.3	6	0.3	1,100	120	0.3	6	0.3	1,100	110	0.3	6	0.3	1,100	110	0.3	6	0.3
6080-1900		8	1,200	170	0.4	8	0.4	800	120	0.4	8	0.4	800	110	0.4	8	0.4	800	110	0.4	8	0.4
6100-2200		10	950	170	0.5	15	0.5	640	100	0.5	15	0.5	640	80	0.5	15	0.5	640	80	0.5	15	0.5
6120-2600		12	800	170	0.5	18	0.5	530	90	0.5	18	0.5	530	70	0.5	18	0.5	530	70	0.5	18	0.5
Milling Amount (mm)	Slotting	$a_p \leq 0.05D$ (max 0.5 mm)																				
	Side Milling	$D \leq \phi 8$ $a_p = 1D$ $D \geq \phi 10$ $a_p = 1.5D$ $a_e \leq 0.05D$ (max 0.5 mm)																				

◆ High speed milling for short length of cut

WORK MATERIAL			PREHARDENED STEELS HARDENED STEELS (40~50HRC)					HARDENED STEELS (50~60HRC)					HARDENED STEELS (60~65HRC)				
Model Number	Number of Flutes	Outside Diameter (mm)	Spindle Speed (min ⁻¹)	Feed Rate (mm/min)	Side Milling		Spindle Speed (min ⁻¹)	Feed Rate (mm/min)	Side Milling		Spindle Speed (min ⁻¹)	Feed Rate (mm/min)	Side Milling				
					a_p (mm)	a_e (mm)			a_p (mm)	a_e (mm)			a_p (mm)	a_e (mm)			
3010-0250	3	1	22,500	630	1.5	0.03	20,000	540	1.5	0.02	15,000	450	0.5	0.01			
3015-0400		1.5	18,000	720	2.25	0.045	16,000	630	2.25	0.03	11,500	540	0.75	0.015			
3020-0400		2	14,300	850	3	0.06	13,000	750	3	0.04	8,500	630	1	0.02			
3030-0600		3	13,100	1,120	4.5	0.09	11,200	950	4.5	0.06	6,700	760	1.5	0.03			
4040-0800	4	4	11,300	1,300	6	0.12	9,900	1,170	6	0.08	2,850	630	8	0.08			
4050-1000		5	10,100	1,530	7.5	0.15	8,900	1,350	7.5	0.1	2,400	700	10	0.1			
6060-1300	6	6	8,900	1,950	9	0.18	8,000	1,800	9	0.12	2,150	830	12	0.12			
6080-1900		8	7,700	2,350	12	0.24	6,900	2,200	12	0.16	2,100	900	16	0.16			
6100-2200		10	6,700	3,100	15	0.3	6,000	2,700	15	0.2	2,000	1,000	20	0.2			
6120-2600		12	5,800	3,000	18	0.36	5,300	2,500	18	0.24	1,950	1,070	24	0.24			
Milling Amount (mm)	Side Milling	$a_p = 1.5D$ $a_e = 0.03D$ (max 0.5 mm)					$a_p = 1.5D$ $a_e = 0.02D$					$D \leq \phi 3$ $a_p = 0.5D$ $a_e = 0.01D$ $D \geq \phi 4$ $a_p = 2D$ $a_e = 0.02D$					

a_p : Axial Depth (mm)
 a_e : Radial Depth (mm)
 D : Outside Diameter (mm)

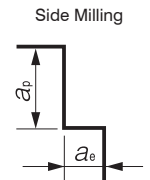
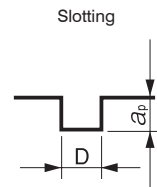

3 Flutes

4 Flutes

6 Flutes

UDC Series

CBN Series

Square

Long Neck Square

Radius

Long Neck Radius

Taper Neck Radius

Ball / Long Shank Ball

Long Neck Ball

Taper Neck Ball

Taper

Spiral V Cutter

Drill

EURO Series

Technical Data

Milling Conditions for HMS

◆Medium length of cut

WORK MATERIAL			PREHARDENED STEELS HARDENED STEELS (40~50HRC)					HARDENED STEELS (50~60HRC)					HARDENED STEELS (60~65HRC)							
Model Number	Number of Flutes	Outside Diameter (mm)	Spindle Speed (min ⁻¹)	Feed Rate (mm/min)	Slotting		Side Milling		Spindle Speed (min ⁻¹)	Feed Rate (mm/min)	Slotting		Side Milling		Spindle Speed (min ⁻¹)	Feed Rate (mm/min)	Slotting		Side Milling	
					a _p (mm)	a _e (mm)	a _p (mm)	a _e (mm)			a _p (mm)	a _e (mm)	a _p (mm)	a _e (mm)						
3030-1000	3	3	3,200	43~85	0.09	6	0.09	2,100	40~80	0.09	6	0.09	2,100	40~80	0.09	6	0.09	6	0.09	
4040-1200	4	4	2,400	45~90	0.12	8	0.12	1,600	43~85	0.12	8	0.12	1,600	40~80	0.12	8	0.12	8	0.12	
4050-1500		5	1,900	45~90	0.15	10	0.15	1,300	43~85	0.15	10	0.15	1,300	40~80	0.15	10	0.15	10	0.15	
6060-1800	6	6	1,600	85~170	0.18	12	0.18	1,100	60~120	0.18	12	0.18	1,100	55~110	0.18	12	0.18	12	0.18	
6080-2400		8	1,200	85~170	0.24	16	0.24	800	60~120	0.24	16	0.24	800	55~110	0.24	16	0.24	16	0.24	
6100-3000		10	950	85~170	0.3	25	0.3	640	50~100	0.3	25	0.3	640	40~80	0.3	25	0.3	25	0.3	
6120-3600		12	800	85~170	0.3	30	0.3	530	45~90	0.3	30	0.3	530	35~70	0.3	30	0.3	30	0.3	
Milling Amount (mm)		Slotting		a _p ≤ 0.03D (max 0.3 mm)																
		Side Milling		D ≤ φ8 a _p = 2D D ≥ φ10 a _p = 2.5D a _e ≤ 0.03D (max 0.3 mm)																

◆Long length of cut

WORK MATERIAL			PREHARDENED STEELS HARDENED STEELS (40~50HRC)					HARDENED STEELS (50~60HRC)					HARDENED STEELS (60~65HRC)						
Model Number	Number of Flutes	Outside Diameter (mm)	Spindle Speed (min ⁻¹)	Feed Rate (mm/min)	Side Milling		Spindle Speed (min ⁻¹)	Feed Rate (mm/min)	Side Milling		Spindle Speed (min ⁻¹)	Feed Rate (mm/min)	Side Milling						
					a _p (mm)	a _e (mm)			a _p (mm)	a _e (mm)			a _p (mm)	a _e (mm)					
3010-0350	3	1	9,500	140~210	3	0.02	6,400	95~143	3	0.02	6,400	95~133	3	0.02					
3015-0600		1.5	6,300	100~150	4.5	0.03	4,200	80~120	4.5	0.03	4,200	80~112	4.5	0.03					
3020-0700		2	4,700	80~120	6	0.04	3,200	75~113	6	0.04	3,200	75~113	6	0.04					
3030-1500		3	3,200	85~128	9	0.06	2,100	80~120	9	0.06	2,100	80~120	9	0.06					
4040-2000	4	4	2,400	90~135	12	0.08	1,600	85~128	12	0.08	1,600	83~125	12	0.08					
4050-2500		5	1,900	90~135	15	0.1	1,300	85~128	15	0.1	1,300	83~125	15	0.1					
6060-2600	6	6	1,600	170~255	18	0.12	1,100	120~180	18	0.12	1,100	112~168	18	0.12					
6080-3600		8	1,200	170~255	24	0.16	800	120~180	24	0.16	800	110~166	24	0.16					
6100-4600		10	950	170~255	30	0.2	640	100~150	30	0.2	640	88~132	30	0.2					
6120-5600		12	800	170~255	36	0.24	530	90~135	36	0.24	530	76~114	36	0.24					
Milling Amount (mm)		Side Milling		a _p = 3D a _e ≤ 0.02D															

a_p : Axial Depth (mm)
a_e : Radial Depth (mm)
D : Outside Diameter (mm)

Note:

- Recommend down cut processing.
- Reduce cutting amount, feed rate, and apply zero-cut in accordance with required surface quality.
- Recommend air blow or oil mist.

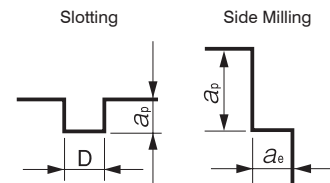



3 Flutes

4 Flutes

6 Flutes

UDC Series

CBN Series

Square
Long Neck Square

Radius
Radius
Long Neck Radius
Taper Neck Radius

Ball
Ball / Long Shank Ball
Long Neck Ball
Taper Neck Ball

Taper
Taper

Spiral V Cutter

Drill

EURO Series

Technical Data



Size $\phi 0.1 \sim \phi 6$

HLS2000



Additional 5 models

Material Applications (☆ Highly Recommended ○ Recommended ○ Suggested)

Work Material															
Carbon Steels S45C S55C	Alloy Steels SK / SCM SUS	Prehardened Steels NAK HPM	Hardened Steels			Cast Iron	Aluminum Alloys	Graphite	Copper	Plastics	Glass Filled Plastics	Titanium Alloys	Heat Resistant Alloys	Cemented Carbide	Hard Brittle (Non-Metallic) Materials
			~55HRC	~60HRC	~70HRC										
○	○	○	○	○	○	○			○			○	○		

Features

HARDMAX coating and optimized tool design control tool chipping. Longer tool life with deep rib milling on hard materials.

High Accuracy: Diameter Tolerance: 0/-0.01 ($D \leq 0.15$), 0/-0.015 ($D \geq 0.2$)

Refer to page 276 for 4 flute HLS.

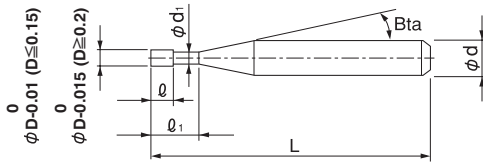

The shank taper angle shown is not an exact value and to avoid contact with the work piece, we recommend the user controls the precise value of this angle. Shank taper angle should not make contact with the work piece.

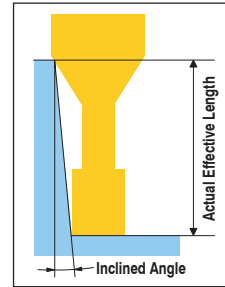

Total 189 models

Unit (mm)

Model Number	Outside Diameter ϕD	Effective Length l_1	Length of Cut l	Neck Diameter ϕd_1	Shank Taper Angle Bta	Overall Length L	Shank Diameter ϕd	Price ¥	Effective Length by Inclined Angles				
									30'	1°	1° 30'	2°	3°
HLS 2001-003	0.1	0.3	0.1	0.088	11°	45	4	11,160	0.33	0.36	0.38	0.40	0.45
HLS 2001-005		0.5				45	4	12,240	0.54	0.58	0.61	0.64	0.69
※ HLS 2001-0075		0.75				45	4	13,560	0.80	0.85	0.90	0.95	1.07
※ HLS 2001-010		1				45	4	15,240	1.07	1.12	1.18	1.25	1.41
HLS 20015-005	0.15	0.5	0.15	0.128	11°	45	4	11,400	0.58	0.61	0.63	0.66	0.71
HLS 20015-0075		0.75				45	4	12,600	0.84	0.88	0.91	0.94	1.02
HLS 20015-010		1				45	4	12,600	1.10	1.14	1.18	1.23	1.32
HLS 2002-005		0.5				45	4	7,320	0.65	0.70	0.74	0.78	0.85
HLS 2002-010	0.2	1	0.3	0.18	16°	45	4	7,920	1.18	1.25	1.31	1.36	1.45
※ HLS 2002-015		1.5				45	4	9,600	1.67	1.76	1.84	1.90	2.01
※ HLS 2002-020		2				45	4	10,800	2.23	2.33	2.41	2.49	2.68
※ HLS 2002-030		3				45	4	11,160	3.27	3.39	3.51	3.63	3.91

※Additional model

Next Page ➡

Model Number	Outside Diameter ϕD	Effective Length ℓ_1	Length of Cut ℓ	Neck Diameter ϕd_1	Shank Taper Angle Bta	Overall Length L	Shank Diameter ϕd	Price ¥	Effective Length by Inclined Angles				
									30°	1°	1° 30'	2°	3°
HLS 2003-010	0.3	1	0.4	0.28	16°	45	4	6,480	1.22	1.30	1.37	1.43	1.55
HLS 2003-015		1.5				45	4	6,480	1.71	1.82	1.91	1.98	2.12
HLS 2003-020		2				45	4	7,920	2.24	2.36	2.46	2.55	2.70
HLS 2003-025		2.5				45	4	8,280	2.77	2.91	3.02	3.11	3.27
HLS 2003-030		3				45	4	8,280	3.30	3.45	3.56	3.66	3.83
HLS 2003-040		4				45	4	9,480	4.35	4.51	4.64	4.75	4.94
HLS 2003-060		6				45	4	10,560	6.43	6.63	6.78	6.91	7.12
HLS 2003-090		9				45	4	11,160	9.53	9.76	9.94	10.09	10.32
HLS 2004-015		0.4				1.5	0.6	0.38	16°	45	4	4,680	1.77
HLS 2004-020	2		45	4	4,680	2.31				2.47	2.60	2.71	2.91
HLS 2004-025	2.5		45	4	4,680	2.85				3.02	3.16	3.28	3.49
HLS 2004-030	3		45	4	4,680	3.38				3.57	3.72	3.85	4.07
HLS 2004-035	3.5		45	4	4,680	3.91				4.11	4.27	4.41	4.64
HLS 2004-040	4		45	4	4,680	4.44				4.65	4.82	4.96	5.21
HLS 2004-050	5		45	4	4,680	5.49				5.73	5.91	6.06	6.33
HLS 2004-080	8		45	4	10,200	8.63				8.91	9.13	9.31	9.62
HLS 2004-120	12		45	4	11,160	12.77				13.10	13.36	13.57	13.91
HLS 2005-015	0.5	1.5	0.7	0.48	16°	45	4	3,360	1.83	1.99	2.13	2.25	2.48
HLS 2005-020		2				45	4	3,360	2.37	2.56	2.71	2.85	3.09
HLS 2005-025		2.5				45	4	3,360	2.92	3.12	3.29	3.43	3.69
HLS 2005-030		3				45	4	3,360	3.45	3.68	3.85	4.01	4.28
HLS 2005-040		4				45	4	3,360	4.52	4.77	4.97	5.14	5.44
HLS 2005-050		5				45	4	3,360	5.58	5.86	6.08	6.26	6.58
HLS 2005-060		6				45	4	3,360	6.64	6.94	7.17	7.37	7.71
HLS 2005-080		8				45	4	5,640	8.74	9.07	9.33	9.56	9.93
HLS 2005-100		10				50	4	5,640	10.82	11.19	11.48	11.72	12.12
HLS 2005-150	15	50	4	7,200	16.00	16.44	16.78	17.05	17.50				
HLS 2006-020	0.6	2	0.9	0.58	16°	45	4	3,600	2.39	2.62	2.80	2.96	3.24
HLS 2006-030		3				45	4	3,600	3.49	3.75	3.96	4.14	4.32
HLS 2006-040		4				45	4	3,600	4.57	4.86	5.09	5.29	5.69
HLS 2006-050		5				45	4	3,600	5.64	5.96	6.21	6.43	6.92
HLS 2006-060		6				45	4	3,600	6.70	7.05	7.32	7.57	8.14
HLS 2006-070		7				45	4	4,560	7.76	8.13	8.42	8.71	9.36
HLS 2006-080		8				45	4	5,880	8.81	9.20	9.52	9.85	10.59
HLS 2006-100		10				45	4	6,720	10.91	11.34	11.72	12.13	13.04
HLS 2006-120		12				50	4	7,560	13.00	13.47	13.92	14.40	15.48
HLS 2006-180		18				50	4	9,120	19.23	19.85	20.52	21.24	22.82

Next Page ➡

Model Number	Outside Diameter ϕD	Effective Length ℓ_1	Length of Cut ℓ	Neck Diameter ϕd_1	Shank Taper Angle Bta	Overall Length L	Shank Diameter ϕd	Price ¥	Effective Length by Inclined Angles				
									30'	1°	1° 30'	2°	3°
HLS 2007-020	0.7	2	1	0.68	16°	45	4	4,080	2.39	2.62	2.80	2.96	3.24
HLS 2007-040		4				45	4	4,080	4.57	4.86	5.09	5.29	5.69
HLS 2007-060		6				45	4	4,080	6.70	7.05	7.32	7.57	8.14
HLS 2007-080		8				45	4	6,600	8.81	9.20	9.52	9.85	10.59
HLS 2007-100		10				50	4	7,520	10.91	11.34	11.72	12.13	13.04
HLS 2008-030	0.8	3	1.2	0.78	16°	45	4	3,960	3.49	3.75	3.96	4.14	4.32
HLS 2008-040		4				45	4	3,960	4.57	4.86	5.09	5.29	5.69
HLS 2008-050		5				45	4	3,960	5.64	5.96	6.21	6.43	6.92
HLS 2008-060		6				45	4	3,960	6.70	7.05	7.32	7.57	8.14
HLS 2008-080		8				45	4	3,960	8.81	9.20	9.52	9.85	10.59
HLS 2008-100		10				50	4	5,880	10.91	11.34	11.72	12.13	13.04
HLS 2008-120		12				50	4	6,600	13.00	13.47	13.92	14.40	15.48
HLS 2008-160		16				50	4	7,560	17.16	17.73	18.32	18.96	20.38
HLS 2008-240		24				60	4	9,240	25.42	26.24	27.13	28.07	30.17
HLS 2009-040		0.9				4	1.3	0.88	16°	45	4	4,560	4.57
HLS 2009-060	6		45	4	4,560	6.70				7.05	7.32	7.57	8.14
HLS 2009-080	8		45	4	4,560	8.81				9.20	9.52	9.85	10.59
HLS 2009-100	10		45	4	4,560	10.91				11.34	11.72	12.13	13.04
HLS 2009-150	15		50	4	6,790	16.12				16.66	17.22	17.82	19.15
HLS 2010-030	1	3	1.5	0.95	16°	45	4	3,600	3.62	3.85	4.04	4.21	4.54
HLS 2010-040		4				45	4	3,600	4.69	4.95	5.16	5.36	5.76
HLS 2010-050		5				45	4	3,600	5.75	6.04	6.27	6.49	6.98
HLS 2010-060		6				45	4	3,600	6.80	7.12	7.38	7.63	8.21
HLS 2010-070		7				45	4	3,600	7.85	8.19	8.48	8.77	9.43
HLS 2010-080		8				45	4	3,600	8.90	9.26	9.58	9.91	10.65
HLS 2010-090		9				45	4	3,600	9.95	10.33	10.68	11.05	11.88
HLS 2010-100		10				45	4	3,600	10.99	11.39	11.78	12.19	13.10
HLS 2010-120		12				45	4	3,600	13.07	13.52	13.98	14.47	15.55
HLS 2010-140		14				45	4	3,600	15.15	15.65	16.18	16.74	18.00
HLS 2010-160		16				50	4	5,880	17.22	17.78	18.38	19.02	20.44
※ HLS 2010-180		18				55	4	5,880	19.29	19.92	20.59	21.30	22.90
HLS 2010-200		20				55	4	5,880	21.35	22.04	22.78	23.57	25.34
HLS 2010-250		25				70	4	6,720	26.51	27.37	28.29	29.27	No Interference
HLS 2010-300		30				70	4	7,560	31.66	32.69	33.79	34.96	No Interference

※Additional model

Next Page ➡

Model Number	Outside Diameter ϕD	Effective Length ℓ_1	Length of Cut ℓ	Neck Diameter ϕd_1	Shank Taper Angle Bta	Overall Length L	Shank Diameter ϕd	Price ¥	Effective Length by Inclined Angles				
									30°	1°	1° 30'	2°	3°
HLS 2012-040	1.2	4	1.8	1.14	16°	45	4	3,840	4.13	4.27	4.41	4.57	4.91
HLS 2012-060		6				45	4	3,840	6.19	6.40	6.61	6.84	7.36
HLS 2012-080		8				45	4	3,840	8.26	8.52	8.81	9.12	9.80
HLS 2012-100		10				45	4	3,840	10.32	10.65	11.01	11.40	12.25
HLS 2012-120		12				45	4	3,840	12.38	12.78	13.21	13.67	14.70
HLS 2012-160		16				50	4	6,000	16.51	17.04	17.62	18.23	19.59
HLS 2012-200		20				60	4	6,000	20.63	21.30	22.02	22.78	24.49
HLS 2014-060	1.4	6	2.1	1.34	16°	45	4	3,960	6.19	6.40	6.61	6.84	7.36
HLS 2014-080		8				45	4	3,960	8.26	8.52	8.81	9.12	9.80
HLS 2014-100		10				45	4	3,960	10.32	10.65	11.01	11.40	12.25
HLS 2014-120		12				45	4	3,960	12.38	12.78	13.21	13.67	14.70
HLS 2014-140		14				45	4	3,960	14.44	14.91	15.42	15.95	17.15
HLS 2014-160		16				50	4	4,560	16.51	17.04	17.62	18.23	19.59
HLS 2014-220		22				55	4	6,120	22.69	23.43	24.22	25.06	No Interference
HLS 2015-040	1.5	4	2.3	1.44	16°	45	4	3,840	4.13	4.27	4.41	4.57	4.91
HLS 2015-060		6				45	4	3,840	6.19	6.40	6.61	6.84	7.36
HLS 2015-080		8				45	4	3,840	8.26	8.52	8.81	9.12	9.80
HLS 2015-100		10				45	4	3,840	10.32	10.65	11.01	11.40	12.25
HLS 2015-120		12				45	4	3,840	12.38	12.78	13.21	13.67	14.70
HLS 2015-140		14				50	4	3,960	14.44	14.91	15.42	15.95	17.15
HLS 2015-160		16				50	4	3,960	16.51	17.04	17.62	18.23	19.59
HLS 2015-180		18				55	4	3,960	18.57	19.17	19.82	20.51	22.04
HLS 2015-200		20				55	4	3,960	20.63	21.30	22.02	22.78	No Interference
HLS 2015-250		25				70	4	5,880	25.79	26.63	27.52	28.48	No Interference
HLS 2015-300		30				70	4	5,880	30.95	31.95	33.02	34.17	No Interference
HLS 2015-350		35				70	4	6,600	36.10	37.27	38.53	No Interference	No Interference
HLS 2015-400		40				80	4	7,440	41.26	42.60	44.03	No Interference	No Interference
HLS 2015-450		45				80	4	7,440	46.42	47.92	No Interference	No Interference	No Interference
HLS 2016-060	1.6	6	2.4	1.51	16°	45	4	3,960	6.23	6.43	6.65	6.88	7.40
HLS 2016-080		8				45	4	3,960	8.29	8.56	8.85	9.16	9.85
HLS 2016-100		10				45	4	3,960	10.35	10.69	11.05	11.43	12.29
HLS 2016-120		12				45	4	3,960	12.42	12.82	13.25	13.71	14.74
HLS 2016-140		14				50	4	3,960	14.48	14.95	15.45	15.99	17.19
HLS 2016-160		16				50	4	3,960	16.54	17.08	17.65	18.27	19.63
HLS 2016-180		18				55	4	3,960	18.60	19.21	19.85	20.54	22.08
HLS 2016-200		20				55	4	3,960	20.67	21.34	22.05	22.82	No Interference
HLS 2016-260		26				60	4	6,120	26.85	27.73	28.66	29.65	No Interference

Model Number	Outside Diameter ϕD	Effective Length ℓ_1	Length of Cut ℓ	Neck Diameter ϕd_1	Shank Taper Angle Bta	Overall Length L	Shank Diameter ϕd	Price ¥	Effective Length by Inclined Angles				
									30'	1°	1° 30'	2°	3°
HLS 2018-060	1.8	6	2.7	1.71	16°	45	4	3,960	6.23	6.43	6.65	6.88	7.40
HLS 2018-080		8				45	4	3,960	8.29	8.56	8.85	9.16	9.85
HLS 2018-100		10				45	4	3,960	10.35	10.69	11.05	11.43	12.29
HLS 2018-120		12				45	4	3,960	12.42	12.82	13.25	13.71	14.74
HLS 2018-140		14				50	4	3,960	14.48	14.95	15.45	15.99	17.19
HLS 2018-160		16				50	4	3,960	16.54	17.08	17.65	18.27	19.63
HLS 2018-180		18				55	4	3,960	18.60	19.21	19.85	20.54	No Interference
HLS 2018-200		20				55	4	3,960	20.67	21.34	22.05	22.82	No Interference
HLS 2018-250		25				60	4	5,520	25.82	26.66	27.56	28.52	No Interference
HLS 2020-060		2				6	3	1.91	16°	45	4	3,840	6.23
HLS 2020-080	8		45	4	3,840	8.29				8.56	8.85	9.16	9.85
HLS 2020-100	10		45	4	3,840	10.35				10.69	11.05	11.44	12.29
HLS 2020-120	12		45	4	3,840	12.42				12.82	13.25	13.71	14.74
HLS 2020-140	14		50	4	3,840	14.48				14.95	15.45	15.99	17.19
HLS 2020-160	16		50	4	3,840	16.54				17.08	17.65	18.27	No Interference
HLS 2020-180	18		55	4	3,840	18.61				19.21	19.86	20.55	No Interference
HLS 2020-200	20		55	4	3,840	20.67				21.34	22.05	22.82	No Interference
HLS 2020-250	25		60	4	3,840	25.83				26.66	27.56	28.52	No Interference
HLS 2020-300	30		70	4	4,680	30.98				31.99	33.06	No Interference	No Interference
HLS 2020-350	35		80	4	5,640	36.14				37.31	38.56	No Interference	No Interference
HLS 2020-400	40		90	4	7,080	41.30				42.64	No Interference	No Interference	No Interference
HLS 2020-500	50		100	4	8,520	51.61				53.28	No Interference	No Interference	No Interference
HLS 2020-600	60		110	4	10,200	61.92				No Interference	No Interference	No Interference	No Interference
HLS 2025-080	2.5		8	3.7	2.41	16°				45	4	3,960	8.29
HLS 2025-100		10	45				4	3,960	10.35	10.69	11.05	11.44	12.29
HLS 2025-120		12	45				4	3,960	12.42	12.82	13.25	13.71	No Interference
HLS 2025-140		14	50				4	3,960	14.48	14.95	15.45	15.99	No Interference
HLS 2025-160		16	50				4	3,960	16.54	17.08	17.65	18.27	No Interference
HLS 2025-180		18	55				4	3,960	18.61	19.21	19.86	20.55	No Interference
HLS 2025-200		20	55				4	3,960	20.67	21.34	22.06	No Interference	No Interference
HLS 2025-250		25	60				4	4,320	25.83	26.66	27.56	No Interference	No Interference
HLS 2025-300		30	70				4	4,320	30.98	31.99	No Interference	No Interference	No Interference
HLS 2025-400		40	90				4	6,000	41.30	42.64	No Interference	No Interference	No Interference
HLS 2025-500	50	100	4	7,440	51.61	No Interference	No Interference	No Interference	No Interference				

- UDC Series
- CBN Series
- Square
- Long Neck Square
- Radius
- Long Neck Radius
- Taper Neck Radius
- Ball / Long Shank Ball
- Long Neck Ball
- Taper Neck Ball
- Taper
- Spiral V Cutter
- Drill
- EURO Series
- Technical Data

Model Number	Outside Diameter ϕD	Effective Length ℓ_1	Length of Cut ℓ	Neck Diameter ϕd_1	Shank Taper Angle Bta	Overall Length L	Shank Diameter ϕd	Price ¥	Effective Length by Inclined Angles				
									30°	1°	1° 30'	2°	3°
HLS 2030-080	3	8	4.5	2.92	16°	45	6	5,160	8.29	8.56	8.85	9.16	9.84
HLS 2030-100		10				45	6	5,160	10.35	10.69	11.05	11.43	12.29
HLS 2030-120		12				50	6	5,160	12.41	12.82	13.25	13.71	14.74
HLS 2030-140		14				50	6	5,160	14.48	14.95	15.45	15.99	17.18
HLS 2030-160		16				60	6	5,160	16.54	17.08	17.65	18.26	19.63
HLS 2030-180		18				60	6	5,160	18.60	19.21	19.85	20.54	22.08
HLS 2030-200		20				60	6	5,160	20.66	21.34	22.05	22.82	24.53
HLS 2030-250		25				70	6	5,160	25.82	26.66	27.56	28.51	No Interference
HLS 2030-300		30				80	6	6,120	30.98	31.98	33.06	34.21	No Interference
HLS 2030-350		35				80	6	6,360	36.14	37.31	38.56	39.90	No Interference
HLS 2030-400		40				90	6	6,360	41.29	42.63	44.06	No Interference	No Interference
HLS 2030-500		50				100	6	8,880	51.61	53.28	55.07	No Interference	No Interference
HLS 2040-120	4	12	6	3.82	16°	50	6	5,880	12.59	13.00	13.44	13.91	14.95
HLS 2040-160		16				60	6	5,880	16.72	17.26	17.84	18.46	No Interference
HLS 2040-200		20				60	6	5,880	20.84	21.52	22.24	23.02	No Interference
HLS 2040-250		25				70	6	5,880	26.00	26.85	27.75	28.71	No Interference
HLS 2040-300		30				70	6	5,880	31.16	32.17	33.25	No Interference	No Interference
HLS 2040-350		35				80	6	5,880	36.32	37.49	38.75	No Interference	No Interference
HLS 2040-400		40				90	6	7,440	41.47	42.82	No Interference	No Interference	No Interference
HLS 2040-450		45				90	6	9,000	46.63	48.14	No Interference	No Interference	No Interference
HLS 2040-500		50				100	6	11,040	51.79	53.47	No Interference	No Interference	No Interference
HLS 2040-600		60				110	6	13,680	62.10	No Interference	No Interference	No Interference	No Interference
HLS 2050-160	5	16	7.5	4.82	16°	60	6	7,440	16.72	17.26	17.84	No Interference	No Interference
HLS 2050-200		20				60	6	7,440	20.84	21.52	No Interference	No Interference	No Interference
HLS 2050-250		25				60	6	7,440	26.00	26.85	No Interference	No Interference	No Interference
HLS 2050-300		30				80	6	7,440	31.16	No Interference	No Interference	No Interference	No Interference
HLS 2050-350		35				80	6	7,440	36.32	No Interference	No Interference	No Interference	No Interference
HLS 2050-400		40				80	6	7,440	41.47	No Interference	No Interference	No Interference	No Interference
HLS 2050-500		50				110	6	11,760	51.79	No Interference	No Interference	No Interference	No Interference
HLS 2050-600		60				120	6	14,400	No Interference	No Interference	No Interference	No Interference	No Interference
HLS 2060-200	6	20	9	5.82	—	80	6	7,680	No Interference	No Interference	No Interference	No Interference	No Interference
HLS 2060-300		30				80	6	7,920	No Interference	No Interference	No Interference	No Interference	No Interference
HLS 2060-400		40				100	6	9,240	No Interference	No Interference	No Interference	No Interference	No Interference
HLS 2060-500		50				120	6	11,760	No Interference	No Interference	No Interference	No Interference	No Interference
HLS 2060-600		60				120	6	15,000	No Interference	No Interference	No Interference	No Interference	No Interference

UDC Series

CBN Series

Square

Long Neck Square

Radius

Long Neck Radius

Taper Neck Radius

Ball / Long Shank Ball

Long Neck Ball

Taper Neck Ball

Taper

Spiral V Cutter

Drill

EURO Series

Technical Data

Milling Conditions for HLS (2 Flutes)

WORK MATERIAL			CARBON STEELS S45C / S50C (~225HB)				ALLOY STEELS SK / SCM / SUS (225~325HB)				PREHARDENED STEELS HARDENED STEELS NAK / SKD(30~45HRC)				
Model Number	Outside Diameter (mm)	Effective Length (mm)	Spindle Speed (min ⁻¹)	Feed Rate (mm/min)	a _p Axial Depth (mm)	a _e Radial Depth (mm)	Spindle Speed (min ⁻¹)	Feed Rate (mm/min)	a _p Axial Depth (mm)	a _e Radial Depth (mm)	Spindle Speed (min ⁻¹)	Feed Rate (mm/min)	a _p Axial Depth (mm)	a _e Radial Depth (mm)	
UDC Series	2001	0.1	0.3	30,000	30	0.003~0.005	0.035	30,000	15	0.002~0.005	0.035	30,000	16	0.001~0.004	0.035
			0.5	28,000	28	0.002~0.005	0.03	28,000	14	0.002~0.004	0.03	28,000	14	0.001~0.003	0.03
			0.75	26,000	26	0.002~0.003	0.01	26,000	13	0.001~0.002	0.01	26,000	13	0.001~0.002	0.01
			1	24,000	24	0.002~0.003	0.005	24,000	12	0.001~0.002	0.005	24,000	12	0.001~0.002	0.005
CBN Series	20015	0.15	0.5	30,000	90	0.004~0.007	0.07	30,000	80	0.003~0.006	0.07	30,000	70	0.003~0.005	0.07
			0.75	28,700	90	0.003~0.007	0.032	28,700	80	0.002~0.006	0.032	28,700	70	0.002~0.005	0.032
			1	27,300	80	0.002~0.006	0.015	27,300	70	0.001~0.005	0.015	27,300	60	0.001~0.004	0.015
Square Long Neck Square	2002	0.2	0.5	56,000	340	0.005~0.009	0.13	56,000	310	0.005~0.008	0.13	56,000	270	0.004~0.006	0.13
			1	50,900	290	0.003~0.007	0.035	50,900	260	0.003~0.006	0.035	50,900	230	0.002~0.004	0.035
			1.5	48,200	250	0.003~0.004	0.012	48,200	230	0.002~0.003	0.012	48,200	200	0.001~0.002	0.012
			2	43,500	190	0.001~0.002	0.003	43,500	170	0.001~0.002	0.003	43,500	150	0.001~0.002	0.003
			3	41,300	160	0.001~0.001	0.002	41,300	145	0.001~0.001	0.002	41,300	130	0.001~0.001	0.002
Radius Long Neck Radius Taper Neck Radius	2003	0.3	1	60,000	560	0.009~0.015	0.101	60,000	500	0.008~0.013	0.101	60,000	440	0.006~0.01	0.101
			1.5	50,800	460	0.008~0.013	0.05	50,800	410	0.007~0.011	0.05	50,800	360	0.005~0.009	0.05
			2	41,500	350	0.006~0.01	0.023	41,500	320	0.005~0.009	0.023	41,500	280	0.004~0.007	0.023
			2.5	36,700	300	0.004~0.005	0.012	36,700	270	0.004~0.006	0.012	36,700	240	0.003~0.005	0.012
			3	31,900	240	0.002~0.004	0.008	31,900	220	0.002~0.003	0.008	31,900	190	0.001~0.002	0.008
			4	26,200	170	0.001~0.002	0.003	26,200	160	0.001~0.002	0.003	26,200	140	0.001~0.001	0.003
			6	20,400	100	0.001~0.001	—	20,400	90	0.001~0.001	—	20,400	80	0.001~0.001	—
Ball / Long Neck Ball Long Neck Ball Taper Neck Ball	2004	0.4	1.5	52,700	660	0.011~0.016	0.095	57,700	640	0.009~0.015	0.095	48,100	470	0.007~0.012	0.095
			2	50,000	610	0.009~0.014	0.052	53,000	580	0.008~0.013	0.052	44,600	430	0.006~0.01	0.052
			2.5	47,300	560	0.007~0.012	0.026	48,300	520	0.007~0.011	0.026	41,100	390	0.005~0.008	0.026
			3	44,500	510	0.005~0.009	0.018	43,600	450	0.005~0.008	0.018	37,500	340	0.004~0.006	0.018
			3.5	42,800	480	0.005~0.008	0.01	40,800	410	0.004~0.009	0.01	35,300	310	0.004~0.005	0.01
			4	41,000	440	0.004~0.006	0.008	38,000	360	0.003~0.005	0.008	33,100	280	0.003~0.004	0.008
			5	38,500	380	0.003~0.004	0.004	34,200	300	0.002~0.004	0.004	30,100	240	0.002~0.003	0.004
			8	33,700	260	0.001~0.002	0.001	27,300	190	0.001~0.002	0.001	24,600	150	0.001~0.002	0.001
Taper Spiral V Cutter	2005	0.5	1.5	63,100	1,020	0.019~0.029	0.139	61,000	870	0.017~0.027	0.139	46,500	610	0.013~0.02	0.139
			2	56,800	900	0.015~0.025	0.098	54,000	760	0.014~0.023	0.098	40,600	510	0.011~0.018	0.098
			2.5	50,500	780	0.011~0.021	0.057	47,000	650	0.011~0.019	0.057	34,700	410	0.009~0.016	0.057
			3	44,200	660	0.007~0.016	0.037	39,900	530	0.008~0.015	0.037	32,200	370	0.007~0.011	0.037
			4	40,600	580	0.008~0.013	0.016	36,100	460	0.007~0.012	0.016	29,700	330	0.006~0.009	0.016
			5	37,000	500	0.006~0.01	0.008	32,300	390	0.006~0.009	0.008	27,200	290	0.005~0.007	0.008
			6	33,400	420	0.004~0.007	0.005	28,500	320	0.004~0.006	0.005	24,700	250	0.003~0.005	0.005
			8	29,100	320	0.002~0.003	0.002	24,100	240	0.002~0.003	0.002	21,600	190	0.001~0.003	0.002
			10	26,100	250	0.001~0.002	0.001	21,200	180	0.001~0.002	0.001	19,600	150	0.001~0.002	0.001
			15	21,500	120	0.001~0.001	—	16,700	80	0.001~0.001	—	16,300	70	0.001~0.001	—
EURO Series Technical Data	2006	0.6	2	63,600	1,240	0.023~0.038	0.18	53,300	930	0.02~0.034	0.18	39,100	600	0.016~0.026	0.18
			3	52,500	990	0.018~0.03	0.075	44,000	740	0.016~0.026	0.075	33,500	500	0.013~0.02	0.075
			4	41,300	740	0.012~0.021	0.03	34,700	550	0.011~0.018	0.03	27,900	390	0.009~0.014	0.03
			5	36,700	630	0.01~0.017	0.017	30,900	470	0.009~0.014	0.017	25,500	340	0.007~0.011	0.017
			6	32,100	520	0.007~0.012	0.01	27,000	390	0.006~0.01	0.01	23,000	290	0.005~0.008	0.01
			7	29,500	460	0.006~0.01	0.005	24,800	350	0.005~0.008	0.005	21,500	260	0.004~0.006	0.005
			8	26,800	390	0.004~0.007	0.004	22,600	300	0.004~0.006	0.004	20,000	230	0.003~0.005	0.004
			10	23,400	300	0.002~0.004	0.002	19,700	230	0.002~0.004	0.002	17,900	180	0.002~0.003	0.002
			12	20,900	240	0.002~0.003	0.001	17,600	180	0.002~0.002	0.001	16,400	150	0.001~0.002	0.001
			18	16,200	100	0.001~0.001	—	13,700	80	0.001~0.001	—	13,500	70	0.001~0.001	—

Milling Conditions for HLS (2 Flutes)

WORK MATERIAL			HARDENED STEELS SKD / SKT (45~55HRC)				HARDENED STEELS SKD / SKH (55~60HRC)			
Model Number	Outside Diameter (mm)	Effective Length (mm)	Spindle Speed (min ⁻¹)	Feed Rate (mm/min)	a _p Axial Depth (mm)	a _e Radial Depth (mm)	Spindle Speed (min ⁻¹)	Feed Rate (mm/min)	a _p Axial Depth (mm)	a _e Radial Depth (mm)
2001	0.1	0.3	—	—	— ~ —	0.035	—	—	— ~ —	0.035
		0.5	—	—	— ~ —	0.03	—	—	— ~ —	0.03
		0.75	—	—	— ~ —	—	—	—	— ~ —	—
		1	—	—	— ~ —	—	—	—	— ~ —	—
20015	0.15	0.5	30,000	50	0.003~0.004	0.07	—	—	— ~ —	0.07
		0.75	28,700	50	0.002~0.004	0.032	—	—	— ~ —	0.032
		1	27,300	40	0.001~0.003	0.015	—	—	— ~ —	0.015
2002	0.2	0.5	44,800	180	0.003~0.004	0.13	15,000	10	0.001~0.002	0.13
		1	40,800	160	0.001~0.002	0.035	—	—	— ~ —	0.035
		1.5	38,500	140	0.001~0.001	0.012	—	—	— ~ —	0.012
		2	34,500	100	0.001~0.001	0.003	—	—	— ~ —	—
		3	32,600	80	0.001~0.001	0.002	—	—	— ~ —	—
2003	0.3	1	52,100	330	0.004~0.007	0.101	14,600	14	0.003~0.004	0.101
		1.5	42,700	260	0.004~0.006	0.05	14,600	13	0.003~0.004	0.05
		2	33,200	190	0.003~0.005	0.023	14,600	12	0.002~0.003	0.023
		2.5	29,400	160	0.002~0.004	0.012	14,600	11	0.001~0.002	0.012
		3	25,500	130	0.001~0.002	0.008	14,600	10	0.001~0.001	0.008
		4	20,900	100	0.001~0.001	0.003	14,600	9	0.001~0.001	0.003
		6	16,300	60	0.001~0.001	—	—	—	— ~ —	—
2004	0.4	1.5	38,500	320	0.004~0.008	0.095	14,300	17	0.003~0.004	0.095
		2	35,700	290	0.004~0.007	0.052	14,300	17	0.003~0.004	0.052
		2.5	32,900	260	0.004~0.006	0.026	14,300	17	0.003~0.004	0.026
		3	30,000	230	0.003~0.005	0.018	14,300	16	0.002~0.003	0.018
		3.5	28,300	210	0.003~0.004	0.01	14,300	16	0.002~0.003	0.01
		4	26,500	190	0.002~0.003	0.008	14,300	15	0.001~0.002	0.008
		5	24,100	160	0.001~0.002	0.004	14,300	14	0.001~0.001	0.004
		8	19,700	100	0.001~0.001	0.001	14,300	11	0.001~0.001	0.001
2005	0.5	1.5	37,300	410	0.009~0.015	0.139	14,000	20	0.004~0.008	0.139
		2	32,500	350	0.008~0.013	0.098	14,000	20	0.004~0.007	0.098
		2.5	27,700	290	0.007~0.011	0.057	14,000	20	0.004~0.006	0.057
		3	25,700	260	0.005~0.009	0.037	14,000	19	0.004~0.005	0.037
		4	23,700	230	0.004~0.007	0.016	14,000	18	0.003~0.004	0.016
		5	21,700	200	0.003~0.005	0.008	14,000	17	0.002~0.003	0.008
		6	19,700	170	0.002~0.003	0.005	14,000	16	0.001~0.002	0.005
		8	17,300	130	0.001~0.002	0.002	14,000	14	0.001~0.001	0.002
		10	15,600	100	0.001~0.001	0.001	14,000	12	0.001~0.001	0.001
2006	0.6	15	13,000	50	0.001~0.001	—	—	—	— ~ —	—
		2	31,300	410	0.011~0.019	0.18	12,000	23	0.006~0.01	0.18
		3	26,800	340	0.009~0.015	0.075	12,000	22	0.005~0.008	0.075
		4	22,300	270	0.006~0.01	0.03	12,000	21	0.003~0.005	0.03
		5	20,400	240	0.005~0.008	0.017	12,000	20	0.003~0.004	0.017
		6	18,400	200	0.003~0.006	0.01	12,000	19	0.002~0.003	0.01
		7	17,200	180	0.003~0.005	0.005	12,000	18	0.002~0.003	0.005
		8	16,000	160	0.002~0.003	0.004	12,000	17	0.001~0.002	0.004
		10	14,300	130	0.001~0.002	0.002	12,000	15	0.001~0.001	0.002
		12	13,100	100	0.001~0.001	0.001	12,000	13	0.001~0.001	0.001
18	10,800	50	0.001~0.001	—	—	—	— ~ —	—		

UDC Series

CBN Series

Square

Long Neck Square

Radius

Radius

Long Neck Radius

Taper Neck Radius

Ball / Long Shank Ball

Ball

Long Neck Ball

Taper Neck Ball

Taper

Taper

Spiral V Cutter

Drill

EURO Series

Technical Data

Milling Conditions for HLS (2 Flutes)

WORK MATERIAL			CARBON STEELS S45C / S50C (~225HB)				ALLOY STEELS SK / SCM / SUS (225~325HB)				PREHARDENED STEELS HARDENED STEELS NAK / SKD(30~45HRC)							
Model Number	Outside Diameter (mm)	Effective Length (mm)	Spindle Speed (min ⁻¹)	Feed Rate (mm/min)	a _p Axial Depth (mm)	a _e Radial Depth (mm)	Spindle Speed (min ⁻¹)	Feed Rate (mm/min)	a _p Axial Depth (mm)	a _e Radial Depth (mm)	Spindle Speed (min ⁻¹)	Feed Rate (mm/min)	a _p Axial Depth (mm)	a _e Radial Depth (mm)				
UDC Series	2007	0.7	2	59,800	1,380	0.03 ~0.05	0.165	50,200	1,040	0.027~0.045	0.165	36,100	660	0.021~0.035	0.165			
			4	38,900	840	0.017~0.029	0.047	32,700	630	0.015~0.026	0.047	25,800	440	0.012~0.02	0.047			
			6	30,200	600	0.01 ~0.017	0.014	25,400	450	0.009~0.015	0.014	21,200	330	0.007~0.012	0.014			
			8	25,300	460	0.006~0.01	0.006	21,300	350	0.005~0.009	0.006	18,400	260	0.004~0.007	0.006			
			10	22,000	360	0.004~0.006	0.004	18,500	270	0.003~0.005	0.004	16,500	220	0.003~0.005	0.004			
CBN Series	2008	0.8	3	41,200	1,050	0.033~0.053	0.15	34,500	790	0.029~0.049	0.15	26,200	530	0.023~0.038	0.15			
			4	37,100	930	0.027~0.044	0.08	31,100	700	0.024~0.04	0.08	24,100	480	0.019~0.031	0.08			
			5	33,000	810	0.021~0.035	0.052	27,700	610	0.019~0.031	0.052	22,000	430	0.015~0.024	0.052			
			6	28,800	680	0.015~0.025	0.024	24,200	510	0.013~0.022	0.024	19,800	370	0.01 ~0.017	0.024			
			8	24,100	520	0.009~0.015	0.01	20,300	390	0.008~0.013	0.01	17,200	300	0.006~0.01	0.01			
			10	21,000	420	0.006~0.009	0.005	17,700	320	0.005~0.008	0.005	15,500	240	0.004~0.007	0.005			
			12	18,700	340	0.004~0.006	0.003	15,800	260	0.003~0.006	0.003	14,100	200	0.003~0.004	0.003			
			16	15,600	230	0.002~0.003	0.001	13,200	180	0.002~0.003	0.001	12,300	150	0.002~0.002	0.001			
			24	12,100	100	0.001~0.002	—	10,300	80	0.001~0.002	—	10,100	70	0.001~0.001	—			
Radius	2009	0.9	4	35,600	1,100	0.033~0.054	0.128	29,500	820	0.029~0.049	0.128	22,500	550	0.023~0.038	0.128			
			6	27,600	790	0.019~0.032	0.038	23,000	590	0.017~0.029	0.038	18,500	420	0.013~0.022	0.038			
			8	23,000	600	0.012~0.02	0.016	19,300	450	0.011~0.018	0.016	16,100	330	0.008~0.014	0.016			
			10	20,000	470	0.008~0.013	0.008	16,800	360	0.007~0.012	0.008	14,500	270	0.005~0.009	0.008			
			15	15,500	270	0.003~0.006	0.002	13,100	200	0.003~0.005	0.002	11,900	160	0.002~0.004	0.002			
Long Neck Radius	2010	1	3	37,900	1,340	0.048~0.067	0.263	31,500	990	0.043~0.072	0.263	23,400	650	0.034~0.057	0.263			
			4	34,100	1,170	0.04 ~0.067	0.195	28,400	870	0.036~0.06	0.195	21,500	580	0.028~0.047	0.195			
			5	30,300	1,000	0.032~0.053	0.127	25,300	750	0.029~0.048	0.127	19,600	510	0.022~0.037	0.127			
			6	26,500	850	0.023~0.039	0.058	22,100	630	0.021~0.035	0.058	17,600	440	0.016~0.027	0.058			
			7	24,300	760	0.019~0.032	0.041	20,400	560	0.017~0.029	0.041	16,500	400	0.013~0.022	0.041			
			8	22,100	660	0.014~0.024	0.024	18,600	490	0.013~0.022	0.024	15,300	360	0.01 ~0.017	0.024			
			9	20,700	600	0.012~0.02	0.019	17,400	450	0.011~0.018	0.019	14,600	330	0.009~0.014	0.019			
			10	19,200	530	0.01 ~0.016	0.013	16,200	400	0.009~0.014	0.013	13,800	300	0.007~0.011	0.013			
			12	17,200	440	0.007~0.011	0.007	14,500	330	0.006~0.01	0.007	12,600	250	0.005~0.008	0.007			
			14	15,600	360	0.005~0.008	0.005	13,200	270	0.004~0.007	0.005	11,700	210	0.003~0.006	0.005			
			16	14,300	300	0.004~0.006	0.003	12,100	230	0.003~0.006	0.003	11,000	180	0.003~0.005	0.003			
			18	13,400	250	0.003~0.005	0.002	11,350	190	0.002~0.004	0.002	10,400	150	0.002~0.004	0.002			
			20	12,500	200	0.002~0.004	0.002	10,600	160	0.002~0.003	0.002	9,800	130	0.002~0.003	0.002			
			25	10,800	120	0.002~0.003	0.001	9,200	100	0.001~0.002	0.001	8,800	80	0.001~0.002	0.001			
			30	9,700	80	0.001~0.002	—	8,200	60	0.001~0.002	—	8,100	50	0.001~0.002	—			
			Ball / Long Shank Ball	2012	1.2	4	28,900	1,180	0.05 ~0.085	0.23	24,100	870	0.047~0.077	0.23	18,300	580	0.036~0.059	0.23
						6	24,800	970	0.037~0.062	0.12	20,700	720	0.034~0.056	0.12	16,100	490	0.026~0.043	0.12
8	20,700	760				0.024~0.039	0.051	17,300	570	0.021~0.035	0.051	13,900	400	0.016~0.027	0.051			
10	18,000	620				0.016~0.026	0.026	15,100	470	0.014~0.023	0.026	12,400	340	0.011~0.018	0.026			
12	16,100	520				0.011~0.018	0.015	13,500	390	0.01 ~0.016	0.015	11,400	290	0.008~0.013	0.015			
16	13,400	380				0.006~0.01	0.006	11,300	290	0.005~0.009	0.006	9,800	220	0.004~0.007	0.006			
20	11,700	280				0.004~0.007	0.003	9,900	210	0.004~0.006	0.003	8,800	170	0.003~0.005	0.003			
Long Neck Ball	2014	1.4	6	23,300	1,070	0.052~0.086	0.222	19,400	800	0.047~0.078	0.222	14,800	540	0.036~0.061	0.222			
			8	19,500	850	0.035~0.059	0.094	16,300	640	0.032~0.053	0.094	12,900	440	0.025~0.041	0.094			
			10	16,900	710	0.025~0.041	0.048	14,200	530	0.022~0.037	0.048	11,500	380	0.017~0.029	0.048			
			12	15,100	600	0.018~0.03	0.028	12,700	450	0.016~0.027	0.028	10,500	330	0.013~0.021	0.028			
			14	13,700	510	0.013~0.022	0.018	11,500	390	0.012~0.02	0.018	9,700	290	0.009~0.016	0.018			
			16	12,600	450	0.01 ~0.017	0.012	10,600	340	0.009~0.015	0.012	9,100	250	0.007~0.012	0.012			
			22	10,300	300	0.006~0.009	0.004	8,700	230	0.005~0.008	0.004	7,800	180	0.004~0.006	0.004			
Taper Neck Radius	2010	1	3	37,900	1,340	0.048~0.067	0.263	31,500	990	0.043~0.072	0.263	23,400	650	0.034~0.057	0.263			
Ball	2010	1	3	37,900	1,340	0.048~0.067	0.263	31,500	990	0.043~0.072	0.263	23,400	650	0.034~0.057	0.263			
Taper	2010	1	3	37,900	1,340	0.048~0.067	0.263	31,500	990	0.043~0.072	0.263	23,400	650	0.034~0.057	0.263			
Spiral V Cutter	2010	1	3	37,900	1,340	0.048~0.067	0.263	31,500	990	0.043~0.072	0.263	23,400	650	0.034~0.057	0.263			
Drill	2012	1.2	4	28,900	1,180	0.05 ~0.085	0.23	24,100	870	0.047~0.077	0.23	18,300	580	0.036~0.059	0.23			
EURO Series	2012	1.2	4	28,900	1,180	0.05 ~0.085	0.23	24,100	870	0.047~0.077	0.23	18,300	580	0.036~0.059	0.23			
Technical Data	2014	1.4	6	23,300	1,070	0.052~0.086	0.222	19,400	800	0.047~0.078	0.222	14,800	540	0.036~0.061	0.222			

Milling Conditions for HLS (2 Flutes)

WORK MATERIAL			HARDENED STEELS SKD / SKT (45~55HRC)				HARDENED STEELS SKD / SKH (55~60HRC)			
Model Number	Outside Diameter (mm)	Effective Length (mm)	Spindle Speed (min ⁻¹)	Feed Rate (mm/min)	a _p Axial Depth (mm)	a _e Radial Depth (mm)	Spindle Speed (min ⁻¹)	Feed Rate (mm/min)	a _p Axial Depth (mm)	a _e Radial Depth (mm)
2007	0.7	2	28,800	430	0.015~0.025	0.165	10,000	24	0.01 ~0.015	0.165
		4	20,600	290	0.009~0.014	0.047	10,000	22	0.006~0.009	0.047
		6	16,900	230	0.005~0.008	0.014	10,000	20	0.003~0.005	0.014
		8	14,700	190	0.003~0.005	0.006	10,000	18	0.002~0.003	0.006
		10	13,200	160	0.002~0.003	0.004	10,000	13	0.001~0.002	0.004
2008	0.8	3	21,000	370	0.016~0.027	0.15	8,000	21	0.012~0.016	0.15
		4	19,300	330	0.013~0.022	0.08	8,000	20	0.01 ~0.013	0.08
		5	17,600	290	0.01 ~0.017	0.052	8,000	19	0.008~0.01	0.052
		6	15,800	250	0.007~0.012	0.024	8,000	18	0.005~0.007	0.024
		8	13,800	200	0.004~0.007	0.01	8,000	16	0.003~0.004	0.01
		10	12,400	170	0.003~0.005	0.005	8,000	14	0.002~0.003	0.005
		12	11,300	140	0.002~0.003	0.003	8,000	12	0.001~0.002	0.003
		16	9,800	100	0.001~0.002	0.001	—	—	— ~ —	0.001
2009	0.9	4	18,000	380	0.016~0.027	0.128	7,200	20	0.01 ~0.014	0.128
		6	14,800	290	0.01 ~0.016	0.038	7,200	18	0.007~0.009	0.038
		8	12,900	230	0.006~0.01	0.016	7,200	16	0.004~0.006	0.016
		10	11,600	190	0.004~0.006	0.008	7,200	14	0.002~0.003	0.008
		15	9,500	120	0.002~0.003	0.002	—	—	— ~ —	0.002
2010	1	3	18,700	440	0.024~0.039	0.263	6,500	15	0.011~0.016	0.263
		4	17,200	400	0.02 ~0.033	0.195	6,500	15	0.01 ~0.015	0.195
		5	15,700	360	0.016~0.027	0.127	6,500	15	0.009~0.014	0.127
		6	14,100	310	0.012~0.02	0.058	6,500	14	0.007~0.012	0.058
		7	13,200	280	0.01 ~0.016	0.041	6,500	14	0.006~0.009	0.041
		8	12,300	250	0.007~0.012	0.024	6,500	13	0.004~0.006	0.024
		9	11,700	230	0.006~0.01	0.019	6,500	13	0.004~0.005	0.019
		10	11,000	210	0.005~0.008	0.013	6,500	12	0.003~0.004	0.013
		12	10,100	170	0.003~0.006	0.007	6,500	11	0.002~0.003	0.007
		14	9,400	150	0.002~0.004	0.005	6,500	10	0.001~0.002	0.005
		16	8,800	130	0.002~0.003	0.003	—	—	— ~ —	0.003
		18	8,350	110	0.001~0.002	0.002	—	—	— ~ —	0.002
		20	7,900	90	0.001~0.002	0.002	—	—	— ~ —	0.002
25	7,100	60	0.001~0.001	0.001	—	—	— ~ —	0.001		
30	6,500	40	0.001~0.001	—	—	—	— ~ —	—		
2012	1.2	4	14,500	400	0.026~0.042	0.23	9,600	34	0.015~0.026	0.23
		6	12,800	340	0.019~0.031	0.12	9,600	22	0.011~0.019	0.12
		8	11,100	280	0.012~0.02	0.051	9,600	10	0.007~0.012	0.051
		10	9,900	230	0.008~0.013	0.026	—	—	— ~ —	0.026
		12	9,100	200	0.005~0.009	0.015	—	—	— ~ —	0.015
		16	7,900	150	0.003~0.005	0.006	—	—	— ~ —	0.006
20	7,000	120	0.002~0.003	0.003	—	—	— ~ —	0.003		
2014	1.4	6	11,900	370	0.026~0.043	0.222	9,600	44	0.015~0.026	0.222
		8	10,300	310	0.018~0.029	0.094	9,600	18	0.01 ~0.017	0.094
		10	9,200	260	0.012~0.021	0.048	—	—	— ~ —	0.048
		12	8,400	230	0.009~0.015	0.028	—	—	— ~ —	0.028
		14	7,800	200	0.007~0.011	0.018	—	—	— ~ —	0.018
		16	7,300	180	0.005~0.009	0.012	—	—	— ~ —	0.012
		22	6,200	120	0.003~0.005	0.004	—	—	— ~ —	0.004

UDC Series

CBN Series

Square

Long Neck Square

Radius

Long Neck Radius

Taper Neck Radius

Ball / Long Shank Ball

Long Neck Ball

Taper Neck Ball

Taper

Spiral V Cutter

Drill

EURO Series

Technical Data

Milling Conditions for HLS (2 Flutes)

WORK MATERIAL			CARBON STEELS S45C / S50C (~225HB)				ALLOY STEELS SK / SCM / SUS (225~325HB)				PREHARDENED STEELS HARDENED STEELS NAK / SKD(30~45HRC)				
Model Number	Outside Diameter (mm)	Effective Length (mm)	Spindle Speed (min ⁻¹)	Feed Rate (mm/min)	a _p Axial Depth (mm)	a _e Radial Depth (mm)	Spindle Speed (min ⁻¹)	Feed Rate (mm/min)	a _p Axial Depth (mm)	a _e Radial Depth (mm)	Spindle Speed (min ⁻¹)	Feed Rate (mm/min)	a _p Axial Depth (mm)	a _e Radial Depth (mm)	
UDC Series	2015	1.5	4	26,600	1,340	0.073~0.12	0.462	22,100	1,000	0.065~0.109	0.462	16,300	640	0.051~0.084	0.462
			6	22,800	1,120	0.057~0.094	0.293	19,000	840	0.051~0.085	0.293	14,400	550	0.04~0.066	0.293
			8	19,000	900	0.041~0.068	0.124	15,900	670	0.037~0.061	0.124	12,500	460	0.029~0.048	0.124
			10	16,600	750	0.03~0.05	0.063	13,800	560	0.027~0.045	0.063	11,200	390	0.021~0.035	0.063
			12	14,800	630	0.023~0.038	0.037	12,400	470	0.02~0.034	0.037	10,200	340	0.016~0.026	0.037
			14	13,400	550	0.017~0.029	0.023	11,200	410	0.016~0.026	0.023	9,500	300	0.012~0.02	0.023
			16	12,300	480	0.013~0.022	0.015	10,300	360	0.012~0.02	0.015	8,900	270	0.009~0.016	0.015
			18	11,500	420	0.011~0.018	0.011	9,600	310	0.01~0.016	0.011	8,400	240	0.007~0.012	0.011
			20	10,700	370	0.009~0.014	0.008	9,000	280	0.008~0.013	0.008	7,900	220	0.006~0.01	0.008
			25	9,300	270	0.005~0.009	0.004	7,800	200	0.005~0.008	0.004	7,100	160	0.004~0.006	0.004
			30	8,300	200	0.004~0.007	0.002	7,000	150	0.004~0.006	0.002	6,500	120	0.003~0.005	0.002
			35	7,600	140	0.003~0.004	0.001	6,400	110	0.003~0.004	0.001	6,000	90	0.002~0.003	0.001
40	7,000	90	0.002~0.003	0.001	5,800	70	0.002~0.003	0.001	5,600	60	0.002~0.002	0.001			
45	6,500	60	0.002~0.003	0.001	5,400	50	0.002~0.002	0.001	5,300	40	0.001~0.002	0.001			
Radius	2016	1.6	6	22,200	1,170	0.065~0.108	0.379	18,500	870	0.058~0.097	0.379	13,800	570	0.045~0.076	0.379
			8	18,500	940	0.047~0.079	0.16	15,500	700	0.042~0.071	0.16	12,000	480	0.033~0.055	0.16
			10	16,100	780	0.035~0.058	0.082	13,500	580	0.032~0.053	0.082	10,800	410	0.025~0.041	0.082
			12	14,400	670	0.027~0.044	0.047	12,000	500	0.024~0.04	0.047	9,800	360	0.019~0.031	0.047
			14	13,000	580	0.02~0.034	0.03	10,900	430	0.018~0.031	0.03	9,100	320	0.014~0.024	0.03
			16	12,000	510	0.016~0.027	0.02	10,000	380	0.014~0.024	0.02	8,500	280	0.011~0.019	0.02
			18	11,100	450	0.013~0.022	0.014	9,300	340	0.012~0.019	0.014	8,000	260	0.009~0.015	0.014
			20	10,400	400	0.011~0.018	0.01	8,700	300	0.01~0.016	0.01	7,600	230	0.007~0.012	0.01
Long Neck Radius	2018	1.8	6	21,000	1,270	0.061~0.102	0.608	17,800	950	0.055~0.092	0.608	12,800	600	0.043~0.071	0.608
			8	17,700	1,020	0.05~0.083	0.256	14,900	760	0.045~0.075	0.256	11,100	500	0.035~0.058	0.256
			10	15,400	860	0.041~0.068	0.131	12,900	640	0.037~0.061	0.131	9,900	430	0.029~0.048	0.131
			12	13,800	740	0.033~0.055	0.076	11,500	550	0.03~0.05	0.076	9,100	380	0.023~0.039	0.076
			14	12,500	640	0.027~0.045	0.048	10,500	480	0.024~0.041	0.048	8,400	340	0.019~0.032	0.048
			16	11,500	570	0.022~0.037	0.032	9,600	420	0.02~0.033	0.032	7,800	300	0.016~0.026	0.032
			18	10,700	500	0.018~0.03	0.023	8,900	380	0.016~0.027	0.023	7,400	280	0.013~0.021	0.023
			20	10,000	450	0.015~0.025	0.016	8,400	340	0.013~0.022	0.016	7,000	250	0.01~0.017	0.016
Ball / Long Shank Ball	2020	2	6	20,300	1,350	0.064~0.107	0.926	17,400	1,030	0.058~0.097	0.926	12,500	650	0.045~0.075	0.926
			8	17,000	1,090	0.054~0.089	0.391	14,500	830	0.048~0.081	0.391	10,800	540	0.038~0.063	0.391
			10	14,800	920	0.045~0.075	0.2	12,600	700	0.04~0.067	0.2	9,700	470	0.031~0.052	0.2
			12	13,200	790	0.037~0.062	0.116	11,200	600	0.034~0.056	0.116	8,900	420	0.026~0.044	0.116
			14	12,000	700	0.031~0.052	0.073	10,200	530	0.028~0.047	0.073	8,200	370	0.022~0.036	0.073
			16	11,100	620	0.026~0.044	0.049	9,400	470	0.024~0.039	0.049	7,700	340	0.018~0.03	0.049
			18	10,300	550	0.022~0.036	0.034	8,700	420	0.02~0.033	0.034	7,200	310	0.015~0.026	0.034
			20	9,600	500	0.018~0.031	0.025	8,100	380	0.016~0.027	0.025	6,900	280	0.013~0.021	0.025
Long Neck Ball	2020	2	25	8,400	390	0.012~0.02	0.013	7,100	290	0.011~0.018	0.013	6,200	230	0.008~0.014	0.013
			30	7,500	310	0.008~0.013	0.007	6,300	230	0.007~0.012	0.007	5,600	180	0.005~0.009	0.007
			35	6,800	250	0.005~0.008	0.005	5,700	190	0.005~0.008	0.005	5,200	150	0.004~0.006	0.005
			40	6,300	200	0.003~0.006	0.003	5,200	150	0.003~0.005	0.003	4,900	120	0.002~0.004	0.003
			50	5,400	110	0.003~0.004	0.002	4,500	90	0.002~0.002	0.002	4,400	70	0.002~0.002	0.002
			60	4,900	50	0.002~0.003	0.002	4,000	40	0.002~0.002	0.002	4,000	30	0.002~0.002	0.002

Milling Conditions for HLS (2 Flutes)

WORK MATERIAL			HARDENED STEELS SKD / SKT (45~55HRC)				HARDENED STEELS SKD / SKH (55~60HRC)			
Model Number	Outside Diameter (mm)	Effective Length (mm)	Spindle Speed (min ⁻¹)	Feed Rate (mm/min)	a _p Axial Depth (mm)	a _e Radial Depth (mm)	Spindle Speed (min ⁻¹)	Feed Rate (mm/min)	a _p Axial Depth (mm)	a _e Radial Depth (mm)
2015	1.5	4	13,000	440	0.036~0.06	0.462	9,600	95	0.02 ~0.036	0.462
		6	11,500	380	0.028~0.047	0.293	9,600	60	0.016~0.028	0.293
		8	10,000	320	0.02 ~0.034	0.124	9,600	25	0.012~0.02	0.124
		10	8,900	270	0.015~0.025	0.063	9,600	13	0.009~0.015	0.063
		12	8,200	240	0.011~0.019	0.037	—	—	— ~ —	0.037
		14	7,600	210	0.009~0.014	0.023	—	—	— ~ —	0.023
		16	7,100	190	0.007~0.011	0.015	—	—	— ~ —	0.015
		18	6,700	170	0.005~0.009	0.011	—	—	— ~ —	0.011
		20	6,300	150	0.004~0.007	0.008	—	—	— ~ —	0.008
		25	5,700	110	0.003~0.005	0.004	—	—	— ~ —	0.004
		30	5,200	90	0.002~0.003	0.002	—	—	— ~ —	0.002
		35	4,800	60	0.002~0.002	0.001	—	—	— ~ —	0.001
		40	4,500	40	0.001~0.002	0.001	—	—	— ~ —	0.001
		45	4,300	30	0.001~0.001	0.001	—	—	— ~ —	0.001
2016	1.6	6	11,100	400	0.032~0.054	0.379	9,600	73	0.019~0.032	0.379
		8	9,600	330	0.024~0.039	0.16	9,600	31	0.014~0.023	0.16
		10	8,600	280	0.018~0.029	0.082	9,600	15	0.01 ~0.017	0.082
		12	7,900	250	0.013~0.022	0.047	—	—	— ~ —	0.047
		14	7,300	220	0.01 ~0.017	0.03	—	—	— ~ —	0.03
		16	6,800	200	0.008~0.013	0.02	—	—	— ~ —	0.02
		18	6,400	180	0.006~0.011	0.014	—	—	— ~ —	0.014
		20	6,100	160	0.005~0.009	0.01	—	—	— ~ —	0.01
		26	5,300	120	0.003~0.005	0.005	—	—	— ~ —	0.005
2018	1.8	6	10,200	410	0.031~0.051	0.608	9,600	137	0.018~0.031	0.608
		8	8,900	350	0.025~0.042	0.256	9,600	58	0.015~0.025	0.256
		10	7,900	300	0.02 ~0.034	0.131	9,600	29	0.012~0.02	0.131
		12	7,200	260	0.017~0.028	0.076	9,600	17	0.01 ~0.017	0.076
		14	6,700	230	0.014~0.023	0.048	9,600	10	0.008~0.014	0.048
		16	6,300	210	0.011~0.019	0.032	—	—	— ~ —	0.032
		18	5,900	190	0.009~0.015	0.023	—	—	— ~ —	0.023
		20	5,600	170	0.007~0.012	0.016	—	—	— ~ —	0.016
		25	5,000	140	0.005~0.008	0.008	—	—	— ~ —	0.008
2020	2	6	10,000	450	0.032~0.054	0.926	9,600	211	0.019~0.032	0.926
		8	8,700	380	0.027~0.045	0.391	9,600	89	0.016~0.027	0.391
		10	7,800	330	0.022~0.037	0.2	9,600	45	0.013~0.022	0.2
		12	7,100	290	0.019~0.031	0.116	9,600	28	0.011~0.019	0.116
		14	6,600	260	0.016~0.026	0.073	9,600	16	0.009~0.016	0.073
		16	6,100	230	0.013~0.022	0.049	9,600	11	0.007~0.013	0.049
		18	5,800	210	0.011~0.018	0.034	—	—	— ~ —	0.034
		20	5,500	190	0.009~0.015	0.025	—	—	— ~ —	0.025
		25	4,900	160	0.006~0.01	0.013	—	—	— ~ —	0.013
		30	4,500	130	0.004~0.006	0.007	—	—	— ~ —	0.007
		35	4,200	100	0.003~0.004	0.005	—	—	— ~ —	0.005
		40	3,900	80	0.002~0.003	0.003	—	—	— ~ —	0.003
		50	3,500	50	0.001~0.001	0.002	—	—	— ~ —	0.002
60	3,200	30	0.001~0.001	0.002	—	—	— ~ —	0.002		

UDC Series

CBN Series

Square

Long Neck Square

Radius

Long Neck Radius

Taper Neck Radius

Ball / Long Shank Ball

Long Neck Ball

Taper Neck Ball

Taper

Spiral V Cutter

Drill

EURO Series

Technical Data

Milling Conditions for HLS (2 Flutes)

WORK MATERIAL			CARBON STEELS S45C / S50C (~225HB)				ALLOY STEELS SK / SCM / SUS (225~325HB)				PREHARDENED STEELS HARDENED STEELS NAK / SKD(30~45HRC)				
Model Number	Outside Diameter (mm)	Effective Length (mm)	Spindle Speed (min ⁻¹)	Feed Rate (mm/min)	a _p Axial Depth (mm)	a _e Radial Depth (mm)	Spindle Speed (min ⁻¹)	Feed Rate (mm/min)	a _p Axial Depth (mm)	a _e Radial Depth (mm)	Spindle Speed (min ⁻¹)	Feed Rate (mm/min)	a _p Axial Depth (mm)	a _e Radial Depth (mm)	
UDC Series	2025	2.5	8	15,000	1,340	0.077~0.129	0.954	12,800	1,020	0.069~0.116	0.954	9,600	670	0.054~0.09	0.954
			10	13,100	1,140	0.068~0.113	0.488	11,100	860	0.061~0.102	0.488	8,600	590	0.048~0.079	0.488
			12	11,800	1,000	0.06~0.099	0.283	10,000	750	0.054~0.089	0.283	7,900	520	0.042~0.07	0.283
			14	10,700	880	0.052~0.087	0.178	9,100	660	0.047~0.078	0.178	7,300	470	0.036~0.061	0.178
			16	9,900	790	0.045~0.075	0.119	8,400	590	0.04~0.067	0.119	6,800	430	0.031~0.052	0.119
			18	9,200	710	0.039~0.064	0.084	7,800	540	0.035~0.058	0.084	6,500	390	0.027~0.045	0.084
			20	8,700	650	0.033~0.055	0.061	7,300	490	0.03~0.05	0.061	6,100	360	0.023~0.039	0.061
			25	7,600	520	0.022~0.036	0.031	6,400	390	0.019~0.032	0.031	5,500	300	0.015~0.025	0.031
			30	6,800	430	0.014~0.023	0.018	5,700	320	0.012~0.02	0.018	5,000	250	0.01~0.016	0.018
			40	5,700	290	0.005~0.008	0.008	4,800	220	0.004~0.007	0.008	4,400	170	0.003~0.006	0.008
CBN Series	2030	3	8	13,200	1,470	0.103~0.172	1.978	10,900	1,080	0.093~0.155	1.978	8,000	700	0.072~0.12	1.978
			10	11,600	1,270	0.092~0.153	1.013	9,600	930	0.083~0.138	1.013	7,200	620	0.064~0.107	1.013
			12	10,500	1,110	0.081~0.136	0.586	8,700	830	0.073~0.122	0.586	6,700	560	0.057~0.095	0.586
			14	9,600	1,000	0.072~0.12	0.369	8,000	740	0.065~0.108	0.369	6,200	510	0.051~0.084	0.369
			16	8,900	900	0.064~0.107	0.247	7,400	670	0.058~0.096	0.247	5,900	470	0.045~0.075	0.247
			18	8,300	820	0.057~0.094	0.174	7,000	610	0.051~0.085	0.174	5,600	430	0.04~0.066	0.174
			20	7,800	750	0.05~0.083	0.127	6,600	560	0.045~0.075	0.127	5,300	400	0.035~0.058	0.127
			25	6,900	620	0.036~0.06	0.065	5,800	460	0.032~0.054	0.065	4,800	340	0.025~0.042	0.065
			30	6,200	520	0.026~0.043	0.038	5,200	390	0.023~0.039	0.038	4,500	290	0.018~0.03	0.038
			35	5,700	440	0.018~0.031	0.024	4,800	330	0.016~0.027	0.024	4,200	250	0.013~0.021	0.024
Square	2040	4	8	13,200	1,470	0.103~0.172	1.978	10,900	1,080	0.093~0.155	1.978	8,000	700	0.072~0.12	1.978
			10	11,600	1,270	0.092~0.153	1.013	9,600	930	0.083~0.138	1.013	7,200	620	0.064~0.107	1.013
			12	10,500	1,110	0.081~0.136	0.586	8,700	830	0.073~0.122	0.586	6,700	560	0.057~0.095	0.586
			14	9,600	1,000	0.072~0.12	0.369	8,000	740	0.065~0.108	0.369	6,200	510	0.051~0.084	0.369
			16	8,900	900	0.064~0.107	0.247	7,400	670	0.058~0.096	0.247	5,900	470	0.045~0.075	0.247
			18	8,300	820	0.057~0.094	0.174	7,000	610	0.051~0.085	0.174	5,600	430	0.04~0.066	0.174
			20	7,800	750	0.05~0.083	0.127	6,600	560	0.045~0.075	0.127	5,300	400	0.035~0.058	0.127
			25	6,900	620	0.036~0.06	0.065	5,800	460	0.032~0.054	0.065	4,800	340	0.025~0.042	0.065
			30	6,200	520	0.026~0.043	0.038	5,200	390	0.023~0.039	0.038	4,500	290	0.018~0.03	0.038
			35	5,700	440	0.018~0.031	0.024	4,800	330	0.016~0.027	0.024	4,200	250	0.013~0.021	0.024
Long Neck Square	2050	5	8	13,200	1,470	0.103~0.172	1.978	10,900	1,080	0.093~0.155	1.978	8,000	700	0.072~0.12	1.978
			10	11,600	1,270	0.092~0.153	1.013	9,600	930	0.083~0.138	1.013	7,200	620	0.064~0.107	1.013
			12	10,500	1,110	0.081~0.136	0.586	8,700	830	0.073~0.122	0.586	6,700	560	0.057~0.095	0.586
			14	9,600	1,000	0.072~0.12	0.369	8,000	740	0.065~0.108	0.369	6,200	510	0.051~0.084	0.369
			16	8,900	900	0.064~0.107	0.247	7,400	670	0.058~0.096	0.247	5,900	470	0.045~0.075	0.247
			18	8,300	820	0.057~0.094	0.174	7,000	610	0.051~0.085	0.174	5,600	430	0.04~0.066	0.174
			20	7,800	750	0.05~0.083	0.127	6,600	560	0.045~0.075	0.127	5,300	400	0.035~0.058	0.127
			25	6,900	620	0.036~0.06	0.065	5,800	460	0.032~0.054	0.065	4,800	340	0.025~0.042	0.065
			30	6,200	520	0.026~0.043	0.038	5,200	390	0.023~0.039	0.038	4,500	290	0.018~0.03	0.038
			35	5,700	440	0.018~0.031	0.024	4,800	330	0.016~0.027	0.024	4,200	250	0.013~0.021	0.024
Radius	2060	6	8	13,200	1,470	0.103~0.172	1.978	10,900	1,080	0.093~0.155	1.978	8,000	700	0.072~0.12	1.978
			10	11,600	1,270	0.092~0.153	1.013	9,600	930	0.083~0.138	1.013	7,200	620	0.064~0.107	1.013
			12	10,500	1,110	0.081~0.136	0.586	8,700	830	0.073~0.122	0.586	6,700	560	0.057~0.095	0.586
			14	9,600	1,000	0.072~0.12	0.369	8,000	740	0.065~0.108	0.369	6,200	510	0.051~0.084	0.369
			16	8,900	900	0.064~0.107	0.247	7,400	670	0.058~0.096	0.247	5,900	470	0.045~0.075	0.247
			18	8,300	820	0.057~0.094	0.174	7,000	610	0.051~0.085	0.174	5,600	430	0.04~0.066	0.174
			20	7,800	750	0.05~0.083	0.127	6,600	560	0.045~0.075	0.127	5,300	400	0.035~0.058	0.127
			25	6,900	620	0.036~0.06	0.065	5,800	460	0.032~0.054	0.065	4,800	340	0.025~0.042	0.065
			30	6,200	520	0.026~0.043	0.038	5,200	390	0.023~0.039	0.038	4,500	290	0.018~0.03	0.038
			35	5,700	440	0.018~0.031	0.024	4,800	330	0.016~0.027	0.024	4,200	250	0.013~0.021	0.024
Long Neck Radius	2070	7	8	13,200	1,470	0.103~0.172	1.978	10,900	1,080	0.093~0.155	1.978	8,000	700	0.072~0.12	1.978
			10	11,600	1,270	0.092~0.153	1.013	9,600	930	0.083~0.138	1.013	7,200	620	0.064~0.107	1.013
			12	10,500	1,110	0.081~0.136	0.586	8,700	830	0.073~0.122	0.586	6,700	560	0.057~0.095	0.586
			14	9,600	1,000	0.072~0.12	0.369	8,000	740	0.065~0.108	0.369	6,200	510	0.051~0.084	0.369
			16	8,900	900	0.064~0.107	0.247	7,400	670	0.058~0.096	0.247	5,900	470	0.045~0.075	0.247
			18	8,300	820	0.057~0.094	0.174	7,000	610	0.051~0.085	0.174	5,600	430	0.04~0.066	0.174
			20	7,800	750	0.05~0.083	0.127	6,600	560	0.045~0.075	0.127	5,300	400	0.035~0.058	0.127
			25	6,900	620	0.036~0.06	0.065	5,800	460	0.032~0.054	0.065	4,800	340	0.025~0.042	0.065
			30	6,200	520	0.026~0.043	0.038	5,200	390	0.023~0.039	0.038	4,500	290	0.018~0.03	0.038
			35	5,700	440	0.018~0.031	0.024	4,800	330	0.016~0.027	0.024	4,200	250	0.013~0.021	0.024
Taper Neck Radius	2080	8	8	13,200	1,470	0.103~0.172	1.978	10,900	1,080	0.093~0.155	1.978	8,000	700	0.072~0.12	1.978
			10	11,600	1,270	0.092~0.153	1.013	9,600	930	0.083~0.138	1.013	7,200	620	0.064~0.107	1.013
			12	10,500	1,110	0.081~0.136	0.586	8,700	830	0.073~0.122	0.586	6,700	560	0.057~0.095	0.586
			14	9,600	1,000	0.072~0.12	0.369	8,000	740	0.065~0.108	0.369	6,200	510	0.051~0.084	0.369
			16	8,900	900	0.064~0.107	0.247	7,400	670	0.058~0.096	0.247	5,900	470	0.045~0.075	0.247
			18	8,300	820	0.057~0.094	0.174	7,000	610	0.051~0.085	0.174	5,600	430	0.04~0.066	0.174
			20	7,800	750	0.05~0.083	0.127	6,600	560	0.045~0.075	0.127	5,300	400	0.035~0.058	0.127
			25	6,900	620	0.036~0.06	0.065	5,800	460	0.032~0.054	0.065	4,800	340	0.025~0.042	0.065
			30	6,200	520	0.026~0.043	0.038	5,200	390	0.023~0.039	0.038	4,500	290	0.018~0.03	0.038
			35	5,700	440	0.018~0.031	0.024	4,800	330	0.016~0.027	0.024	4,200	250	0.013~0.021	0.024
Ball / Long Shank Ball	2090	10	8	13,200	1,470	0.103~0.172	1.978	10,900	1,080	0.093~0.155	1.978	8,000	700	0.072~0.12	1.978
			10	11,600	1,270	0.092~0.153	1.013	9,600	930	0.083~0.138	1.013	7,200	620	0.064~0.107	1.013
			12	10,500	1,110	0.081~0.136	0.586	8,700	830	0.073~0.122	0.586	6,700	560	0.057~0.095	0.586
			14	9,600	1,000	0.072~0.12	0.369	8,000	740	0.065~0.108	0.369	6,200	510	0.051~0.084	0.369
			16	8,900	900	0.064~0.107	0.247	7,400	670	0.058~0.096	0.247	5,900	470	0.045~0.075	0.247
			18	8,300	820	0.057~0.094	0.174	7,000	610	0.051~0.085	0.174	5,600	430	0.04~0.066	0.174
			20	7,800	750	0.05~0.083	0.127	6,600	560	0.045~0.075	0.127	5,300	400	0.035~0.058	0.127
			25	6,900	620	0.036~0.06	0.065	5,800	460	0.032~0.054	0.065	4,800	340	0.025~0.042	0.065
			30	6,200	520	0.026~0.043	0.038	5,200	390	0					

Milling Conditions for HLS (2 Flutes)

WORK MATERIAL			HARDENED STEELS SKD / SKT (45~55HRC)				HARDENED STEELS SKD / SKH (55~60HRC)			
Model Number	Outside Diameter (mm)	Effective Length (mm)	Spindle Speed (min ⁻¹)	Feed Rate (mm/min)	a_p Axial Depth (mm)	a_e Radial Depth (mm)	Spindle Speed (min ⁻¹)	Feed Rate (mm/min)	a_p Axial Depth (mm)	a_e Radial Depth (mm)
2025	2.5	8	7,700	460	0.039~0.064	0.954	9,600	227	0.023~0.038	0.954
		10	6,900	400	0.034~0.057	0.488	9,600	116	0.02~0.034	0.488
		12	6,300	360	0.03~0.05	0.283	9,600	67	0.018~0.03	0.283
		14	5,800	320	0.026~0.043	0.178	9,600	42	0.015~0.026	0.178
		16	5,500	290	0.022~0.037	0.119	9,600	28	0.013~0.022	0.119
		18	5,200	270	0.019~0.032	0.084	9,600	20	0.011~0.019	0.084
		20	4,900	250	0.017~0.028	0.061	9,600	14	0.01~0.017	0.061
		25	4,400	210	0.011~0.018	0.031	—	—	—~—	0.031
		30	4,000	170	0.007~0.011	0.018	—	—	—~—	0.018
		40	3,500	120	0.002~0.004	0.008	—	—	—~—	0.008
		50	3,100	80	0.002~0.002	0.004	—	—	—~—	0.004
2030	3	8	6,400	480	0.052~0.086	1.978	8,000	435	0.031~0.052	1.978
		10	5,800	430	0.046~0.076	1.013	8,000	222	0.027~0.046	1.013
		12	5,300	380	0.041~0.068	0.586	8,000	128	0.024~0.041	0.586
		14	5,000	350	0.036~0.06	0.369	8,000	81	0.021~0.036	0.369
		16	4,700	320	0.032~0.053	0.247	8,000	54	0.019~0.032	0.247
		18	4,500	300	0.028~0.047	0.174	8,000	38	0.016~0.028	0.174
		20	4,300	280	0.025~0.042	0.127	8,000	27	0.015~0.025	0.127
		25	3,900	230	0.018~0.03	0.065	8,000	14	0.01~0.018	0.065
		30	3,600	200	0.013~0.022	0.038	8,000	10	0.007~0.013	0.038
		35	3,300	170	0.009~0.015	0.024	—	—	—~—	0.024
		40	3,100	150	0.006~0.011	0.016	—	—	—~—	0.016
		50	2,800	110	0.003~0.005	0.008	—	—	—~—	0.008
2040	4	12	4,100	410	0.056~0.093	1.852	6,000	388	0.033~0.056	1.852
		16	3,600	350	0.046~0.077	0.781	6,000	164	0.027~0.046	0.781
		20	3,200	300	0.038~0.064	0.4	6,000	84	0.022~0.038	0.4
		25	2,900	260	0.03~0.051	0.205	6,000	43	0.018~0.031	0.205
		30	2,600	230	0.024~0.04	0.119	6,000	24	0.014~0.024	0.119
		35	2,500	200	0.019~0.031	0.075	6,000	15	0.011~0.019	0.075
		40	2,300	180	0.015~0.025	0.05	6,000	10	0.009~0.015	0.05
		45	2,200	160	0.012~0.019	0.035	—	—	—~—	0.035
		50	2,100	140	0.009~0.015	0.026	—	—	—~—	0.026
		60	1,900	110	0.006~0.009	0.015	—	—	—~—	0.015
2050	5	16	2,800	360	0.064~0.106	1.907	4,800	457	0.038~0.064	1.907
		20	2,500	310	0.061~0.101	0.977	4,800	234	0.036~0.061	0.977
		25	2,200	270	0.055~0.091	0.5	4,800	120	0.033~0.055	0.5
		30	2,000	230	0.047~0.078	0.289	4,800	69	0.028~0.047	0.289
		35	1,900	210	0.038~0.064	0.182	4,800	43	0.022~0.038	0.182
		40	1,700	180	0.03~0.05	0.122	4,800	29	0.018~0.03	0.122
		50	1,500	150	0.016~0.026	0.063	4,800	15	0.009~0.016	0.063
60	1,400	120	0.007~0.011	0.035	4,800	10	0.004~0.007	0.035		
2060	6	20	2,100	330	0.063~0.105	2.025	4,000	607	0.037~0.063	2.025
		30	1,600	240	0.055~0.091	0.6	4,000	180	0.033~0.055	0.6
		40	1,300	170	0.041~0.069	0.253	4,000	75	0.024~0.041	0.253
		50	1,200	160	0.027~0.045	0.13	4,000	38	0.016~0.027	0.13
		60	1,000	120	0.016~0.026	0.075	4,000	22	0.009~0.016	0.075

Side Milling
 a_p : Axial Depth (mm)
 a_e : Radial Depth (mm)

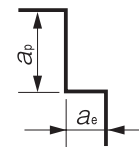

Slotting
 a_p : Axial Depth (mm)
 D : Outside Diameter (mm)

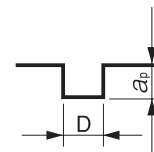

Note:

- Recommend using a non-contact measuring device to avoid damaging the precision tip point.
- Decrease both spindle speed and feed rate proportionally when the milling parameters exceed the machine's maximum spindle speed.
- Every coolant offers stable milling.
- Recommend oil coolant for Stainless Steels and Heat Resistant Alloys.
- Recommend wet coolant for Copper.

UDC Series

CBN Series

Square

Long Neck Square

Radius

Long Neck Radius

Taper Neck Radius

Ball / Long Shank Ball

Long Neck Ball

Taper Neck Ball

Taper

Spiral V Cutter

Drill

EURO Series

Technical Data



Size $\phi 0.1 \sim \phi 6$

C-CER



Additional 10 models

Material Applications (☆ Highly Recommended ○ Recommended ○ Suggested)

Work Material															
Carbon Steels S45C S55C	Alloy Steels SK / SCM SUS	Prehardened Steels NAK HPM	Hardened Steels			Cast Iron	Aluminum Alloys	Graphite	Copper	Plastics	Glass Filled Plastics	Titanium Alloys	Heat Resistant Alloys	Cemented Carbide	Hard Brittle (Non-Metallic) Materials
			~55HRC	~60HRC	~70HRC										
○	○	○	○			○			○			○	○		

Features

Recommend deep rib milling using an under cut design.

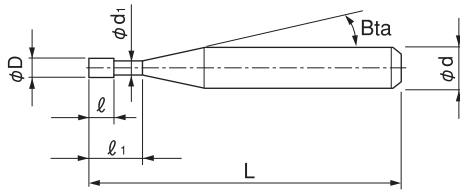

The shank taper angle shown is not an exact value and to avoid contact with the work piece, we recommend the user controls the precise value of this angle. Shank taper angle should not make contact with the work piece.

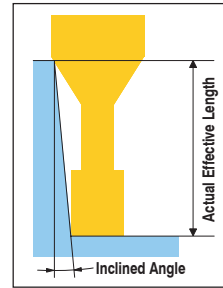

Total 148 models

Unit (mm)

Model Number	Outside Diameter ϕD	Effective Length ℓ_1	Length of Cut ℓ	Neck Diameter ϕd_1	Shank Taper Angle Bta	Overall Length L	Shank Diameter ϕd	Price ¥	Effective Length by Inclined Angles				
									30°	1°	1° 30'	2°	3°
※ C-CER 2001-0.3	0.1	0.3	0.1	0.088	11°	45	4	11,160	0.32	0.35	0.38	0.40	0.47
※ C-CER 2001-0.5		0.5				45	4	12,240	0.54	0.58	0.61	0.65	0.75
※ C-CER 2001-0.75		0.75				45	4	13,560	0.80	0.85	0.91	0.97	1.11
※ C-CER 2001-1		1				45	4	15,240	1.07	1.13	1.20	1.28	1.47
※ C-CER 20015-0.5	0.15	0.5	0.15	0.128	11°	45	4	11,400	0.57	0.61	0.65	0.69	0.79
※ C-CER 20015-0.75		0.75				45	4	12,600	0.84	0.88	0.94	1.00	1.15
※ C-CER 20015-1		1				45	4	12,600	1.10	1.16	1.23	1.31	1.51
※ C-CER 2002-0.5		0.5				45	4	8,640	0.65	0.70	0.74	0.78	0.85
※ C-CER 2002-1	0.2	1	0.3	0.18	16°	45	4	9,360	1.18	1.25	1.31	1.36	1.45
※ C-CER 2002-1.5		1.5				45	4	11,280	1.67	1.76	1.84	1.90	2.01
※ C-CER 2002-2		2				45	4	12,480	2.20	2.30	2.39	2.48	2.69
※ C-CER 2002-3		3				45	4	12,840	3.25	3.37	3.50	3.63	3.93
※ C-CER 2003-1	0.3	1	0.4	0.28	16°	45	4	7,560	1.22	1.30	1.37	1.43	1.55
※ C-CER 2003-1.5		1.5				45	4	7,560	1.71	1.82	1.90	1.98	2.15
※ C-CER 2003-2		2				45	4	9,360	2.24	2.36	2.46	2.55	2.70
※ C-CER 2003-3		3				45	4	9,720	3.30	3.45	3.56	3.66	3.83

※Additional model

Next Page ➔

Unit (mm)

Model Number	Outside Diameter ϕD	Effective Length l_1	Length of Cut l	Neck Diameter ϕd_1	Shank Taper Angle Bta	Overall Length L	Shank Diameter ϕd	Price ¥	Effective Length by Inclined Angles				
									30'	1°	1° 30'	2°	3°
C-CER 2004-2	0.4	2	0.6	0.38	16°	45	4	6,700	2.31	2.47	2.60	2.71	2.91
C-CER 2004-3		3				45	4	5,520	3.38	3.57	3.72	3.85	4.07
C-CER 2004-4		4				45	4	5,520	4.44	4.65	4.82	4.96	5.21
C-CER 2004-5		5				45	4	5,520	5.49	5.73	5.91	6.06	6.33
C-CER 2005-2	0.5	2	0.7	0.48	16°	45	4	3,960	2.37	2.56	2.71	2.85	3.09
C-CER 2005-4		4				45	4	3,960	4.52	4.77	4.97	5.14	5.44
C-CER 2005-6		6				45	4	3,960	6.64	6.94	7.17	7.37	7.71
C-CER 2005-8		8				45	4	6,600	8.74	9.07	9.33	9.56	9.93
C-CER 2006-2	0.6	2	0.9	0.58	16°	45	4	4,200	2.35	2.59	2.78	2.94	3.23
C-CER 2006-4		4				45	4	4,200	4.54	4.84	5.08	5.28	5.68
C-CER 2006-6		6				45	4	4,200	6.68	7.03	7.30	7.56	8.13
C-CER 2006-8		8				45	4	6,840	8.80	9.19	9.51	9.84	10.58
C-CER 2006-10	10	45	4	7,920	10.90	11.33	11.71	12.11	13.02				
C-CER 2007-2	0.7	2	1	0.68	16°	45	4	4,800	2.35	2.59	2.78	2.94	3.23
C-CER 2007-3		3				45	4	4,800	3.46	3.73	3.94	4.13	4.46
C-CER 2007-4		4				45	4	4,800	4.54	4.84	5.08	5.28	5.68
C-CER 2007-6		6				45	4	4,800	6.68	7.03	7.30	7.56	8.13
C-CER 2007-8		8				45	4	7,000	8.80	9.19	9.51	9.84	10.58
C-CER 2007-10		10				50	4	8,000	10.90	11.33	11.71	12.11	13.02
C-CER 2008-4	0.8	4	1.2	0.78	16°	45	4	4,680	4.54	4.84	5.08	5.28	5.68
C-CER 2008-6		6				45	4	4,680	6.68	7.03	7.30	7.56	8.13
C-CER 2008-8		8				45	4	4,680	8.80	9.19	9.51	9.84	10.58
C-CER 2008-10		10				50	4	6,840	10.90	11.33	11.71	12.11	13.02
C-CER 2008-12		12				50	4	7,800	12.99	13.45	13.91	14.39	15.47
C-CER 2009-4		0.9				4	1.3	0.88	16°	45	4	5,000	4.54
C-CER 2009-6	6		45	4	5,400	6.68				7.03	7.30	7.56	8.13
C-CER 2009-8	8		45	4	5,400	8.80				9.19	9.51	9.84	10.58
C-CER 2009-10	10		45	4	5,400	10.90				11.33	11.71	12.11	13.02
C-CER 2009-15	15		50	4	8,000	16.11				16.65	17.21	17.81	19.14
C-CER 2010-4	1		4	1.5	0.95	16°				45	4	4,200	4.66
C-CER 2010-6		6	45				4	4,200	6.78	7.10	7.36	7.62	8.19
C-CER 2010-8		8	45				4	4,200	8.88	9.25	9.56	9.90	10.64
C-CER 2010-10		10	45				4	4,200	10.97	11.38	11.76	12.17	13.09
C-CER 2010-12		12	45				4	4,200	13.06	13.51	13.97	14.45	15.53
C-CER 2010-16		16	50				4	6,840	17.20	17.77	18.37	19.01	20.43
C-CER 2010-20	20	55	4	6,840	21.34	22.03	22.77	23.56	25.32				
C-CER 2012-6	1.2	6	1.8	1.14	11°	45	4	4,440	6.29	6.61	6.95	7.34	8.25
C-CER 2012-8		8				45	4	4,440	8.39	8.80	9.26	9.78	10.99
C-CER 2012-10		10				45	4	4,440	10.48	11.00	11.58	12.21	13.72
C-CER 2012-12		12				45	4	4,440	12.58	13.20	13.89	14.65	16.46
C-CER 2012-16		16				50	4	7,080	16.76	17.59	18.51	19.53	21.94
C-CER 2014-6		1.4				6	2.1	1.34	11°	45	4	4,560	6.29
C-CER 2014-8	8		45	4	4,560	8.39				8.80	9.26	9.78	10.99
C-CER 2014-10	10		45	4	4,560	10.48				11.00	11.58	12.21	13.72
C-CER 2014-12	12		45	4	4,560	12.58				13.20	13.89	14.65	16.46
C-CER 2014-14	14		45	4	4,560	14.67				15.40	16.20	17.09	19.20
C-CER 2014-16	16		50	4	5,280	16.76				17.59	18.51	19.53	21.94
C-CER 2014-22	22		55	4	7,080	23.05				24.19	25.44	26.84	No interference

UDC Series

CBN Series

Square
Long Neck Square

Radius

Radius
Long Neck Radius
Taper Neck RadiusBall / Long Shank Ball
Long Neck Ball

Taper Neck Ball

Taper

Spiral V Cutter

Drill

EURO Series

Technical Data

Model Number	Outside Diameter ϕD	Effective Length ℓ_1	Length of Cut ℓ	Neck Diameter ϕd_1	Shank Taper Angle Bta	Overall Length L	Shank Diameter ϕd	Price ¥	Effective Length by Inclined Angles				
									30'	1°	1° 30'	2°	3°
C-CER 2015-6	1.5	6	2.3	1.44	11°	45	4	4,440	6.29	6.61	6.95	7.34	8.25
C-CER 2015-8		8				45	4	4,440	8.39	8.80	9.26	9.78	10.99
C-CER 2015-10		10				45	4	4,440	10.48	11.00	11.58	12.21	13.72
C-CER 2015-12		12				45	4	4,440	12.58	13.20	13.89	14.65	16.46
C-CER 2015-14		14				50	4	4,560	14.67	15.40	16.20	17.09	19.20
C-CER 2015-16		16				50	4	4,560	16.76	17.59	18.51	19.53	21.94
C-CER 2015-18		18				55	4	4,560	18.86	19.79	20.82	21.97	No Interference
C-CER 2015-20		20				55	4	4,560	20.95	21.99	23.13	24.40	No Interference
C-CER 2016-6		1.6				6	2.4	1.51	11°	45	4	4,560	6.35
C-CER 2016-8	8		45	4	4,560	8.44				8.86	9.32	9.84	11.06
C-CER 2016-10	10		45	4	4,560	10.54				11.06	11.64	12.28	13.79
C-CER 2016-12	12		45	4	4,560	12.63				13.26	13.95	14.71	16.53
C-CER 2016-14	14		50	4	4,560	14.72				15.45	16.26	17.15	19.27
C-CER 2016-16	16		50	4	4,560	16.82				17.65	18.57	19.59	22.01
C-CER 2016-18	18		55	4	4,560	18.91				19.85	20.88	22.03	No Interference
C-CER 2016-20	20		55	4	4,560	21.01				22.05	23.19	24.47	No Interference
C-CER 2016-26	26		60	4	7,200	27.29				28.64	30.13	31.78	No Interference
C-CER 2018-6	1.8	6	2.7	1.71	11°	45	4	4,560	6.35	6.66	7.01	7.40	8.32
C-CER 2018-8		8				45	4	4,560	8.44	8.86	9.32	9.84	11.06
C-CER 2018-10		10				45	4	4,560	10.54	11.06	11.64	12.28	13.79
C-CER 2018-12		12				45	4	4,560	12.63	13.26	13.95	14.71	16.53
C-CER 2018-14		14				50	4	4,560	14.72	15.45	16.26	17.15	19.27
C-CER 2018-16		16				50	4	4,560	16.82	17.65	18.57	19.59	No Interference
C-CER 2018-18		18				55	4	4,560	18.91	19.85	20.88	22.03	No Interference
C-CER 2018-20		20				55	4	4,560	21.01	22.05	23.19	24.47	No Interference
C-CER 2018-25		25				60	4	6,240	26.24	27.54	28.97	30.56	No Interference
C-CER 2020-6	2	6	3	1.91	11°	45	4	4,440	6.35	6.66	7.01	7.40	8.32
C-CER 2020-8		8				45	4	4,440	8.44	8.86	9.32	9.84	11.06
C-CER 2020-10		10				45	4	4,440	10.54	11.06	11.64	12.28	13.79
C-CER 2020-12		12				45	4	4,440	12.63	13.26	13.95	14.71	16.53
C-CER 2020-14		14				50	4	4,440	14.72	15.45	16.26	17.15	19.27
C-CER 2020-16		16				50	4	4,440	16.82	17.65	18.57	19.59	No Interference
C-CER 2020-18		18				55	4	4,440	18.91	19.85	20.88	22.03	No Interference
C-CER 2020-20		20				55	4	4,440	21.01	22.05	23.19	24.47	No Interference
C-CER 2020-25		25				60	4	4,440	26.24	27.54	28.97	No Interference	No Interference
C-CER 2020-30	30	70	4	5,520	31.48	33.03	34.75	No Interference	No Interference				
C-CER 2025-8	2.5	8	3.7	2.41	11°	45	4	4,680	8.44	8.86	9.32	9.84	11.06
C-CER 2025-10		10				45	4	4,680	10.54	11.06	11.64	12.28	13.79
C-CER 2025-12		12				45	4	4,680	12.63	13.26	13.95	14.71	No Interference
C-CER 2025-14		14				50	4	4,680	14.72	15.45	16.26	17.15	No Interference
C-CER 2025-16		16				50	4	4,680	16.82	17.65	18.57	19.59	No Interference
C-CER 2025-18		18				55	4	4,680	18.91	19.85	20.88	No Interference	No Interference
C-CER 2025-20		20				55	4	4,680	21.01	22.05	23.19	No Interference	No Interference
C-CER 2025-25		25				60	4	5,040	26.24	27.54	28.97	No Interference	No Interference
C-CER 2025-30		30				70	4	5,040	31.48	33.03	No Interference	No Interference	No Interference

UDC Series

CBN Series

Square
Long Neck Square

Radius

Radius
Long Neck Radius
Taper Neck Radius

Ball / Long Shank Ball
Long Neck Ball

Taper Neck Ball

Taper

Spiral V Cutter

Drill

EURO Series

Technical Data

Unit (mm)

Model Number	Outside Diameter ϕD	Effective Length l_1	Length of Cut l	Neck Diameter ϕd_1	Shank Taper Angle Bta	Overall Length L	Shank Diameter ϕd	Price ¥	Effective Length by Inclined Angles								
									30'	1°	1° 30'	2°	3°				
C-CER 2030-8	3	8	4.5	2.92	11°	45	6	6,000	8.44	8.86	9.32	9.83	11.05				
C-CER 2030-10		10				45	6	6,000	10.53	11.05	11.63	12.27	13.79				
C-CER 2030-12		12				50	6	6,000	12.62	13.25	13.94	14.71	16.53				
C-CER 2030-14		14				50	6	6,000	14.72	15.45	16.25	17.15	19.26				
C-CER 2030-16		16				60	6	6,000	16.81	17.65	18.56	19.58	22.00				
C-CER 2030-18		18				60	6	6,000	18.91	19.84	20.88	22.02	24.74				
C-CER 2030-20		20				60	6	6,000	21.00	22.04	23.19	24.46	27.48				
C-CER 2030-25		25				70	6	6,000	26.24	27.53	28.97	30.55	No Interference				
C-CER 2030-30		30				80	6	7,200	31.47	33.03	34.74	36.65	No Interference				
C-CER 2030-35		35				80	6	7,440	36.71	38.52	40.52	42.74	No Interference				
C-CER 2030-40		40				90	6	7,440	41.94	44.01	46.30	No Interference	No Interference				
C-CER 2035-12	3.5	12	5	3.37	11°	50	6	8,400	12.76	13.39	14.09	14.86	16.70				
C-CER 2035-15		15				60	6	8,400	15.90	16.69	17.56	18.52	20.81				
C-CER 2035-16		16				60	6	8,400	16.95	17.79	18.71	19.74	22.18				
C-CER 2035-20		20				60	6	8,400	21.14	22.18	23.34	24.62	No Interference				
C-CER 2035-25		25				70	6	8,400	26.37	27.67	29.11	30.71	No Interference				
C-CER 2035-30		30				70	6	8,400	31.61	33.17	34.89	No Interference	No Interference				
C-CER 2035-35		35				80	6	8,400	36.84	38.66	40.67	No Interference	No Interference				
C-CER 2040-12		4				12	6	3.82	11°	50	6	6,960	12.89	13.53	14.24	15.02	16.88
C-CER 2040-16						16				60	6	6,960	17.08	17.93	18.86	19.90	No Interference
C-CER 2040-20						20				60	6	6,960	21.27	22.32	23.48	24.77	No Interference
C-CER 2040-25						25				70	6	6,960	26.51	27.82	29.26	No Interference	No Interference
C-CER 2040-30	30		70	6	6,960	31.74				33.31	35.04	No Interference	No Interference				
C-CER 2040-35	35		80	6	6,960	36.98				38.80	No Interference	No Interference	No Interference				
C-CER 2040-40	40		90	6	8,760	42.21				44.30	No Interference	No Interference	No Interference				
C-CER 2040-45	45		90	6	10,440	47.45				49.79	No Interference	No Interference	No Interference				
C-CER 2040-50	50		100	6	12,960	52.68				55.28	No Interference	No Interference	No Interference				
C-CER 2050-16	5		16	7.5	4.82	11°				60	6	8,760	17.08	17.93	18.86	No Interference	No Interference
C-CER 2050-20			20							60	6	8,760	21.27	22.32	No Interference	No Interference	No Interference
C-CER 2050-25		25	60				6	8,760	26.51	27.82	No Interference	No Interference	No Interference				
C-CER 2050-30		30	80				6	8,760	31.74	No Interference	No Interference	No Interference	No Interference				
C-CER 2050-35		35	80				6	8,760	36.98	No Interference	No Interference	No Interference	No Interference				
C-CER 2050-40		40	80				6	8,760	42.21	No Interference	No Interference	No Interference	No Interference				
C-CER 2050-50		50	110				6	13,800	52.68	No Interference	No Interference	No Interference	No Interference				
C-CER 2060-20		6	20				9	5.82	—	80	6	9,000	No Interference	No Interference	No Interference	No Interference	No Interference
C-CER 2060-30	30		80	6	9,240	No Interference				No Interference	No Interference	No Interference	No Interference				
C-CER 2060-40	40		100	6	10,920	No Interference				No Interference	No Interference	No Interference	No Interference				
C-CER 2060-50	50		120	6	13,800	No Interference				No Interference	No Interference	No Interference	No Interference				
C-CER 2060-60	60		120	6	16,440	No Interference				No Interference	No Interference	No Interference	No Interference				

UDC Series

CBN Series

Square

Long Neck Square

Radius

Long Neck Radius

Taper Neck Radius

Ball / Long Shank Ball

Long Neck Ball

Taper Neck Ball

Taper

Spiral V Cutter

Drill

EURO Series

Technical Data

Milling Conditions for C-CER

WORK MATERIAL			COPPER OFC / TPC			CARBON STEELS S45C / S50C (~225HB)			ALLOY STEELS SK / SCM / SUS (225~325HB)			PREHARDENED STEELS HARDENED STEELS NAK / SKD (30~45HRC)			HARDENED STEELS SKD / SKT (45~50HRC)			
Model Number	Outside Diameter (mm)	Effective Length (mm)	Spindle Speed (min ⁻¹)	Feed Rate (mm/min)	a _p Axial Depth (mm)	Spindle Speed (min ⁻¹)	Feed Rate (mm/min)	a _p Axial Depth (mm)	Spindle Speed (min ⁻¹)	Feed Rate (mm/min)	a _p Axial Depth (mm)	Spindle Speed (min ⁻¹)	Feed Rate (mm/min)	a _p Axial Depth (mm)	Spindle Speed (min ⁻¹)	Feed Rate (mm/min)	a _p Axial Depth (mm)	
UDC Series	2001	0.1	0.3	30,000	30	0.003~0.006	30,000	30	0.003~0.005	30,000	15	0.002~0.005	30,000	16	0.001~0.004	—	—	—
			0.5	28,000	28	0.002~0.006	28,000	28	0.002~0.005	28,000	14	0.002~0.004	28,000	14	0.001~0.003	—	—	—
			0.75	25,500	26	0.002~0.005	25,500	26	0.002~0.004	25,500	13	0.002~0.003	25,500	12	0.001~0.002	—	—	—
			1	23,000	5	0.002~0.004	23,000	5	0.001~0.002	23,000	5	0.001~0.002	23,000	5	0.001	—	—	—
CBN Series	2001	0.1	0.5	30,000	90	0.004~0.008	30,000	90	0.004~0.007	30,000	80	0.003~0.006	30,000	70	0.003~0.005	30,000	50	0.003~0.004
			0.75	28,700	90	0.003~0.008	28,700	90	0.003~0.007	28,700	80	0.002~0.006	28,700	70	0.002~0.005	28,700	50	0.002~0.004
			1	27,300	80	0.002~0.006	27,300	80	0.002~0.006	27,300	70	0.001~0.005	27,300	60	0.001~0.004	27,300	40	0.001~0.003
Square	20015	0.15	0.5	43,000	130	0.005~0.011	43,000	130	0.005~0.009	41,000	110	0.004~0.008	39,000	90	0.003~0.006	39,000	40	0.002~0.004
			1	34,000	100	0.005~0.01	34,000	100	0.005~0.008	32,000	80	0.004~0.007	30,000	70	0.003~0.006	30,000	30	0.002~0.004
			1.5	27,000	80	0.002~0.005	27,000	80	0.002~0.004	24,000	60	0.002~0.003	23,000	50	0.001~0.003	23,000	20	0.001~0.002
Long Neck Square	2002	0.2	2	21,900	20	0.002~0.004	21,900	20	0.001~0.002	21,900	15	0.001~0.002	21,900	10	0.001~0.002	21,900	10	0.001
			3	16,500	10	0.001~0.003	16,500	10	0.001~0.002	16,500	8	0.001~0.002	16,500	5	0.001~0.002	16,500	5	0.001
			0.5	49,000	520	0.007~0.016	49,000	440	0.007~0.013	49,000	390	0.007~0.011	49,000	350	0.005~0.009	38,000	230	0.003~0.006
Radius	2003	0.3	1.5	43,000	425	0.005~0.012	43,000	360	0.005~0.01	43,000	320	0.005~0.008	43,000	285	0.004~0.007	37,500	210	0.002~0.004
			2	37,000	330	0.003~0.007	37,000	280	0.003~0.006	37,000	250	0.003~0.005	37,000	220	0.002~0.004	37,000	190	0.001~0.003
			3	31,000	280	0.002~0.004	31,000	240	0.002~0.003	31,000	210	0.001~0.003	31,000	190	0.001~0.002	31,000	160	0.001~0.002
			2	47,000	720	0.01~0.02	47,000	600	0.01~0.017	47,000	560	0.009~0.015	42,000	410	0.007~0.012	30,000	250	0.005~0.008
Long Neck Radius	2004	0.4	3	47,000	630	0.005~0.01	47,000	530	0.005~0.008	47,000	470	0.004~0.007	40,000	350	0.003~0.006	30,000	220	0.002~0.004
			4	39,000	520	0.002~0.005	39,000	440	0.002~0.004	37,000	370	0.002~0.004	31,000	270	0.002~0.003	30,000	220	0.001~0.002
			5	38,000	440	0.002~0.005	38,000	370	0.002~0.004	32,000	280	0.002~0.003	29,000	220	0.001~0.003	28,000	180	0.001~0.002
			2	47,000	900	0.014~0.028	47,000	750	0.014~0.023	43,000	610	0.012~0.021	38,000	460	0.009~0.016	25,000	260	0.004~0.007
Taper Neck Radius	2005	0.5	4	43,000	750	0.008~0.017	43,000	630	0.008~0.014	40,000	520	0.007~0.013	28,000	320	0.006~0.01	24,000	230	0.002~0.004
			6	31,000	460	0.004~0.008	31,000	390	0.004~0.007	26,000	290	0.003~0.006	24,000	230	0.002~0.004	23,000	190	0.002~0.003
			8	25,000	360	0.002~0.004	25,000	300	0.002~0.003	21,000	220	0.001~0.003	19,000	180	0.001~0.002	18,000	140	0.001~0.002
			2	46,000	1,050	0.018~0.036	46,000	880	0.018~0.03	40,000	670	0.016~0.027	32,000	470	0.012~0.021	21,000	270	0.009~0.015
Ball / Long Shark Ball	2006	0.6	4	41,000	790	0.01~0.02	41,000	660	0.01~0.017	34,000	520	0.009~0.016	27,000	360	0.007~0.012	20,000	230	0.005~0.008
			6	31,000	600	0.005~0.011	31,000	500	0.005~0.009	26,000	370	0.005~0.008	21,000	260	0.003~0.006	20,000	210	0.002~0.004
			8	23,000	360	0.002~0.005	23,000	300	0.002~0.004	19,000	220	0.002~0.003	18,000	180	0.001~0.002	16,000	140	0.001~0.002
			10	21,000	330	0.002~0.005	21,000	280	0.002~0.004	17,000	200	0.002~0.003	16,000	160	0.001~0.002	15,000	130	0.001~0.002
			Technical Data															

Milling Conditions for C-CER

WORK MATERIAL			COPPER OFC / TPC			CARBON STEELS S45C / S50C (~225HB)			ALLOY STEELS SK / SCM / SUS (225~325HB)			PREHARDENED STEELS HARDENED STEELS NAK / SKD (30~45HRC)			HARDENED STEELS SKD / SKT (45~50HRC)		
Model Number	Outside Diameter (mm)	Effective Length (mm)	Spindle Speed (min ⁻¹)	Feed Rate (mm/min)	a _p Axial Depth (mm)	Spindle Speed (min ⁻¹)	Feed Rate (mm/min)	a _p Axial Depth (mm)	Spindle Speed (min ⁻¹)	Feed Rate (mm/min)	a _p Axial Depth (mm)	Spindle Speed (min ⁻¹)	Feed Rate (mm/min)	a _p Axial Depth (mm)	Spindle Speed (min ⁻¹)	Feed Rate (mm/min)	a _p Axial Depth (mm)
2007	0.7	2	40,000	1,050	0.026~0.053	40,000	880	0.026~0.044	34,000	670	0.023~0.039	27,000	480	0.018~0.03	18,000	270	0.013~0.022
		3	40,000	1,050	0.022~0.044	40,000	880	0.022~0.037	34,000	670	0.02~0.033	27,000	470	0.015~0.026	18,000	270	0.011~0.018
		4	35,000	810	0.012~0.024	35,000	680	0.012~0.02	29,000	510	0.01~0.018	23,000	350	0.008~0.014	17,000	230	0.006~0.01
		6	27,000	620	0.006~0.013	27,000	520	0.006~0.011	22,000	380	0.005~0.009	18,000	270	0.004~0.007	17,000	220	0.003~0.005
		8	22,000	460	0.005~0.011	22,000	390	0.005~0.009	18,000	290	0.005~0.008	17,000	240	0.003~0.006	16,000	190	0.002~0.004
		10	20,000	360	0.002~0.005	20,000	300	0.002~0.004	16,000	220	0.002~0.004	15,000	180	0.001~0.003	14,000	140	0.001~0.002
2008	0.8	4	35,000	1,050	0.027~0.054	35,000	880	0.027~0.045	30,000	670	0.024~0.04	24,000	470	0.019~0.031	16,000	270	0.013~0.022
		6	31,000	820	0.013~0.028	31,000	690	0.013~0.023	25,000	510	0.012~0.02	20,000	350	0.009~0.016	15,000	220	0.006~0.011
		8	23,000	630	0.007~0.014	23,000	530	0.007~0.012	19,000	390	0.006~0.011	15,000	270	0.005~0.008	15,000	220	0.003~0.006
		10	19,000	450	0.006~0.012	19,000	380	0.006~0.01	16,000	280	0.005~0.009	15,000	230	0.004~0.007	14,000	180	0.003~0.005
		12	17,000	360	0.003~0.006	17,000	300	0.003~0.005	14,000	220	0.002~0.004	13,000	180	0.002~0.003	12,000	140	0.001~0.002
2009	0.9	4	31,000	1,090	0.028~0.058	31,000	910	0.028~0.048	26,000	690	0.026~0.043	21,000	480	0.02~0.033	14,000	270	0.014~0.024
		6	27,000	840	0.014~0.029	27,000	700	0.014~0.024	22,000	510	0.013~0.022	18,000	360	0.01~0.017	13,000	230	0.007~0.012
		8	21,000	640	0.008~0.016	21,000	540	0.008~0.013	17,000	400	0.007~0.012	14,000	280	0.005~0.009	13,000	230	0.004~0.006
		10	17,000	460	0.006~0.013	17,000	390	0.006~0.011	14,000	290	0.006~0.01	13,000	230	0.004~0.007	12,000	190	0.003~0.005
		15	11,000	320	0.003~0.006	11,000	270	0.003~0.005	13,000	200	0.003~0.005	12,000	160	0.002~0.003	11,000	130	0.001~0.002
2010	1	4	28,000	1,120	0.03~0.06	28,000	940	0.03~0.05	23,000	710	0.027~0.045	19,000	490	0.021~0.035	12,700	280	0.015~0.025
		6	24,000	850	0.015~0.03	24,000	710	0.015~0.025	20,000	520	0.013~0.023	16,000	360	0.01~0.017	12,000	230	0.007~0.012
		8	24,000	850	0.015~0.03	24,000	710	0.015~0.025	20,000	520	0.013~0.023	16,000	360	0.01~0.017	12,000	230	0.007~0.012
		10	19,000	640	0.008~0.017	19,000	540	0.008~0.014	15,000	400	0.007~0.012	12,000	280	0.005~0.009	12,000	230	0.004~0.007
		12	15,000	460	0.007~0.014	15,000	390	0.007~0.012	13,000	290	0.006~0.01	12,000	230	0.005~0.008	11,400	190	0.003~0.006
		16	12,000	360	0.003~0.007	12,000	300	0.003~0.006	10,500	220	0.003~0.005	9,700	180	0.002~0.004	9,100	140	0.001~0.003
		20	10,000	320	0.003~0.007	10,000	270	0.003~0.006	8,400	200	0.003~0.005	7,700	160	0.002~0.004	7,300	130	0.001~0.003
2012	1.2	6	23,000	1,050	0.036~0.072	23,000	880	0.036~0.06	20,000	670	0.032~0.054	16,000	470	0.025~0.042	10,000	260	0.018~0.03
		8	20,000	820	0.018~0.036	20,000	690	0.018~0.03	16,000	500	0.016~0.027	13,000	350	0.012~0.021	10,000	220	0.009~0.015
		10	15,000	630	0.01~0.019	15,000	530	0.01~0.016	13,000	390	0.009~0.015	10,600	270	0.007~0.011	10,000	220	0.005~0.008
		12	15,000	630	0.01~0.019	15,000	530	0.01~0.016	13,000	390	0.009~0.015	10,600	270	0.007~0.011	10,000	220	0.005~0.008
		16	11,000	320	0.004~0.008	11,000	270	0.004~0.007	9,000	200	0.003~0.006	9,000	160	0.003~0.005	8,400	130	0.002~0.003

UDC Series

CBN Series

Square

Long Neck Square

Radius

Long Neck Radius

Taper Neck Radius

Ball / Long Shank Ball

Long Neck Ball

Taper Neck Ball

Taper

Spiral V Cutter

Drill

EURO Series

Technical Data

Milling Conditions for C-CER

WORK MATERIAL			COPPER OFC / TPC			CARBON STEELS S45C / S50C (~225HB)			ALLOY STEELS SK / SCM / SUS (225~325HB)			PREHARDENED STEELS HARDENED STEELS NAK / SKD (30~45HRC)			HARDENED STEELS SKD / SKT (45~50HRC)			
Model Number	Outside Diameter (mm)	Effective Length (mm)	Spindle Speed (min ⁻¹)	Feed Rate (mm/min)	a _p Axial Depth (mm)	Spindle Speed (min ⁻¹)	Feed Rate (mm/min)	a _p Axial Depth (mm)	Spindle Speed (min ⁻¹)	Feed Rate (mm/min)	a _p Axial Depth (mm)	Spindle Speed (min ⁻¹)	Feed Rate (mm/min)	a _p Axial Depth (mm)	Spindle Speed (min ⁻¹)	Feed Rate (mm/min)	a _p Axial Depth (mm)	
UDC Series	2014	1.4	6	20,000	1,000	0.042~0.084	20,000	840	0.042~0.07	17,000	640	0.038~0.063	13,000	440	0.029~0.049	9,000	250	0.021~0.035
			8	17,000	790	0.021~0.042	17,000	660	0.021~0.035	14,000	480	0.019~0.032	11,500	330	0.015~0.025	8,600	210	0.01~0.017
			10	17,000	790	0.021~0.042	17,000	660	0.021~0.035	14,000	480	0.019~0.032	11,500	330	0.015~0.025	8,600	210	0.01~0.017
			12	13,000	620	0.011~0.023	13,000	520	0.011~0.019	11,000	380	0.01~0.017	9,000	270	0.008~0.013	8,600	220	0.005~0.009
			14	13,000	620	0.011~0.023	13,000	520	0.011~0.019	11,000	380	0.01~0.017	9,000	270	0.008~0.013	8,600	220	0.005~0.009
			16	11,000	430	0.01~0.02	11,000	360	0.01~0.017	9,000	270	0.009~0.015	8,000	220	0.007~0.011	8,100	180	0.005~0.008
			22	10,000	310	0.005~0.01	10,000	260	0.005~0.008	8,000	190	0.004~0.007	7,000	150	0.003~0.005	7,200	120	0.002~0.004
CBN Series	2015	1.5	6	18,000	1,030	0.045~0.09	18,000	860	0.045~0.075	15,000	650	0.04~0.068	12,000	460	0.031~0.052	8,400	260	0.022~0.037
			8	16,000	810	0.023~0.046	16,000	680	0.023~0.038	13,000	500	0.02~0.034	10,000	340	0.016~0.026	8,000	220	0.011~0.019
			10	16,000	810	0.023~0.046	16,000	680	0.023~0.038	13,000	500	0.02~0.034	10,000	340	0.016~0.026	8,000	220	0.011~0.019
			12	16,000	810	0.023~0.046	16,000	680	0.023~0.038	13,000	500	0.02~0.034	10,000	340	0.016~0.026	8,000	220	0.011~0.019
			14	12,700	620	0.012~0.025	12,700	520	0.012~0.021	10,600	390	0.011~0.018	8,400	270	0.008~0.014	8,000	220	0.006~0.01
			16	10,300	450	0.01~0.022	10,300	380	0.01~0.018	8,600	280	0.009~0.016	8,000	230	0.007~0.012	7,600	180	0.005~0.009
			18	10,300	450	0.01~0.022	10,300	380	0.01~0.018	8,600	280	0.009~0.016	8,000	230	0.007~0.012	7,600	180	0.005~0.009
			20	9,000	320	0.005~0.011	9,000	270	0.005~0.009	7,000	200	0.004~0.008	7,200	160	0.003~0.006	6,700	130	0.002~0.004
Square	2016	1.6	6	17,000	1,050	0.048~0.096	17,000	880	0.048~0.08	14,000	670	0.043~0.072	11,900	470	0.033~0.056	7,900	260	0.024~0.04
			8	17,000	1,050	0.048~0.096	17,000	880	0.048~0.08	14,000	670	0.043~0.072	11,900	470	0.033~0.056	7,900	260	0.024~0.04
			10	15,000	820	0.024~0.048	15,000	690	0.024~0.04	12,700	500	0.022~0.036	10,100	350	0.017~0.028	7,500	220	0.012~0.02
			12	15,000	820	0.024~0.048	15,000	690	0.024~0.04	12,700	500	0.022~0.036	10,100	350	0.017~0.028	7,500	220	0.012~0.02
			14	11,900	630	0.013~0.026	11,900	530	0.013~0.022	9,900	390	0.012~0.02	7,900	270	0.009~0.015	7,500	220	0.006~0.011
			16	11,900	630	0.013~0.026	11,900	530	0.013~0.022	9,900	390	0.012~0.02	7,900	270	0.009~0.015	7,500	220	0.006~0.011
			18	9,700	460	0.011~0.023	9,700	390	0.011~0.019	8,100	290	0.01~0.017	7,500	230	0.008~0.013	7,100	190	0.005~0.009
			20	9,000	450	0.011~0.023	9,000	380	0.011~0.019	8,100	280	0.01~0.017	7,500	230	0.008~0.013	7,100	180	0.005~0.009
			26	8,000	280	0.005~0.011	8,000	240	0.005~0.009	7,300	180	0.005~0.008	6,700	140	0.004~0.006	6,300	120	0.002~0.004
			Long Neck Square	2018	1.8	6	15,000	1,030	0.051~0.102	15,000	860	0.051~0.085	13,200	650	0.045~0.076	10,600	460	0.035~0.059
8	15,000	1,030				0.051~0.102	15,000	860	0.051~0.085	13,200	650	0.045~0.076	10,600	460	0.035~0.059	7,000	260	0.025~0.042
10	13,700	810				0.027~0.055	13,700	680	0.027~0.046	11,400	500	0.024~0.041	9,000	340	0.019~0.032	6,700	220	0.013~0.023
12	13,700	810				0.027~0.055	13,700	680	0.027~0.046	11,400	500	0.024~0.041	9,000	340	0.019~0.032	6,700	220	0.013~0.023
14	13,700	810				0.027~0.055	13,700	680	0.027~0.046	11,400	500	0.024~0.041	9,000	340	0.019~0.032	6,700	220	0.013~0.023
16	10,600	620				0.015~0.03	10,600	520	0.015~0.025	8,800	380	0.013~0.022	7,000	270	0.01~0.017	6,700	220	0.007~0.012
18	10,600	620				0.015~0.03	10,600	520	0.015~0.025	8,800	380	0.013~0.022	7,000	270	0.01~0.017	6,700	220	0.007~0.012
20	8,600	450				0.012~0.024	8,600	380	0.012~0.02	7,200	280	0.01~0.018	6,700	230	0.008~0.014	6,300	180	0.006~0.01
25	7,700	310				0.006~0.012	7,700	260	0.006~0.01	6,500	200	0.005~0.009	6,000	160	0.004~0.007	5,600	130	0.003~0.005

Milling Conditions for C-CER

WORK MATERIAL			COPPER OFC / TPC				CARBON STEELS S45C / S50C (~225HB)				ALLOY STEELS SK / SCM / SUS (225~325HB)			PREHARDENED STEELS HARDENED STEELS NAK / SKD (30~45HRC)			HARDENED STEELS SKD / SKT (45~50HRC)		
Model Number	Outside Diameter (mm)	Effective Length (mm)	Spindle Speed (min ⁻¹)	Feed Rate (mm/min)	a _p Axial Depth (mm)	Spindle Speed (min ⁻¹)	Feed Rate (mm/min)	a _p Axial Depth (mm)	Spindle Speed (min ⁻¹)	Feed Rate (mm/min)	a _p Axial Depth (mm)	Spindle Speed (min ⁻¹)	Feed Rate (mm/min)	a _p Axial Depth (mm)	Spindle Speed (min ⁻¹)	Feed Rate (mm/min)	a _p Axial Depth (mm)		
2020	2	6	14,000	1,080	0.058~0.118	14,000	900	0.058~0.098	12,000	680	0.052~0.088	9,600	480	0.041~0.068	6,400	270	0.029~0.049		
		8	14,000	1,020	0.052~0.106	14,000	850	0.052~0.088	12,000	650	0.047~0.079	9,600	450	0.037~0.061	6,400	260	0.026~0.044		
		10	14,000	1,020	0.052~0.106	14,000	850	0.052~0.088	12,000	650	0.047~0.079	9,600	450	0.037~0.061	6,400	260	0.026~0.044		
		12	12,300	790	0.026~0.053	12,300	660	0.026~0.044	10,400	500	0.024~0.04	8,100	340	0.018~0.031	6,000	220	0.013~0.022		
		14	12,300	790	0.026~0.053	12,300	660	0.026~0.044	10,400	500	0.024~0.04	8,100	340	0.018~0.031	6,000	220	0.013~0.022		
		16	12,300	790	0.026~0.053	12,300	660	0.026~0.044	10,400	500	0.024~0.04	8,100	340	0.018~0.031	6,000	220	0.013~0.022		
		18	9,500	610	0.014~0.029	9,500	510	0.014~0.024	7,900	380	0.013~0.022	6,300	270	0.01~0.017	6,000	220	0.007~0.012		
		20	9,500	610	0.014~0.029	9,500	510	0.014~0.024	7,900	380	0.013~0.022	6,300	270	0.01~0.017	6,000	220	0.007~0.012		
		25	7,700	430	0.012~0.025	7,700	360	0.012~0.021	6,400	270	0.011~0.018	6,000	220	0.008~0.014	5,700	180	0.006~0.01		
		30	7,000	310	0.006~0.012	7,000	260	0.006~0.01	5,800	190	0.005~0.009	5,400	150	0.004~0.007	5,000	120	0.003~0.005		
2025	2.5	8	10,800	1,390	0.066~0.132	10,800	1,160	0.066~0.11	9,100	880	0.059~0.099	7,600	640	0.046~0.077	5,100	360	0.033~0.055		
		10	10,800	1,390	0.066~0.132	10,800	1,160	0.066~0.11	9,100	880	0.059~0.099	7,600	640	0.046~0.077	5,100	360	0.033~0.055		
		12	10,800	1,390	0.066~0.132	10,800	1,160	0.066~0.11	9,100	880	0.059~0.099	7,600	640	0.046~0.077	5,100	360	0.033~0.055		
		14	9,500	1,090	0.033~0.067	9,500	910	0.033~0.056	8,000	680	0.03~0.05	6,500	490	0.023~0.039	4,800	310	0.016~0.028		
		16	9,500	1,090	0.033~0.067	9,500	910	0.033~0.056	8,000	680	0.03~0.05	6,500	490	0.023~0.039	4,800	310	0.016~0.028		
		18	9,500	1,090	0.033~0.067	9,500	910	0.033~0.056	8,000	680	0.03~0.05	6,500	490	0.023~0.039	4,800	310	0.016~0.028		
		20	9,500	1,090	0.033~0.067	9,500	910	0.033~0.056	8,000	680	0.03~0.05	6,500	490	0.023~0.039	4,800	310	0.016~0.028		
		25	7,600	820	0.018~0.036	7,600	690	0.018~0.03	6,300	510	0.016~0.027	5,000	360	0.012~0.021	4,800	290	0.009~0.015		
		30	6,200	480	0.014~0.029	6,200	400	0.014~0.024	5,200	300	0.013~0.022	4,800	240	0.01~0.017	4,500	200	0.007~0.012		
2030	3	8	8,700	1,580	0.088~0.176	8,700	1,320	0.088~0.147	7,300	990	0.079~0.132	5,900	700	0.055~0.092	4,200	420	0.044~0.073		
		10	8,700	1,500	0.079~0.158	8,700	1,250	0.079~0.132	7,300	940	0.071~0.119	5,900	660	0.055~0.092	4,200	400	0.039~0.066		
		12	8,700	1,500	0.079~0.158	8,700	1,250	0.079~0.132	7,300	940	0.071~0.119	5,900	660	0.055~0.092	4,200	400	0.039~0.066		
		14	8,700	1,500	0.079~0.158	8,700	1,250	0.079~0.132	7,300	940	0.071~0.119	5,900	660	0.055~0.092	4,200	400	0.039~0.066		
		16	7,600	1,160	0.04~0.08	7,600	970	0.04~0.067	6,300	720	0.036~0.06	5,000	500	0.028~0.047	3,900	340	0.02~0.033		
		18	7,600	1,160	0.04~0.08	7,600	970	0.04~0.067	6,300	720	0.036~0.06	5,000	500	0.028~0.047	3,900	340	0.02~0.033		
		20	7,600	1,160	0.04~0.08	7,600	970	0.04~0.067	6,300	720	0.036~0.06	5,000	500	0.028~0.047	3,900	340	0.02~0.033		
		25	6,300	970	0.022~0.043	6,300	810	0.022~0.036	5,300	600	0.019~0.033	4,200	420	0.015~0.025	3,900	340	0.011~0.018		
		30	6,300	970	0.022~0.043	6,300	810	0.022~0.036	5,300	600	0.019~0.033	4,200	420	0.015~0.025	3,900	340	0.011~0.018		
		35	5,100	490	0.017~0.035	5,100	410	0.017~0.029	4,300	300	0.016~0.026	4,000	240	0.012~0.02	3,800	200	0.008~0.014		
		40	4,600	310	0.007~0.014	4,600	260	0.007~0.012	3,900	200	0.006~0.01	3,600	160	0.005~0.008	3,300	130	0.003~0.006		

UDC Series

CBN Series

Square

Long Neck Square

Radius

Long Neck Radius

Taper Neck Radius

Ball / Long Shank Ball

Long Neck Ball

Taper Neck Ball

Taper

Spiral V Cutter

Drill

EURO Series

Technical Data

Milling Conditions for C-CER

WORK MATERIAL			COPPER OFC / TPC			CARBON STEELS S45C / S50C (~225HB)			ALLOY STEELS SK / SCM / SUS (225~325HB)			PREHARDENED STEELS HARDENED STEELS NAK / SKD (30~45HRC)			HARDENED STEELS SKD / SKT (45~50HRC)			
Model Number	Outside Diameter (mm)	Effective Length (mm)	Spindle Speed (min ⁻¹)	Feed Rate (mm/min)	a _p Axial Depth (mm)	Spindle Speed (min ⁻¹)	Feed Rate (mm/min)	a _p Axial Depth (mm)	Spindle Speed (min ⁻¹)	Feed Rate (mm/min)	a _p Axial Depth (mm)	Spindle Speed (min ⁻¹)	Feed Rate (mm/min)	a _p Axial Depth (mm)	Spindle Speed (min ⁻¹)	Feed Rate (mm/min)	a _p Axial Depth (mm)	
UDC Series	2035	3.5	12	7,100	1,280	0.092~0.185	7,100	1,070	0.092~0.154	6,000	790	0.083~0.138	4,800	560	0.064~0.108	3,300	330	0.046~0.077
			15	7,100	1,280	0.092~0.185	7,100	1,070	0.092~0.154	6,000	790	0.083~0.138	4,800	560	0.064~0.108	3,300	330	0.046~0.077
			16	7,100	1,280	0.092~0.185	7,100	1,070	0.092~0.154	6,000	790	0.083~0.138	4,800	560	0.064~0.108	3,300	330	0.046~0.077
			20	6,200	990	0.043~0.086	6,200	830	0.043~0.072	5,100	610	0.039~0.065	4,000	420	0.03~0.05	3,100	280	0.021~0.036
			25	6,200	990	0.043~0.086	6,200	830	0.043~0.072	5,100	610	0.039~0.065	4,000	420	0.03~0.05	3,100	280	0.021~0.036
			30	5,000	800	0.025~0.05	5,000	670	0.025~0.042	4,200	500	0.023~0.038	3,300	340	0.018~0.03	3,100	280	0.012~0.021
			35	5,000	800	0.025~0.05	5,000	670	0.025~0.042	4,200	500	0.023~0.038	3,300	340	0.018~0.03	3,100	280	0.012~0.021
Radius	2040	4	12	6,000	1,170	0.1~0.202	6,000	980	0.1~0.168	5,000	720	0.09~0.151	3,900	500	0.07~0.117	2,700	290	0.05~0.084
			16	6,000	1,110	0.09~0.181	6,000	930	0.09~0.151	5,000	690	0.081~0.136	3,900	480	0.063~0.105	2,700	280	0.045~0.075
			20	6,000	1,110	0.09~0.181	6,000	930	0.09~0.151	5,000	690	0.081~0.136	3,900	480	0.063~0.105	2,700	280	0.045~0.075
			25	5,200	860	0.046~0.091	5,200	720	0.046~0.076	4,200	520	0.041~0.069	3,300	350	0.032~0.053	2,500	230	0.023~0.038
			30	5,200	860	0.046~0.091	5,200	720	0.046~0.076	4,200	520	0.041~0.069	3,300	350	0.032~0.053	2,500	230	0.023~0.038
			35	4,200	660	0.025~0.05	4,200	550	0.025~0.042	3,500	400	0.022~0.037	2,700	270	0.017~0.029	2,500	220	0.012~0.021
			40	4,200	660	0.025~0.05	4,200	550	0.025~0.042	3,500	400	0.022~0.037	2,700	270	0.017~0.029	2,500	220	0.012~0.021
			45	3,400	430	0.018~0.037	3,400	360	0.018~0.031	2,800	270	0.016~0.028	2,500	210	0.013~0.021	2,300	160	0.009~0.015
			50	3,400	380	0.018~0.037	3,400	320	0.018~0.031	2,800	240	0.016~0.028	2,500	190	0.013~0.021	2,300	140	0.009~0.015
Taper	2050	5	16	4,400	870	0.113~0.227	4,400	730	0.113~0.189	3,600	530	0.102~0.17	2,800	360	0.079~0.132	1,700	190	0.056~0.094
			20	4,400	870	0.113~0.227	4,400	730	0.113~0.189	3,600	530	0.102~0.17	2,800	360	0.079~0.132	1,700	190	0.056~0.094
			25	4,400	870	0.113~0.227	4,400	730	0.113~0.189	3,600	530	0.102~0.17	2,800	360	0.079~0.132	1,700	190	0.056~0.094
			30	3,800	630	0.057~0.115	3,800	530	0.057~0.096	3,000	380	0.051~0.086	2,200	240	0.04~0.067	1,600	150	0.028~0.048
			35	3,800	630	0.057~0.115	3,800	530	0.057~0.096	3,000	380	0.051~0.086	2,200	240	0.04~0.067	1,600	150	0.028~0.048
			40	3,800	630	0.057~0.115	3,800	530	0.057~0.096	3,000	380	0.051~0.086	2,200	240	0.022~0.036	1,600	150	0.028~0.048
			50	2,900	460	0.031~0.062	2,900	390	0.031~0.052	2,400	280	0.028~0.047	1,700	180	0.022~0.036	1,600	140	0.015~0.026
EURO Series	2060	6	20	3,300	670	0.113~0.227	3,300	560	0.113~0.189	2,700	400	0.102~0.17	2,000	260	0.079~0.132	1,100	130	0.056~0.094
			30	3,300	670	0.113~0.227	3,300	560	0.113~0.189	2,700	400	0.102~0.17	2,000	260	0.079~0.132	1,100	130	0.056~0.094
			40	2,800	480	0.057~0.115	2,800	400	0.057~0.096	2,200	270	0.051~0.086	1,500	170	0.04~0.067	1,000	100	0.028~0.048
			50	2,100	330	0.031~0.062	2,100	280	0.031~0.052	1,600	200	0.028~0.047	1,100	120	0.022~0.036	1,000	90	0.015~0.026
			60	2,100	330	0.031~0.062	2,100	280	0.031~0.052	1,600	200	0.028~0.047	1,100	120	0.022~0.036	1,000	90	0.015~0.026

Slotting

a_p : Axial Depth (mm)
D : Outside Diameter (mm)

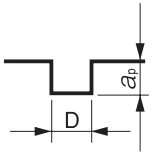

- Note:
- Decrease both spindle speed and feed rate proportionally when the milling parameters exceed the machine's maximum spindle speed.
 - Recommend water soluble or oil coolant.
 - Recommend oil coolant for Titanium Alloys and Heat Resistant Alloys.

UDC Series

CBN Series

Square
Long Neck Square

Radius
Long Neck Radius
Taper Neck Radius

Ball / Long Shank Ball
Long Neck Ball
Taper Neck Ball

Taper

Spiral V Cutter

Drill

EURO Series

Technical Data



Size $\phi 0.4 \sim \phi 6$

DCLS



Material Applications (☆ Highly Recommended ○ Recommended ○ Suggested)

Work Material															
Carbon Steels S45C S55C	Alloy Steels SK / SCM SUS	Prehardened Steels NAK HPM	Hardened Steels			Cast Iron	Aluminum Alloys	Graphite	Copper	Plastics	Glass Filled Plastics	Titanium Alloys	Heat Resistant Alloys	Cemented Carbide	Hard Brittle (Non-Metallic) Materials
			~55HRC	~60HRC	~70HRC										
							○	☆	○	○	◎				○

Features

2 Flute Diamond coated Long Neck Square End Mills for milling Graphite Electrodes.
 New diamond coating, with a highly adhesive base layer, offers excellent wear resistance and long tool life.

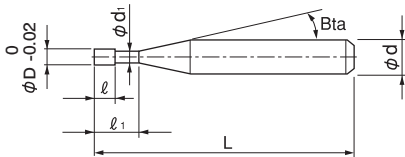

The shank taper angle shown is not an exact value and to avoid contact with the work piece, we recommend the user controls the precise value of this angle. Shank taper angle should not make contact with the work piece.

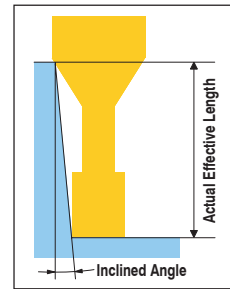

Neck diameter have been changed.
 Change Date: From Production in November, 2012

Total 45 models

Unit (mm)

Model Number	Outside Diameter ϕD	Effective Length ℓ_1	Length of Cut ℓ	Neck Diameter ϕd_1	Shank Taper Angle Bta	Overall Length L	Shank Diameter ϕd	Price ¥	Effective Length by Inclined Angles				
									30'	1°	1° 30'	2°	3°
DCLS 2004-020	0.4	2	0.8	0.37	16°	45	4	16,000	2.26	2.43	2.57	2.68	2.89
DCLS 2004-040		4							4.40	4.63	4.80	4.97	5.34
DCLS 2004-060		6							6.51	6.77	7.00	7.24	7.79
DCLS 2005-020	0.5	2	1	0.47	16°	45	4	16,000	2.32	2.52	2.68	2.82	3.07
DCLS 2005-040		4							4.48	4.74	4.95	5.13	5.51
DCLS 2005-060		6							6.60	6.91	7.15	7.40	7.96
DCLS 2006-020	0.6	2	1.2	0.57	16°	45	4	16,000	2.36	2.60	2.78	2.95	3.23
DCLS 2006-040		4							4.55	4.85	5.08	5.29	5.68
DCLS 2006-060		6							6.69	7.04	7.31	7.56	8.13
DCLS 2006-080		8				45	4	16,000	8.80	9.19	9.51	9.84	10.58
DCLS 2006-100		10				45	4	16,000	10.90	11.33	11.71	12.12	13.03

Unit (mm)

Model Number	Outside Diameter ϕD	Effective Length ℓ_1	Length of Cut ℓ	Neck Diameter ϕd_1	Shank Taper Angle Bta	Overall Length L	Shank Diameter ϕd	Price ¥	Effective Length by Inclined Angles				
									30°	1°	1° 30'	2°	3°
DCLS 2007-040	0.7	4	1.4	0.67	16°	45	4	16,000	4.55	4.85	5.08	5.29	5.68
DCLS 2007-060		6				45	4	16,000	6.69	7.04	7.31	7.56	8.13
DCLS 2007-080		8				45	4	16,000	8.80	9.19	9.51	9.84	10.58
DCLS 2007-100		10				45	4	16,000	10.90	11.33	11.71	12.12	13.03
DCLS 2008-040	0.8	4	1.6	0.77	16°	45	4	16,000	4.55	4.85	5.08	5.29	5.68
DCLS 2008-060		6				45	4	16,000	6.69	7.04	7.31	7.56	8.13
DCLS 2008-080		8				45	4	16,000	8.80	9.19	9.51	9.84	10.58
DCLS 2008-100		10				45	4	16,000	10.90	11.33	11.71	12.12	13.03
DCLS 2010-040	1	4	2	0.96	16°	45	4	16,000	4.57	4.86	5.09	5.30	5.70
DCLS 2010-060		6				45	4	16,000	6.70	7.05	7.32	7.57	8.14
DCLS 2010-080		8				45	4	16,000	8.82	9.20	9.52	9.85	10.59
DCLS 2010-100		10				45	4	16,000	10.91	11.34	11.72	12.13	13.04
DCLS 2010-160		16				50	4	16,000	17.16	17.73	18.32	18.96	20.38
DCLS 2010-210		21				55	4	16,000	22.33	23.05	23.82	24.65	26.50
DCLS 2015-060	1.5	6	3	1.44	16°	45	4	16,000	6.17	6.37	6.58	6.81	7.33
DCLS 2015-100		10				45	4	16,000	10.29	10.63	10.98	11.37	12.22
DCLS 2015-160		16				50	4	16,000	16.48	17.02	17.59	18.20	19.56
DCLS 2015-210		21				55	4	16,000	21.64	22.34	23.09	23.89	No Interference
DCLS 2020-060	2	6	4	1.9	16°	50	4	16,000	6.22	6.42	6.64	6.87	7.39
DCLS 2020-100		10				50	4	16,000	10.35	10.68	11.04	11.43	12.28
DCLS 2020-160		16				50	4	16,000	16.53	17.07	17.65	18.26	No Interference
DCLS 2020-210		21				55	4	16,000	21.69	22.40	23.15	23.95	No Interference
DCLS 2020-260		26				55	4	16,000	26.85	27.72	28.65	No Interference	No Interference
DCLS 2030-160		3				16	6	2.9	16°	70	6	18,000	16.53
DCLS 2030-210	21		70	6	20,000	21.69				22.40	23.15	23.95	25.74
DCLS 2030-260	26		70	6	20,000	26.85				27.72	28.65	29.65	No Interference
DCLS 2030-320	32		80	6	20,000	33.04				34.11	35.25	36.48	No Interference
DCLS 2040-210	4	21	8	3.91	16°	70	6	20,000	21.68	22.39	23.14	23.94	No Interference
DCLS 2040-260		26				70	6	20,000	26.84	27.71	28.64	No Interference	No Interference
DCLS 2040-320		32				70	6	20,000	33.03	34.10	35.24	No Interference	No Interference
DCLS 2040-420		42				80	6	23,000	43.34	44.75	No Interference	No Interference	No Interference
DCLS 2060-320	6	32	12	5.71	—	80	6	23,000	No Interference	No Interference	No Interference	No Interference	No Interference
DCLS 2060-420		42				80	6	23,000	No Interference	No Interference	No Interference	No Interference	No Interference
DCLS 2060-630		63				120	6	30,000	No Interference	No Interference	No Interference	No Interference	No Interference

UDC Series

CBN Series

Square
Long Neck Square

Radius

Radius
Long Neck Radius

Taper Neck Radius

Ball / Long Shank Ball

Ball
Long Neck Ball

Taper Neck Ball

Taper
Taper

Spiral V Cutter

Drill

EURO Series

Technical Data

Milling Conditions for DCLS

WORK MATERIAL			GRAPHITE				
Model Number	Outside Diameter (mm)	Effective Length (mm)	Spindle Speed (min ⁻¹)	Feed Rate (mm/min)	Side Milling		Slotting
					a _D Axial Depth (mm)	a _e Radial Depth (mm)	a _D Axial Depth (mm)
2004-020	0.4	2	34,000	410	0.4	0.02	0.02
2004-040		4	34,000	240	0.4	0.02	0.02
2004-060		6	34,000	180	0.4	0.02	0.02
2005-020	0.5	2	34,000	540	0.5	0.025	0.025
2005-040		4	34,000	350	0.5	0.025	0.025
2005-060		6	34,000	240	0.5	0.025	0.025
2006-020	0.6	2	34,000	660	0.6	0.03	0.03
2006-040		4	34,000	520	0.6	0.03	0.03
2006-060		6	34,000	320	0.6	0.03	0.03
2006-080		8	25,000	220	0.6	0.03	0.03
2006-100	0.7	10	24,000	120	0.6	0.03	0.03
2007-040		4	34,000	600	0.7	0.035	0.035
2007-060		6	34,000	380	0.7	0.035	0.035
2007-080		8	25,000	260	0.7	0.035	0.035
2007-100	0.8	10	24,000	140	0.7	0.035	0.035
2008-040		4	34,000	690	0.8	0.04	0.04
2008-060		6	34,000	440	0.8	0.04	0.04
2008-080		8	25,000	300	0.8	0.04	0.04
2008-100	1	10	24,000	170	0.8	0.04	0.04
2010-040		4	34,000	1,170	1	0.05	0.1
2010-060		6	26,000	850	1	0.05	0.1
2010-080		8	22,000	660	1	0.05	0.1
2010-100	1.5	10	22,100	530	1	0.05	0.1
2010-160		16	14,300	300	1	0.05	0.1
2010-210		21	12,500	200	1	0.05	0.1
2015-060		6	22,000	1,620	1.5	0.075	0.15
2015-100	2	10	17,000	1,050	1.5	0.075	0.15
2015-160		16	15,000	600	1.5	0.075	0.15
2015-210		21	10,000	370	1.5	0.075	0.15
2020-060		6	25,500	2,175	2	0.1	0.2
2020-100	3	10	21,000	1,680	2	0.1	0.2
2020-160		16	19,500	1,230	2	0.1	0.2
2020-210		21	16,500	750	2	0.1	0.2
2020-260		26	12,000	590	2	0.1	0.2
2030-160	4	16	22,000	2,200	3	0.15	0.3
2030-210		21	20,000	1,800	3	0.15	0.3
2030-260		26	18,000	1,450	3	0.15	0.3
2030-320		32	15,000	1,040	3	0.15	0.3
2040-210	6	21	14,000	1,760	4	0.2	0.4
2040-260		26	13,500	1,450	4	0.2	0.4
2040-320		32	13,000	1,160	4	0.2	0.4
2040-420		42	11,000	900	4	0.2	0.4
2060-320	6	32	12,000	1,500	6	0.6	1.2
2060-420		42	10,800	1,160	6	0.6	1.2
2060-630		63	7,400	620	6	0.6	1.2

UDC Series

CBN Series

Square
Long Neck Square

Radius

Radius
Long Neck Radius
Taper Neck Radius

Ball / Long Shark Ball
Long Neck Ball

Taper Neck Ball

Taper

Spiral V Cutter

Drill

EURO Series

Technical Data

Slotting
 a_p : Axial Depth (mm)
D : Outside Diameter (mm)

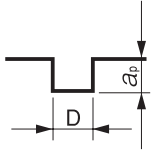

Side Milling
 a_p : Axial Depth (mm)
 a_e : Radial Depth (mm)

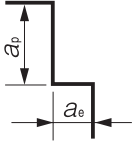

Note:
·Use a milling machine dedicated for Graphite.
·Recommend air blow for Graphite.

UDC Series

CBN Series

Square
Long Neck Square

Radius
Long Neck Radius
Taper Neck Radius

Ball / Long Shank Ball
Long Neck Ball
Taper Neck Ball

Taper
Taper

Spiral V Cutter

Drill

EURO Series

Technical Data



Size $\phi 0.5 \sim \phi 6$

CPR



($\phi 0.5 \sim \phi 2.5$) ($\phi 3$ or above)

Material Applications (☆ Highly Recommended ○ Recommended ○ Suggested)

Work Material															
Carbon Steels	Alloy Steels	Prehardened Steels	Hardened Steels			Cast Iron	Aluminum Alloys	Graphite	Copper	Plastics	Glass Filled Plastics	Titanium Alloys	Heat Resistant Alloys	Cemented Carbide	Hard Brittle (Non-Metallic) Materials
S45C	SK / SCM	NAK	~55HRC	~60HRC	~70HRC										
S55C	SUS	HPM													
							○		◎	☆					

Features

Long Neck Square End Mills for milling Plastics.
Designed especially for deep rib milling using an under cut design.

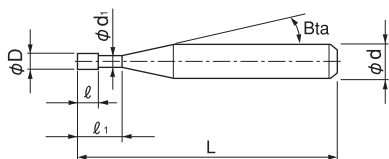

The shank taper angle shown is not an exact value and to avoid contact with the work piece, we recommend the user controls the precise value of this angle. Shank taper angle should not make contact with the work piece.

Total 64 models

Unit (mm)

Model Number	Outside Diameter ϕD	Effective Length ℓ_1	Length of Cut ℓ	Neck Diameter ϕd_1	Shank Taper Angle Bta	Overall Length L	Shank Diameter ϕd	Price ¥
CPR 2005-2	0.5	2	1	0.45	11°	38	3	6,700
CPR 2005-4		4				38	3	6,700
CPR 2005-6		6				38	3	6,700
CPR 2006-4	0.6	4	1.2	0.55	11°	38	3	6,000
CPR 2006-6		6				38	3	6,000
CPR 2007-4	0.7	4	1.4	0.65	11°	38	3	6,100
CPR 2007-6		6				38	3	6,100
CPR 2008-6	0.8	6	1.6	0.75	11°	45	4	5,100
CPR 2008-8		8				45	4	5,100
CPR 2009-6	0.9	6	1.8	0.85	11°	45	4	5,100
CPR 2009-10		10				45	4	5,100
CPR 2010-6		6				45	4	5,040
CPR 2010-8	1	8	2	0.9	11°	45	4	5,040
CPR 2010-10		10				45	4	5,040
CPR 2010-12		12				45	4	5,040
CPR 2010-16		16				50	4	5,040
CPR 2010-21		21				55	4	6,000
CPR 2012-6	1.2	6	2.4	1.1	11°	45	4	5,100
CPR 2012-8		8				45	4	5,100
CPR 2012-10		10				45	4	5,100
CPR 2012-12		12				50	4	5,100

Unit (mm)

Model Number	Outside Diameter ϕD	Effective Length ℓ_1	Length of Cut ℓ	Neck Diameter ϕd_1	Shank Taper Angle Bta	Overall Length L	Shank Diameter ϕd	Price ¥					
CPR 2014-6	1.4	6	2.8	1.3	11°	45	4	5,100					
CPR 2014-10		10				45		5,100					
CPR 2014-16		16				50		5,100					
CPR 2015-6	1.5	6	3	1.4	11°	45	4	5,100					
CPR 2015-10		10				45		5,100					
CPR 2015-14		14				50		5,100					
CPR 2015-16		16				50		5,100					
CPR 2015-21		21				55		5,100					
CPR 2016-6	1.6	6	3.2	1.5	11°	50	4	5,100					
CPR 2020-8	2	8	4	1.9	11°	50	4	5,040					
CPR 2020-10		10				50		5,040					
CPR 2020-12		12				50		5,040					
CPR 2020-14		14				50		5,040					
CPR 2020-16		16				50		5,040					
CPR 2020-18		18				55		5,040					
CPR 2020-21		21				55		5,040					
CPR 2020-26		26				55		5,100					
CPR 2020-32		32				70		6,100					
CPR 2025-12		2.5				12		5	2.3	11°	55	4	5,600
CPR 2025-21	21		55	5,600									
CPR 2030-8	3	8	6	2.8	11°	70	6	6,510					
CPR 2030-12		12				70		6,510					
CPR 2030-16		16				70		6,510					
CPR 2030-21		21				70		6,510					
CPR 2030-26		26				70		6,510					
CPR 2030-32		32				80		7,200					
CPR 2030-42		42				90		8,400					
CPR 2040-12		4				12		8	3.8	11°	70	6	6,930
CPR 2040-16						16					70		6,930
CPR 2040-18	18		70	6,930									
CPR 2040-21	21		70	6,930									
CPR 2040-24	24		70	6,930									
CPR 2040-32	32		70	6,930									
CPR 2040-36	36		70	6,930									
CPR 2040-42	42		80	7,250									
CPR 2040-52	52		100	9,350									
CPR 2050-16	5		16	10	4.8	11°	80				6		7,980
CPR 2050-22		22	80				7,980						
CPR 2050-32		32	80				7,980						
CPR 2060-12	6	No Under Cut	12	No Under Cut	—	80	6	7,670					
CPR 2060-42		42		80		7,980							
CPR 2060-52		52		120		11,030							
CPR 2060-63		63		120		11,030							

UDC Series

CBN Series

Square

Long Neck Square

Radius

Radius

Long Neck Radius

Taper Neck Radius

Ball / Long Shank Ball

Ball

Long Neck Ball

Taper Neck Ball

Taper

Spiral V Cutter

Drill

EURO Series

Technical Data

Milling Conditions for CPR

WORK MATERIAL			ABS / MC NYLON			ACRYLIC / POLYACETAL			POLYCARBONATE			GLASS FIBER REINFORCED POLYCARBONATE		
Model Number	Outside Diameter (mm)	Effective Length (mm)	Spindle Speed (min ⁻¹)	Feed Rate (mm/min)	a _D Axial Depth (mm)	Spindle Speed (min ⁻¹)	Feed Rate (mm/min)	a _D Axial Depth (mm)	Spindle Speed (min ⁻¹)	Feed Rate (mm/min)	a _D Axial Depth (mm)	Spindle Speed (min ⁻¹)	Feed Rate (mm/min)	a _D Axial Depth (mm)
UDC Series	0.5	2	6,000	300	0.2	15,000	300	0.2	9,000	300	0.2	9,000	450	0.2
		4	6,000	300	0.2	15,000	300	0.2	9,000	300	0.2	9,000	450	0.2
		6	6,000	300	0.2	15,000	300	0.2	9,000	300	0.2	9,000	450	0.2
CBN Series	0.6	4	6,000	340	0.2	14,400	300	0.2	8,800	540	0.2	8,800	810	0.2
		6	6,000	340	0.2	14,400	300	0.2	8,800	540	0.2	8,800	810	0.2
Square	0.7	4	6,000	380	0.2	13,800	300	0.2	8,600	780	0.2	8,600	1,170	0.2
		6	6,000	380	0.2	13,800	300	0.2	8,600	780	0.2	8,600	1,170	0.2
Long Neck Square	0.8	6	6,000	420	0.2	13,200	300	0.2	8,400	1,000	0.2	8,400	1,500	0.2
		8	6,000	420	0.2	12,900	280	0.2	8,200	960	0.2	8,200	1,440	0.2
Radius	0.9	6	6,000	460	0.2	12,600	300	0.2	8,200	1,300	0.2	8,200	1,950	0.2
		10	6,000	460	0.2	11,800	260	0.2	7,800	1,000	0.2	7,800	1,500	0.2
Long Neck Radius	1	6	6,000	500	0.3	12,000	300	0.3	8,000	1,500	0.3	8,000	2,250	0.3
		8	6,000	500	0.3	11,500	270	0.3	7,700	1,400	0.3	7,700	2,100	0.3
Taper Neck Radius	1.2	10	6,000	500	0.3	11,000	240	0.3	7,500	1,200	0.3	7,500	1,800	0.3
		12	6,000	500	0.3	10,400	220	0.3	7,200	1,100	0.3	7,200	1,650	0.3
Ball / Long Shark Ball	1.4	16	6,000	500	0.3	9,300	160	0.3	6,700	830	0.3	6,700	1,245	0.3
		21	6,000	500	0.3	8,000	90	0.3	6,000	500	0.3	6,000	750	0.3
Long Neck Ball	1.5	6	6,000	610	0.4	11,700	330	0.4	8,000	1,500	0.4	8,000	2,250	0.4
		8	6,000	610	0.4	11,200	300	0.4	7,700	1,400	0.4	7,700	2,100	0.4
Taper	1.6	10	6,000	600	0.4	10,700	280	0.4	7,500	1,300	0.4	7,500	1,950	0.4
		12	6,000	600	0.4	10,200	250	0.4	7,200	1,200	0.4	7,200	1,800	0.4
Spiral V Cutter	2	6	6,000	720	0.4	11,340	360	0.4	8,000	1,600	0.4	8,000	2,400	0.4
		10	6,000	700	0.4	10,700	310	0.4	7,700	1,400	0.4	7,700	2,100	0.4
Drill	2.5	16	6,000	680	0.4	9,800	230	0.4	7,200	1,000	0.4	7,200	1,500	0.4
		6	6,100	780	0.5	11,200	380	0.5	8,000	1,600	0.5	8,000	1,700	0.5
EURO Series	2	10	6,000	760	0.5	10,200	330	0.5	7,500	1,400	0.5	7,500	1,600	0.5
		14	6,000	730	0.5	9,600	270	0.5	7,000	1,100	0.5	7,000	1,400	0.5
Technical Data	2	16	6,000	730	0.5	8,800	250	0.5	6,700	1,000	0.5	6,700	1,400	0.5
		21	5,900	700	0.5	7,600	180	0.5	6,100	750	0.5	6,100	1,200	0.5
Taper	2	6	6,100	830	0.8	11,000	390	0.8	8,000	1,600	0.8	8,000	1,700	0.8
		8	6,100	1,000	1	10,100	440	1	7,900	1,700	1	7,900	1,800	1
Ball	2	10	6,000	980	1	9,800	420	1	7,700	1,600	1	7,700	1,800	1
		12	6,000	970	1	9,500	400	1	7,500	1,600	1	7,500	1,700	1
Long Neck Taper	2	14	5,900	950	1	9,100	380	1	7,300	1,500	1	7,300	1,700	1
		16	5,900	930	1	8,800	360	1	7,100	1,400	1	7,100	1,600	1
Drill	2	18	5,800	920	1	8,500	340	1	6,900	1,300	1	6,900	1,600	1
		21	5,700	890	1	8,000	300	1	6,500	1,200	1	6,500	1,500	1
EURO Series	2	26	5,600	850	1	7,200	250	1	6,000	1,100	1	6,000	1,400	1
		32	5,400	800	1	6,200	190	1	5,400	850	1	5,400	1,300	1
Technical Data	2.5	12	6,000	1,300	1.2	8,600	480	1.2	7,400	1,600	1.2	7,400	1,900	1.2
		21	5,700	1,100	1	6,800	350	1	6,200	1,300	1	6,200	1,600	1

Milling Conditions for CPR

WORK MATERIAL			ABS / MC NYLON			ACRYLIC / POLYACETAL			POLYCARBONATE			GLASS FIBER REINFORCED POLYCARBONATE		
Model Number	Outside Diameter (mm)	Effective Length (mm)	Spindle Speed (min ⁻¹)	Feed Rate (mm/min)	a_D Axial Depth (mm)	Spindle Speed (min ⁻¹)	Feed Rate (mm/min)	a_D Axial Depth (mm)	Spindle Speed (min ⁻¹)	Feed Rate (mm/min)	a_D Axial Depth (mm)	Spindle Speed (min ⁻¹)	Feed Rate (mm/min)	a_D Axial Depth (mm)
2030-8	3	8	6,200	1,600	1.5	8,700	610	1.5	8,000	1,900	1.5	8,000	2,200	1.5
2030-12		12	6,000	1,500	1.5	8,000	560	1.5	7,500	1,800	1.5	7,500	2,100	1.5
2030-16		16	5,800	1,400	1.5	7,300	510	1.5	7,000	1,700	1.5	7,000	2,000	1.5
2030-21		21	5,600	1,300	1.5	6,400	440	1.5	6,300	1,500	1.5	6,300	1,800	1.5
2030-26		26	5,400	1,200	1.5	5,500	370	1.5	5,600	1,400	1.5	5,600	1,700	1.5
2030-32		32	5,200	1,100	1.5	4,500	290	1.5	4,800	1,200	1.5	4,800	1,400	1.5
2030-42		42	4,800	960	1.5	2,700	160	1.5	3,500	840	1.5	3,500	1,000	1.5
2040-12	4	12	5,000	1,400	2	7,000	520	2	5,800	1,500	2	5,800	1,800	2
2040-16		16	4,900	1,400	2	6,500	480	2	5,500	1,400	2	5,500	1,700	2
2040-18		18	4,800	1,400	2	6,300	470	2	5,400	1,400	2	5,400	1,700	2
2040-21		21	4,800	1,400	2	6,000	440	2	5,100	1,300	2	5,100	1,600	2
2040-24		24	4,700	1,300	2	5,600	410	2	4,900	1,300	2	4,900	1,600	2
2040-32		32	4,500	1,300	2	4,700	340	2	4,400	1,100	2	4,400	1,500	2
2040-36		36	4,300	1,300	2	4,200	300	2	4,100	1,100	2	4,100	1,400	2
2040-42		42	4,200	1,300	2	3,600	250	2	3,600	960	2	3,600	1,200	2
2040-52	52	3,900	1,200	2	2,400	160	2	2,900	780	2	2,900	1,000	2	
2050-16	5	16	3,400	1,200	2.5	5,800	470	2.5	4,000	1,200	2.5	4,000	1,400	2.5
2050-22		22	3,300	1,100	2.5	5,100	390	2.5	3,600	1,100	2.5	3,600	1,300	2.5
2050-32		32	3,200	1,100	2.5	3,900	260	2.5	2,900	910	2.5	2,900	1,100	2.5
2060-12	6	12	3,000	1,200	3	5,000	450	3	2,500	1,000	3	2,500	1,500	3
2060-42		42	2,400	960	3	2,600	240	3	1,900	760	3	1,900	1,140	3
2060-52		52	2,200	890	3	1,900	170	3	1,700	670	3	1,700	1,005	3
2060-63		63	2,000	800	3	1,000	90	3	1,500	600	3	1,500	900	3

Milling Amount for Slotting (mm)

$$a_p \leq 0.5D$$

 a_p : Axial Depth (mm)

D : Outside Diameter (mm)

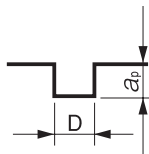

CPR Finishing Conditions for Side Milling

Refer to the slotting parameters for speeds and feeds.

Set the milling amount as below during side milling finishing.

Milling Amount for Side Finishing (mm)

 a_p : Axial Depth (mm) a_e : Radial Depth (mm) a_e : 0.01 ~ 0.015D (Min 0.01 mm)

D : Outside Diameter (mm)

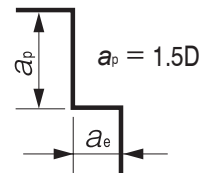

Note:

- Control the radial depth (a_e) by approximately 0.01-0.015 times of the outside diameter or set to 0.01 mm the minimum during side milling finishing.
- Increase the feed rate per flute to reduce burring on surface of softer materials.
- Chattering may occur when using a spindle with low rigidity or when milling unstable work piece. Reduce the milling amount in this case.
- Recommend to reduce the milling amount when using a machine with low spindle speed. Not recommend to reduce the feed rate.
- Recommend water soluble coolant for Copper and Aluminum Alloys.
- Recommend air blow for Plastics.
- Remove chips from the work piece to keep the milling surface quality.
- If chips clog on the tool, stop the operation and remove them accordingly.

UDC Series
CBN Series
Square
Long Neck Square
Radius
Long Neck Radius
Taper Neck Radius
Ball / Long Shank Ball
Long Neck Ball
Taper Neck Ball
Taper
Spiral V Cutter
Drill
EURO Series
Technical Data



Size $\phi 0.5 \sim \phi 4$

CPRL



($\phi 0.5 \sim \phi 2$) ($\phi 3$ or above)

Material Applications (☆ Highly Recommended ● Recommended ○ Suggested)

Work Material															
Carbon Steels	Alloy Steels	Prehardened Steels	Hardened Steels			Cast Iron	Aluminum Alloys	Graphite	Copper	Plastics	Glass Filled Plastics	Titanium Alloys	Heat Resistant Alloys	Cemented Carbide	Hard Brittle (Non-Metallic) Materials
S45C	SK / SCM	NAK	~55HRC	~60HRC	~70HRC										
S55C	SUS	HPM													
							○		●	☆					

Features

Long Neck & Shank Square End Mills for milling Plastics.
High performance for deep rib cut milling.
Excellent cutting performance for milling Plastics.

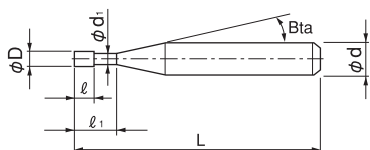

The shank taper angle shown is not an exact value and to avoid contact with the work piece, we recommend the user controls the precise value of this angle. Shank taper angle should not make contact with the work piece.

Total 36 models

Unit (mm)

Model Number	Outside Diameter ϕD	Effective Length l_1	Length of Cut l	Neck Diameter ϕd_1	Shank Taper Angle Bta	Overall Length L	Shank Diameter ϕd	Price ¥
CPRL 2005-4	0.5	4	1	0.45	11°	80	4	8,000
CPRL 2005-6		6				80	4	8,000
CPRL 2005-8		8				80	4	9,000
CPRL 2005-10		10				80	4	9,800
CPRL 2010-6	1	6	2	0.9	11°	80	4	6,000
CPRL 2010-8		8				80	4	6,000
CPRL 2010-10		10				80	4	6,000
CPRL 2010-12		12				80	4	6,000
CPRL 2010-14		14				80	4	6,000
CPRL 2010-16		16				80	4	6,000
CPRL 2010-18		18				80	4	7,200
CPRL 2010-21		21				80	4	7,800
CPRL 2015-6	1.5	6	3	1.4	11°	80	4	6,000
CPRL 2015-8		8				80	4	6,000
CPRL 2015-10		10				80	4	6,000
CPRL 2015-14		14				80	4	6,000
CPRL 2015-16		16				80	4	6,000
CPRL 2015-21		21				80	4	6,000

Unit (mm)

Model Number	Outside Diameter ϕD	Effective Length ℓ_1	Length of Cut ℓ	Neck Diameter ϕd_1	Shank Taper Angle Bta	Overall Length L	Shank Diameter ϕd	Price ¥
CPRL 2020-8	2	8	4	1.9	11°	80	4	6,000
CPRL 2020-10		10				80	4	6,000
CPRL 2020-12		12				80	4	6,000
CPRL 2020-14		14				80	4	6,000
CPRL 2020-16		16				80	4	6,000
CPRL 2020-18		18				80	4	6,000
CPRL 2020-21		21				80	4	6,000
CPRL 2020-26		26				80	4	6,000
CPRL 2020-32		32				80	4	6,000
CPRL 2020-40		40				100	4	9,400
CPRL 2030-12	3	12	6	2.8	11°	100	6	7,800
CPRL 2030-16		16				100	6	7,800
CPRL 2030-21		21				100	6	7,800
CPRL 2030-26		26				100	6	7,800
CPRL 2030-32		32				100	6	8,600
CPRL 2040-18	4	18	8	3.8	11°	100	6	8,300
CPRL 2040-24		24				100	6	8,300
CPRL 2040-32		32				100	6	8,300

CPRL Series
Acrylic
Milling Video



UDC Series

CBN Series

Square
Long Neck Square

Radius

Radius
Long Neck Radius

Radius
Taper Neck Radius

Ball / Long Shank Ball

Ball
Long Neck Ball

Ball
Taper Neck Ball

Taper
Taper

Spiral
V Cutter

Drill

EURO Series

Technical Data

Milling Conditions for CPRL

Model Number	Outside Diameter (mm)	Effective Length (mm)	ABS / MC NYLON				ACRYLIC / POLYACETAL				POLYCARBONATE				GLASS FIBER REINFORCED POLYCARBONATE			
			Spindle Speed (min ⁻¹)	Feed Rate (mm/min)	a _p Axial Depth (mm)	a _e Radial Depth (mm)	Spindle Speed (min ⁻¹)	Feed Rate (mm/min)	a _p Axial Depth (mm)	a _e Radial Depth (mm)	Spindle Speed (min ⁻¹)	Feed Rate (mm/min)	a _p Axial Depth (mm)	a _e Radial Depth (mm)	Spindle Speed (min ⁻¹)	Feed Rate (mm/min)	a _p Axial Depth (mm)	a _e Radial Depth (mm)
2005-4	0.5	4	6,000	300	0.2	0.5	15,000	300	0.2	0.5	9,000	300	0.2	0.5	9,000	90	0.2	0.5
2005-6		6	6,000	300	0.2	0.5	15,000	300	0.2	0.5	9,000	300	0.2	0.5	9,000	90	0.2	0.5
2005-8		8	6,000	300	0.2	0.5	15,000	300	0.2	0.5	9,000	300	0.2	0.5	9,000	90	0.2	0.5
2005-10		10	6,000	300	0.2	0.5	15,000	300	0.2	0.5	9,000	300	0.2	0.5	9,000	90	0.2	0.5
2010-6		6	6,000	500	0.3	1	12,000	300	0.3	1	8,000	1,500	0.3	1	8,000	1,500	0.3	1
2010-8	8	6,000	500	0.3	1	11,500	270	0.3	1	7,700	1,400	0.3	1	7,700	1,400	0.3	1	
2010-10	10	6,000	500	0.3	1	11,000	240	0.3	1	7,500	1,200	0.3	1	7,500	1,400	0.3	1	
2010-12	12	6,000	500	0.3	1	10,400	220	0.3	1	7,200	1,100	0.3	1	7,200	1,300	0.3	1	
2010-14	14	6,000	500	0.3	1	9,900	190	0.3	1	6,900	970	0.3	1	6,900	1,200	0.3	1	
2010-16	16	6,000	500	0.3	1	9,300	160	0.3	1	6,700	830	0.3	1	6,700	1,200	0.3	1	
2010-18	18	6,000	500	0.3	1	8,800	130	0.3	1	6,400	700	0.3	1	6,400	1,100	0.3	1	
2010-21	21	6,000	500	0.3	1	8,000	90	0.3	1	6,000	500	0.3	1	6,000	1,000	0.3	1	
2015-6	1.5	6	6,100	780	0.5	1.5	11,200	380	0.5	1.5	8,000	1,600	0.5	1.5	8,000	1,700	0.5	1.5
2015-8		8	6,100	770	0.5	1.5	10,700	350	0.5	1.5	7,700	1,500	0.5	1.5	7,700	1,600	0.5	1.5
2015-10		10	6,000	760	0.5	1.5	10,200	330	0.5	1.5	7,500	1,400	0.5	1.5	7,500	1,600	0.5	1.5
2015-14		14	6,000	730	0.5	1.5	9,600	270	0.5	1.5	7,000	1,100	0.5	1.5	7,000	1,400	0.5	1.5
2015-16		16	6,000	730	0.5	1.5	8,800	250	0.5	1.5	6,700	1,000	0.5	1.5	6,700	1,400	0.5	1.5
2015-21	21	5,900	700	0.5	1.5	7,600	180	0.5	1.5	6,100	750	0.5	1.5	6,100	1,200	0.5	1.5	
2020-8	2	8	6,100	1,000	1	2	10,100	440	1	2	7,900	1,700	1	2	7,900	1,800	1	2
2020-10		10	6,000	980	1	2	9,800	420	1	2	7,700	1,600	1	2	7,700	1,800	1	2
2020-12		12	6,000	970	1	2	9,500	400	1	2	7,500	1,600	1	2	7,500	1,700	1	2
2020-14		14	5,900	950	1	2	9,100	380	1	2	7,300	1,500	1	2	7,300	1,700	1	2
2020-16		16	5,900	930	1	2	8,800	360	1	2	7,100	1,400	1	2	7,100	1,600	1	2
2020-18		18	5,800	920	1	2	8,500	340	1	2	6,900	1,300	1	2	6,900	1,600	1	2
2020-21		21	5,700	890	1	2	8,000	300	1	2	6,500	1,200	1	2	6,500	1,500	1	2
2020-26		26	5,600	850	1	2	7,200	250	1	2	6,000	1,100	1	2	6,000	1,400	1	2
2020-32		32	5,400	800	1	2	6,200	190	1	2	5,400	850	1	2	5,400	1,300	1	2
2020-40		40	5,200	730	1	2	4,900	110	1	2	4,600	570	1	2	4,600	1,100	1	2
2030-12	3	12	6,000	1,500	1.5	3	8,000	560	1.5	3	7,500	1,800	1.5	3	7,500	2,100	1.5	3
2030-16		16	5,800	1,400	1.5	3	7,300	510	1.5	3	7,000	1,700	1.5	3	7,000	2,000	1.5	3
2030-21		21	5,600	1,300	1.5	3	6,400	440	1.5	3	6,300	1,500	1.5	3	6,300	1,800	1.5	3
2030-26		26	5,400	1,200	1.5	3	5,500	370	1.5	3	5,600	1,400	1.5	3	5,600	1,700	1.5	3
2030-32		32	5,200	1,100	1.5	3	4,500	290	1.5	3	4,800	1,200	1.5	3	4,800	1,400	1.5	3
2040-18	4	18	4,800	1,400	2	4	6,300	470	2	4	5,400	1,400	2	4	5,400	1,700	2	4
2040-24		24	4,700	1,300	2	4	5,600	410	2	4	4,900	1,300	2	4	4,900	1,600	2	4
2040-32		32	4,500	1,300	2	4	4,700	340	2	4	4,400	1,100	2	4	4,400	1,500	2	4

Milling Amount for Slotting (mm)

$a_p \leq 0.5D$

a_p : Axial Depth (mm)

D : Outside Diameter (mm)

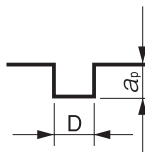

CPRL Finishing Conditions for Side Milling

Refer to the slotting parameters for speeds and feeds. Set the milling amount as below during side milling finishing.

Milling Amount for Side Finishing (mm)

a_p : Axial Depth (mm)

a_e : Radial Depth (mm)

a_e : 0.01 ~ 0.015D (Min 0.01 mm)

D : Outside Diameter (mm)

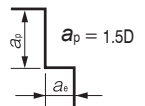

Drill

EURO Series

Technical Data

Milling Conditions for CPRL

- Note:
- Control the radial depth (a_e) by approximately 0.01-0.015 times of the outside diameter or set to 0.01 mm the minimum during side milling finishing.
 - Increase the feed per tooth to reduce burr on surface of softer materials.
 - Chattering may occur when using a spindle with low rigidity or when milling unstable work piece. Reduce the milling amount in this case.
 - Recommend to reduce the milling amount when using a machine with low spindle speed. Not recommend to reduce the feed rate.
 - Recommend water soluble coolant for Copper and Aluminum Alloys.
 - Recommend air blow for Plastics.
 - Remove chips from the work piece to keep the milling surface quality.
 - If chips clog on the tool, stop the operation and remove them accordingly.

UDC Series

CBN Series

Square

Square

Long Neck Square

Radius

Radius

Long Neck Radius

Taper Neck Radius

Ball / Long Shank Ball

Ball

Long Neck Ball

Taper Neck Ball

Taper

Taper

Spiral V Cutter

Drill

EURO Series

Technical Data



Size $\phi 1 \sim \phi 12$

AZS



Material Applications (☆ Highly Recommended ○ Recommended ○ Suggested)

Work Material															
Carbon Steels S45C S55C	Alloy Steels SK / SCM SUS	Prehardened Steels NAK HPM	Hardened Steels			Cast Iron	Aluminum Alloys	Graphite	Copper	Plastics	Glass Filled Plastics	Titanium Alloys	Heat Resistant Alloys	Cemented Carbide	Hard Brittle (Non-Metallic) Materials
			~55HRC	~60HRC	~70HRC										
							☆		○	○					

Features

- Capable of verical milling into a flat surface.
- Achieves shorter processing time by removing pre-drilling or ramping cycle.
- 45° helix angle offers excellent chip evacuation.
- The flute shape is specifically designed for reducing burrs on Aluminum Alloys.
- The micro flatland design greatly helps control of chipping.

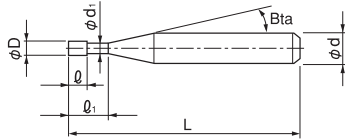

The shank taper angle shown is not an exact value and to avoid contact with the work piece, we recommend the user controls the precise value of this angle. Shank taper angle should not make contact with the work piece.

Diameter Tolerance

Outside Diameter (ϕD)	Tolerance
$\phi 1 \sim \phi 6, \phi 7, \phi 9, \phi 11$	0 -0.015
$\phi 8, \phi 10, \phi 12$	0 -0.005

Micro Flatland Design

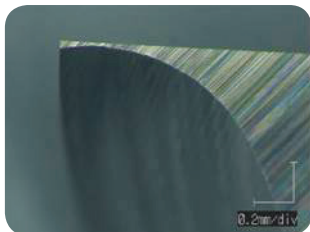

Excellent sharpness + Chipping protection design

Smooth Flute Design

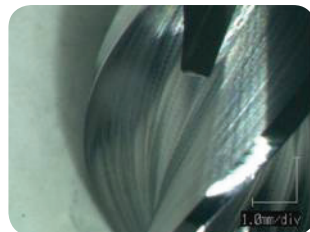

Outstanding chip evacuation by seamless flute.

3 Flute Design

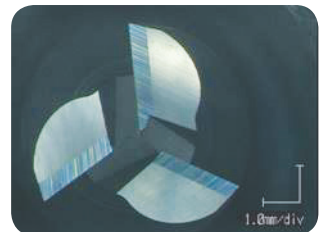

Highly efficient 3 flutes. Significant productivity improvement.

Total 28 models

Unit (mm)

Model Number	Outside Diameter ϕD	Effective Length ℓ_1	Length of Cut ℓ	Neck Diameter ϕd_1	Shank Taper Angle $B\alpha$	Overall Length L	Shank Diameter ϕd	Price ¥
AZS 3010-030	1	3	2	0.95	16°	60	4	5,880
AZS 3010-050		5				60		6,400
AZS 3015-045	1.5	4.5	3	1.43	16°	60	4	5,880
AZS 3020-060	2	6	4	1.93	16°	60	4	5,880
AZS 3020-100		10				60		6,400
AZS 3025-075	2.5	7.5	5	2.4	16°	60	4	7,080
AZS 3030-090	3	9	6	2.9	16°	70	6	7,080
AZS 3030-150		15				70		7,700
AZS 3035-105	3.5	10.5	7	3.4	16°	70	6	7,320
AZS 3040-120	4	12	8	3.9	16°	70	6	7,320
AZS 3040-200		20				70		8,000
AZS 3045-135	4.5	13.5	9	4.4	16°	70	6	7,920
AZS 3050-150	5	15	10	4.9	16°	70	6	7,920
AZS 3050-250		25				70		8,700
AZS 3060-180	6	18	12	5.8	—	70	6	8,280
AZS 3060-300		30				70		9,100
AZS 3070-210	7	21	14	6.82	16°	80	8	11,040
AZS 3070-350		35				80		12,100
AZS 3080-240	8	24	16	7.82	—	80	8	11,040
AZS 3080-400		40				80		12,100
AZS 3090-270	9	27	18	8.82	16°	90	10	13,920
AZS 3090-450		45				90		15,300
AZS 3100-300	10	30	20	9.82	—	90	10	13,920
AZS 3100-500		50				90		15,300
AZS 3110-330	11	33	22	10.82	16°	110	12	19,560
AZS 3110-550		55				110		21,500
AZS 3120-360	12	36	24	11.82	—	110	12	19,560
AZS 3120-600		60				110		21,500

3 Flutes

UDC Series

CBN Series

Square

Square

Long Neck Square

Radius

Radius

Long Neck Radius

Taper Neck Radius

Ball / Long Shank Ball

Ball

Long Neck Ball

Taper Neck Ball

Taper

Taper

Spiral V Cutter

Drill

EURO Series

Technical Data

Roughing Example

A5052

Model Number	Milling Process	Spindle Speed	Z Feed Rate	XY Feed Rate	Axial Depth a_p	Radial Depth a_e	Cycle Time
AZS 3100-300 ($\phi 10 \times$ Effective Length 30)	Drilling ①	6,480 min ⁻¹	180 mm/min	—	10 mm	—	6 min 35 sec
	Roughing		—	1,500 mm/min	10 mm	5 mm	
	Drilling ②		180 mm/min	—	20 mm	—	
	Roughing		—	1,500 mm/min	20 mm	5 mm	
AZS 3030-090 ($\phi 3 \times$ Effective Length 9)	Drilling + Slotting	14,000 min ⁻¹	145 mm/min	1,450 mm/min	3 mm	—	30 sec

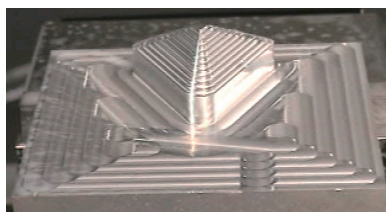

Coolant : Water Soluble

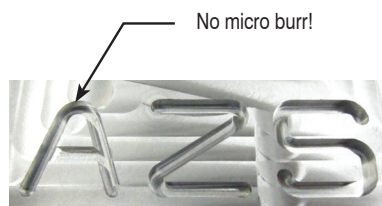

No micro burr!

Pocket Milling Example

A7075

Tool	AZS 3060-180 ($\phi 6 \times$ Effective Length 18)	
Milling Process	Roughing	Finishing
Spindle Speed	17,600 min ⁻¹	17,600 min ⁻¹
Feed Rate	3,000 mm/min	2,000 mm/min
Axial Depth a_p	6 mm	6 mm
Radial Depth a_e	4.8 mm	0.3 mm

AZS series
A7075
Milling Video



Bottom

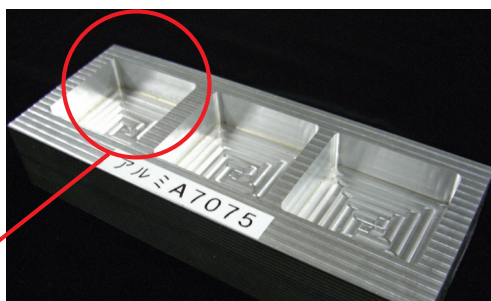

Milling from roughing to finishing with 1 pc.

Pocket size : 50 mm x 50 mm x 18 mm
Coolant : Oil Mist

UDC Series

CBN Series

Square

Square

Long Neck Square

Radius

Radius

Long Neck Radius

Taper Neck Radius

Ball

Ball / Long Shank Ball

Long Neck Ball

Taper Neck Ball

Taper

Taper

Spiral V Cutter

Drill

EURO Series

Technical Data



Size $\phi 1 \sim \phi 12$

DLC-AZS



Material Applications (☆ Highly Recommended ○ Recommended ○ Suggested)

Work Material															
Carbon Steels S45C S55C	Alloy Steels SK / SCM SUS	Prehardened Steels NAK HPM	Hardened Steels			Cast Iron	Aluminum Alloys	Graphite	Copper	Plastics	Glass Filled Plastics	Titanium Alloys	Heat Resistant Alloys	Cemented Carbide	Hard Brittle (Non-Metallic) Materials
			~55HRC	~60HRC	~70HRC										
							☆		○	○					

Features

- Capable of vertical milling directly into a plane surface.
- Achieves shorter processing time by removing pre-drilling or ramping cycle.
- DLC COAT offers excellent resistance to wear and welding.
- 45° helix angle offers excellent chip evacuation.
- The flute shape is specifically designed for reducing burrs on Aluminum Alloys.
- The micro flatland design greatly helps control of chipping.

The shank taper angle shown is not an exact value and to avoid contact with the work piece, we recommend the user controls the precise value of this angle. Shank taper angle should not make contact with the work piece.

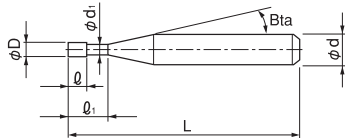

Diameter Tolerance

Outside Diameter (φD)	Tolerance
$\phi 1 \sim \phi 6, \phi 7, \phi 9, \phi 11$	0 -0.015
$\phi 8, \phi 10, \phi 12$	0 -0.005

Total 28 models

Unit (mm)

Model Number	Outside Diameter ϕD	Effective Length ℓ_1	Length of Cut ℓ	Neck Diameter ϕd_1	Shank Taper Angle βta	Overall Length L	Shank Diameter ϕd	Price ¥
DLC-AZS 3010-030	1	3	2	0.95	16°	60	4	6,200
DLC-AZS 3010-050		5						6,750
DLC-AZS 3015-045	1.5	4.5	3	1.43	16°	60	4	6,200
DLC-AZS 3020-060	2	6	4	1.93	16°	60	4	6,200
DLC-AZS 3020-100		10						6,750
DLC-AZS 3025-075	2.5	7.5	5	2.4	16°	60	4	7,400
DLC-AZS 3030-090	3	9	6	2.9	16°	70	6	7,400
DLC-AZS 3030-150		15						8,050

Unit (mm)

Model Number	Outside Diameter ϕD	Effective Length ℓ_1	Length of Cut ℓ	Neck Diameter ϕd_1	Shank Taper Angle $B\alpha$	Overall Length L	Shank Diameter ϕd	Price ¥
DLC-AZS 3035-105	3.5	10.5	7	3.4	16°	70	6	7,700
DLC-AZS 3040-120	4	12	8	3.9	16°	70	6	7,700
DLC-AZS 3040-200		20				70	6	8,420
DLC-AZS 3045-135	4.5	13.5	9	4.4	16°	70	6	8,300
DLC-AZS 3050-150	5	15	10	4.9	16°	70	6	8,300
DLC-AZS 3050-250		25				70	6	9,120
DLC-AZS 3060-180	6	18	12	5.8	—	70	6	8,700
DLC-AZS 3060-300		30				70	6	9,560
DLC-AZS 3070-210	7	21	14	6.82	16°	80	8	11,600
DLC-AZS 3070-350		35				80	8	12,710
DLC-AZS 3080-240	8	24	16	7.82	—	80	8	11,600
DLC-AZS 3080-400		40				80	8	12,710
DLC-AZS 3090-270	9	27	18	8.82	16°	90	10	14,600
DLC-AZS 3090-450		45				90	10	16,050
DLC-AZS 3100-300	10	30	20	9.82	—	90	10	14,600
DLC-AZS 3100-500		50				90	10	16,050
DLC-AZS 3110-330	11	33	22	10.82	16°	110	12	20,500
DLC-AZS 3110-550		55				110	12	22,530
DLC-AZS 3120-360	12	36	24	11.82	—	110	12	20,500
DLC-AZS 3120-600		60				110	12	22,530

3 Flutes

UDC Series

CBN Series

Square

Long Neck Square

Radius

Radius

Long Neck Radius

Taper Neck Radius

Ball / Long Shank Ball

Ball

Long Neck Ball

Taper Neck Ball

Taper

Taper

Spiral V Cutter

Drill

EURO Series

Technical Data

Milling Conditions for AZS / DLC-AZS

◆ High speed & highly efficient milling conditions

WORK MATERIAL			A5052							
Model Number	Outside Diameter (mm)	Effective Length (mm)	Spindle Speed (min ⁻¹)	Vertical		Slotting		Side Milling		
				Feed Rate (mm/min)	a _p (mm)	Feed Rate (mm/min)	a _p (mm)	Feed Rate (mm/min)	a _p (mm)	a _e (mm)
3010-030	1	3	30,000	150	0.75	900	0.75	1,100	0.75	0.3
3010-050		5	22,500	100	0.75	600	0.75	800	0.75	0.3
3015-045	1.5	4.5	30,000	180	1.125	1,350	1.125	1,630	1.125	0.45
3020-060	2	6	30,000	225	1.5	1,800	1.5	2,150	1.5	0.6
3020-100		10	22,500	150	1.5	1,300	1.5	1,500	1.5	0.6
3025-075	2.5	7.5	25,000	225	1.875	1,900	1.875	2,300	1.875	0.75
3030-090	3	9	21,600	225	2.25	2,000	2.25	2,400	2.25	0.9
3030-150		15	16,200	150	2.25	1,400	2.25	1,700	2.25	0.9
3035-105	3.5	10.5	18,500	270	2.625	2,000	2.625	2,400	2.625	1.05
3040-120	4	12	16,200	300	3	2,000	3	2,400	3	1.2
3040-200		20	12,200	200	3	1,400	3	1,700	3	1.2
3045-135	4.5	13.5	14,400	300	3.375	2,000	3.375	2,400	3.375	1.35
3050-150	5	15	12,960	300	3.75	2,000	3.75	2,400	3.75	1.5
3050-250		25	9,700	200	3.75	1,400	3.75	1,700	3.75	1.5
3060-180	6	18	10,800	300	4.5	2,000	4.5	2,400	4.5	1.8
3060-300		30	8,100	200	4.5	1,400	4.5	1,700	4.5	1.8
3070-210	7	21	9,300	300	5.25	2,000	5.25	2,400	5.25	2.1
3070-350		35	6,900	200	5.25	1,400	5.25	1,700	5.25	2.1
3080-240	8	24	11,400	300	6	2,200	6	2,600	6	2.4
3080-400		40	8,600	200	6	1,500	6	1,800	6	2.4
3090-270	9	27	7,200	275	6.75	2,000	6.75	2,400	6.75	2.7
3090-450		45	5,400	180	6.75	1,400	6.75	1,700	6.75	2.7
3100-300	10	30	9,100	250	7.5	2,200	7.5	2,600	7.5	3
3100-500		50	6,800	160	7.5	1,500	7.5	1,800	7.5	3
3110-330	11	33	5,900	225	8.25	2,000	8.25	2,400	8.25	3.3
3110-550		55	4,400	145	8.25	1,400	8.25	1,700	8.25	3.3
3120-360	12	36	7,600	200	9	2,200	9	2,600	9	3.6
3120-600		60	5,700	130	9	1,500	9	1,800	9	3.6
Milling Amount (mm)				a _p =0.75D		a _p =0.75D		a _p =0.75D a _e =0.3D		

UDC Series

CBN Series

Square
Long Neck Square

Radius
Long Neck Radius
Taper Neck Radius

Ball / Long Shark Ball
Long Neck Ball
Taper Neck Ball

Taper

Spiral V Cutter

Drill

EURO Series

Technical Data

Milling Conditions for AZS / DLC-AZS

WORK MATERIAL			A7075							
Model Number	Outside Diameter (mm)	Effective Length (mm)	Spindle Speed (min ⁻¹)	Vertical		Slotting		Side Milling		
				Feed Rate (mm/min)	a_p (mm)	Feed Rate (mm/min)	a_p (mm)	Feed Rate (mm/min)	a_p (mm)	a_e (mm)
3010-030	1	3	30,000	150	0.75	540	0.75	860	0.75	0.3
3010-050		5	22,500	100	0.75	400	0.75	600	0.75	0.3
3015-045	1.5	4.5	30,000	180	1.125	820	1.125	1,230	1.125	0.45
3020-060	2	6	30,000	225	1.5	1,100	1.5	1,600	1.5	0.6
3020-100		10	22,500	150	1.5	800	1.5	1,100	1.5	0.6
3025-075	2.5	7.5	23,400	220	1.875	1,070	1.875	1,550	1.875	0.75
3030-090	3	9	20,200	225	2.25	1,100	2.25	1,600	2.25	0.9
3030-150		15	15,200	150	2.25	800	2.25	1,100	2.25	0.9
3035-105	3.5	10.5	17,300	270	2.625	1,100	2.625	1,600	2.625	1.05
3040-120	4	12	15,200	300	3	1,100	3	1,600	3	1.2
3040-200		20	11,400	200	3	800	3	1,100	3	1.2
3045-135	4.5	13.5	13,500	300	3.375	1,100	3.375	1,600	3.375	1.35
3050-150	5	15	12,200	300	3.75	1,100	3.75	1,600	3.75	1.5
3050-250		25	9,200	200	3.75	800	3.75	1,100	3.75	1.5
3060-180	6	18	10,100	300	4.5	1,100	4.5	1,600	4.5	1.8
3060-300		30	7,600	200	4.5	800	4.5	1,100	4.5	1.8
3070-210	7	21	8,700	250	5.25	1,100	5.25	1,600	5.25	2.1
3070-350		35	6,500	160	5.25	800	5.25	1,100	5.25	2.1
3080-240	8	24	12,000	250	6	1,800	6	2,400	6	2.4
3080-400		40	9,000	160	6	1,300	6	1,700	6	2.4
3090-270	9	27	6,700	250	6.75	1,100	6.75	1,600	6.75	2.7
3090-450		45	5,100	160	6.75	800	6.75	1,100	6.75	2.7
3100-300	10	30	9,600	250	7.5	1,800	7.5	2,400	7.5	3
3100-500		50	7,200	160	7.5	1,300	7.5	1,700	7.5	3
3110-330	11	33	5,500	250	8.25	1,100	8.25	1,600	8.25	3.3
3110-550		55	4,100	160	8.25	800	8.25	1,100	8.25	3.3
3120-360	12	36	8,000	250	9	1,800	9	2,400	9	3.6
3120-600		60	6,000	160	9	1,300	9	1,700	9	3.6
Milling Amount (mm)				$a_p=0.75D$		$a_p=0.75D$		$a_p=0.75D$ $a_e=0.3D$		

UDC Series

CBN Series

Square
Long Neck Square

Radius

Long Neck Radius

Taper Neck Radius

Ball / Long Shank Ball

Long Neck Ball

Taper Neck Ball

Taper

Spiral V Cutter

Drill

EURO Series

Technical Data

Milling Conditions for AZS / DLC-AZS

◆ Low speed & highly efficient milling conditions (Assumed maximum spindle speed: 10,000 min⁻¹ or below)

WORK MATERIAL			A5052							
Model Number	Outside Diameter (mm)	Effective Length (mm)	Spindle Speed (min ⁻¹)	Vertical		Slotting		Side Milling		
				Feed Rate (mm/min)	a_p (mm)	Feed Rate (mm/min)	a_p (mm)	Feed Rate (mm/min)	a_p (mm)	a_e (mm)
3010-030	1	3	10,000	50	0.3	400	0.3	900	1	0.15
3015-045	1.5	4.5	10,000	80	0.45	600	0.45	1,250	1.5	0.225
3020-060	2	6	10,000	100	0.6	800	0.6	1,600	2	0.3
3025-075	2.5	7.5	10,000	130	0.75	1,000	0.75	2,050	2.5	0.375
3030-090	3	9	10,000	150	0.9	1,200	0.9	2,500	3	0.45
3035-105	3.5	10.5	10,000	180	1.05	1,400	1.05	2,600	3.5	0.525
3040-120	4	12	10,000	200	1.2	1,600	1.2	2,700	4	0.6
3045-135	4.5	13.5	10,000	230	1.35	1,800	1.35	3,050	4.5	0.675
3050-150	5	15	10,000	250	1.5	2,000	1.5	3,400	5	0.75
3060-180	6	18	10,000	300	1.8	2,400	1.8	4,000	6	0.9
3070-210	7	21	8,600	300	2.1	2,400	2.1	4,000	7	1.05
3080-240	8	24	8,100	300	2.4	3,000	2.4	4,800	8	1.2
3090-270	9	27	6,700	275	2.7	2,400	2.7	4,000	9	1.35
3100-300	10	30	6,480	250	3	3,000	3	4,800	10	1.5
3110-330	11	33	5,500	225	3.3	2,400	3.3	4,000	11	1.65
3120-360	12	36	5,400	200	3.6	3,000	3.6	4,800	12	1.8
Milling Amount (mm)				$a_p=0.3D$		$a_p=0.3D$		$a_p=1.0D$ $a_e=0.15D$		

UDC Series

CBN Series

Square

Long Neck Square

Radius

Long Neck Radius

Taper Neck Radius

Ball / Long Shank Ball

Long Neck Ball

Taper Neck Ball

Taper

Spiral V Cutter

Drill

EURO Series

Technical Data

Milling Conditions for AZS / DLC-AZS

3 Flutes

WORK MATERIAL			A7075							
Model Number	Outside Diameter (mm)	Effective Length (mm)	Spindle Speed (min ⁻¹)	Vertical		Slotting		Side Milling		
				Feed Rate (mm/min)	a_p (mm)	Feed Rate (mm/min)	a_p (mm)	Feed Rate (mm/min)	a_p (mm)	a_e (mm)
3010-030	1	3	10,000	50	0.3	400	0.3	750	1	0.15
3015-045	1.5	4.5	10,000	80	0.45	600	0.45	1,130	1.5	0.225
3020-060	2	6	10,000	100	0.6	800	0.6	1,500	2	0.3
3025-075	2.5	7.5	10,000	130	0.75	1,000	0.75	1,880	2.5	0.375
3030-090	3	9	10,000	150	0.9	1,200	0.9	2,250	3	0.45
3035-105	3.5	10.5	10,000	180	1.05	1,400	1.05	2,380	3.5	0.525
3040-120	4	12	10,000	200	1.2	1,600	1.2	2,500	4	0.6
3045-135	4.5	13.5	10,000	230	1.35	1,800	1.35	2,750	4.5	0.675
3050-150	5	15	9,600	250	1.5	2,000	1.5	3,000	5	0.75
3060-180	6	18	8,000	250	1.8	2,000	1.8	3,000	6	0.9
3070-210	7	21	6,900	200	2.1	2,000	2.1	3,000	7	1.05
3080-240	8	24	10,000	200	2.4	2,400	2.4	4,100	8	1.2
3090-270	9	27	5,300	200	2.7	2,000	2.7	3,000	9	1.35
3100-300	10	30	8,100	200	3	2,400	3	4,200	10	1.5
3110-330	11	33	4,400	200	3.3	2,000	3.3	3,000	11	1.65
3120-360	12	36	6,800	200	3.6	2,400	3.6	4,200	12	1.8
Milling Amount (mm)				$a_p=0.3D$		$a_p=0.3D$		$a_p=1.0D$ $a_e=0.15D$		

- Note:
- Recommend using a non-contact measuring device to avoid damaging the sharp bottom corner.
 - Decrease both spindle speed and feed rate proportionally in case of chattering.
 - These milling parameters are calculated based on the shortest overhang length. Longer overhangs may require an adjustment to the milling parameters.
 - Reduce the milling amount and feed rate in accordance with required milling precision.
 - Spindle rigidity should be considered when setting milling parameters, especially for Z-Axis drilling.
 - When slotting, using Z-Axis drilling, the milling parameters should promote good chip evacuation.
 - Reduce the milling amount when chips clog on the tool during Z-Axis drilling.
 - Set axial depth (a_p) to 1/3 ($a_p=0.25D$) in the area closest to a vertical wall with more than 2D work depth.
 - These are milling parameters under the work material is firmly fixed. Decrease spindle speed and feed rate according to the condition.
 - Recommend water soluble coolant.

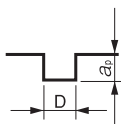

a_p : Axial Depth (mm)
D : Outside Diameter (mm)

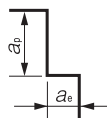

a_p : Axial Depth (mm)
 a_e : Radial Depth (mm)

- UDC Series
- CBN Series
- Square
- Long Neck Square
- Radius
- Long Neck Radius
- Taper Neck Radius
- Ball / Long Shank Ball
- Long Neck Ball
- Taper Neck Ball
- Taper
- Spiral V Cutter
- Drill
- EURO Series
- Technical Data



Size $\phi 1 \sim \phi 6$

HLS4000



Material Applications (☆ Highly Recommended ○ Recommended ○ Suggested)

Work Material															
Carbon Steels S45C S55C	Alloy Steels SK / SCM SUS	Prehardened Steels NAK HPM	Hardened Steels			Cast Iron	Aluminum Alloys	Graphite	Copper	Plastics	Glass Filled Plastics	Titanium Alloys	Heat Resistant Alloys	Cemented Carbide	Hard Brittle (Non-Metallic) Materials
			~55HRC	~60HRC	~70HRC										
○	○	○	○	○	○				○			○	○		

Features

Feature1 : Variable pitch

$\theta_1 > \theta_2$: The unequal division reduces chattering and tip damage.

$\theta_1 + \theta_2 = 180^\circ$: Easy to measure diameter.

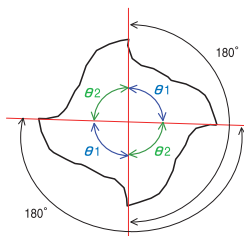

Feature2 : Back taper geometry

Back taper geometry reduces cutting force.

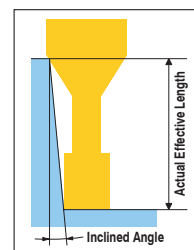
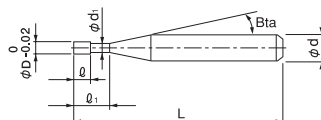
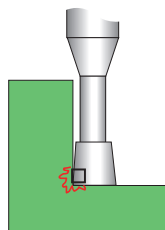

Feature3 : HARDMAX coating with high level of heat resistance, durability and lubrication.

Feature4 : Improved new 4 flute design offers improved chip evacuation and achieves high feed and milling precision.

The shank taper angle shown is not an exact value and to avoid contact with the work piece, we recommend the user controls the precise value of this angle. Shank taper angle should not make contact with the work piece.

Refer to page 230 for 2 flute HLS.

Total 84 models

Unit (mm)

Model Number	Outside Diameter ϕD	Effective Length ℓ_1	Length of Cut ℓ	Neck Diameter ϕd_1	Shank Taper Angle Bta	Overall Length L	Shank Diameter ϕd	Price ¥	Effective Length by Inclined Angles				
									30'	1°	1° 30'	2°	3°
									HLS 4010-040	1	4	1	0.95
HLS 4010-060	6	50	4,800	6.78	7.10	7.36	7.62	8.19					
HLS 4010-080	8	50	4,800	8.88	9.25	9.56	9.90	10.64					
HLS 4010-100	10	50	4,800	10.97	11.38	11.76	12.17	13.09					
HLS 4010-120	12	50	4,800	13.06	13.51	13.97	14.45	15.53					
HLS 4010-160	16	60	7,680	17.20	17.77	18.37	19.01	20.43					
HLS 4012-060	1.2	6	1.2	1.14	16°	50	4	4,800	6.18	6.38	6.60	6.83	7.34
HLS 4012-080		8				50		4,800	8.24	8.51	8.80	9.11	9.79
HLS 4012-100		10				50		4,800	10.31	10.64	11.00	11.38	12.24
HLS 4012-120		12				50		4,800	12.37	12.77	13.20	13.66	14.68
HLS 4012-160		16				50		6,720	16.49	17.03	17.60	18.22	19.58

Unit (mm)

Model Number	Outside Diameter ϕD	Effective Length ℓ_1	Length of Cut ℓ	Neck Diameter ϕd_1	Shank Taper Angle $B\alpha$	Overall Length L	Shank Diameter ϕd	Price ¥	Effective Length by Inclined Angles				
									30'	1°	1° 30'	2°	3°
HLS 4014-060	1.4	6	1.4	1.34	16°	50	4	4,800	6.18	6.38	6.60	6.83	7.34
HLS 4014-080		8				50	4	4,800	8.24	8.51	8.80	9.11	9.79
HLS 4014-100		10				50	4	4,800	10.31	10.64	11.00	11.38	12.24
HLS 4014-120		12				50	4	4,800	12.37	12.77	13.20	13.66	14.68
HLS 4014-140		14				60	4	4,800	14.43	14.90	15.40	15.94	17.13
HLS 4014-160		16				60	4	6,720	16.49	17.03	17.60	18.22	19.58
HLS 4014-220		22				60	4	8,640	22.68	23.42	24.21	25.05	No Interference
HLS 4015-060		1.5				6	1.5	1.44	16°	50	4	4,800	6.18
HLS 4015-080	8		50	4	4,800	8.24				8.51	8.80	9.11	9.79
HLS 4015-100	10		50	4	4,800	10.31				10.64	11.00	11.38	12.24
HLS 4015-120	12		50	4	4,800	12.37				12.77	13.20	13.66	14.68
HLS 4015-140	14		60	4	4,800	14.43				14.90	15.40	15.94	17.13
HLS 4015-160	16		60	4	4,800	16.49				17.03	17.60	18.22	19.58
HLS 4015-180	18		60	4	4,800	18.56				19.16	19.80	20.49	22.03
HLS 4015-200	20		60	4	4,800	20.62				21.29	22.00	22.77	No Interference
HLS 4016-060	1.6	6	1.6	1.51	16°	50	4	4,800	6.22	6.42	6.64	6.87	7.39
HLS 4016-080		8				50	4	4,800	8.28	8.55	8.84	9.15	9.83
HLS 4016-100		10				50	4	4,800	10.34	10.68	11.04	11.42	12.28
HLS 4016-120		12				50	4	4,800	12.40	12.81	13.24	13.70	14.73
HLS 4016-140		14				60	4	4,800	14.47	14.94	15.44	15.98	17.17
HLS 4016-160		16				60	4	4,800	16.53	17.07	17.64	18.26	19.62
HLS 4016-180		18				60	4	4,800	18.59	19.20	19.84	20.53	22.07
HLS 4016-200		20				60	4	4,800	20.66	21.33	22.04	22.81	No Interference
HLS 4016-260	26	60	4	11,040	26.84	27.72	28.65	29.64	No Interference				
HLS 4018-060	1.8	6	1.8	1.71	16°	50	4	4,800	6.22	6.42	6.64	6.87	7.39
HLS 4018-080		8				50	4	4,800	8.28	8.55	8.84	9.15	9.83
HLS 4018-100		10				50	4	4,800	10.34	10.68	11.04	11.42	12.28
HLS 4018-120		12				50	4	4,800	12.40	12.81	13.24	13.70	14.73
HLS 4018-140		14				60	4	4,800	14.47	14.94	15.44	15.98	17.17
HLS 4018-160		16				60	4	4,800	16.53	17.07	17.64	18.26	19.62
HLS 4018-180		18				60	4	4,800	18.59	19.20	19.84	20.53	No Interference
HLS 4018-200		20				60	4	4,800	20.66	21.33	22.04	22.81	No Interference
HLS 4018-250	25	70	4	6,720	25.81	26.65	27.55	28.50	No Interference				
HLS 4020-060	2	6	2	1.91	16°	50	4	4,800	6.22	6.42	6.64	6.87	7.39
HLS 4020-080		8				50	4	4,800	8.28	8.55	8.84	9.15	9.83
HLS 4020-100		10				50	4	4,800	10.34	10.68	11.04	11.42	12.28
HLS 4020-120		12				50	4	4,800	12.40	12.81	13.24	13.70	14.73
HLS 4020-140		14				60	4	4,800	14.47	14.94	15.44	15.98	17.17
HLS 4020-160		16				60	4	4,800	16.53	17.07	17.64	18.26	No Interference
HLS 4020-180		18				60	4	4,800	18.59	19.20	19.84	20.53	No Interference
HLS 4020-200		20				60	4	4,800	20.66	21.33	22.04	22.81	No Interference
HLS 4020-250		25				70	4	5,280	25.81	26.65	27.55	28.50	No Interference
HLS 4020-300		30				70	4	6,720	30.97	31.97	33.05	No Interference	No Interference

4 Flutes

UDC Series

CBN Series

Square

Long Neck Square

Radius

Long Neck Radius

Taper Neck Radius

Ball / Long Shank Ball

Long Neck Ball

Taper Neck Ball

Taper

Spiral V Cutter

Drill

EURO Series

Technical Data

Next Page ➡

277

Unit (mm)

Model Number	Outside Diameter ϕD	Effective Length ℓ_1	Length of Cut ℓ	Neck Diameter ϕd_1	Shank Taper Angle Bta	Overall Length L	Shank Diameter ϕd	Price ¥	Effective Length by Inclined Angles								
									30'	1°	1° 30'	2°	3°				
HLS 4025-080	2.5	8	2.5	2.41	16°	50	4	4,800	8.28	8.55	8.84	9.15	9.83				
HLS 4025-120		12				50	4	4,800	12.40	12.81	13.24	13.70	No Interference				
HLS 4025-160		16				60	4	4,800	16.53	17.07	17.64	18.26	No Interference				
HLS 4025-200		20				60	4	4,800	20.66	21.33	22.04	No Interference	No Interference				
HLS 4025-250		25				70	4	4,800	25.81	26.65	27.55	No Interference	No Interference				
HLS 4025-300		30				70	4	5,280	30.97	31.97	No Interference	No Interference	No Interference				
HLS 4030-080	3	8	3	2.92	16°	50	6	6,720	8.28	8.55	8.84	9.15	9.83				
HLS 4030-120		12				50	6	6,720	12.40	12.81	13.24	13.70	14.73				
HLS 4030-160		16				60	6	6,720	16.53	17.07	17.64	18.26	19.62				
HLS 4030-200		20				60	6	6,720	20.66	21.33	22.04	22.81	24.52				
HLS 4030-250		25				70	6	6,720	25.81	26.65	27.55	28.50	No Interference				
HLS 4030-300		30				70	6	8,640	30.97	31.97	33.05	34.20	No Interference				
HLS 4030-400	40	80	6	8,640	41.28	42.62	44.05	No Interference	No Interference								
HLS 4040-120	4	12	4	3.82	16°	50	6	7,560	12.58	12.99	13.43	13.90	14.94				
HLS 4040-160		16				60	6	7,560	16.71	17.25	17.83	18.45	No Interference				
HLS 4040-200		20				60	6	7,560	20.84	21.51	22.24	23.01	No Interference				
HLS 4040-250		25				70	6	7,560	25.99	26.84	27.74	28.70	No Interference				
HLS 4040-300		30				70	6	7,560	31.15	32.16	33.24	No Interference	No Interference				
HLS 4040-350		35				80	6	7,560	36.31	37.48	No Interference	No Interference	No Interference				
HLS 4040-400	40	90	6	9,600	41.46	42.81	No Interference	No Interference	No Interference								
HLS 4040-450	45	90	6	11,520	46.62	48.13	No Interference	No Interference	No Interference								
HLS 4040-500	50	100	6	14,520	51.78	53.46	No Interference	No Interference	No Interference								
HLS 4050-160	5	16	5	4.82	16°	60	6	9,600	16.78	17.25	18.02	No Interference	No Interference				
HLS 4050-250		25				70	6	9,600	25.99	26.84	No Interference	No Interference	No Interference				
HLS 4050-350		35				80	6	9,600	36.31	No Interference	No Interference	No Interference	No Interference				
HLS 4050-500		50				110	6	14,520	51.78	No Interference	No Interference	No Interference	No Interference				
HLS 4060-200		6				20	6	5.82	—	80	6	9,600	No Interference	No Interference	No Interference	No Interference	No Interference
HLS 4060-300						30				90	6	9,600	No Interference	No Interference	No Interference	No Interference	No Interference
HLS 4060-400	40		100	6	11,520	No Interference				No Interference	No Interference	No Interference	No Interference				
HLS 4060-500	50		110	6	14,520	No Interference				No Interference	No Interference	No Interference	No Interference				

- UDC Series
- CBN Series
- Square
- Long Neck Square
- Radius
- Long Neck Radius
- Taper Neck Radius
- Ball / Long Shank Ball
- Long Neck Ball
- Taper Neck Ball
- Taper
- Spiral V Cutter
- Drill
- EURO Series
- Technical Data

Circle Pocket Milling Example

SKD11 (60HRC)

Tool: HLS $\phi 1.5 \times$ Effective Length 10 mm

Spindle Speed	7,000 min ⁻¹
Feed Rate	230 mm/min
Axial Depth a_p	0.025 mm
Radial Depth a_e	1.2 mm
Coolant	Air blow (Nozzle)
Overhang Length	18 mm
Pocket Size	$\phi 7 \times 2$ mm
Cycle Time	17 min



SKD11 (60HRC)

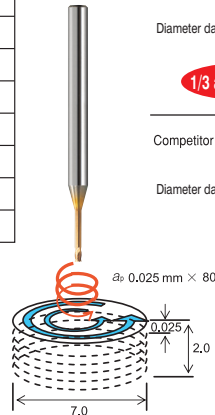

HLS 4 Flutes $\phi 1.5 \times 10$

Diameter damage: 0.091 mm

1/3 and under!

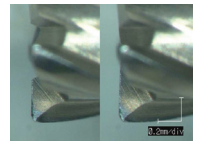

Competitor: 4 Flutes $\phi 1.5 \times 10$

Diameter damage: 0.296 mm

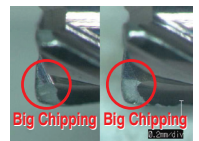
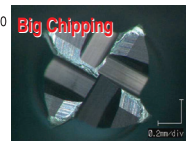

Milling Conditions for HLS (4 Flutes)

WORK MATERIAL		CARBON STEELS S45C / S50C (~225HB)					ALLOY STEELS SK / SCM / SUS (225~325HB)				PREHARDENED STEELS HARDENED STEELS NAK / SKD (30~45HRC)				HARDENED STEELS SKD / SKT / STAVAX (45~55HRC)				HARDENED STEELS SKD / SKH (55~60HRC)			
Model Number	Outside Diameter (mm)	Effective Length (mm)	Spindle Speed (min ⁻¹)	Feed Rate (mm/min)	a _p Axial Depth (mm)	a _e Radial Depth (mm)	Spindle Speed (min ⁻¹)	Feed Rate (mm/min)	a _p Axial Depth (mm)	a _e Radial Depth (mm)	Spindle Speed (min ⁻¹)	Feed Rate (mm/min)	a _p Axial Depth (mm)	a _e Radial Depth (mm)	Spindle Speed (min ⁻¹)	Feed Rate (mm/min)	a _p Axial Depth (mm)	a _e Radial Depth (mm)	Spindle Speed (min ⁻¹)	Feed Rate (mm/min)	a _p Axial Depth (mm)	a _e Radial Depth (mm)
4010	1	4	24,700	1,180	0.04	0.351	21,000	950	0.036	0.332	21,500	660	0.028	0.312	17,200	470	0.02	0.293	10,100	240	0.01	0.195
		6	22,800	1,060	0.024	0.104	19,400	840	0.021	0.099	16,400	590	0.016	0.093	13,100	420	0.012	0.087	9,400	210	0.007	0.058
		8	20,900	950	0.021	0.043	17,800	740	0.018	0.041	14,600	500	0.014	0.038	11,700	360	0.01	0.036	8,700	190	0.006	0.024
		10	19,100	840	0.018	0.023	16,200	630	0.015	0.022	13,000	450	0.013	0.021	10,400	320	0.009	0.02	8,100	160	0.005	0.013
		12	17,300	730	0.015	0.013	14,700	530	0.013	0.012	11,300	380	0.011	0.011	9,000	270	0.008	0.011	7,400	130	0.004	0.007
		16	13,500	500	0.009	0.005	11,500	320	0.008	0.005	11,000	220	0.007	0.005	8,800	160	0.005	0.005	6,000	80	0.003	0.003
4012	1.2	6	21,400	1,290	0.04	0.216	18,200	1,020	0.034	0.204	15,400	710	0.027	0.192	12,300	510	0.019	0.18	8,900	260	0.011	0.12
		8	19,700	1,160	0.035	0.092	16,700	890	0.03	0.087	13,800	620	0.024	0.082	11,000	440	0.017	0.077	8,200	230	0.01	0.051
		10	17,900	1,020	0.03	0.047	15,200	770	0.026	0.044	12,100	530	0.021	0.042	9,700	380	0.015	0.039	7,600	200	0.009	0.026
		12	16,200	880	0.025	0.027	13,800	640	0.021	0.026	10,500	450	0.018	0.024	8,400	320	0.013	0.023	6,900	160	0.007	0.015
		16	12,600	610	0.015	0.011	10,700	330	0.013	0.01	9,900	270	0.007	0.01	7,900	190	0.005	0.009	5,600	100	0.005	0.006
4014	1.4	6	20,200	1,440	0.068	0.4	17,200	1,140	0.058	0.377	14,500	800	0.046	0.355	11,600	570	0.033	0.333	8,400	290	0.019	0.222
		8	19,000	1,290	0.06	0.169	16,200	900	0.051	0.16	13,000	690	0.041	0.15	10,400	490	0.029	0.141	7,800	260	0.017	0.094
		10	17,000	1,140	0.051	0.086	14,500	860	0.043	0.082	11,500	600	0.036	0.077	9,200	430	0.026	0.072	7,100	220	0.014	0.048
		12	15,300	990	0.043	0.05	13,000	710	0.036	0.048	10,000	500	0.03	0.045	8,000	360	0.022	0.042	6,500	180	0.012	0.028
		14	13,700	840	0.034	0.032	11,600	570	0.029	0.031	9,800	410	0.025	0.029	7,800	290	0.018	0.027	5,900	140	0.01	0.018
		16	11,900	680	0.026	0.022	10,100	350	0.022	0.02	9,100	310	0.02	0.019	7,300	220	0.014	0.018	5,300	110	0.008	0.012
4015	1.5	22	9,000	340	0.013	0.009	6,000	230	0.011	0.009	7,800	170	0.01	0.008	6,200	120	0.007	0.008	3,500	50	0.001	0.005
		6	19,800	1,520	0.08	0.527	16,800	1,200	0.068	0.498	14,300	840	0.054	0.469	11,400	600	0.039	0.44	8,200	310	0.022	0.293
		8	18,200	1,360	0.07	0.223	15,500	930	0.06	0.211	12,800	730	0.048	0.198	10,200	520	0.034	0.186	7,600	270	0.02	0.124
		10	16,600	1,200	0.06	0.113	14,100	900	0.051	0.107	11,300	630	0.042	0.101	9,000	450	0.03	0.095	7,000	230	0.017	0.063
		12	15,000	1,040	0.05	0.067	12,800	720	0.043	0.063	9,800	530	0.036	0.059	7,800	380	0.026	0.056	6,400	190	0.014	0.037
		14	13,400	880	0.04	0.041	11,400	600	0.034	0.039	9,500	420	0.03	0.037	7,600	300	0.021	0.035	5,800	150	0.012	0.023
		16	11,700	720	0.03	0.027	9,900	370	0.026	0.026	8,900	320	0.024	0.024	7,100	230	0.017	0.023	5,200	120	0.009	0.015
4016	1.6	18	10,100	560	0.02	0.02	9,600	310	0.017	0.019	8,400	240	0.017	0.018	6,700	170	0.012	0.017	4,600	80	0.007	0.011
		20	8,500	400	0.01	0.014	9,000	280	0.011	0.014	7,900	210	0.011	0.013	6,300	150	0.008	0.012	4,000	40	0.004	0.008
		6	19,200	1,670	0.08	0.682	15,100	1,320	0.068	0.644	13,900	920	0.054	0.606	11,100	660	0.039	0.569	8,000	340	0.022	0.379
		8	17,000	1,500	0.07	0.288	15,000	950	0.06	0.272	12,400	800	0.048	0.256	9,900	570	0.034	0.24	7,400	300	0.02	0.16
		10	16,100	1,320	0.06	0.148	12,700	930	0.051	0.139	10,900	700	0.042	0.131	8,700	500	0.03	0.123	6,800	250	0.017	0.082
		12	14,500	1,140	0.05	0.085	11,500	750	0.043	0.08	9,500	590	0.036	0.075	7,600	420	0.026	0.071	6,200	210	0.014	0.047
		14	13,000	970	0.04	0.054	10,300	660	0.034	0.051	9,100	460	0.03	0.048	7,300	330	0.021	0.045	5,600	170	0.012	0.03
		16	11,400	790	0.03	0.036	9,500	380	0.02	0.034	8,500	350	0.024	0.032	6,800	250	0.017	0.03	5,000	130	0.009	0.02
		18	9,800	620	0.02	0.025	9,300	340	0.017	0.024	8,000	250	0.017	0.022	6,400	180	0.012	0.021	4,500	80	0.007	0.014
4018	1.8	20	8,200	440	0.011	0.018	8,700	300	0.011	0.017	7,600	220	0.011	0.016	6,100	160	0.008	0.015	3,900	40	0.004	0.01
		26	8,000	300	0.007	0.009	7,400	210	0.006	0.009	6,600	170	0.006	0.008	5,300	120	0.004	0.008	2,400	20	0.002	0.005
		6	18,500	1,820	0.08	1.094	14,900	1,440	0.068	1.034	13,300	1,010	0.054	0.973	10,600	720	0.039	0.912	7,600	370	0.022	0.608
		8	16,900	1,630	0.07	0.461	14,600	980	0.06	0.435	11,900	870	0.048	0.41	9,500	620	0.034	0.384	7,100	320	0.02	0.256
		10	15,400	1,440	0.06	0.236	12,500	950	0.051	0.223	10,500	760	0.042	0.21	8,400	540	0.03	0.197	6,500	280	0.017	0.131
		12	13,900	1,250	0.05	0.137	11,000	770	0.043	0.129	9,100	640	0.036	0.122	7,300	460	0.026	0.114	6,000	230	0.014	0.076
		14	12,400	1,060	0.04	0.086	9,500	720	0.034	0.082	8,400	500	0.03	0.077	6,700	360	0.021	0.072	5,400	180	0.012	0.048
		16	10,900	860	0.03	0.058	9,000	450	0.026	0.054	7,900	390	0.024	0.051	6,300	280	0.017	0.048	4,800	140	0.009	0.032
		18	9,400	670	0.02	0.041	8,700	380	0.017	0.039	7,400	270	0.017	0.037	5,900	190	0.012	0.035	4,300	100	0.007	0.023
20	7,900	480	0.015	0.029	8,400	340	0.013	0.027	7,000	240	0.011	0.026	5,600	170	0.008	0.024	3,700	50	0.004	0.016		
25	7,800	350	0.01	0.014	7,300	260	0.008	0.014	6,300	200	0.007	0.013	5,000	140	0.005	0.012	2,400	20	0.002	0.008		

4 Flutes

UDC Series

CBN Series

Square
Long Neck Square

Radius

Long Neck Radius

Taper Neck Radius

Ball / Long Shank Ball

Long Neck Ball

Taper Neck Ball

Taper

Spiral V Cutter

Drill

EURO Series

Technical Data

Milling Conditions for HLS (4 Flutes)

WORK MATERIAL			CARBON STEELS S45C / S50C (~225HB)				ALLOY STEELS SK / SCM / SUS (225~325HB)				PREHARDENED STEELS HARDENED STEELS NAK / SKD (30~45HRC)				HARDENED STEELS SKD / SKT / STAVAX (45~55HRC)				HARDENED STEELS SKD / SKH (55~60HRC)				
Model Number	Outside Diameter (mm)	Effective Length (mm)	Spindle Speed (min ⁻¹)	Feed Rate (mm/min)	a _p Axial Depth (mm)	a _e Radial Depth (mm)	Spindle Speed (min ⁻¹)	Feed Rate (mm/min)	a _p Axial Depth (mm)	a _e Radial Depth (mm)	Spindle Speed (min ⁻¹)	Feed Rate (mm/min)	a _p Axial Depth (mm)	a _e Radial Depth (mm)	Spindle Speed (min ⁻¹)	Feed Rate (mm/min)	a _p Axial Depth (mm)	a _e Radial Depth (mm)	Spindle Speed (min ⁻¹)	Feed Rate (mm/min)	a _p Axial Depth (mm)	a _e Radial Depth (mm)	
UDC Series	4020	2	6	17,900	1,980	0.08	1.667	14,500	1,560	0.068	1.574	12,900	1,090	0.054	1.482	10,300	780	0.039	1.389	7,400	400	0.022	0.926
			8	16,400	1,770	0.07	0.704	14,200	1,000	0.06	0.665	11,500	950	0.048	0.626	9,200	680	0.034	0.587	6,800	350	0.02	0.391
			10	14,900	1,560	0.06	0.36	12,000	980	0.051	0.34	10,100	830	0.042	0.32	8,100	590	0.03	0.3	6,300	300	0.017	0.2
			12	13,500	1,350	0.05	0.209	10,500	790	0.043	0.197	8,800	690	0.036	0.186	7,000	490	0.026	0.174	5,800	250	0.014	0.116
			14	12,000	1,140	0.04	0.131	9,400	780	0.034	0.124	8,300	550	0.03	0.117	6,600	390	0.021	0.11	5,200	200	0.012	0.073
			16	10,600	940	0.03	0.088	9,000	500	0.026	0.083	7,600	420	0.024	0.078	6,100	300	0.017	0.074	4,700	160	0.009	0.049
			18	9,100	730	0.022	0.061	8,700	420	0.02	0.058	7,300	290	0.017	0.054	5,800	210	0.012	0.051	4,100	100	0.007	0.034
			20	7,700	520	0.018	0.045	8,100	380	0.016	0.043	6,900	270	0.013	0.04	5,500	190	0.009	0.038	3,600	50	0.004	0.025
			25	7,500	390	0.012	0.023	7,100	290	0.011	0.022	6,100	220	0.008	0.021	4,900	160	0.006	0.02	2,400	20	0.002	0.013
			30	7,000	310	0.008	0.013	6,300	230	0.007	0.012	5,600	180	0.006	0.011	4,500	130	0.004	0.011	2,400	10	0.001	0.007
CBN Series	4020	2	6	17,900	1,980	0.08	1.667	14,500	1,560	0.068	1.574	12,900	1,090	0.054	1.482	10,300	780	0.039	1.389	7,400	400	0.022	0.926
			8	16,400	1,770	0.07	0.704	14,200	1,000	0.06	0.665	11,500	950	0.048	0.626	9,200	680	0.034	0.587	6,800	350	0.02	0.391
			10	14,900	1,560	0.06	0.36	12,000	980	0.051	0.34	10,100	830	0.042	0.32	8,100	590	0.03	0.3	6,300	300	0.017	0.2
			12	13,500	1,350	0.05	0.209	10,500	790	0.043	0.197	8,800	690	0.036	0.186	7,000	490	0.026	0.174	5,800	250	0.014	0.116
			14	12,000	1,140	0.04	0.131	9,400	780	0.034	0.124	8,300	550	0.03	0.117	6,600	390	0.021	0.11	5,200	200	0.012	0.073
			16	10,600	940	0.03	0.088	9,000	500	0.026	0.083	7,600	420	0.024	0.078	6,100	300	0.017	0.074	4,700	160	0.009	0.049
Square	4020	2	6	17,900	1,980	0.08	1.667	14,500	1,560	0.068	1.574	12,900	1,090	0.054	1.482	10,300	780	0.039	1.389	7,400	400	0.022	0.926
			8	16,400	1,770	0.07	0.704	14,200	1,000	0.06	0.665	11,500	950	0.048	0.626	9,200	680	0.034	0.587	6,800	350	0.02	0.391
			10	14,900	1,560	0.06	0.36	12,000	980	0.051	0.34	10,100	830	0.042	0.32	8,100	590	0.03	0.3	6,300	300	0.017	0.2
			12	13,500	1,350	0.05	0.209	10,500	790	0.043	0.197	8,800	690	0.036	0.186	7,000	490	0.026	0.174	5,800	250	0.014	0.116
			14	12,000	1,140	0.04	0.131	9,400	780	0.034	0.124	8,300	550	0.03	0.117	6,600	390	0.021	0.11	5,200	200	0.012	0.073
			16	10,600	940	0.03	0.088	9,000	500	0.026	0.083	7,600	420	0.024	0.078	6,100	300	0.017	0.074	4,700	160	0.009	0.049
Long Neck Square	4020	2	6	17,900	1,980	0.08	1.667	14,500	1,560	0.068	1.574	12,900	1,090	0.054	1.482	10,300	780	0.039	1.389	7,400	400	0.022	0.926
			8	16,400	1,770	0.07	0.704	14,200	1,000	0.06	0.665	11,500	950	0.048	0.626	9,200	680	0.034	0.587	6,800	350	0.02	0.391
			10	14,900	1,560	0.06	0.36	12,000	980	0.051	0.34	10,100	830	0.042	0.32	8,100	590	0.03	0.3	6,300	300	0.017	0.2
			12	13,500	1,350	0.05	0.209	10,500	790	0.043	0.197	8,800	690	0.036	0.186	7,000	490	0.026	0.174	5,800	250	0.014	0.116
			14	12,000	1,140	0.04	0.131	9,400	780	0.034	0.124	8,300	550	0.03	0.117	6,600	390	0.021	0.11	5,200	200	0.012	0.073
			16	10,600	940	0.03	0.088	9,000	500	0.026	0.083	7,600	420	0.024	0.078	6,100	300	0.017	0.074	4,700	160	0.009	0.049
Radius	4025	2.5	8				12,800	1,020	0.081	1.622	9,600	980	0.055	1.526	7,700	700	0.039	1.431	6,200	370	0.023	0.954	
			12				10,000	810	0.056	0.481	7,900	700	0.042	0.453	6,300	500	0.03	0.425	5,600	350	0.018	0.283	
			16				8,400	590	0.04	0.202	6,900	450	0.031	0.19	5,500	320	0.022	0.179	4,400	320	0.013	0.119	
			20				7,300	490	0.03	0.104	6,500	420	0.024	0.098	5,200	300	0.017	0.092	3,500	290	0.01	0.061	
			25				6,400	390	0.019	0.053	6,000	380	0.015	0.05	4,800	270	0.011	0.047	2,400	250	0.005	0.031	
			30				5,700	320	0.012	0.031	4,400	350	0.01	0.029	3,500	250	0.007	0.027	2,300	220	0.003	0.018	
Long Neck Radius	4025	2.5	8				12,800	1,020	0.081	1.622	9,600	980	0.055	1.526	7,700	700	0.039	1.431	6,200	370	0.023	0.954	
			12				10,000	810	0.056	0.481	7,900	700	0.042	0.453	6,300	500	0.03	0.425	5,600	350	0.018	0.283	
			16				8,400	590	0.04	0.202	6,900	450	0.031	0.19	5,500	320	0.022	0.179	4,400	320	0.013	0.119	
			20				7,300	490	0.03	0.104	6,500	420	0.024	0.098	5,200	300	0.017	0.092	3,500	290	0.01	0.061	
			25				6,400	390	0.019	0.053	6,000	380	0.015	0.05	4,800	270	0.011	0.047	2,400	250	0.005	0.031	
			30				5,700	320	0.012	0.031	4,400	350	0.01	0.029	3,500	250	0.007	0.027	2,300	220	0.003	0.018	
Taper Neck Radius	4030	3	8				10,900	1,080	0.093	2.361	7,400	1,010	0.073	2.222	5,900	720	0.052	2.084	5,900	440	0.031	1.389	
			12				8,700	830	0.073	0.996	7,000	730	0.057	0.938	5,600	520	0.041	0.879	5,000	400	0.024	0.586	
			16				7,400	670	0.058	0.42	6,000	520	0.045	0.395	5,300	370	0.032	0.371	4,000	370	0.019	0.247	
			20				6,600	560	0.045	0.216	6,100	490	0.035	0.203	4,900	350	0.025	0.191	3,400	340	0.015	0.127	
			25				5,800	460	0.032	0.111	5,600	450	0.025	0.14	4,500	320	0.018	0.098	2,400	290	0.011	0.065	
			30				5,200	390	0.023	0.065	4,300	410	0.02	0.061	3,400	290	0.014	0.057	2,300	250	0.009	0.038	
Ball / Long Shank Ball	4030	3	8				10,900	1,080	0.093	2.361	7,400	1,010	0.073	2.222	5,900	720	0.052	2.084	5,900	440	0.031	1.389	
			12				8,700	830	0.073	0.996	7,000	730	0.057	0.938	5,600	520	0.041	0.879	5,000	400	0.024	0.586	
			16				7,400	670	0.058	0.42	6,000	520	0.045	0.395	5,300	370	0.032	0.371	4,000	370	0.019	0.247	
			20				6,600	560	0.045	0.216	6,100	490	0.035	0.203	4,900	350	0.025	0.191	3,400	340	0.015	0.127	
			25				5,800	460	0.032	0.111	5,600	450	0.025	0.14	4,500	320	0.018	0.098	2,400	290	0.011	0.065	
			30				5,200	390	0.023	0.065	4,300	410	0.02	0.061	3,400	290	0.014	0.057	2,300	250	0.009	0.038	
Long Neck Ball	4030	3	8				10,900	1,080	0.093	2.361	7,400	1,010	0.073	2.222	5,900	720	0.052	2.084	5,900	440	0.031	1.389	
			12				8,700	830	0.073	0.996	7,000	730	0.057	0.938									

Milling Conditions for HLS (4 Flutes)

Slotting

a_p : Axial Depth (mm)
 D : Outside Diameter (mm)

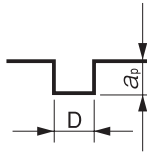

Side Milling

a_p : Axial Depth (mm)
 a_e : Radial Depth (mm)

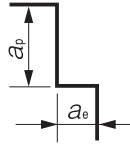

Note:

- Recommend using a non-contact measuring device to avoid damaging the precision tip point.
- Decrease both spindle speed and feed rate proportionally when the milling parameters exceed the machine's maximum spindle speed.
- Every coolant offers stable milling.
- Recommend oil coolant for Stainless Steels and Heat Resistant Alloys.
- Recommend wet coolant for Copper.

4 Flutes

UDC Series

CBN Series

Square

Square

Long Neck Square

Radius

Radius

Long Neck Radius

Taper Neck Radius

Ball / Long Shank Ball

Ball

Long Neck Ball

Taper Neck Ball

Taper

Taper

Spiral V Cutter

Drill

EURO Series

Technical Data



Size $\phi 1 \sim \phi 12$

CXS



Material Applications (☆ Highly Recommended ○ Recommended ○ Suggested)

Work Material															
Carbon Steels	Alloy Steels	Prehardened Steels	Hardened Steels			Cast Iron	Aluminum Alloys	Graphite	Copper	Plastics	Glass Filled Plastics	Titanium Alloys	Heat Resistant Alloys	Cemented Carbide	Hard Brittle (Non-Metallic) Materials
S45C S55C	SK / SCM SUS	NAK HPM	~55HRC	~60HRC	~70HRC										
○	○	○	○			○			○				○	○	

Features

Variable Pitch & Helix design minimizes vibration and chattering.
 Selected high toughness and chip resistant carbide material.
 Optimized flute design offers outstanding high efficiency milling and fine finishing.
 Low friction coating resulting in excellent chip evacuation and resistance to wear.

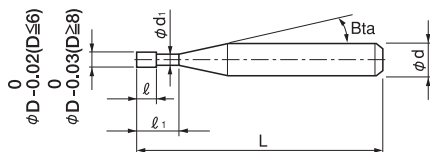

The shank taper angle shown is not an exact value and to avoid contact with the work piece, we recommend the user controls the precise value of this angle. Shank taper angle should not make contact with the work piece.

Total 33 models

Unit (mm)

Model Number	Outside Diameter ϕD	Effective Length ℓ_1	Length of Cut ℓ	Neck Diameter ϕd_1	Shank Taper Angle B_{ta}	Overall Length L	Shank Diameter ϕd	Price ¥	Effective Length by Inclined Angles				
									30'	1°	1°30'	2°	3°
CXS 4010-030	1	3	1.5	0.96	16°	50	4	6,520	3.25	3.35	3.47	3.59	3.86
CXS 4010-050		5				70	4	6,920	5.31	5.48	5.67	5.87	6.31
CXS 4010-060		6				70	4	7,110	6.34	6.55	6.77	7.00	7.53
CXS 4015-045	1.5	4.5	2.25	1.46	16°	50	4	6,520	4.66	4.81	4.97	5.15	5.53
CXS 4015-070		7				70	4	6,920	7.23	7.47	7.72	7.99	8.59
CXS 4015-085		8.5				70	4	7,110	8.78	9.07	9.37	9.70	10.43
CXS 4020-060	2	6	3	1.94	16°	50	4	6,100	6.24	6.44	6.66	6.89	7.41
CXS 4020-090		9				70	4	6,480	9.33	9.64	9.96	10.31	11.08
CXS 4020-110		11				70	4	6,650	11.40	11.77	12.16	12.59	13.53
CXS 4025-075	2.5	7.5	3.75	2.44	16°	50	4	6,100	7.79	8.04	8.31	8.60	9.25
CXS 4025-110		11				70	4	6,480	11.40	11.77	12.16	12.59	13.53
CXS 4025-135		13.5				70	4	6,650	13.97	14.43	14.91	15.43	No Interference

Unit (mm)

Model Number	Outside Diameter ϕD	Effective Length l_1	Length of Cut l	Neck Diameter ϕd_1	Shank Taper Angle β	Overall Length L	Shank Diameter ϕd	Price ¥	Effective Length by Inclined Angles				
									30°	1°	1°30'	2°	3°
CXS 4030-090	3	9	4.5	2.95	16°	50	6	7,000	9.34	9.64	9.97	10.31	11.09
CXS 4030-130		13				70	6	7,430	13.46	13.90	14.37	14.87	15.98
CXS 4030-160		16				70	6	7,630	16.56	17.10	17.67	18.28	19.65
CXS 4040-120	4	12	6	3.86	16°	50	6	7,350	12.61	13.02	13.46	13.92	14.97
CXS 4040-170		17				70	6	7,800	17.76	18.34	18.96	19.62	No Interference
CXS 4040-210		21				70	6	8,010	21.89	22.60	23.36	24.17	No Interference
CXS 4050-150	5	15	7.5	4.86	16°	50	6	7,900	15.70	16.21	16.76	No Interference	No Interference
CXS 4050-210		21				70	6	8,380	21.89	22.60	No Interference	No Interference	No Interference
CXS 4050-260		26				70	6	8,610	27.05	27.93	No Interference	No Interference	No Interference
CXS 4060-180	6	18	9	5.86	—	50	6	8,500	No Interference	No Interference	No Interference	No Interference	No Interference
CXS 4060-260		26				70	6	9,020	No Interference	No Interference	No Interference	No Interference	No Interference
CXS 4060-320		32				70	6	9,270	No Interference	No Interference	No Interference	No Interference	No Interference
CXS 4080-240	8	24	12	7.82	—	60	8	10,500	No Interference	No Interference	No Interference	No Interference	No Interference
CXS 4080-340		34				90	8	11,140	No Interference	No Interference	No Interference	No Interference	No Interference
CXS 4080-420		42				90	8	11,450	No Interference	No Interference	No Interference	No Interference	No Interference
CXS 4100-300	10	30	15	9.82	—	70	10	12,500	No Interference	No Interference	No Interference	No Interference	No Interference
CXS 4100-420		42				100	10	13,270	No Interference	No Interference	No Interference	No Interference	No Interference
CXS 4100-520		52				100	10	13,630	No Interference	No Interference	No Interference	No Interference	No Interference
CXS 4120-360	12	36	18	11.82	—	90	12	17,800	No Interference	No Interference	No Interference	No Interference	No Interference
CXS 4120-520		52				110	12	18,880	No Interference	No Interference	No Interference	No Interference	No Interference
CXS 4120-620		62				110	12	19,400	No Interference	No Interference	No Interference	No Interference	No Interference

4 Flutes

UDC Series

CBN Series

Square

Square

Long Neck Square

Radius

Radius

Long Neck Radius

Taper Neck Radius

Ball / Long Shank Ball

Ball

Long Neck Ball

Taper Neck Ball

Taper

Taper

Spiral V Cutter

Drill

EURO Series

Technical Data

Milling Conditions for CXS

Side Milling

WORK MATERIAL			CARBON STEELS S45C / S50C Annealed Materials (~225HB)				ALLOY STEELS SK / SCM Annealed Materials (225~325HB)				STAINLESS STEELS SUS304 Use water soluble or oil coolant.			
Model Number	Outside Diameter (mm)	Effective Length (mm)	Spindle Speed (min ⁻¹)	Feed Rate (mm/min)	a _p Axial Depth (mm)	a _e Radial Depth (mm)	Spindle Speed (min ⁻¹)	Feed Rate (mm/min)	a _p Axial Depth (mm)	a _e Radial Depth (mm)	Spindle Speed (min ⁻¹)	Feed Rate (mm/min)	a _p Axial Depth (mm)	a _e Radial Depth (mm)
UDC Series	1	3	18,000	780	1	0.3	18,000	600	1	0.3	14,500	400	1	0.3
		5	18,000	780	1	0.23	15,330	520	1	0.23	12,570	350	1	0.23
		6	18,000	780	1	0.2	14,000	480	1	0.2	11,600	320	1	0.2
CBN Series	1.5	4.5	13,500	970	1.5	0.45	13,500	750	1.5	0.45	13,300	420	1.5	0.45
		7	13,500	970	1.5	0.36	11,810	660	1.5	0.36	11,610	360	1.5	0.36
		8.5	13,500	970	1.5	0.3	10,800	600	1.5	0.3	10,600	330	1.5	0.3
Square	2	6	11,000	1,170	2	0.6	11,000	900	2	0.6	12,200	450	2	0.6
		9	11,000	1,170	2	0.48	9,680	790	2	0.48	10,730	400	2	0.48
		11	11,000	1,170	2	0.4	8,800	720	2	0.4	9,750	360	2	0.4
Long Neck Square	2.5	7.5	9,500	1,180	2.5	0.75	9,500	900	2.5	0.75	11,000	550	2.5	0.75
		11	9,500	1,180	2.5	0.6	8,390	800	2.5	0.6	9,720	490	2.5	0.6
		13.5	9,500	1,180	2.5	0.5	7,600	720	2.5	0.5	8,800	440	2.5	0.5
Radius	3	9	8,500	1,200	3	0.9	8,500	900	3	0.9	10,000	640	3	0.9
		13	8,500	1,200	3	0.73	7,530	800	3	0.73	8,860	570	3	0.73
		16	8,500	1,200	3	0.6	6,800	720	3	0.6	8,000	510	3	0.6
Long Neck Radius	4	12	7,200	1,350	4	1.2	6,700	1,000	4	1.2	7,500	730	4	1.2
		17	7,200	1,350	4	0.98	5,920	890	4	0.98	6,670	650	4	0.98
		21	7,200	1,350	4	0.8	5,300	800	4	0.8	6,000	580	4	0.8
Ball / Long Shark Ball	5	15	6,000	1,500	5	1.5	5,400	1,100	5	1.5	5,400	810	5	1.5
		21	6,000	1,500	5	1.23	4,800	980	5	1.23	4,800	720	5	1.23
		26	6,000	1,500	5	1	4,300	880	5	1	4,300	640	5	1
Long Neck Ball	6	18	5,000	1,600	6	1.8	4,500	1,200	6	1.8	4,500	810	6	1.8
		26	5,000	1,600	6	1.46	3,990	1,060	6	1.46	3,990	710	6	1.46
		32	5,000	1,600	6	1.2	3,600	960	6	1.2	3,600	640	6	1.2
Taper Neck Ball	8	24	3,000	1,300	8	2.4	2,900	1,050	8	2.4	2,900	720	8	2.4
		34	3,000	1,300	8	1.96	2,570	930	8	1.96	2,570	640	8	1.96
		42	3,000	1,300	8	1.6	2,300	840	8	1.6	2,300	570	8	1.6
Taper	10	30	1,600	1,000	10	3	1,500	900	10	3	1,500	580	10	3
		42	1,600	1,000	10	2.45	1,340	800	10	2.45	1,340	510	10	2.45
		52	1,600	1,000	10	2	1,200	720	10	2	1,200	460	10	2
Spiral V Cutter	12	36	1,200	800	12	3.6	1,200	750	12	3.6	1,200	540	12	3.6
		52	1,200	800	12	2.86	1,050	660	12	2.86	1,050	470	12	2.86
		62	1,200	800	12	2.4	950	600	12	2.4	950	430	12	2.4

Milling Conditions for CXS

WORK MATERIAL			PREHARDENED STEELS HPM / NAK (30~45HRC)				HARDENED STEELS SKD / SKT / STAVAX (45~55HRC)			
Model Number	Outside Diameter (mm)	Effective Length (mm)	Spindle Speed (min ⁻¹)	Feed Rate (mm/min)	a_p Axial Depth (mm)	a_e Radial Depth (mm)	Spindle Speed (min ⁻¹)	Feed Rate (mm/min)	a_p Axial Depth (mm)	a_e Radial Depth (mm)
4010-030	1	3	12,900	400	1	0.3	12,900	180	1	0.15
4010-050		5	11,170	350	1	0.23	12,900	180	1	0.12
4010-060		6	10,300	320	1	0.2	12,900	180	1	0.1
4015-045	1.5	4.5	10,500	500	1.5	0.45	9,500	280	1.5	0.225
4015-070		7	9,190	440	1.5	0.36	9,500	280	1.5	0.18
4015-085		8.5	8,400	400	1.5	0.3	9,500	280	1.5	0.15
4020-060	2	6	9,350	560	2	0.6	8,200	390	2	0.3
4020-090		9	8,210	490	2	0.48	8,200	390	2	0.24
4020-110		11	7,450	440	2	0.4	8,200	390	2	0.2
4025-075	2.5	7.5	8,300	610	2.5	0.75	7,800	510	2.5	0.375
4025-110		11	7,340	530	2.5	0.6	7,800	510	2.5	0.3
4025-135		13.5	6,650	480	2.5	0.5	7,800	510	2.5	0.25
4030-090	3	9	7,400	630	3	0.9	7,400	630	3	0.45
4030-130		13	6,540	560	3	0.73	7,400	630	3	0.36
4030-160		16	5,900	500	3	0.6	7,400	630	3	0.3
4040-120	4	12	5,900	650	4	1.2	5,900	650	4	0.6
4040-170		17	5,230	580	4	0.98	5,900	650	4	0.49
4040-210		21	4,700	520	4	0.8	5,900	650	4	0.4
4050-150	5	15	4,800	680	5	1.5	4,800	670	5	0.75
4050-210		21	4,250	600	5	1.23	4,800	670	5	0.61
4050-260		26	3,800	540	5	1	4,800	670	5	0.5
4060-180	6	18	4,000	680	6	1.8	4,000	680	6	0.9
4060-260		26	3,540	600	6	1.46	4,000	680	6	0.73
4060-320		32	3,200	540	6	1.2	4,000	680	6	0.6
4080-240	8	24	2,500	600	8	2.4	2,500	630	8	1.2
4080-340		34	2,220	530	8	1.96	2,500	630	8	0.98
4080-420		42	2,000	480	8	1.6	2,500	630	8	0.8
4100-300	10	30	1,500	430	10	3	1,500	570	10	1.5
4100-420		42	1,340	380	10	2.45	1,500	570	10	1.23
4100-520		52	1,200	340	10	2	1,500	570	10	1
4120-360	12	36	1,000	320	12	3.6	1,200	530	12	1.8
4120-520		52	880	280	12	2.86	1,200	500	12	1.43
4120-620		62	800	250	12	2.4	1,200	480	12	1.2

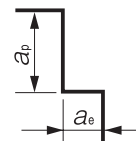

Side Milling
 a_p : Axial Depth (mm)
 a_e : Radial Depth (mm)

4 Flutes

UDC Series

CBN Series

Square

Long Neck Square

Radius

Long Neck Radius

Taper Neck Radius

Ball

Ball / Long Shank Ball

Long Neck Ball

Taper Neck Ball

Taper

Spiral V Cutter

Drill

EURO Series

Technical Data

Milling Conditions for CXS

Slotting

WORK MATERIAL			CARBON STEELS S45C / S50C Annealed Materials (~225HB)			ALLOY STEELS SK / SCM Annealed Materials (225~325HB)			STAINLESS STEELS SUS304 Use water soluble or oil coolant.		
Model Number	Outside Diameter (mm)	Effective Length (mm)	Spindle Speed (min ⁻¹)	Feed Rate (mm/min)	a _p Axial Depth (mm)	Spindle Speed (min ⁻¹)	Feed Rate (mm/min)	a _p Axial Depth (mm)	Spindle Speed (min ⁻¹)	Feed Rate (mm/min)	a _p Axial Depth (mm)
4010-030	1	3	18,000	300	1	18,000	300	1	14,500	280	0.5
4010-050		5	18,000	300	0.67	15,330	260	0.67	12,570	240	0.37
4010-060		6	18,000	300	0.5	14,000	240	0.5	11,600	220	0.3
4015-045	1.5	4.5	13,500	450	1.5	13,500	400	1.5	13,300	300	0.75
4015-070		7	13,500	450	1.03	11,810	350	1.03	11,610	260	0.56
4015-085		8.5	13,500	450	0.75	10,800	320	0.75	10,600	240	0.45
4020-060	2	6	11,000	600	2	11,000	400	2	12,200	320	1
4020-090		9	11,000	600	1.4	9,680	350	1.4	10,730	280	0.76
4020-110		11	11,000	600	1	8,800	320	1	9,750	250	0.6
4025-075	2.5	7.5	9,500	600	2.5	9,500	400	2.5	11,000	340	1.25
4025-110		11	9,500	600	1.77	8,390	350	1.77	9,720	300	0.96
4025-135		13.5	9,500	600	1.25	7,600	320	1.25	8,800	270	0.75
4030-090	3	9	8,500	600	3	8,500	400	3	10,000	360	1.5
4030-130		13	8,500	600	2.57	7,530	350	2.14	8,860	310	1.16
4030-160		16	8,500	600	2.25	6,800	320	1.5	8,000	280	0.9
4040-120	4	12	7,200	650	4	6,700	450	4	7,500	400	2
4040-170		17	7,200	650	3.44	5,920	400	2.89	6,670	360	1.56
4040-210		21	7,200	650	3	5,300	360	2	6,000	320	1.2
4050-150	5	15	6,000	700	5	5,400	500	5	5,400	460	2.5
4050-210		21	6,000	700	4.32	4,800	450	3.64	4,800	410	1.95
4050-260		26	6,000	700	3.75	4,300	400	2.5	4,300	360	1.5
4060-180	6	18	5,000	700	6	4,500	500	6	4,500	460	3
4060-260		26	5,000	700	5.14	3,990	440	4.29	3,990	400	2.31
4060-320		32	5,000	700	4.5	3,600	400	3	3,600	360	1.8
4080-240	8	24	3,000	500	8	2,900	360	8	2,900	360	4
4080-340		34	3,000	500	6.89	2,570	320	5.78	2,570	320	3.11
4080-420		42	3,000	500	6	2,300	280	4	2,300	280	2.4
4100-300	10	30	1,600	380	10	1,500	270	10	1,500	220	5
4100-420		42	1,600	380	8.64	1,340	240	7.27	1,340	190	3.91
4100-520		52	1,600	380	7.5	1,200	210	5	1,200	170	3
4120-360	12	36	1,200	300	12	1,200	210	12	1,200	180	6
4120-520		52	1,200	300	10.15	1,050	180	8.31	1,050	160	4.52
4120-620		62	1,200	300	9	950	160	6	950	140	3.6

- UDC Series
- CBN Series
- Square
- Long Neck Square
- Radius
- Long Neck Radius
- Taper Neck Radius
- Ball / Long Shank Ball
- Long Neck Ball
- Taper Neck Ball
- Taper
- Spiral V Cutter
- Drill
- EURO Series
- Technical Data

Milling Conditions for CXS

WORK MATERIAL			PREHARDENED STEELS HPM / NAK (30~45HRC)			HARDENED STEELS SKD / SKT / STAVAX (45~55HRC)		
Model Number	Outside Diameter (mm)	Effective Length (mm)	Spindle Speed (min ⁻¹)	Feed Rate (mm/min)	a _p Axial Depth (mm)	Spindle Speed (min ⁻¹)	Feed Rate (mm/min)	a _p Axial Depth (mm)
4010-030	1	3	12,900	170	1	12,900	60	0.25
4010-050		5	11,170	140	0.67	setting disable	setting disable	setting disable
4010-060		6	10,300	130	0.5	setting disable	setting disable	setting disable
4015-045	1.5	4.5	10,500	230	1.5	9,500	120	0.375
4015-070		7	9,190	200	1.03	setting disable	setting disable	setting disable
4015-085		8.5	8,400	180	0.75	setting disable	setting disable	setting disable
4020-060	2	6	9,350	280	2	8,200	180	0.5
4020-090		9	8,210	240	1.4	setting disable	setting disable	setting disable
4020-110		11	7,450	220	1	setting disable	setting disable	setting disable
4025-075	2.5	7.5	8,300	300	2.5	7,800	270	0.625
4025-110		11	7,340	270	1.77	setting disable	setting disable	setting disable
4025-135		13.5	6,650	240	1.25	setting disable	setting disable	setting disable
4030-090	3	9	7,400	320	3	7,400	360	1.5
4030-130		13	6,540	280	2.14	setting disable	setting disable	setting disable
4030-160		16	5,900	250	1.5	setting disable	setting disable	setting disable
4040-120	4	12	5,900	390	4	5,900	380	2
4040-170		17	5,230	350	2.89	setting disable	setting disable	setting disable
4040-210		21	4,700	310	2	setting disable	setting disable	setting disable
4050-150	5	15	4,800	440	5	4,800	410	2.5
4050-210		21	4,250	390	3.64	setting disable	setting disable	setting disable
4050-260		26	3,800	350	2.5	setting disable	setting disable	setting disable
4060-180	6	18	4,000	440	6	4,000	440	3
4060-260		26	3,540	390	4.29	setting disable	setting disable	setting disable
4060-320		32	3,200	350	3	setting disable	setting disable	setting disable
4080-240	8	24	2,500	390	8	2,500	340	4
4080-340		34	2,220	350	5.78	setting disable	setting disable	setting disable
4080-420		42	2,000	310	4	setting disable	setting disable	setting disable
4100-300	10	30	1,500	220	10	1,500	240	5
4100-420		42	1,340	190	7.27	setting disable	setting disable	setting disable
4100-520		52	1,200	170	5	setting disable	setting disable	setting disable
4120-360	12	36	1,000	180	12	1,200	220	6
4120-520		52	880	160	8.31	setting disable	setting disable	setting disable
4120-620		62	800	140	6	setting disable	setting disable	setting disable

Contact our sales when milling hardened steels with L/D=5 or longer effective length tools.

Note:

- Decrease both spindle speed and feed rate proportionally in case of chattering.
- These milling parameters are calculated based on the shortest overhang length. Longer overhangs may require an adjustment to the milling parameters.
- Reduce the milling amount and feed rate in accordance with required milling precision.
- Every coolant offers stable milling.
- Recommend water soluble or oil coolant for Stainless Steels and Copper.

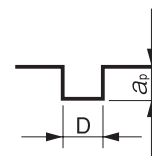

Slotting

a_p : Axial Depth (mm)

D : Outside Diameter (mm)

4 Flutes

UDC Series

CBN Series

Square
Long Neck Square

Radius

Radius
Long Neck Radius

Taper Neck Radius

Ball / Long Shank Ball

Ball
Long Neck Ball

Taper Neck Ball

Taper

Spiral V Cutter

Drill

EURO Series

Technical Data

Cutting Load Comparison CXS $\phi 8$

SKD61 (50HRC)

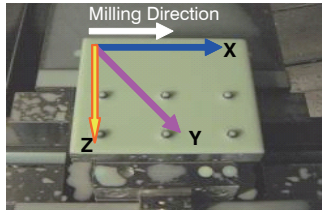

◆Milling Conditions

Spindle Speed	4,200 min ⁻¹
Feed Rate	770 mm/min
Axial Depth a_p	8 mm
Radial Depth a_e	0.3 mm
Coolant	Water Soluble

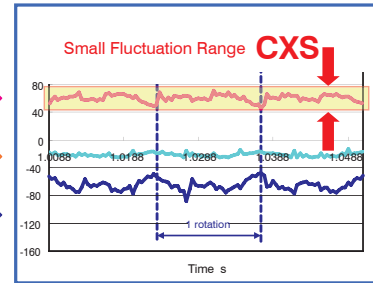
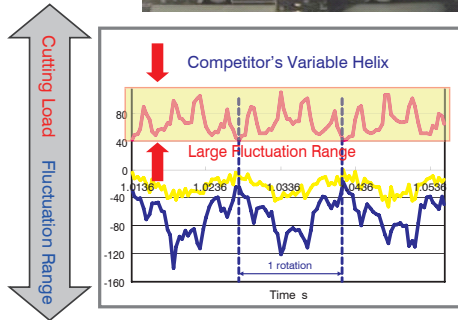

Tool damage and surface quality will be influenced by the cutting load fluctuation range.

CXS has a small fluctuation range and the tool is hard to chatter.

High Efficiency Milling Example CXS $\phi 8$

SUS304

CXS	Competitor A: Roughing	Competitor B: Roughing

◆Milling Conditions

Spindle Speed	5,000 min ⁻¹
Feed Rate	600 mm/min
Axial Depth a_p	8 mm
Radial Depth a_e	3 mm
Coolant	Water Soluble
Milling Distance	5.4 m

※Using company B's milling condition







No tool damage on peripheral flute.

- UDC Series
- CBN Series
- Square
- Long Neck Square
- Radius
- Long Neck Radius
- Taper Neck Radius
- Ball / Long Shark Ball
- Ball
- Long Neck Ball
- Taper Neck Ball
- Taper
- Spiral V Cutter
- Drill
- EURO Series
- Technical Data

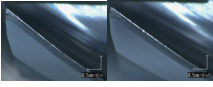
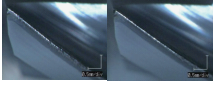
Milling Example by Different Work Materials ① CXS $\phi 8$

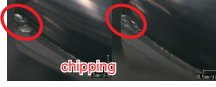
SKD61 (50HRC)

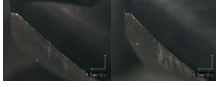
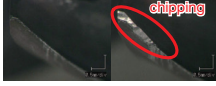
<p>CXS</p>   	<p>Competitor A: Variable Helix</p>   	<p>Competitor B: Variable Helix</p>   	
	<p>Milling Distance 77 m</p>	<p>Milling Distance 44 m</p>	<p>Milling Distance 22 m</p>

Designed for a heavy roughing cut, even up to 50HRC

◆Milling Conditions

Spindle Speed	4,200 min ⁻¹
Feed Rate	770 mm/min
Axial Depth a_p	8 mm
Radial Depth a_e	1 mm
Coolant	Water Soluble

※Using company B's milling condition



Milling Example by Different Work Materials ② CXS $\phi 8$

SUS304

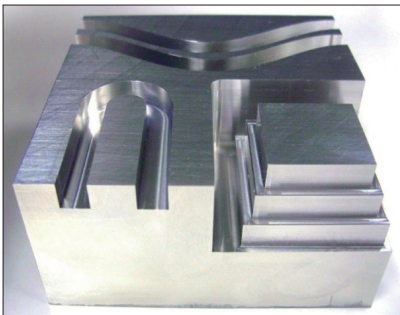

Size : 100 × 100 × 50 mm

◆Milling Conditions

Milling Method	Side Milling, Slotting (One Direction)
Spindle Speed	2,900 min ⁻¹
Feed Rate	360 mm/min (Slotting) 720 mm/min (Side Milling)
Axial Depth a_p	8 mm (1D)
Radial Depth a_e	2.4 mm
Coolant	Water Soluble
Cycle Time	5 min

High efficiency milling of difficult-to-cut material (SUS304).

◆Tool after Milling

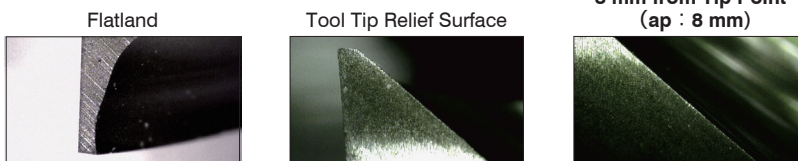

Excellent tool life for high efficiency milling and finishing process.

CXS Series
SUS304
Milling Video



4 Flutes

UDC Series

CBN Series

Square
Long Neck Square

Radius

Long Neck Radius

Taper Neck Radius

Ball / Long Shank Ball

Long Neck Ball

Taper Neck Ball

Taper

Spiral V Cutter

Drill

EURO Series

Technical Data



Size $\phi 1 \sim \phi 12$

C-CRS



Material Applications (☆ Highly Recommended ○ Recommended ○ Suggested)

Work Material															
Carbon Steels S45C S55C	Alloy Steels SK / SCM SUS	Prehardened Steels NAK HPM	Hardened Steels			Cast Iron	Aluminum Alloys	Graphite	Copper	Plastics	Glass Filled Plastics	Titanium Alloys	Heat Resistant Alloys	Cemented Carbide	Hard Brittle (Non-Metallic) Materials
			~55HRC	~60HRC	~70HRC										
○	○	○	○						○				○		

Features

Various range of Corner Radius.

Broad application range from Copper and Carbon Steels up to Hardened Steels (55HRC).

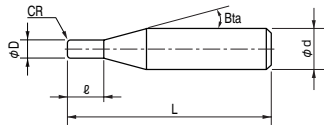

The shank taper angle shown is not an exact value and to avoid contact with the work piece, we recommend the user controls the precise value of this angle. Shank taper angle should not make contact with the work piece.

Total 46 models

Unit (mm)

Model Number	Outside Diameter ϕD	Corner Radius CR	Length of Cut ℓ	Shank Taper Angle Bta	Overall Length L	Shank Diameter ϕd	Price ¥
C-CRS 2010-02	1	RO.2	2	16°	45	4	7,900
C-CRS 2010-03		RO.3			45	4	7,900
C-CRS 2015-02	1.5	RO.2	3	16°	45	4	7,900
C-CRS 2015-03		RO.3			45	4	7,900
C-CRS 2015-05		RO.5			45	4	7,900
C-CRS 2020-02	2	RO.2	4	16°	45	4	7,900
C-CRS 2020-03		RO.3			45	4	7,900
C-CRS 2020-05		RO.5			45	4	7,900
C-CRS 2025-02	2.5	RO.2	5	16°	45	4	7,900
C-CRS 2025-03		RO.3			45	4	7,900
C-CRS 2025-05		RO.5			45	4	8,600
C-CRS 2030-02	3	RO.2	10	16°	45	6	9,030
C-CRS 2030-03		RO.3			45	6	9,030
C-CRS 2030-05		RO.5			45	6	9,980
C-CRS 2030-10		R1			45	6	10,710

Next Page ➡

Unit (mm)

Model Number	Outside Diameter ϕD	Corner Radius CR	Length of Cut l	Shank Taper Angle Bta	Overall Length L	Shank Diameter ϕd	Price ¥
C-CRS 2040-02	4	R0.2	12	16°	45	6	9,140
C-CRS 2040-03		R0.3			45	6	9,140
C-CRS 2040-05		R0.5			45	6	10,080
C-CRS 2040-10		R1			45	6	10,820
C-CRS 2050-02	5	R0.2	15	16°	50	6	9,240
C-CRS 2050-03		R0.3			50	6	9,240
C-CRS 2050-05		R0.5			50	6	10,190
C-CRS 2050-10		R1			50	6	10,920
C-CRS 2060-02	6	R0.2	15	—	50	6	10,190
C-CRS 2060-03		R0.3			50	6	10,190
C-CRS 2060-05		R0.5			50	6	10,400
C-CRS 2060-10		R1			50	6	11,130
C-CRS 2060-15		R1.5			50	6	11,550
C-CRS 2060-20		R2			50	6	11,870
C-CRS 2080-05	8	R0.5	20	—	60	8	14,740
C-CRS 2080-10		R1			60	8	15,510
C-CRS 2080-15		R1.5			60	8	15,950
C-CRS 2080-20		R2			60	8	16,280
C-CRS 2080-25		R2.5			60	8	16,720
C-CRS 2100-05	10	R0.5	25	—	70	10	19,140
C-CRS 2100-10		R1			70	10	19,910
C-CRS 2100-15		R1.5			70	10	20,350
C-CRS 2100-20		R2			70	10	20,680
C-CRS 2100-25		R2.5			70	10	21,120
C-CRS 2100-30		R3		70	10	21,120	
C-CRS 2120-05	12	R0.5	25	—	75	12	23,980
C-CRS 2120-10		R1			75	12	24,750
C-CRS 2120-15		R1.5			75	12	25,190
C-CRS 2120-20		R2			75	12	25,520
C-CRS 2120-25		R2.5			75	12	25,960
C-CRS 2120-30		R3			75	12	25,960

UDC Series

CBN Series

Square

Long Neck Square

Radius

Long Neck Radius

Taper Neck Radius

Ball

Ball / Long Shank Ball

Long Neck Ball

Taper Neck Ball

Taper

Spiral V Cutter

Drill

EURO Series

Technical Data

Milling Conditions for C-CRS

WORK MATERIAL		CARBON STEELS S45C / S50C (~225HB)			ALLOY STEELS SK / SCM / SUS (225~325HB)		
Model Number	Outside Diameter (mm)	Spindle Speed (min ⁻¹)	Feed Rate (mm/min)	a_p Axial Depth (mm)	Spindle Speed (min ⁻¹)	Feed Rate (mm/min)	a_p Axial Depth (mm)
2010	1	16,000	340	0.25	12,700	120	0.25
2020	2	8,000	200	0.5	6,400	120	0.5
2025	2.5	6,300	200	0.63	5,100	120	0.63
2030	3	5,000	200	1.5	4,200	120	1.5
2040	4	4,000	240	2	3,200	150	2
2050	5	3,200	240	2.5	2,550	150	2.5
2060	6	2,650	240	3	2,120	150	3
2080	8	2,000	240	4	1,600	150	4
2100	10	1,600	240	5	1,270	150	5
2120	12	1,330	240	6	1,060	150	6

WORK MATERIAL		PREHARDENED STEELS HARDENED STEELS NAK / SKD (30~45HRC)			HARDENED STEELS SKD / SKT (45~50HRC)		
Model Number	Outside Diameter (mm)	Spindle Speed (min ⁻¹)	Feed Rate (mm/min)	a_p Axial Depth (mm)	Spindle Speed (min ⁻¹)	Feed Rate (mm/min)	a_p Axial Depth (mm)
2010	1	9,550	65	0.25	5,580	22	0.05
2020	2	4,800	55	0.5	2,790	31	0.1
2025	2.5	3,800	55	0.63	2,250	31	0.13
2030	3	3,180	55	1.5	2,120	33	0.15
2040	4	2,390	65	2	1,590	39	0.2
2050	5	1,910	65	2.5	1,270	39	0.25
2060	6	1,590	65	3	1,060	39	0.3
2080	8	1,190	70	4	800	39	0.4
2100	10	950	70	5	640	39	0.5
2120	12	800	70	6	530	39	0.6

Milling Amount for Slotting(mm)

45HRC or below

 $D < \phi 3$ $a_p = 0.25D$ $D \geq \phi 3$ $a_p = 0.5D$

45HRC or above

 $a_p = 0.05D$ a_p : Axial Depth(mm)

D : Outside Diameter(mm)

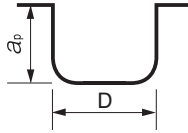

Note:

- Recommend water soluble or oil coolant.
- Recommend oil coolant for Titanium Alloys and Heat Resistant Alloys.

UDC
SeriesCBN
Series

Square

Square

Long Neck
Square

Radius

Radius

Long Neck
RadiusTaper Neck
Radius

Ball

Ball / Long
Shank BallLong Neck
BallTaper Neck
Ball

Taper

Taper

Spiral
V CutterSpiral
V Cutter

Drill

Drill

EURO Series

EURO Series

Technical Data

Technical Data



Size $\phi 6 \sim \phi 12$

CNRS



$\phi 6$ $\phi 8 \sim \phi 12$

Material Applications (☆ Highly Recommended ○ Recommended ○ Suggested)

Work Material															
Carbon Steels S45C S55C	Alloy Steels SK / SCM SUS	Prehardened Steels NAK HPM	Hardened Steels			Cast Iron	Aluminum Alloys	Graphite	Copper	Plastics	Glass Filled Plastics	Titanium Alloys	Heat Resistant Alloys	Cemented Carbide	Hard Brittle (Non-Metallic) Materials
			~55HRC	~60HRC	~70HRC										
○	○	○	○			○	○		○			☆	☆		

Features

4 flute high efficient corner radius designed for Titanium Alloys and Heat Resistant Alloys.
UTCOAT is recommended for heat-resistant hard materials to achieve longer tool life.
Variable pitch, high helix and positive rake angle offer stable milling.
Reduced cutting force when using a helical approach or inclined angles.

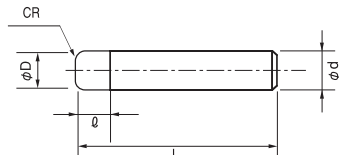

Total 12 models

Unit (mm)

Model Number	Outside Diameter ϕD	Corner Radius CR	Length of Cut ℓ	Overall Length L	Shank Diameter ϕd	Price ¥
CNRS 4060-05-16	6	R0.5	16	90	6	15,000
CNRS 4060-10-16		R1		90		15,000
CNRS 4080-05-16	8	R0.5	16	100	8	17,800
CNRS 4080-10-16		R1		100		17,800
CNRS 4100-05-26	10	R0.5	26	110	10	21,800
CNRS 4100-10-26		R1		110		21,800
CNRS 4100-15-26		R1.5		110		21,800
CNRS 4100-20-26		R2		110		21,800
CNRS 4120-05-26	12	R0.5	26	120	12	27,700
CNRS 4120-10-26		R1		120		27,700
CNRS 4120-15-26		R1.5		120		27,700
CNRS 4120-20-26		R2		120		27,700

Milling Conditions for CNRS

◆ Side Milling

WORK MATERIAL			CARBON STEELS S45C / S50C				ALLOY STEELS SK / SCM				STAINLESS STEELS SUS			
Model Number	Outside Diameter (mm)	Corner Radius (mm)	Spindle Speed (min ⁻¹)	Feed Rate (mm/min)	a_p Axial Depth (mm)	a_e Radial Depth (mm)	Spindle Speed (min ⁻¹)	Feed Rate (mm/min)	a_p Axial Depth (mm)	a_e Radial Depth (mm)	Spindle Speed (min ⁻¹)	Feed Rate (mm/min)	a_p Axial Depth (mm)	a_e Radial Depth (mm)
4060-05-16	6	R0.5	5,180	1,330	9.6	0.9	4,920	1,330	7.2	0.6	3,520	740	4.8	0.3
4060-10-16		R1	5,180	1,330	9.6	0.9	5,180	1,330	7.2	0.6	3,700	740	4.8	0.3
4080-05-16	8	R0.5	3,920	1,260	12.8	1.2	3,720	1,260	9.6	0.8	2,660	700	6.4	0.4
4080-10-16		R1	3,920	1,260	12.8	1.2	3,920	1,260	9.6	0.8	2,800	700	6.4	0.4
4100-05-26	10	R0.5	2,770	1,225	16	1.5	2,630	1,220	12	1	1,880	680	8	0.5
4100-10-26		R1	2,770	1,225	16	1.5	2,770	1,220	12	1	1,980	680	8	0.5
4100-15-26		R1.5	2,770	1,225	16	1.5	2,930	1,220	12	1	2,090	680	8	0.5
4100-20-26		R2	2,770	1,225	16	1.5	3,080	1,220	12	1	2,200	680	8	0.5
4120-05-26	12	R0.5	2,330	1,170	19.2	1.8	2,210	1,170	14.4	1.2	1,580	650	9.6	0.6
4120-10-26		R1	2,330	1,170	19.2	1.8	2,330	1,170	14.4	1.2	1,670	650	9.6	0.6
4120-15-26		R1.5	2,330	1,170	19.2	1.8	2,470	1,170	14.4	1.2	1,760	650	9.6	0.6
4120-20-26		R2	2,330	1,170	19.2	1.8	2,590	1,170	14.4	1.2	1,850	650	9.6	0.6

WORK MATERIAL			TITANIUM / TITANIUM ALLOYS Ti-6Al-4V				HEAT RESISTANT ALLOYS Inconel718			
Model Number	Outside Diameter (mm)	Corner Radius (mm)	Spindle Speed (min ⁻¹)	Feed Rate (mm/min)	a_p Axial Depth (mm)	a_e Radial Depth (mm)	Spindle Speed (min ⁻¹)	Feed Rate (mm/min)	a_p Axial Depth (mm)	a_e Radial Depth (mm)
4060-05-16	6	R0.5	3,520	740	4.8	0.3	1,710	300	4.8	0.3
4060-10-16		R1	3,700	740	4.8	0.3	1,800	300	4.8	0.3
4080-05-16	8	R0.5	2,660	700	6.4	0.4	1,570	280	6.4	0.4
4080-10-16		R1	2,800	700	6.4	0.4	1,650	280	6.4	0.4
4100-05-26	10	R0.5	1,880	680	8	0.5	1,110	250	8	0.5
4100-10-26		R1	1,980	680	8	0.5	1,170	250	8	0.5
4100-15-26		R1.5	2,090	680	8	0.5	1,240	250	8	0.5
4100-20-26		R2	2,200	680	8	0.5	1,300	250	8	0.5
4120-05-26	12	R0.5	1,580	650	9.6	0.6	940	220	9.6	0.6
4120-10-26		R1	1,670	650	9.6	0.6	990	220	9.6	0.6
4120-15-26		R1.5	1,760	650	9.6	0.6	1,050	220	9.6	0.6
4120-20-26		R2	1,850	650	9.6	0.6	1,100	220	9.6	0.6

Please adjust milling parameters referring following table.

D : $\phi 6 \sim \phi 12$

Overhang Length	Spindle Speed (min ⁻¹)	Feed Rate (mm/min)	a_p Axial Depth (mm)	a_e Radial Depth (mm)
$\sim D \times 4$	$\times 1$	$\times 1$	$\times 1$	$\times 1$
$\sim D \times 5$	$\times 0.7$	$\times 0.7$	$\times 0.7$	$\times 0.8$
$\sim D \times 6$	$\times 0.5$	$\times 0.5$	$\times 0.6$	$\times 0.7$

Side Milling

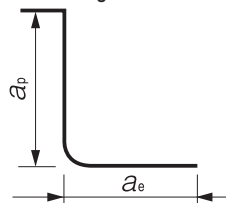

a_p : Axial Depth (mm)
 a_e : Radial Depth (mm)

4 Flutes

UDC Series

CBN Series

Square

Long Neck Square

Radius

Long Neck Radius

Taper Neck Radius

Ball / Long Shank Ball

Long Neck Ball

Taper Neck Ball

Taper

Spiral V Cutter

Drill

EURO Series

Technical Data

Milling Conditions for CNRS

◆Slotting

WORK MATERIAL			CARBON STEELS S45C / S50C			ALLOY STEELS SK / SCM			STAINLESS STEELS SUS		
Model Number	Outside Diameter (mm)	Corner Radius (mm)	Spindle Speed (min ⁻¹)	Feed Rate (mm/min)	a _p Axial Depth (mm)	Spindle Speed (min ⁻¹)	Feed Rate (mm/min)	a _p Axial Depth (mm)	Spindle Speed (min ⁻¹)	Feed Rate (mm/min)	a _p Axial Depth (mm)
4060-05-16	6	R0.5	2,035	250	6	1,930	360	3	1,760	330	1.5
4060-10-16		R1	2,035	250	6	2,040	360	3	1,850	330	1.5
4080-05-16	8	R0.5	1,550	210	8	1,470	300	4	1,340	270	2
4080-10-16		R1	1,550	210	8	1,550	300	4	1,410	270	2
4100-05-26	10	R0.5	1,260	210	10	1,200	300	5	1,090	270	2.5
4100-10-26		R1	1,260	210	10	1,260	300	5	1,150	270	2.5
4100-15-26		R1.5	1,260	210	10	1,330	300	5	1,210	270	2.5
4100-20-26		R2	1,260	210	10	1,400	300	5	1,270	270	2.5
4120-05-26	12	R0.5	1,020	200	12	970	290	6	880	260	3
4120-10-26		R1	1,020	200	12	1,020	290	6	930	260	3
4120-15-26		R1.5	1,020	200	12	1,080	290	6	980	260	3
4120-20-26		R2	1,020	200	12	1,140	290	6	1,030	260	3

WORK MATERIAL			TITANIUM / TITANIUM ALLOYS Ti-6Al-4V			HEAT RESISTANT ALLOYS Inconel718		
Model Number	Outside Diameter (mm)	Corner Radius (mm)	Spindle Speed (min ⁻¹)	Feed Rate (mm/min)	a _p Axial Depth (mm)	Spindle Speed (min ⁻¹)	Feed Rate (mm/min)	a _p Axial Depth (mm)
4060-05-16	6	R0.5	1,600	300	0.6	810	100	0.6
4060-10-16		R1	1,680	300	0.6	850	100	0.6
4080-05-16	8	R0.5	1,220	250	0.8	620	90	0.8
4080-10-16		R1	1,280	250	0.8	650	90	0.8
4100-05-26	10	R0.5	990	250	1	460	80	1
4100-10-26		R1	1,040	250	1	490	80	1
4100-15-26		R1.5	1,100	250	1	520	80	1
4100-20-26		R2	1,160	250	1	540	80	1
4120-05-26	12	R0.5	800	240	1.2	380	70	1.2
4120-10-26		R1	840	240	1.2	410	70	1.2
4120-15-26		R1.5	890	240	1.2	430	70	1.2
4120-20-26		R2	940	240	1.2	450	70	1.2

Please adjust milling parameters referring following table.

D : $\phi 6 \sim \phi 12$

Overhang Length	Spindle Speed (min ⁻¹)	Feed Rate (mm/min)	a _p Axial Depth (mm)	a _r Radial Depth (mm)
~D×4	×1	×1	×1	×1
~D×5	×0.7	×0.7	×0.7	×0.8
~D×6	×0.5	×0.5	×0.6	×0.7

Note:

- Decrease both spindle speed and feed rate proportionally when the milling parameters exceed the machine's maximum spindle speed.
- Recommend water soluble or oil coolant.

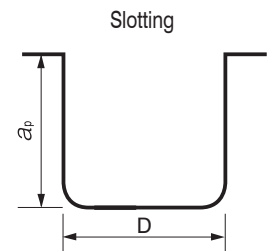

a_p : Axial Depth (mm)
D : Outside Diameter (mm)

Pocket Milling Example: Milling with CNRS $\phi 10 \times CR2$

Ti6Al-4V (30HRC)



Stable milling on hard-to-cut materials

Spindle Speed	Feed Rate	a_p Axial Depth	a_e Radial Depth	Overhang Length	Cycle Time	Coolant	Pocket Size
1,820 min ⁻¹ $V_c=$ 57 m/min	700 mm/min $f_z=$ 0.096 mm/t	0.5 mm	5 mm	45 mm (4.5D)	30 min	Water Soluble (Through Spindle)	70 × 44 × 13 mm

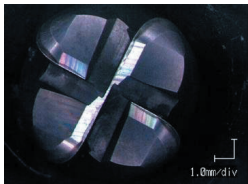

CNRS

Continuous cutting is possible after 60 min milling.

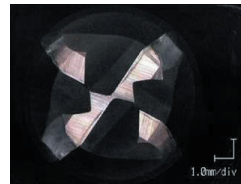
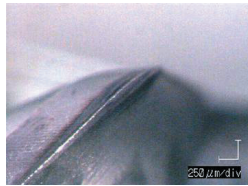
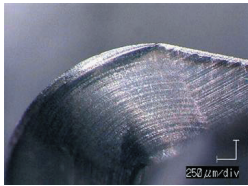

Competitor's Tool

Corner radius is broken after 30min (one pocket) milling.

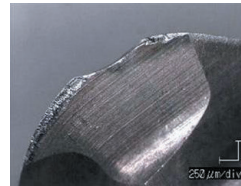

Slotting Example: Milling with CNRS $\phi 8 \times CR1$

Inconel718 (40HRC)

Milling Process	Roughing		Finishing
	Slotting	Side Milling	
Spindle Speed	576 min ⁻¹ ($V_c=14.5$ m/min)	1,650 min ⁻¹ ($V_c=41.5$ m/min)	
Feed Rate	72 mm/min ($f_z=0.03$ mm/t)	280 mm/min ($f_z=0.04$ mm/t)	200 mm/min ($f_z=0.03$ mm/t)
Axial Depth a_p	0.8 mm	6.4 mm	0.1 mm
Radial Depth a_e	—	0.4 mm	0.1 mm
Overhang Length	30 mm (3.75D)		
Coolant	Water Soluble (Nozzle)		
Cycle Time	105 min		10 min

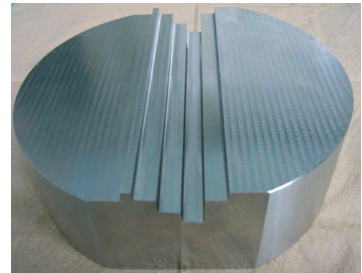

**Reduces burrs in step milling process.
Offers better surface finish with unique cutting edge.**

4 Flutes

UDC Series

CBN Series

Square

Long Neck Square

Radius

Long Neck Radius

Taper Neck Radius

Ball / Long Shank Ball

Long Neck Ball

Taper Neck Ball

Taper

Spiral V Cutter

Drill

EURO Series

Technical Data



Size $\phi 1 \sim \phi 12$

CXERS



Additional 10 models

$\phi 1 \sim \phi 3$ $\phi 4 \sim \phi 6$ $\phi 8 \sim \phi 12$

Material Applications (☆ Highly Recommended ◎ Recommended ○ Suggested)

Work Material															
Carbon Steels S45C S55C	Alloy Steels SK / SCM SUS	Prehardened Steels NAK HPM	Hardened Steels			Cast Iron	Aluminum Alloys	Graphite	Copper	Plastics	Glass Filled Plastics	Titanium Alloys	Heat Resistant Alloys	Cemented Carbide	Hard Brittle (Non-Metallic) Materials
			~55HRC	~60HRC	~70HRC										
○	◎	◎	○			○						○	○		

Features

Variable Division & Variable Helix design minimizes vibration and chattering.

Selected carbide material with high toughness & high chip resistance.

Excellent wear-resistance for the wide range of milling applications, from highly efficient milling to finishing.

Low friction coating resulting in excellent chip evacuation and resistance to wear.

Decreasing cutting resistance and offering stable milling by the original corner R design.

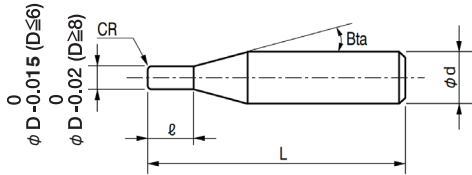

The shank taper angle shown is not an exact value and to avoid contact with the work piece, we recommend the user controls the precise value of this angle. Shank taper angle should not make contact with the work piece.

Total 56 models

Unit (mm)

Model Number	Outside Diameter ϕD	Corner Radius CR	Length of Cut ℓ	Shank Taper Angle Bta	Overall Length L	Shank Diameter ϕd	Price ¥
CXERS 4010-01-025	1	RO.1	2.5	16°	50	4	6,850
CXERS 4010-02-025		RO.2			50	4	6,850
CXERS 4010-03-025		RO.3			50	4	7,300
CXERS 4015-01-0375	1.5	RO.1	3.75	16°	50	4	6,850
CXERS 4015-02-0375		RO.2			50	4	6,850
CXERS 4015-03-0375		RO.3			50	4	7,300
CXERS 4020-01-050	2	RO.1	5	16°	50	4	6,410
CXERS 4020-02-050		RO.2			50	4	6,410
CXERS 4020-03-050		RO.3			50	4	6,850
CXERS 4020-05-050		RO.5			50	4	6,850
CXERS 4025-03-0625	2.5	RO.3	6.25	16°	50	4	6,850
CXERS 4025-05-0625		RO.5			50	4	6,850
CXERS 4030-02-075	3	RO.2	7.5	16°	60	6	7,350
CXERS 4030-03-075		RO.3			60	6	7,850
CXERS 4030-05-075		RO.5			60	6	7,850

Unit (mm)

Model Number	Outside Diameter ϕD	Corner Radius CR	Length of Cut ℓ	Shank Taper Angle $B\alpha$	Overall Length L	Shank Diameter ϕd	Price ¥			
CXERS 4040-02-100	4	R0.2	10	16°	60	6	7,720			
CXERS 4040-03-100		R0.3			60	6	8,250			
※ CXERS 4040-04-100		R0.4			60	6	8,250			
CXERS 4040-05-100		R0.5			60	6	8,250			
CXERS 4040-10-100		R1			60	6	8,250			
CXERS 4050-02-125	5	R0.2	12.5	16°	60	6	8,300			
CXERS 4050-03-125		R0.3			60	6	8,850			
※ CXERS 4050-04-125		R0.4			60	6	8,850			
CXERS 4050-05-125		R0.5			60	6	8,850			
CXERS 4050-10-125		R1			60	6	8,850			
CXERS 4060-02-150	6	R0.2	15	—	60	6	8,640			
CXERS 4060-03-150		R0.3			60	6	8,640			
※ CXERS 4060-04-150		R0.4			60	6	9,500			
CXERS 4060-05-150		R0.5			60	6	9,500			
CXERS 4060-10-150		R1			60	6	9,500			
※ CXERS 4060-12-150		R1.2			60	6	9,500			
CXERS 4080-02-200	8	R0.2	20	—	70	8	11,000			
CXERS 4080-03-200		R0.3			70	8	11,000			
※ CXERS 4080-04-200		R0.4			70	8	11,800			
CXERS 4080-05-200		R0.5			70	8	11,800			
CXERS 4080-10-200		R1			70	8	11,800			
※ CXERS 4080-12-200					R1.2			70	8	11,800
CXERS 4080-15-200					R1.5			70	8	11,800
CXERS 4080-20-200					R2			70	8	11,800
CXERS 4100-02-250	10	R0.2	25	—	80	10	13,100			
CXERS 4100-03-250		R0.3			80	10	13,100			
※ CXERS 4100-04-250		R0.4			80	10	14,000			
CXERS 4100-05-250		R0.5			80	10	14,000			
CXERS 4100-10-250		R1			80	10	14,000			
※ CXERS 4100-12-250					R1.2			80	10	14,000
CXERS 4100-15-250					R1.5			80	10	14,000
CXERS 4100-20-250					R2			80	10	14,000
CXERS 4120-02-300	12	R0.2	30	—	100	12	18,750			
CXERS 4120-03-300		R0.3			100	12	20,000			
※ CXERS 4120-04-300		R0.4			100	12	20,000			
CXERS 4120-05-300		R0.5			100	12	20,000			
CXERS 4120-10-300		R1			100	12	20,000			
※ CXERS 4120-12-300					R1.2			100	12	20,000
CXERS 4120-15-300					R1.5			100	12	20,000
CXERS 4120-20-300					R2			100	12	20,000
CXERS 4120-30-300					R3			100	12	20,000

※Additional model

4 Flutes

UDC Series

CBN Series

Square

Square

Long Neck Square

Radius

Radius

Long Neck Radius

Taper Neck Radius

Ball / Long Shank Ball

Ball

Long Neck Ball

Taper Neck Ball

Taper

Taper

Spiral V Cutter

Drill

EURO Series

Technical Data

Milling Conditions for CXERS

◆Side Milling

WORK MATERIAL			CARBON STEELS S45C / S50C Annealed Materials (~225HB)				ALLOY STEELS SK / SCM Annealed Materials (225~325HB)				STAINLESS STEELS SUS304 ※Use water soluble or oil coolant.			
Model Number	Outside Diameter (mm)	Corner Radius (mm)	Spindle Speed (min ⁻¹)	Feed Rate (mm/min)	a _p Axial Depth (mm)	a _e Radial Depth (mm)	Spindle Speed (min ⁻¹)	Feed Rate (mm/min)	a _p Axial Depth (mm)	a _e Radial Depth (mm)	Spindle Speed (min ⁻¹)	Feed Rate (mm/min)	a _p Axial Depth (mm)	a _e Radial Depth (mm)
4010-01-025	1	R0.1	21,600	490	2.5	0.1	21,600	360	2.5	0.1	17,400	250	2.5	0.1
4010-02-025		R0.2	21,600	490	2.5	0.1	21,600	360	2.5	0.1	17,400	250	2.5	0.1
4010-03-025		R0.3	21,600	490	2.5	0.1	21,600	360	2.5	0.1	17,400	250	2.5	0.1
4015-01-0375	1.5	R0.1	16,200	610	3.75	0.15	16,200	450	3.75	0.15	15,960	270	3.75	0.15
4015-02-0375		R0.2	16,200	610	3.75	0.15	16,200	450	3.75	0.15	15,960	270	3.75	0.15
4015-03-0375		R0.3	16,200	610	3.75	0.15	16,200	450	3.75	0.15	15,960	270	3.75	0.15
4020-01-050	2	R0.1	13,200	740	5	0.2	13,200	550	5	0.2	14,640	280	5	0.2
4020-02-050		R0.2	13,200	740	5	0.2	13,200	550	5	0.2	14,640	280	5	0.2
4020-03-050		R0.3	13,200	740	5	0.2	13,200	550	5	0.2	14,640	280	5	0.2
4020-05-050		R0.5	13,200	740	5	0.2	13,200	550	5	0.2	14,640	280	5	0.2
4025-03-0625	2.5	R0.3	11,400	840	6.25	0.25	11,400	640	6.25	0.25	13,200	390	6.25	0.25
4025-05-0625		R0.5	11,400	840	6.25	0.25	11,400	640	6.25	0.25	13,200	390	6.25	0.25
4030-02-075	3	R0.2	10,200	960	7.5	0.3	10,200	720	7.5	0.3	12,000	510	7.5	0.3
4030-03-075		R0.3	10,200	960	7.5	0.3	10,200	720	7.5	0.3	12,000	510	7.5	0.3
4030-05-075		R0.5	10,200	960	7.5	0.3	10,200	720	7.5	0.3	12,000	510	7.5	0.3
4040-02-100	4	R0.2	8,640	1,350	10	0.8	8,040	1,000	10	0.8	9,000	730	10	0.4
4040-03-100		R0.3	8,640	1,350	10	0.8	8,040	1,000	10	0.8	9,000	730	10	0.4
4040-04-100		R0.4	8,640	1,350	10	0.8	8,040	1,000	10	0.8	9,000	730	10	0.4
4040-05-100		R0.5	8,640	1,350	10	0.8	8,040	1,000	10	0.8	9,000	730	10	0.4
4050-02-125	5	R0.2	7,200	1,500	12.5	1	6,480	1,100	12.5	1	6,480	810	12.5	0.5
4050-03-125		R0.3	7,200	1,500	12.5	1	6,480	1,100	12.5	1	6,480	810	12.5	0.5
4050-04-125		R0.4	7,200	1,500	12.5	1	6,480	1,100	12.5	1	6,480	810	12.5	0.5
4050-05-125		R0.5	7,200	1,500	12.5	1	6,480	1,100	12.5	1	6,480	810	12.5	0.5
4050-10-125		R1	7,200	1,500	12.5	1	6,480	1,100	12.5	1	6,480	810	12.5	0.5
4060-02-150	6	R0.2	6,000	1,600	15	1.2	5,400	1,200	15	1.2	5,400	810	15	0.6
4060-03-150		R0.3	6,000	1,600	15	1.2	5,400	1,200	15	1.2	5,400	810	15	0.6
4060-04-150		R0.4	6,000	1,600	15	1.2	5,400	1,200	15	1.2	5,400	810	15	0.6
4060-05-150		R0.5	6,000	1,600	15	1.2	5,400	1,200	15	1.2	5,400	810	15	0.6
4060-10-150		R1	6,000	1,600	15	1.2	5,400	1,200	15	1.2	5,400	810	15	0.6
4060-12-150		R1.2	6,000	1,600	15	1.2	5,400	1,200	15	1.2	5,400	810	15	0.6
4080-02-200	8	R0.2	3,600	1,300	20	1.6	3,480	1,050	20	1.6	3,480	720	20	0.8
4080-03-200		R0.3	3,600	1,300	20	1.6	3,480	1,050	20	1.6	3,480	720	20	0.8
4080-04-200		R0.4	3,600	1,300	20	1.6	3,480	1,050	20	1.6	3,480	720	20	0.8
4080-05-200		R0.5	3,600	1,300	20	1.6	3,480	1,050	20	1.6	3,480	720	20	0.8
4080-10-200		R1	3,600	1,300	20	1.6	3,480	1,050	20	1.6	3,480	720	20	0.8
4080-12-200		R1.2	3,600	1,300	20	1.6	3,480	1,050	20	1.6	3,480	720	20	0.8
4080-15-200		R1.5	3,600	1,300	20	1.6	3,480	1,050	20	1.6	3,480	720	20	0.8
4080-20-200		R2	3,600	1,300	20	1.6	3,480	1,050	20	1.6	3,480	720	20	0.8
Milling Amount (mm)			a _p : All Flute a _e : 0.1D (φD<4) a _e : 0.2D (φD≥4)				a _p : All Flute a _e : 0.1D (φD<4) a _e : 0.2D (φD≥4)				a _p : All Flute a _e : 0.1D			

Milling Conditions for CXERS

WORK MATERIAL			PREHARDENED STEELS HPM / NAK (30~45HRC)				HARDENED STEELS SKD / SKT / STAVAX (45~55HRC)			
Model Number	Outside Diameter (mm)	Corner Radius (mm)	Spindle Speed (min ⁻¹)	Feed Rate (mm/min)	a _p Axial Depth (mm)	a _e Radial Depth (mm)	Spindle Speed (min ⁻¹)	Feed Rate (mm/min)	a _p Axial Depth (mm)	a _e Radial Depth (mm)
4010-01-025	1	R0.1	15,480	250	2.5	0.1	12,900	180	2.5	0.05
4010-02-025		R0.2	15,480	250	2.5	0.1	12,900	180	2.5	0.05
4010-03-025		R0.3	15,480	250	2.5	0.1	12,900	180	2.5	0.05
4015-01-0375	1.5	R0.1	12,600	310	3.75	0.15	9,300	280	3.75	0.075
4015-02-0375		R0.2	12,600	310	3.75	0.15	9,300	280	3.75	0.075
4015-03-0375		R0.3	12,600	310	3.75	0.15	9,300	280	3.75	0.075
4020-01-050	2	R0.1	11,220	360	5	0.2	7,600	390	5	0.1
4020-02-050		R0.2	11,220	360	5	0.2	7,600	390	5	0.1
4020-03-050		R0.3	11,220	360	5	0.2	7,600	390	5	0.1
4020-05-050		R0.5	11,220	360	5	0.2	7,600	390	5	0.1
4025-03-0625	2.5	R0.3	9,960	430	6.25	0.25	6,500	510	6.25	0.125
4025-05-0625		R0.5	9,960	430	6.25	0.25	6,500	510	6.25	0.125
4030-02-075	3	R0.2	8,880	500	7.5	0.3	5,900	500	7.5	0.3
4030-03-075		R0.3	8,880	500	7.5	0.3	5,900	500	7.5	0.3
4030-05-075		R0.5	8,880	500	7.5	0.3	5,900	500	7.5	0.3
4040-02-100	4	R0.2	7,080	650	10	0.8	4,700	520	10	0.4
4040-03-100		R0.3	7,080	650	10	0.8	4,700	520	10	0.4
4040-04-100		R0.4	7,080	650	10	0.8	4,700	520	10	0.4
4040-05-100		R0.5	7,080	650	10	0.8	4,700	520	10	0.4
4040-10-100		R1	7,080	650	10	0.8	4,700	520	10	0.4
4050-02-125	5	R0.2	5,760	680	12.5	1	3,850	530	12.5	0.5
4050-03-125		R0.3	5,760	680	12.5	1	3,850	530	12.5	0.5
4050-04-125		R0.4	5,760	680	12.5	1	3,850	530	12.5	0.5
4050-05-125		R0.5	5,760	680	12.5	1	3,850	530	12.5	0.5
4050-10-125		R1	5,760	680	12.5	1	3,850	530	12.5	0.5
4060-02-150	6	R0.2	4,800	680	15	1.2	3,200	540	15	0.6
4060-03-150		R0.3	4,800	680	15	1.2	3,200	540	15	0.6
4060-04-150		R0.4	4,800	680	15	1.2	3,200	540	15	0.6
4060-05-150		R0.5	4,800	680	15	1.2	3,200	540	15	0.6
4060-10-150		R1	4,800	680	15	1.2	3,200	540	15	0.6
4060-12-150		R1.2	4,800	680	15	1.2	3,200	540	15	0.6
4080-02-200	8	R0.2	3,000	600	20	1.6	2,000	500	20	0.8
4080-03-200		R0.3	3,000	600	20	1.6	2,000	500	20	0.8
4080-04-200		R0.4	3,000	600	20	1.6	2,000	500	20	0.8
4080-05-200		R0.5	3,000	600	20	1.6	2,000	500	20	0.8
4080-10-200		R1	3,000	600	20	1.6	2,000	500	20	0.8
4080-12-200		R1.2	3,000	600	20	1.6	2,000	500	20	0.8
4080-15-200		R1.5	3,000	600	20	1.6	2,000	500	20	0.8
4080-20-200		R2	3,000	600	20	1.6	2,000	500	20	0.8
Milling Amount (mm)			a _p : All Flute a _e : 0.1D (φD < 4) a _e : 0.2D (φD ≥ 4)				a _p : All Flute a _e : 0.1D			

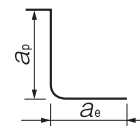

Side Milling
a_p : Axial Depth (mm)
a_e : Radial Depth (mm)

4 Flutes

UDC Series

CBN Series

Square

Long Neck Square

Radius

Long Neck Radius

Taper Neck Radius

Ball / Long Shank Ball

Long Neck Ball

Taper Neck Ball

Taper

Spiral V Cutter

Drill

EURO Series

Technical Data

Milling Conditions for CXERS

◆Side Milling

WORK MATERIAL			CARBON STEELS S45C / S50C Annealed Materials (~225HB)				ALLOY STEELS SK / SCM Annealed Materials (225~325HB)				STAINLESS STEELS SUS304 ※Use water soluble or oil coolant.			
Model Number	Outside Diameter (mm)	Corner Radius (mm)	Spindle Speed (min ⁻¹)	Feed Rate (mm/min)	a _p Axial Depth (mm)	a _e Radial Depth (mm)	Spindle Speed (min ⁻¹)	Feed Rate (mm/min)	a _p Axial Depth (mm)	a _e Radial Depth (mm)	Spindle Speed (min ⁻¹)	Feed Rate (mm/min)	a _p Axial Depth (mm)	a _e Radial Depth (mm)
4100-02-250	10	R0.2	1,920	1,000	25	2	1,800	900	25	2	1,800	580	25	1
4100-03-250		R0.3	1,920	1,000	25	2	1,800	900	25	2	1,800	580	25	1
4100-04-250		R0.4	1,920	1,000	25	2	1,800	900	25	2	1,800	580	25	1
4100-05-250		R0.5	1,920	1,000	25	2	1,800	900	25	2	1,800	580	25	1
4100-10-250		R1	1,920	1,000	25	2	1,800	900	25	2	1,800	580	25	1
4100-12-250		R1.2	1,920	1,000	25	2	1,800	900	25	2	1,800	580	25	1
4100-15-250		R1.5	1,920	1,000	25	2	1,800	900	25	2	1,800	580	25	1
4100-20-250		R2	1,920	1,000	25	2	1,800	900	25	2	1,800	580	25	1
4120-02-300		12	R0.2	1,440	800	30	2.4	1,440	750	30	2.4	1,440	540	30
4120-03-300	R0.3		1,440	800	30	2.4	1,440	750	30	2.4	1,440	540	30	1.2
4120-04-300	R0.4		1,440	800	30	2.4	1,440	750	30	2.4	1,440	540	30	1.2
4120-05-300	R0.5		1,440	800	30	2.4	1,440	750	30	2.4	1,440	540	30	1.2
4120-10-300	R1		1,440	800	30	2.4	1,440	750	30	2.4	1,440	540	30	1.2
4120-12-300	R1.2		1,440	800	30	2.4	1,440	750	30	2.4	1,440	540	30	1.2
4120-15-300	R1.5		1,440	800	30	2.4	1,440	750	30	2.4	1,440	540	30	1.2
4120-20-300	R2		1,440	800	30	2.4	1,440	750	30	2.4	1,440	540	30	1.2
4120-30-300	R3		1,440	800	30	2.4	1,440	750	30	2.4	1,440	540	30	1.2
Milling Amount (mm)			a _p : All Flute a _e : 0.2D (φD ≥ 4)				a _p : All Flute a _e : 0.2D (φD ≥ 4)				a _p : All Flute a _e : 0.1D			

UDC Series

CBN Series

Square
Long Neck Square

Radius

Long Neck Radius
Taper Neck Radius

Ball / Long Shank Ball

Long Neck Ball

Taper Neck Ball

Taper

Spiral V Cutter

Drill

EURO Series

Technical Data

Milling Conditions for CXERS

WORK MATERIAL			PREHARDENED STEELS HPM / NAK (30~45HRC)				HARDENED STEELS SKD / SKT / STAVAX (45~55HRC)			
Model Number	Outside Diameter (mm)	Corner Radius (mm)	Spindle Speed (min ⁻¹)	Feed Rate (mm/min)	a_p Axial Depth (mm)	a_e Radial Depth (mm)	Spindle Speed (min ⁻¹)	Feed Rate (mm/min)	a_p Axial Depth (mm)	a_e Radial Depth (mm)
4100-02-250	10	R0.2	1,800	430	25	2	1,200	450	25	1
4100-03-250		R0.3	1,800	430	25	2	1,200	450	25	1
4100-04-250		R0.4	1,800	430	25	2	1,200	450	25	1
4100-05-250		R0.5	1,800	430	25	2	1,200	450	25	1
4100-10-250		R1	1,800	430	25	2	1,200	450	25	1
4100-12-250		R1.2	1,800	430	25	2	1,200	450	25	1
4100-15-250		R1.5	1,800	430	25	2	1,200	450	25	1
4100-20-250		R2	1,800	430	25	2	1,200	450	25	1
4120-02-300		12	R0.2	1,200	320	30	2.4	960	420	30
4120-03-300	R0.3		1,200	320	30	2.4	960	420	30	1.2
4120-04-300	R0.4		1,200	320	30	2.4	960	420	30	1.2
4120-05-300	R0.5		1,200	320	30	2.4	960	420	30	1.2
4120-10-300	R1		1,200	320	30	2.4	960	420	30	1.2
4120-12-300	R1.2		1,200	320	30	2.4	960	420	30	1.2
4120-15-300	R1.5		1,200	320	30	2.4	960	420	30	1.2
4120-20-300	R2		1,200	320	30	2.4	960	420	30	1.2
4120-30-300	R3		1,200	320	30	2.4	960	420	30	1.2
Milling Amount (mm)			a_p : All Flute a_e : 0.2D ($\phi D \geq 4$)				a_p : All Flute a_e : 0.1D			

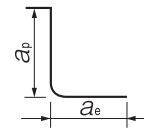

Side Milling
 a_p : Axial Depth (mm)
 a_e : Radial Depth (mm)

4 Flutes

UDC Series

CBN Series

Square
Long Neck Square

Radius

Long Neck Radius

Taper Neck Radius

Ball / Long Shank Ball
Long Neck Ball

Taper Neck Ball

Taper

Spiral V Cutter

Drill

EURO Series

Technical Data

Milling Conditions for CXERS

◆Slotting

WORK MATERIAL			CARBON STEELS S45C / S50C Annealed Materials (~225HB)			ALLOY STEELS SK / SCM Annealed Materials (225~325HB)			STAINLESS STEELS SUS304 ※ Use water soluble or oil coolant.		
Model Number	Outside Diameter (mm)	Corner Radius (mm)	Spindle Speed (min ⁻¹)	Feed Rate (mm/min)	a _p Axial Depth (mm)	Spindle Speed (min ⁻¹)	Feed Rate (mm/min)	a _p Axial Depth (mm)	Spindle Speed (min ⁻¹)	Feed Rate (mm/min)	a _p Axial Depth (mm)
4010-01-025	1	R0.1	21,600	160	1	21,600	160	1	17,400	170	0.5
4010-02-025		R0.2	21,600	160	1	21,600	160	1	17,400	170	0.5
4010-03-025		R0.3	21,600	160	1	21,600	160	1	17,400	170	0.5
4015-01-0375	1.5	R0.1	16,200	250	1.5	16,200	220	1.5	15,960	190	0.75
4015-02-0375		R0.2	16,200	250	1.5	16,200	220	1.5	15,960	190	0.75
4015-03-0375		R0.3	16,200	250	1.5	16,200	220	1.5	15,960	190	0.75
4020-01-050	2	R0.1	13,200	360	2	13,200	250	2	14,640	200	1
4020-02-050		R0.2	13,200	360	2	13,200	250	2	14,640	200	1
4020-03-050		R0.3	13,200	360	2	13,200	250	2	14,640	200	1
4020-05-050		R0.5	13,200	360	2	13,200	250	2	14,640	200	1
4025-03-0625	2.5	R0.3	11,400	430	2.5	11,400	280	2.5	13,200	240	1.25
4025-05-0625		R0.5	11,400	430	2.5	11,400	280	2.5	13,200	240	1.25
4030-02-075	3	R0.2	10,200	480	3	10,200	320	3	12,000	280	1.5
4030-03-075		R0.3	10,200	480	3	10,200	320	3	12,000	280	1.5
4030-05-075		R0.5	10,200	480	3	10,200	320	3	12,000	280	1.5
4040-02-100	4	R0.2	8,640	650	4	8,040	450	4	9,000	400	2
4040-03-100		R0.3	8,640	650	4	8,040	450	4	9,000	400	2
4040-04-100		R0.4	8,640	650	4	8,040	450	4	9,000	400	2
4040-05-100		R0.5	8,640	650	4	8,040	450	4	9,000	400	2
4040-10-100		R1	8,640	650	4	8,040	450	4	9,000	400	2
4050-02-125	5	R0.2	7,200	700	5	6,480	500	5	6,480	460	2.5
4050-03-125		R0.3	7,200	700	5	6,480	500	5	6,480	460	2.5
4050-04-125		R0.4	7,200	700	5	6,480	500	5	6,480	460	2.5
4050-05-125		R0.5	7,200	700	5	6,480	500	5	6,480	460	2.5
4050-10-125		R1	7,200	700	5	6,480	500	5	6,480	460	2.5
4060-02-150	6	R0.2	6,000	700	6	5,400	500	6	5,400	460	3
4060-03-150		R0.3	6,000	700	6	5,400	500	6	5,400	460	3
4060-04-150		R0.4	6,000	700	6	5,400	500	6	5,400	460	3
4060-05-150		R0.5	6,000	700	6	5,400	500	6	5,400	460	3
4060-10-150		R1	6,000	700	6	5,400	500	6	5,400	460	3
4060-12-150		R1.2	6,000	700	6	5,400	500	6	5,400	460	3
4080-02-200	8	R0.2	3,600	500	8	3,480	360	8	3,480	340	4
4080-03-200		R0.3	3,600	500	8	3,480	360	8	3,480	340	4
4080-04-200		R0.4	3,600	500	8	3,480	360	8	3,480	340	4
4080-05-200		R0.5	3,600	500	8	3,480	360	8	3,480	340	4
4080-10-200		R1	3,600	500	8	3,480	360	8	3,480	340	4
4080-12-200		R1.2	3,600	500	8	3,480	360	8	3,480	340	4
4080-15-200		R1.5	3,600	500	8	3,480	360	8	3,480	340	4
4080-20-200		R2	3,600	500	8	3,480	360	8	3,480	340	4
Milling Amount (mm)			a _p :1D			a _p :1D			a _p :0.5D		

- UDC Series
- CBN Series
- Square
- Long Neck Square
- Radius
- Long Neck Radius
- Taper Neck Radius
- Ball / Long Shank Ball
- Long Neck Ball
- Taper Neck Ball
- Taper
- Spiral V Cutter
- Drill
- EURO Series
- Technical Data

Milling Conditions for CXERS

WORK MATERIAL			PREHARDENED STEELS HPM / NAK (30~45HRC)			HARDENED STEELS SKD / SKT / STAVAX (45~55HRC)		
Model Number	Outside Diameter (mm)	Corner Radius (mm)	Spindle Speed (min ⁻¹)	Feed Rate (mm/min)	a _p Axial Depth (mm)	Spindle Speed (min ⁻¹)	Feed Rate (mm/min)	a _p Axial Depth (mm)
4010-01-025	1	R0.1	15,480	100	1	12,900	50	0.3
4010-02-025		R0.2	15,480	100	1	12,900	50	0.3
4010-03-025		R0.3	15,480	100	1	12,900	50	0.3
4015-01-0375	1.5	R0.1	12,600	140	1.5	10,500	100	0.45
4015-02-0375		R0.2	12,600	140	1.5	10,500	100	0.45
4015-03-0375		R0.3	12,600	140	1.5	10,500	100	0.45
4020-01-050	2	R0.1	11,220	170	2	9,350	150	0.6
4020-02-050		R0.2	11,220	170	2	9,350	150	0.6
4020-03-050		R0.3	11,220	170	2	9,350	150	0.6
4020-05-050		R0.5	11,220	170	2	9,350	150	0.6
4025-03-0625	2.5	R0.3	9,960	210	2.5	8,300	240	0.75
4025-05-0625		R0.5	9,960	210	2.5	8,300	240	0.75
4030-02-075	3	R0.2	8,880	250	3	7,400	360	1.5
4030-03-075		R0.3	8,880	250	3	7,400	360	1.5
4030-05-075		R0.5	8,880	250	3	7,400	360	1.5
4040-02-100	4	R0.2	7,080	390	4	5,900	380	2
4040-03-100		R0.3	7,080	390	4	5,900	380	2
4040-04-100		R0.4	7,080	390	4	5,900	380	2
4040-05-100		R0.5	7,080	390	4	5,900	380	2
4040-10-100		R1	7,080	390	4	5,900	380	2
4050-02-125	5	R0.2	5,760	440	5	4,800	410	2.5
4050-03-125		R0.3	5,760	440	5	4,800	410	2.5
4050-04-125		R0.4	5,760	440	5	4,800	410	2.5
4050-05-125		R0.5	5,760	440	5	4,800	410	2.5
4050-10-125		R1	5,760	440	5	4,800	410	2.5
4060-02-150	6	R0.2	4,800	440	6	4,000	440	3
4060-03-150		R0.3	4,800	440	6	4,000	440	3
4060-04-150		R0.4	4,800	440	6	4,000	440	3
4060-05-150		R0.5	4,800	440	6	4,000	440	3
4060-10-150		R1	4,800	440	6	4,000	440	3
4060-12-150		R1.2	4,800	440	6	4,000	440	3
4080-02-200	8	R0.2	3,000	340	8	2,500	340	4
4080-03-200		R0.3	3,000	340	8	2,500	340	4
4080-04-200		R0.4	3,000	340	8	2,500	340	4
4080-05-200		R0.5	3,000	340	8	2,500	340	4
4080-10-200		R1	3,000	340	8	2,500	340	4
4080-12-200		R1.2	3,000	340	8	2,500	340	4
4080-15-200		R1.5	3,000	340	8	2,500	340	4
4080-20-200		R2	3,000	340	8	2,500	340	4
Milling Amount (mm)			a _p : 1D			a _p : 0.5D		

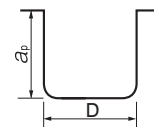

Slotting
a_p : Axial Depth (mm)
D : Outside Diameter (mm)

4 Flutes

UDC Series

CBN Series

Square

Long Neck Square

Radius

Long Neck Radius

Taper Neck Radius

Ball / Long Shank Ball

Long Neck Ball

Taper Neck Ball

Taper Taper

Spiral V Cutter

Drill

EURO Series

Technical Data

Milling Conditions for CXERS

◆Slotting

WORK MATERIAL			CARBON STEELS S45C / S50C Annealed Materials (~225HB)			ALLOY STEELS SK / SCM Annealed Materials (225~325HB)			STAINLESS STEELS SUS304 ※ Use water soluble or oil coolant.		
Model Number	Outside Diameter (mm)	Corner Radius (mm)	Spindle Speed (min ⁻¹)	Feed Rate (mm/min)	a _p Axial Depth (mm)	Spindle Speed (min ⁻¹)	Feed Rate (mm/min)	a _p Axial Depth (mm)	Spindle Speed (min ⁻¹)	Feed Rate (mm/min)	a _p Axial Depth (mm)
4100-02-250	10	R0.2	1,920	380	10	1,800	270	10	1,800	220	5
4100-03-250		R0.3	1,920	380	10	1,800	270	10	1,800	220	5
4100-04-250		R0.4	1,920	380	10	1,800	270	10	1,800	220	5
4100-05-250		R0.5	1,920	380	10	1,800	270	10	1,800	220	5
4100-10-250		R1	1,920	380	10	1,800	270	10	1,800	220	5
4100-12-250		R1.2	1,920	380	10	1,800	270	10	1,800	220	5
4100-15-250		R1.5	1,920	380	10	1,800	270	10	1,800	220	5
4100-20-250		R2	1,920	380	10	1,800	270	10	1,800	220	5
4120-02-300		12	R0.2	1,440	300	12	1,440	210	12	1,440	180
4120-03-300	R0.3		1,440	300	12	1,440	210	12	1,440	180	6
4120-04-300	R0.4		1,440	300	12	1,440	210	12	1,440	180	6
4120-05-300	R0.5		1,440	300	12	1,440	210	12	1,440	180	6
4120-10-300	R1		1,440	300	12	1,440	210	12	1,440	180	6
4120-12-300	R1.2		1,440	300	12	1,440	210	12	1,440	180	6
4120-15-300	R1.5		1,440	300	12	1,440	210	12	1,440	180	6
4120-20-300	R2		1,440	300	12	1,440	210	12	1,440	180	6
4120-30-300	R3		1,440	300	12	1,440	210	12	1,440	180	6
Milling Amount (mm)			a _p :1D			a _p :1D			a _p :0.5D		

Note:

- Decrease both spindle speed and feed rate proportionally in case of chattering.
- These milling parameters are calculated based on the shortest overhang length. Longer overhangs may require an adjustment to the milling parameters.
- Reduce the milling amount and feed rate in accordance with required milling precision.
- Every coolant offers stable milling.
- Recommend water soluble or oil coolant for Stainless Steels and Copper.

Milling Conditions for CXERS

WORK MATERIAL			PREHARDENED STEELS HPM / NAK (30~45HRC)			HARDENED STEELS SKD / SKT / STAVAX (45~55HRC)		
Model Number	Outside Diameter (mm)	Corner Radius (mm)	Spindle Speed (min ⁻¹)	Feed Rate (mm/min)	a _p Axial Depth (mm)	Spindle Speed (min ⁻¹)	Feed Rate (mm/min)	a _p Axial Depth (mm)
4100-02-250	10	R0.2	1,800	220	10	1,500	240	5
4100-03-250		R0.3	1,800	220	10	1,500	240	5
4100-04-250		R0.4	1,800	220	10	1,500	240	5
4100-05-250		R0.5	1,800	220	10	1,500	240	5
4100-10-250		R1	1,800	220	10	1,500	240	5
4100-12-250		R1.2	1,800	220	10	1,500	240	5
4100-15-250		R1.5	1,800	220	10	1,500	240	5
4100-20-250		R2	1,800	220	10	1,500	240	5
4120-02-300		12	R0.2	1,200	180	12	1,200	220
4120-03-300	R0.3		1,200	180	12	1,200	220	6
4120-04-300	R0.4		1,200	180	12	1,200	220	6
4120-05-300	R0.5		1,200	180	12	1,200	220	6
4120-10-300	R1		1,200	180	12	1,200	220	6
4120-12-300	R1.2		1,200	180	12	1,200	220	6
4120-15-300	R1.5		1,200	180	12	1,200	220	6
4120-20-300	R2		1,200	180	12	1,200	220	6
4120-30-300	R3		1,200	180	12	1,200	220	6
Milling Amount (mm)			a _p : 1D			a _p : 0.5D		

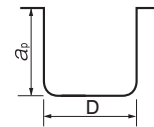

Slotting
 a_p : Axial Depth (mm)
 D : Outside Diameter (mm)

4 Flutes

UDC Series

CBN Series

Square
 Square
 Long Neck Square

Radius
 Radius
 Long Neck Radius
 Taper Neck Radius

Ball / Long Shank Ball
 Ball
 Long Neck Ball
 Taper Neck Ball

Taper
 Taper

Spiral V Cutter
 Spiral V Cutter

Drill
 Drill

EURO Series
 EURO Series

Technical Data
 Technical Data



Size $\phi 3 \sim \phi 12$

CXRS

Super
MG

UT
COAT

42°~45°

R

± 0.01

± 0.015

Shank Dia
0/-0.005

Variable
Pitch

Variable
Helix

$\phi 3 \sim \phi 6$ $\phi 8 \sim \phi 12$

Material Applications (☆ Highly Recommended ◎ Recommended ○ Suggested)

Work Material															
Carbon Steels S45C S55C	Alloy Steels SK / SCM SUS	Prehardened Steels NAK HPM	Hardened Steels			Cast Iron	Aluminum Alloys	Graphite	Copper	Plastics	Glass Filled Plastics	Titanium Alloys	Heat Resistant Alloys	Cemented Carbide	Hard Brittle (Non-Metallic) Materials
			~55HRC	~60HRC	~70HRC										
○	◎	◎	◎			○	○		◎			○	○		

Features

Recommended on a wide range of materials – Carbon Steels and Hardened steels up to 55 HRC. Variable pitch & helix design and positive rake angle offer highly efficient side milling. Seamless corner radius design greatly reduces cutting force.

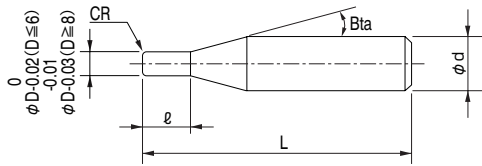

The shank taper angle shown is not an exact value and to avoid contact with the work piece, we recommend the user controls the precise value of this angle. Shank taper angle should not make contact with the work piece.

Variable Pitch

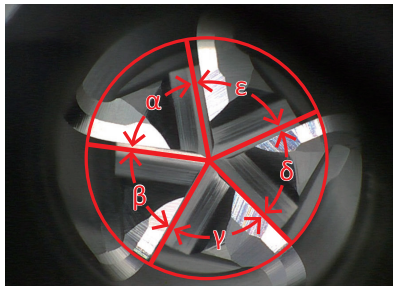

$\alpha \neq \beta \neq \gamma \neq \delta \neq \epsilon$

Corner Radius Design



Variable Helix

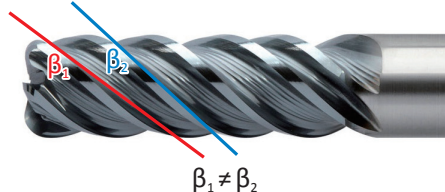

$\beta_1 \neq \beta_2$

UDC Series

CBN Series

Square

Radius

Ball / Long Shank Ball

Long Neck Ball

Taper Neck Ball

Taper

Spiral V Cutter

Drill

EURO Series

Technical Data

Total 30 models

Unit (mm)

Model Number	Outside Diameter ϕD	Corner Radius CR	Length of Cut ℓ	Shank Taper Angle Bta	Overall Length L	Shank Diameter ϕd	Price ¥
CXRS 5030-05-0600	3	R0.5	6	16°	50	6	8,250
CXRS 5030-05-0900			9		50		6
CXRS 5040-05-0800	4	R0.5	8	16°	60	6	8,900
CXRS 5040-05-1200			12		60		6
CXRS 5040-10-0800		R1	8		60	6	8,900
CXRS 5040-10-1200			12		60	6	8,900
CXRS 5060-05-1200	6	R0.5	12	—	70	6	9,600
CXRS 5060-05-1800			18		70		6
CXRS 5060-10-1200		R1	12		70	6	9,600
CXRS 5060-10-1800			18		70	6	9,600
CXRS 5080-05-1600	8	R0.5	16	—	70	8	13,800
CXRS 5080-05-2400			24		70		8
CXRS 5080-10-1600		R1	16		70	8	13,800
CXRS 5080-10-2400			24		70	8	13,800
CXRS 5100-05-2000	10	R0.5	20	—	80	10	16,800
CXRS 5100-05-3000			30		80		10
CXRS 5100-10-2000		R1	20		80	10	16,800
CXRS 5100-10-3000			30		80	10	16,800
CXRS 5100-15-2000		R1.5	20		80	10	16,800
CXRS 5100-15-3000			30		80	10	16,800
CXRS 5100-20-2000		R2	20		80	10	16,800
CXRS 5100-20-3000			30		80	10	16,800
CXRS 5120-05-2400	12	R0.5	24	—	80	12	22,000
CXRS 5120-05-3600			36		100		12
CXRS 5120-10-2400		R1	24		80	12	22,000
CXRS 5120-10-3600			36		100	12	22,000
CXRS 5120-15-2400		R1.5	24		80	12	22,000
CXRS 5120-15-3600			36		100	12	22,000
CXRS 5120-20-2400		R2	24		80	12	22,000
CXRS 5120-20-3600			36		100	12	22,000

5 Flutes

UDC Series

CBN Series

Square

Long Neck Square

Radius

Long Neck Radius

Taper Neck Radius

Ball / Long Shank Ball

Long Neck Ball

Taper Neck Ball

Taper

Spiral V Cutter

Drill

EURO Series

Technical Data

Milling Conditions for CXRS

WORK MATERIAL			CARBON STEELS S45C / S50C Annealed Materials (~225HB)				ALLOY STEELS SK / SCM Annealed Materials (225~325HB)				PREHARDENED STEELS HPM / NAK (30~45HRC)				HARDENED STEELS SKD / SKT / STAVAX (45~55HRC)			
Model Number	Outside Diameter (mm)	Length of Cut (mm)	Spindle Speed (min ⁻¹)	Feed Rate (mm/min)	a _p Axial Depth (mm)	a _e Radial Depth (mm)	Spindle Speed (min ⁻¹)	Feed Rate (mm/min)	a _p Axial Depth (mm)	a _e Radial Depth (mm)	Spindle Speed (min ⁻¹)	Feed Rate (mm/min)	a _p Axial Depth (mm)	a _e Radial Depth (mm)	Spindle Speed (min ⁻¹)	Feed Rate (mm/min)	a _p Axial Depth (mm)	a _e Radial Depth (mm)
5030	3	6	20,000	10,000	6	0.3	20,000	10,000	6	0.3	20,000	10,000	6	0.09	20,000	12,000	6	0.06
		9	20,000	6,000	8	0.24	20,000	6,000	8	0.24	20,000	6,400	8	0.09	20,000	12,000	8	0.05
5040	4	8	18,200	9,100	8	0.4	18,200	9,100	8	0.4	19,800	9,900	8	0.12	15,000	11,500	8	0.08
		12	18,200	5,460	10.8	0.32	18,200	5,460	10.8	0.32	15,900	4,770	10.8	0.12	15,000	11,500	10.8	0.05
5060	6	12	12,200	6,100	12	0.6	12,200	6,100	12	0.6	13,200	6,500	12	0.21	10,000	7,600	12	0.15
		18	12,200	5,100	16	0.48	12,200	5,100	16	0.48	12,000	5,000	16	0.18	10,000	7,600	16	0.1
5080	8	16	9,100	4,550	16	0.8	9,100	4,550	16	0.8	9,900	4,950	16	0.4	7,600	5,600	16	0.2
		24	9,100	4,550	21	0.64	9,100	4,550	21	0.64	9,000	4,500	21	0.32	7,600	5,600	21	0.15
5100	10	20	7,300	3,650	20	1	7,300	3,650	20	1	8,000	4,600	20	0.5	6,000	4,500	20	0.25
		30	7,300	3,650	27	0.8	7,300	3,650	27	0.8	7,300	3,650	27	0.4	6,000	4,500	27	0.22
5120	12	24	6,100	3,050	24	1.2	6,100	3,050	24	1.2	6,600	3,960	24	0.6	5,000	3,800	24	0.3
		36	6,100	3,050	32	0.96	6,100	3,050	32	0.96	6,100	3,050	32	0.48	5,000	3,800	32	0.25

Note:

- Please be sure to use water soluble coolant.
- These milling parameters are for reference only.
- For best result, fine parameter adjustments may be required, depending on the milling shape / application / machine used and so on.
- Decrease both spindle speed and feed rate proportionally when the milling parameters exceed the machine's maximum spindle speed.
- WARNING: Because of high material removal rate, you must pay attention to your chip and coolant management.

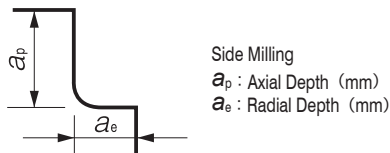

5 Flutes v.s. 4 Flutes Comparison of Cutting Chips

STAVAX (53HRC)

Size : 140 x 200 mm
 Coolant : Oil Mist
 Milling Method : Side Milling
 Spindle Speed : 4,000 min⁻¹
 Feed Rate : 2,500 mm/min
 a_p Axial Depth : 20 mm
 a_e Radial Depth : 0.5 mm

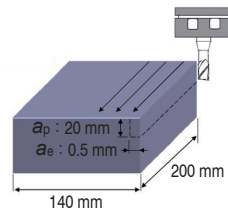

◆ 5 Flute Radius $\phi 10 \times CR0.5 \times$ Length of Cut 20

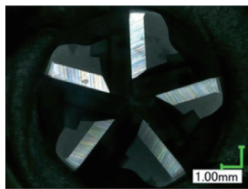

After 40 min

Rake Face

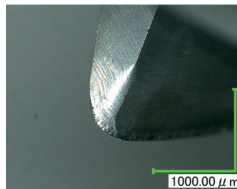

Relief Face

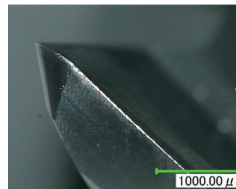

Peripheral Cutting Edge

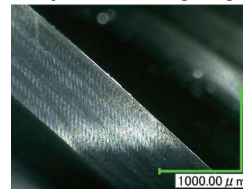

After 80 min

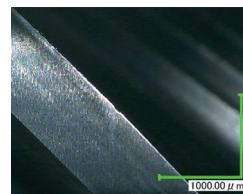
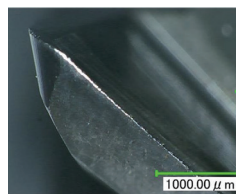
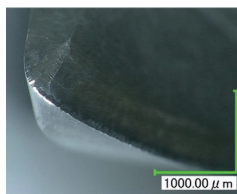

◆ 4 Flute Radius $\phi 10 \times CR1 \times$ Length of Cut 26

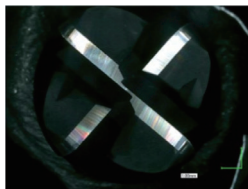

After 40 min

Rake Face

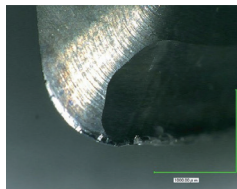

Relief Face



Peripheral Cutting Edge

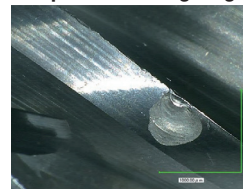

◆ Comparison of Cutting Chips

5 Flutes

Uniform cutting chips



4 Flutes

Irregular size cutting chips



5 flutes, variable pitch and variable helix design protect the tool from chattering and chipping under high-speed condition.

5 Flutes

UDC Series

CBN Series

Square

Long Neck Square

Radius

Long Neck Radius

Taper Neck Radius

Ball / Long Shank Ball

Long Neck Ball

Taper Neck Ball

Taper

Spiral V Cutter

Drill

EURO Series

Technical Data



Size $\phi 3 \sim \phi 12$

HMERS



Material Applications (☆ Highly Recommended ○ Recommended ○ Suggested)

Work Material															
Carbon Steels	Alloy Steels	Prehardened Steels	Hardened Steels			Cast Iron	Aluminum Alloys	Graphite	Copper	Plastics	Glass Filled Plastics	Titanium Alloys	Heat Resistant Alloys	Cemented Carbide	Hard Brittle (Non-Metallic) Materials
S45C S55C	SK / SCM SUS	NAK HPM	~55HRC	~60HRC	~70HRC										
		○	○	○	○										

Features

Radius End Mills for Hard Materials.

4 and 6 Flutes have been applied to suitable sizes to offer outstandingly long tool life.

HARDMAX coat enables highly efficient milling for 65HRC High Speed Steels.

Various Corner Radius sizes available.

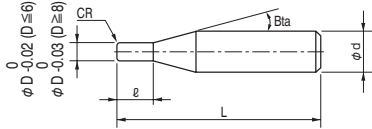

The shank taper angle shown is not an exact value and to avoid contact with the work piece, we recommend the user controls the precise value of this angle. Shank taper angle should not make contact with the work piece.

Total 37 models

Unit (mm)

Model Number	Outside Diameter ϕD	Corner Radius CR	Length of Cut ℓ	Shank Taper Angle β	Overall Length L	Shank Diameter ϕd	Number of Flutes	Price ¥
HMERS 4030-01-075	3	RO.1	7.5	16°	60	6	4	15,000
HMERS 4030-02-075		RO.2			60	6		15,000
HMERS 4030-03-075		RO.3			60	6		15,000
HMERS 4030-05-075		RO.5			60	6		15,000
HMERS 4040-01-100	4	RO.1	10	16°	60	6	4	16,200
HMERS 4040-02-100		RO.2			60	6		16,200
HMERS 4040-03-100		RO.3			60	6		16,200
HMERS 4040-05-100		RO.5			60	6		16,200
HMERS 4040-10-100		R1			60	6		16,200
HMERS 4050-01-125	5	RO.1	12.5	16°	60	6	4	17,400
HMERS 4050-02-125		RO.2			60	6		17,400
HMERS 4050-03-125		RO.3			60	6		17,400
HMERS 4050-05-125		RO.5			60	6		17,400
HMERS 4050-10-125		R1			60	6		17,400

Unit (mm)

Model Number	Outside Diameter ϕD	Corner Radius CR	Length of Cut l	Shank Taper Angle $B\alpha$	Overall Length L	Shank Diameter ϕd	Number of Flutes	Price ¥
HMERS 6060-01-130	6	R0.1	13	—	60	6	6	18,600
HMERS 6060-02-130		R0.2			60	6		18,600
HMERS 6060-03-130		R0.3			60	6		18,600
HMERS 6060-05-130		R0.5			60	6		18,600
HMERS 6060-10-130		R1			60	6		18,600
HMERS 6060-15-130		R1.5			60	6		18,600
HMERS 6080-02-190	8	R0.2	19	—	70	8	6	23,400
HMERS 6080-03-190		R0.3			70	8		23,400
HMERS 6080-05-190		R0.5			70	8		23,400
HMERS 6080-10-190		R1			70	8		23,400
HMERS 6080-20-190		R2			70	8		23,400
HMERS 6100-02-220	10	R0.2	22	—	80	10	6	31,800
HMERS 6100-03-220		R0.3			80	10		31,800
HMERS 6100-05-220		R0.5			80	10		31,800
HMERS 6100-10-220		R1			80	10		31,800
HMERS 6100-15-220		R1.5			80	10		31,800
HMERS 6100-20-220		R2			80	10		31,800
HMERS 6120-02-260	12	R0.2	26	—	100	12	6	38,400
HMERS 6120-03-260		R0.3			100	12		38,400
HMERS 6120-05-260		R0.5			100	12		38,400
HMERS 6120-10-260		R1			100	12		38,400
HMERS 6120-15-260		R1.5			100	12		38,400
HMERS 6120-20-260		R2			100	12		38,400

4 Flutes

6 Flutes

UDC Series

CBN Series

Square
Long Neck Square

Radius

Long Neck Radius

Taper Neck Radius

Ball / Long Shank Ball

Long Neck Ball

Taper Neck Ball

Taper

Spiral V Cutter

Drill

EURO Series

Technical Data

Milling Conditions for HMERS

WORK MATERIAL				PREHARDENED STEELS HARDENED STEELS (40~50HRC)				HARDENED STEELS (50~60HRC)				HARDENED STEELS (60~65HRC)			
Model Number	Number of Flutes	Outside Diameter (mm)	Length of Cut (mm)	Spindle Speed (min ⁻¹)	Feed Rate (mm/min)	a_p Axial Depth (mm)	a_e Radial Depth (mm)	Spindle Speed (min ⁻¹)	Feed Rate (mm/min)	a_p Axial Depth (mm)	a_e Radial Depth (mm)	Spindle Speed (min ⁻¹)	Feed Rate (mm/min)	a_p Axial Depth (mm)	a_e Radial Depth (mm)
4030	4	3	7.5	13,100	1,680	6	0.06	4,200	720	6	0.06	8,600	465	6	0.06
4040	4	4	10	11,300	1,950	8	0.08	3,150	540	8	0.08	6,450	350	8	0.08
4050	4	5	12.5	10,100	2,300	10	0.1	2,520	430	10	0.1	5,160	280	10	0.1
6060	6	6	13	8,900	2,930	12	0.12	4,300	1,200	9	0.12	4,300	1,200	9	0.12
6080	6	8	19	4,000	2,400	12	0.24	3,220	1,450	12	0.08	3,220	1,450	12	0.08
6100	6	10	22	3,200	2,000	15	0.3	2,580	1,160	15	0.1	2,580	1,160	15	0.1
6120	6	12	26	2,670	1,600	18	0.36	2,150	970	18	0.12	2,150	970	18	0.12

Note:

- Recommend down cut processing.
- Reduce cutting amount, feed rate, and apply zero-cut in accordance with required surface quality.
- Recommend air blow or oil mist.

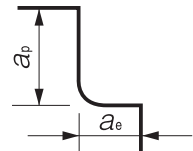

Side Milling

a_p : Axial Depth (mm)

a_e : Radial Depth (mm)

UDC Series

CBN Series

Square

Long Neck Square

Radius

Long Neck Radius

Taper Neck Radius

Ball / Long Shank Ball

Long Neck Ball

Taper Neck Ball

Taper

Spiral V Cutter

Drill

EURO Series

Technical Data

Side Milling Example HMERS $\phi 3 \times CR0.5 / \phi 10 \times CR2$

SKH51 (63 HRC)

Tools after Milling

4030-05-075

6100-20-220

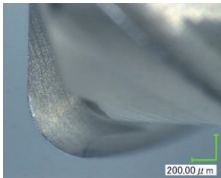
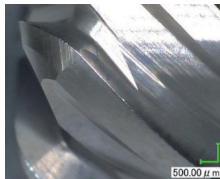
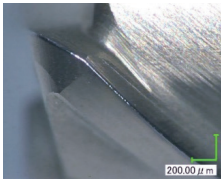
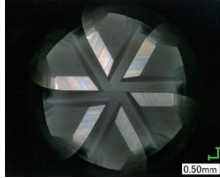
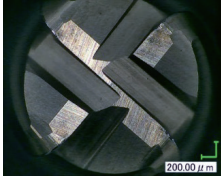

**No chipping when milling Hard Materials.
More tool life left.**

Tool	HMERS 4030-05-075 ($\phi 3 \times CR0.5$)	HMERS 6100-20-220 ($\phi 10 \times CR2$)
Spindle Speed	8,600 min ⁻¹	2,580 min ⁻¹
Feed Rate	465 mm/min	1,160 mm/min
Axial Depth a_p	6 mm	15 mm
Radial Depth a_e	0.06 mm	0.1 mm
Milling Distance	12.7 m	28 m
Coolant	Air Blow (Through Spindle)	

Milling Image

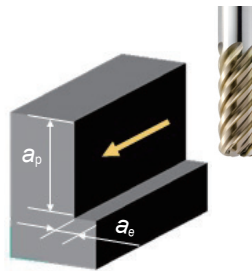

Side Milling (Down-cut)

4 Flutes

6 Flutes

UDC Series

CBN Series

Square
Long Neck Square

Radius

Long Neck Radius

Taper Neck Radius

Ball / Long Shank Ball

Long Neck Ball

Taper Neck Ball

Taper

Spiral V Cutter

Drill

EURO Series

Technical Data



Size $\phi 0.2 \sim \phi 2$

UPDLRS



Material Applications (☆ Highly Recommended ● Recommended ○ Suggested)

Work Material															
Carbon Steels S45C S55C	Alloy Steels SK / SCM SUS	Prehardened Steels NAK HPM	Hardened Steels			Cast Iron	Aluminum Alloys	Graphite	Copper	Plastics	Glass Filled Plastics	Titanium Alloys	Heat Resistant Alloys	Cemented Carbide	Hard Brittle (Non-Metallic) Materials
			~55HRC	~60HRC	~70HRC										
														☆	●

Features

Long Neck Radius End Mills for finishing of Cemented Carbide and Hard Brittle Materials.
 Provides excellent machined surface quality due to the sharp cutting edge and optimized edge treatment.
 Maintains excellent dimensional accuracy for a long time due to the high contour accuracy of the cutting edge and the excellent wear resistance of diamonds.

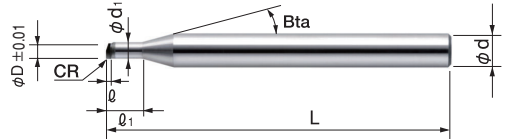
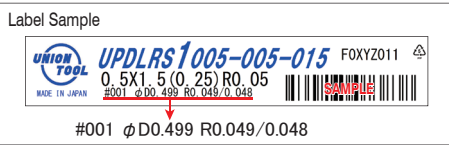

Diameter and Ball R accuracy measurements are printed on the label to support high precision milling.

Be sure to confirm the interference between the inclined work piece and the shank part by actual measurement.

Total 12 models

Unit (mm)

Model Number	Outside Diameter ϕD	Corner Radius CR	Effective Length ℓ_1	Length of Cut ℓ	Neck Diameter ϕd_1	Shank Taper Angle Bta	Overall Length L	Shank Diameter ϕd	Price ¥
UPDLRS 1002-002-006	0.2	R0.02	0.6	0.1	0.175	16°	40	4	Open price
UPDLRS 1002-005-006		R0.05							Open price
UPDLRS 1003-002-010	0.3	R0.02	1	0.15	0.27	16°	40	4	Open price
UPDLRS 1003-005-010		R0.05							Open price
UPDLRS 1005-005-015	0.5	R0.05	1.5	0.25	0.47	16°	40	4	Open price
UPDLRS 1005-010-015		R0.1							Open price
UPDLRS 1010-005-030	1	R0.05	3	0.55	0.95	16°	40	4	Open price
UPDLRS 1010-010-030		R0.1							Open price
UPDLRS 1010-020-030		R0.2							Open price
UPDLRS 1020-005-040	2	R0.05	4	0.55	1.95	16°	40	4	Open price
UPDLRS 1020-010-040		R0.1							Open price
UPDLRS 1020-020-040		R0.2							Open price

Milling Conditions for UPDLRS

WORK MATERIAL			CEMENTED CARBIDE			
Model Number	Outside Diameter (mm)	Effective Length (mm)	Spindle Speed (min ⁻¹)	Feed Rate (mm/min)	Axial Depth (mm)	Radial Depth (mm)
1002-002-006	0.2	0.6	40,000	100	0.001	0.001
1002-005-006			40,000	100	0.001	0.001
1003-002-010	0.3	1	40,000	150	0.002	0.001
1003-005-010			40,000	150	0.002	0.001
1005-005-015	0.5	1.5	40,000	200	0.003	0.001
1005-010-015			40,000	200	0.003	0.001
1010-005-030	1	3	40,000	400	0.005	0.003
1010-010-030			40,000	400	0.005	0.003
1010-020-030			40,000	400	0.005	0.003
1020-005-040	2	4	40,000	600	0.01	0.005
1020-010-040			40,000	600	0.01	0.005
1020-020-040			40,000	600	0.01	0.005



- Note:
- Use a machine with high accuracy for stable cutting.
 - Non-water soluble coolant recommended. Supply as a mist or external coolant. Take fire prevention precautions to avoid fire hazards caused by sparks igniting during machining or tool breakage.
 - Shorten overhang as much as possible.
 - Adjust cutting conditions as necessary as machine spec and other conditions may vary.
 - These cutting parameters show reference value. Adjust the cutting conditions to the desired machined surface finish.

UPDLRS Milling Example for Finishing UDCLRSF / UPDLRS $\phi 2$ Cemented Carbide VF-20 (92.5HRA)

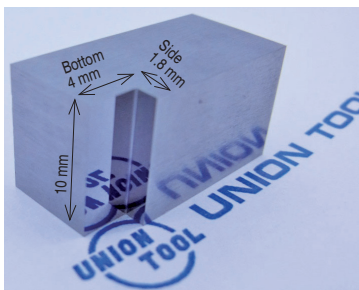

Milling Area : $4 \times 10 \times$ Depth 1.8 mm

Work Size : $10 \times 10 \times 20$ mm

After Finishing

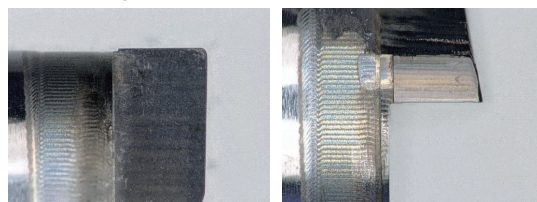

Milling Process	Tool	Spindle Speed (min ⁻¹)	Feed Rate (mm/min)	a_p Axial Depth (mm)	a_e Radial Depth (mm)	Stock (mm)	Coolant	Cycle Time
Roughing	UDCLRSF 2020-005020 ($\phi 2 \times CR0.05 \times$ Effective Length 2)	20,000	400	0.9×2 Times	0.01	0.005	Air Blow	54 min
Finishing (Bottom)	UPDLRS 1020-005-040 ($\phi 2 \times CR0.05 \times$ Effective Length 4)	40,000	600	0.01	0.005	0		45 min
Finishing (Side)		40,000	400	0.002	0.01	0		52 min

UDC Series

CBN Series

Square

Long Neck Square

Radius

Long Neck Radius

Taper Neck Radius

Ball / Long Shank Ball

Long Neck Ball

Taper Neck Ball

Taper

Spiral V Cutter

Drill

EURO Series

Technical Data



Size $\phi 0.2 \sim \phi 6$

HLRS2000/HLRS2000E



Material Applications (☆ Highly Recommended ○ Recommended ○ Suggested)

Work Material															
Carbon Steels S45C S55C	Alloy Steels SK / SCM SUS	Prehardened Steels NAK HPM	Hardened Steels			Cast Iron	Aluminum Alloys	Graphite	Copper	Plastics	Glass Filled Plastics	Titanium Alloys	Heat Resistant Alloys	Cemented Carbide	Hard Brittle (Non-Metallic) Materials
			~55HRC	~60HRC	~70HRC										
○	○	○	○	○	○				○				○		

Total 353 models

Unit (mm)

Model Number	Excellent	Outside Diameter ϕD	Corner Radius CR	Effective Length ℓ_1	Length of Cut ℓ	Neck Diameter ϕd_1	Shank Taper Angle Bta	Overall Length L	Shank Diameter ϕd	Price ¥				
HLRS 2002-005-005E	○	0.2	RO.05	0.5	0.2	0.17	16°	50	4	12,320				
HLRS 2002-005-010E	○			1				50	4	12,320				
HLRS 2002-005-015E	○			1.5				50	4	12,320				
HLRS 2002-005-020E	○			2				50	4	12,320				
HLRS 2003-005-010E	○	0.3	RO.05	1	0.3	0.27	16°	50	4	11,870				
HLRS 2003-005-015E	○			1.5				50	4	11,870				
HLRS 2003-005-020E	○			2				50	4	11,870				
HLRS 2003-005-025E	○			2.5				50	4	13,200				
HLRS 2003-005-030E	○	0.4	RO.05	3	0.4	0.38	16°	50	4	13,200				
HLRS 2004-005-010E	○			1				50	4	7,910				
HLRS 2004-005-015E	○			1.5				50	4	7,910				
HLRS 2004-005-020E	○			2				50	4	7,910				
HLRS 2004-005-030E	○			3				50	4	7,910				
HLRS 2004-005-040E	○			4				50	4	7,910				
HLRS 2004-01-010			0.4	RO.1	1	0.4	0.38	16°	50	4	7,910			
HLRS 2004-01-015					1.5				50	4	7,910			
HLRS 2004-01-020					2				50	4	7,910			
HLRS 2004-01-030					3				50	4	7,910			
HLRS 2004-01-040		4		50	4				7,910					
HLRS 2005-005-010		0.5		RO.05	1				0.5	0.48	16°	50	4	6,440
HLRS 2005-005-020					2							50	4	6,440
HLRS 2005-005-030					3							50	4	6,440
HLRS 2005-005-040					4							50	4	6,440
HLRS 2005-005-050					5							50	4	6,440
HLRS 2005-01-010			0.5	RO.1	1	0.5	0.48	16°				50	4	6,440
HLRS 2005-01-020					2							50	4	6,440
HLRS 2005-01-030					3							50	4	6,440
HLRS 2005-01-040					4							50	4	6,440
HLRS 2005-01-050					5							50	4	6,440
HLRS 2005-01-060		6			50				4	6,440				

Next Page ➡

Features

Long Neck Radius design for high efficiency and high quality milling.
Recommended for various applications from Copper and Raw Materials to Hard Materials.
Both dry and wet coolant offer stable and long tool life.
Refer to page 338 for 4 flute HLRS.

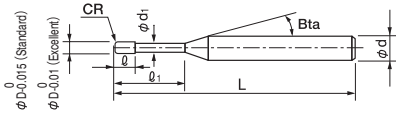

The shank taper angle shown is not an exact value and to avoid contact with the work piece, we recommend the user controls the precise value of this angle. Shank taper angle should not make contact with the work piece.

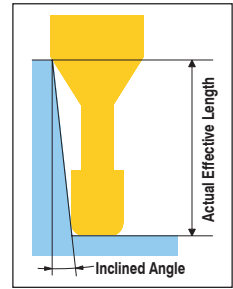

	Diameter Tolerance	Corner Radius Tolerance
Standard Tolerance Type	0/-0.015	Nominal Radius ± 0.005
Excellent Tolerance Type	0/-0.01	Nominal Radius ± 0.005

Unit (mm)

Model Number	Excellent	Outside Diameter ϕD	Corner Radius CR	Effective Length ℓ_1	Effective Length by Inclined Angles				
					30'	1°	1°30'	2°	3°
HLRS 2002-005-005E	○	0.2	RO.05	0.5	0.67	0.71	0.75	0.78	0.85
HLRS 2002-005-010E	○			1	1.20	1.26	1.31	1.36	1.45
HLRS 2002-005-015E	○			1.5	1.72	1.80	1.87	1.92	2.03
HLRS 2002-005-020E	○			2	2.25	2.34	2.41	2.48	2.59
HLRS 2003-005-010E	○	0.3	RO.05	1	1.24	1.31	1.38	1.44	1.55
HLRS 2003-005-015E	○			1.5	1.72	1.83	1.91	1.99	2.12
HLRS 2003-005-020E	○			2	2.26	2.37	2.47	2.55	2.70
HLRS 2003-005-025E	○			2.5	2.78	2.91	3.02	3.11	3.27
HLRS 2003-005-030E	○			3	3.31	3.45	3.57	3.66	3.83
HLRS 2004-005-010E	○	0.4	RO.05	1	1.31	1.40	1.49	1.57	1.72
HLRS 2004-005-015E	○			1.5	1.79	1.92	2.03	2.13	2.31
HLRS 2004-005-020E	○			2	2.33	2.48	2.60	2.71	2.90
HLRS 2004-005-030E	○			3	3.40	3.58	3.72	3.85	4.07
HLRS 2004-005-040E	○			4	4.45	4.66	4.82	4.97	5.21
HLRS 2004-01-010			RO.1	1	1.28	1.38	1.46	1.55	1.69
HLRS 2004-01-015				1.5	1.76	1.90	2.01	2.11	2.28
HLRS 2004-01-020				2	2.30	2.46	2.58	2.69	2.89
HLRS 2004-01-030				3	3.38	3.56	3.71	3.83	4.06
HLRS 2004-01-040				4	4.44	4.64	4.81	4.95	5.20
HLRS 2005-005-010		0.5	RO.05	1	1.34	1.46	1.57	1.67	1.86
HLRS 2005-005-020				2	2.37	2.55	2.71	2.84	3.08
HLRS 2005-005-030				3	3.45	3.67	3.85	4.00	4.27
HLRS 2005-005-040				4	4.52	4.77	4.97	5.14	5.44
HLRS 2005-005-050				5	5.58	5.85	6.07	6.26	6.58
HLRS 2005-01-010			RO.1	1	1.34	1.45	1.56	1.66	1.85
HLRS 2005-01-020				2	2.37	2.55	2.70	2.83	3.07
HLRS 2005-01-030				3	3.45	3.67	3.84	4.00	4.26
HLRS 2005-01-040				4	4.52	4.76	4.96	5.13	5.43
HLRS 2005-01-050				5	5.58	5.85	6.07	6.25	6.57
HLRS 2005-01-060				6	6.63	6.93	7.16	7.36	7.70

Next Page ➡

- UDC Series
- CBN Series
- Square
- Long Neck Square
- Radius
- Long Neck Radius
- Taper Neck Radius
- Ball / Long Shank Ball
- Long Neck Ball
- Taper Neck Ball
- Taper
- Spiral V Cutter
- Drill
- EURO Series
- Technical Data

Model Number	Excellent	Outside Diameter ϕD	Corner Radius CR	Effective Length ℓ_1	Length of Cut ℓ	Neck Diameter ϕd_1	Shank Taper Angle Bta	Overall Length L	Shank Diameter ϕd	Price ¥		
HLRS 2006-005-020		0.6	RO.05	2	0.6	0.58	16°	50	4	6,440		
HLRS 2006-005-030				3				50	4	6,440		
HLRS 2006-005-040				4				50	4	6,440		
HLRS 2006-005-060				6				50	4	6,440		
HLRS 2006-005-080				8				50	4	6,440		
HLRS 2006-01-020				2				RO.1	2	50	4	6,440
HLRS 2006-01-020E	○		2	50					4	7,080		
HLRS 2006-01-030			3	50					4	6,440		
HLRS 2006-01-030E	○		3	50					4	7,080		
HLRS 2006-01-040			4	50					4	6,440		
HLRS 2006-01-040E	○		4	50					4	7,080		
HLRS 2006-01-060			6	50					4	6,440		
HLRS 2006-01-080			8	50					4	6,440		
HLRS 2006-02-020			2	RO.2					2	50	4	6,440
HLRS 2006-02-030			3						50	4	6,440	
HLRS 2006-02-040			4					50	4	6,440		
HLRS 2006-02-060		6	50		4	6,440						
HLRS 2006-02-080		8	50		4	6,440						
HLRS 2007-01-040		0.7	RO.1		4	0.7	0.68	16°	50	4	6,780	
HLRS 2007-01-060				6	50				4	6,780		
HLRS 2007-02-040			RO.2	4	50				4	6,780		
HLRS 2007-02-060				6	50				4	6,780		
HLRS 2008-005-040		0.8	RO.05	4	0.8	0.78	16°	50	4	7,340		
HLRS 2008-005-060				6				50	4	7,340		
HLRS 2008-005-080				8				50	4	7,340		
HLRS 2008-01-040			RO.1	4				50	4	7,340		
HLRS 2008-01-060				6				50	4	7,340		
HLRS 2008-01-080				8				50	4	7,340		
HLRS 2008-02-040				RO.2				4	50	4	7,340	
HLRS 2008-02-060			6					50	4	7,340		
HLRS 2008-02-080			8					50	4	7,340		
HLRS 2010-005-020			1	RO.05				2	1	0.95	16°	50
HLRS 2010-005-030		3			50	4	6,240					
HLRS 2010-005-040		4			50	4	6,240					
HLRS 2010-005-050		5			50	4	6,240					
HLRS 2010-005-060		6			50	4	6,780					
HLRS 2010-005-080		8			50	4	6,780					
HLRS 2010-005-100		10			50	4	6,780					
HLRS 2010-005-120		12			55	4	6,780					
HLRS 2010-005-160		16			60	4	8,990					
HLRS 2010-005-200		20			60	4	9,980					
HLRS 2010-01-020		RO.1		2	50	4	6,240					
HLRS 2010-01-020E	○			2	50	4	6,860					
HLRS 2010-01-030				3	50	4	6,240					
HLRS 2010-01-040				4	50	4	6,240					
HLRS 2010-01-040E	○			4	50	4	6,860					
HLRS 2010-01-050				5	50	4	6,240					
HLRS 2010-01-060				6	50	4	6,780					
HLRS 2010-01-060E	○			6	50	4	7,460					

UDC Series

CBN Series

Square
Long Neck Square

Radius
Long Neck Radius

Taper Neck Radius

Ball / Long Shank Ball
Long Neck Ball
Taper Neck Ball

Taper

Spiral V Cutter

Drill

EURO Series

Technical Data

Model Number	Excellent	Outside Diameter ϕD	Corner Radius CR	Effective Length l_1	Effective Length by Inclined Angles					
					30°	1°	1°30'	2°	3°	
HLRS 2006-005-020		0.6	RO.05	2	2.38	2.61	2.79	2.95	3.22	
HLRS 2006-005-030				3	3.48	3.74	3.95	4.13	4.30	
HLRS 2006-005-040				4	4.56	4.85	5.08	5.28	5.67	
HLRS 2006-005-060				6	6.68	7.03	7.30	7.55	8.12	
HLRS 2006-005-080				8	8.79	9.18	9.50	9.83	10.56	
HLRS 2006-01-020			RO.1	2	2.37	2.60	2.78	2.93	3.20	
HLRS 2006-01-020E	○			2	2.37	2.60	2.78	2.93	3.20	
HLRS 2006-01-030				3	3.47	3.73	3.94	4.11	4.28	
HLRS 2006-01-030E	○			3	3.47	3.73	3.94	4.11	4.28	
HLRS 2006-01-040				4	4.55	4.84	5.07	5.26	5.65	
HLRS 2006-01-040E	○			4	4.55	4.84	5.07	5.26	5.65	
HLRS 2006-01-060				6	6.68	7.03	7.30	7.54	8.10	
HLRS 2006-01-080				8	8.79	9.18	9.50	9.82	10.55	
HLRS 2006-02-020				RO.2	2	2.34	2.56	2.74	2.90	3.18
HLRS 2006-02-030					3	3.44	3.70	3.91	4.09	4.41
HLRS 2006-02-040			4		4.53	4.82	5.05	5.23	5.61	
HLRS 2006-02-060			6		6.66	7.01	7.28	7.51	8.06	
HLRS 2006-02-080			8		8.79	9.17	9.48	9.81	10.53	
HLRS 2007-01-040			0.7	RO.1	4	4.55	4.84	5.07	5.26	5.65
HLRS 2007-01-060					6	6.68	7.03	7.30	7.54	8.10
HLRS 2007-02-040		RO.2		4	4.53	4.82	5.05	5.23	5.61	
HLRS 2007-02-060				6	6.66	7.01	7.28	7.51	8.06	
HLRS 2008-005-040		0.8	RO.05	4	4.56	4.85	5.08	5.28	5.67	
HLRS 2008-005-060				6	6.68	7.03	7.30	7.55	8.12	
HLRS 2008-005-080				8	8.79	9.18	9.50	9.83	10.56	
HLRS 2008-01-040			RO.1	4	4.55	4.84	5.07	5.26	5.65	
HLRS 2008-01-060				6	6.68	7.03	7.30	7.54	8.10	
HLRS 2008-01-080				8	8.79	9.18	9.50	9.82	10.55	
HLRS 2008-02-040			RO.2	4	4.53	4.82	5.05	5.23	5.61	
HLRS 2008-02-060				6	6.66	7.01	7.28	7.51	8.06	
HLRS 2008-02-080				8	8.79	9.17	9.48	9.81	10.53	
HLRS 2010-005-020				1	RO.05	2	2.51	2.86	2.70	3.01
HLRS 2010-005-030		3	3.59			3.82	4.01	4.18	4.51	
HLRS 2010-005-040		4	4.72			4.92	5.14	5.33	5.73	
HLRS 2010-005-050		5	5.72			6.01	6.25	6.47	6.95	
HLRS 2010-005-060		6	6.77			7.09	7.35	7.61	8.18	
HLRS 2010-005-080		8	8.87			9.24	9.55	9.88	10.62	
HLRS 2010-005-100		10	10.97			11.37	11.75	12.16	13.07	
HLRS 2010-005-120		12	13.05			13.50	13.96	14.44	15.52	
HLRS 2010-005-160		16	17.20			17.76	18.36	18.99	20.41	
HLRS 2010-005-200		20	21.33			22.02	22.76	23.55	25.31	
HLRS 2010-01-020		RO.1	2		2.53	2.71	2.88	3.01	3.27	
HLRS 2010-01-020E	○		2		2.53	2.71	2.88	3.01	3.27	
HLRS 2010-01-030			3		3.58	3.81	4.00	4.18	4.49	
HLRS 2010-01-040			4		4.67	4.93	5.14	5.33	5.72	
HLRS 2010-01-040E	○		4		4.67	4.93	5.14	5.33	5.72	
HLRS 2010-01-050			5		5.71	6.00	6.24	6.46	6.94	
HLRS 2010-01-060			6		6.78	7.10	7.36	7.60	8.17	
HLRS 2010-01-060E	○		6		6.78	7.10	7.36	7.60	8.17	

Model Number	Excellent	Outside Diameter ϕD	Corner Radius CR	Effective Length l_1	Length of Cut l	Neck Diameter ϕd_1	Shank Taper Angle Bta	Overall Length L	Shank Diameter ϕd	Price ¥		
HLRS 2010-01-080		1	RO.1	8	1	0.95	16°	50	4	6,780		
HLRS 2010-01-100				10				50	4	6,780		
HLRS 2010-01-120				12				55	4	6,780		
HLRS 2010-01-160				16				60	4	8,990		
HLRS 2010-01-200				20				60	4	9,980		
HLRS 2010-02-020			1	RO.2				2	50	4	6,240	
HLRS 2010-02-020E	○							2	50	4	6,860	
HLRS 2010-02-030								3	50	4	6,240	
HLRS 2010-02-040								4	50	4	6,240	
HLRS 2010-02-040E	○							4	50	4	6,860	
HLRS 2010-02-050				5				50	4	6,240		
HLRS 2010-02-060				RO.2				6	50	4	6,780	
HLRS 2010-02-060E	○							6	50	4	7,460	
HLRS 2010-02-080								8	50	4	6,780	
HLRS 2010-02-100								10	50	4	6,780	
HLRS 2010-02-120								12	55	4	6,780	
HLRS 2010-02-160				16				60	4	8,990		
HLRS 2010-02-200				20				60	4	9,980		
HLRS 2010-03-020				1				RO.3	2	50	4	6,240
HLRS 2010-03-020E	○								2	50	4	6,860
HLRS 2010-03-030		3	50		4	6,240						
HLRS 2010-03-040		4	50		4	6,240						
HLRS 2010-03-040E	○	4	50		4	6,860						
HLRS 2010-03-050		5	50		4	6,240						
HLRS 2010-03-060		RO.3	6		50	4	6,780					
HLRS 2010-03-060E	○		6		50	4	7,460					
HLRS 2010-03-080			8		50	4	6,780					
HLRS 2010-03-100			10		50	4	6,780					
HLRS 2010-03-120			12		55	4	6,780					
HLRS 2010-03-160		16	60		4	8,990						
HLRS 2010-03-200		20	60		4	9,980						
HLRS 2012-02-060		1.2	RO.2		6	1.2	1.14	16°	50	4	7,000	
HLRS 2012-02-120					12				55	4	7,000	
HLRS 2012-02-200				20	60				4	10,620		
HLRS 2012-03-060			RO.3	6	50				4	7,000		
HLRS 2012-03-120				12	55				4	7,000		
HLRS 2012-03-200		20	60	4	10,620							
HLRS 2015-005-040		1.5	RO.05	4	1.5	1.45	16°	50	4	6,650		
HLRS 2015-005-060				6				50	4	6,650		
HLRS 2015-005-080				8				50	4	7,000		
HLRS 2015-005-100				10				50	4	7,000		
HLRS 2015-01-040			RO.1	4				50	4	6,650		
HLRS 2015-01-060				6				50	4	6,650		
HLRS 2015-01-080				8				50	4	7,000		
HLRS 2015-01-100				10				50	4	7,000		
HLRS 2015-01-120				12				55	4	7,000		
HLRS 2015-01-160				16				55	4	7,000		
HLRS 2015-01-200		20	60	4	7,000							

UDC Series

CBN Series

 Square
Long Neck Square

Radius

 Long Neck Radius
Taper Neck Radius

 Ball / Long Shank Ball
Long Neck Ball
Taper Neck Ball

Taper

Spiral V Cutter

Drill

EURO Series

Technical Data

Model Number	Excellent	Outside Diameter ϕD	Corner Radius CR	Effective Length l_1	Effective Length by Inclined Angles					
					30°	1°	1°30'	2°	3°	
HLRS 2010-01-080		1	RO.1	8	8.88	9.24	9.56	9.88	10.61	
HLRS 2010-01-100				10	10.97	11.37	11.76	12.16	13.06	
HLRS 2010-01-120				12	13.05	13.50	13.96	14.44	15.51	
HLRS 2010-01-160				16	17.20	17.76	18.36	18.99	20.40	
HLRS 2010-01-200				20	21.33	22.02	22.76	23.54	25.30	
HLRS 2010-02-020				RO.2	2	2.51	2.69	2.86	2.98	3.23
HLRS 2010-02-020E	○		2		2.51	2.69	2.86	2.98	3.23	
HLRS 2010-02-030			3		3.58	3.80	3.99	4.16	4.47	
HLRS 2010-02-040			4		4.65	4.91	5.12	5.30	5.68	
HLRS 2010-02-040E	○		4		4.65	4.91	5.12	5.30	5.68	
HLRS 2010-02-050			5		5.71	6.00	6.23	6.45	6.92	
HLRS 2010-02-060			6		6.76	7.08	7.34	7.57	8.13	
HLRS 2010-02-060E	○		6		6.76	7.08	7.34	7.57	8.13	
HLRS 2010-02-080			8		8.86	9.22	9.54	9.85	10.57	
HLRS 2010-02-100			10		10.95	11.35	11.74	12.13	13.02	
HLRS 2010-02-120			12		13.03	13.48	13.94	14.41	15.47	
HLRS 2010-02-160			16		17.18	17.74	18.34	18.96	20.36	
HLRS 2010-02-200			20	21.31	22.00	22.74	23.51	25.26		
HLRS 2010-03-020			RO.3	2	2.49	2.67	2.84	2.95	3.19	
HLRS 2010-03-020E	○			2	2.49	2.67	2.84	2.95	3.19	
HLRS 2010-03-030				3	3.57	3.79	3.98	4.14	4.45	
HLRS 2010-03-040				4	4.63	4.89	5.10	5.27	5.64	
HLRS 2010-03-040E	○			4	4.63	4.89	5.10	5.27	5.64	
HLRS 2010-03-050				5	5.70	5.99	6.22	6.43	6.90	
HLRS 2010-03-060				6	6.74	7.06	7.32	7.54	8.09	
HLRS 2010-03-060E	○			6	6.74	7.06	7.32	7.54	8.09	
HLRS 2010-03-080				8	8.84	9.20	9.52	9.82	10.53	
HLRS 2010-03-100				10	10.93	11.33	11.72	12.10	12.98	
HLRS 2010-03-120				12	13.01	13.46	13.92	14.38	15.43	
HLRS 2010-03-160				16	17.16	17.72	18.32	18.93	20.32	
HLRS 2010-03-200			20	21.29	21.98	22.72	23.48	25.22		
HLRS 2012-02-060			1.2	RO.2	6	6.18	6.38	6.59	6.82	7.33
HLRS 2012-02-120					12	12.37	12.77	13.19	13.65	14.67
HLRS 2012-02-200					20	20.62	21.29	22.00	22.76	24.46
HLRS 2012-03-060				RO.3	6	6.18	6.38	6.59	6.81	7.31
HLRS 2012-03-120					12	12.37	12.77	13.19	13.64	14.66
HLRS 2012-03-200		20			20.62	21.28	21.99	22.75	24.45	
HLRS 2015-005-040		1.5	RO.05	4	4.12	4.26	4.40	4.55	4.89	
HLRS 2015-005-060				6	6.18	6.39	6.60	6.83	7.34	
HLRS 2015-005-080				8	8.25	8.52	8.80	9.11	9.79	
HLRS 2015-005-100				10	10.31	10.64	11.00	11.38	12.24	
HLRS 2015-01-040			RO.1	4	4.12	4.25	4.40	4.55	4.89	
HLRS 2015-01-060				6	6.18	6.38	6.60	6.83	7.34	
HLRS 2015-01-080				8	8.24	8.51	8.80	9.10	9.78	
HLRS 2015-01-100				10	10.31	10.64	11.00	11.38	12.23	
HLRS 2015-01-120				12	12.37	12.77	13.20	13.66	14.68	
HLRS 2015-01-160				16	16.50	17.03	17.60	18.21	19.57	
HLRS 2015-01-200				20	20.62	21.29	22.00	22.77	No Interference	

UDC Series

CBN Series

Square

Long Neck Square

Radius

Long Neck Radius

Taper Neck Radius

Ball / Long Shank Ball

Long Neck Ball

Taper Neck Ball

Taper

Spiral V Cutter

Drill

EURO Series

Technical Data

Model Number	Excellent	Outside Diameter ϕD	Corner Radius CR	Effective Length l_1	Length of Cut l	Neck Diameter ϕd_1	Shank Taper Angle Bta	Overall Length L	Shank Diameter ϕd	Price ¥
HLRS 2015-02-040		1.5	RO.2	4	1.5	1.45	16°	50	4	6,650
HLRS 2015-02-060				6				50	4	6,650
HLRS 2015-02-080				8				50	4	7,000
HLRS 2015-02-100				10				50	4	7,000
HLRS 2015-02-120				12				55	4	7,000
HLRS 2015-02-160				16				55	4	7,000
HLRS 2015-02-200				20				60	4	7,000
HLRS 2015-03-040				RO.3				4	50	4
HLRS 2015-03-060			6					50	4	6,650
HLRS 2015-03-080			8					50	4	7,000
HLRS 2015-03-100			10					50	4	7,000
HLRS 2015-03-120			12					55	4	7,000
HLRS 2015-03-160			16					55	4	7,000
HLRS 2015-03-200			20					60	4	7,000
HLRS 2015-05-040			RO.5					4	50	4
HLRS 2015-05-060				6				50	4	6,650
HLRS 2015-05-080				8				50	4	7,000
HLRS 2015-05-100				10				50	4	7,000
HLRS 2015-05-120				12				55	4	7,000
HLRS 2015-05-160				16				55	4	7,000
HLRS 2015-05-200		20		60	4	7,000				
HLRS 2020-005-040		2		RO.05	4	2	1.92	16°	50	4
HLRS 2020-005-060			6		50				4	6,650
HLRS 2020-005-080			8		50				4	7,000
HLRS 2020-005-100			10		50				4	7,000
HLRS 2020-01-040			4		50				4	6,650
HLRS 2020-01-040E	○		4	50	4				7,320	
HLRS 2020-01-060			6	50	4				6,650	
HLRS 2020-01-060E	○		6	50	4				7,320	
HLRS 2020-01-080			8	50	4				7,000	
HLRS 2020-01-080E	○		8	50	4				7,700	
HLRS 2020-01-100			RO.1	10	50				4	7,000
HLRS 2020-01-100E	○			10	50				4	7,700
HLRS 2020-01-120				12	55				4	7,000
HLRS 2020-01-120E	○			12	55				4	7,700
HLRS 2020-01-160				16	60				4	7,000
HLRS 2020-01-200				20	60				4	7,000
HLRS 2020-01-260				26	70				4	7,000
HLRS 2020-01-300				30	70				4	7,000
HLRS 2020-02-040			RO.2	4	50				4	6,650
HLRS 2020-02-040E	○			4	50				4	7,320
HLRS 2020-02-060		6		50	4	6,650				
HLRS 2020-02-060E	○	6		50	4	7,320				
HLRS 2020-02-080		8		50	4	7,000				
HLRS 2020-02-080E	○	8		50	4	7,700				
HLRS 2020-02-100		10		50	4	7,000				
HLRS 2020-02-100E	○	10		50	4	7,700				

- UDC Series
- CBN Series
- Square
- Long Neck Square
- Radius
- Long Neck Radius
- Taper Neck Radius
- Ball / Long Shank Ball
- Long Neck Ball
- Taper Neck Ball
- Taper
- Spiral V Cutter
- Drill
- EURO Series
- Technical Data

Model Number	Excellent	Outside Diameter ϕD	Corner Radius CR	Effective Length l_1	Effective Length by Inclined Angles				
					30°	1°	1°30'	2°	3°
HLRS 2015-02-040		1.5	RO.2	4	4.12	4.25	4.39	4.54	4.88
HLRS 2015-02-060				6	6.18	6.38	6.59	6.82	7.33
HLRS 2015-02-080				8	8.24	8.51	8.79	9.10	9.77
HLRS 2015-02-100				10	10.31	10.64	10.99	11.37	12.22
HLRS 2015-02-120				12	12.37	12.77	13.19	13.65	14.67
HLRS 2015-02-160				16	16.49	17.03	17.60	18.21	19.56
HLRS 2015-02-200				20	20.62	21.29	22.00	22.76	No Interference
HLRS 2015-03-040				RO.3	4	4.12	4.25	4.39	4.54
HLRS 2015-03-060			6		6.18	6.38	6.59	6.81	7.31
HLRS 2015-03-080			8		8.24	8.51	8.79	9.09	9.76
HLRS 2015-03-100			10		10.30	10.64	10.99	11.37	12.21
HLRS 2015-03-120			12		12.37	12.77	13.19	13.64	14.66
HLRS 2015-03-160			16		16.49	17.02	17.59	18.20	19.55
HLRS 2015-03-200			20		20.62	21.28	21.99	22.75	No Interference
HLRS 2015-05-040			RO.5		4	4.11	4.24	4.38	4.52
HLRS 2015-05-060				6	6.18	6.37	6.58	6.80	7.29
HLRS 2015-05-080				8	8.24	8.50	8.78	9.08	9.74
HLRS 2015-05-100				10	10.30	10.63	10.98	11.35	12.19
HLRS 2015-05-120				12	12.36	12.76	13.18	13.63	14.64
HLRS 2015-05-160				16	16.49	17.02	17.58	18.19	19.53
HLRS 2015-05-200		20		20.62	21.28	21.98	22.74	24.42	
HLRS 2020-005-040		RO.05		4	4.16	4.29	4.44	4.59	4.94
HLRS 2020-005-060			6	6.22	6.42	6.64	6.87	7.38	
HLRS 2020-005-080			8	8.28	8.55	8.84	9.15	9.83	
HLRS 2020-005-100			10	10.35	10.68	11.04	11.42	12.28	
HLRS 2020-01-040			RO.1	4	4.16	4.29	4.43	4.59	4.93
HLRS 2020-01-040E	○			4	4.16	4.29	4.43	4.59	4.93
HLRS 2020-01-060				6	6.22	6.42	6.64	6.87	7.38
HLRS 2020-01-060E	○			6	6.22	6.42	6.64	6.87	7.38
HLRS 2020-01-080				8	8.28	8.55	8.84	9.14	9.83
HLRS 2020-01-080E	○			8	8.28	8.55	8.84	9.14	9.83
HLRS 2020-01-100		10		10.34	10.68	11.04	11.42	12.27	
HLRS 2020-01-100E	○	10		10.34	10.68	11.04	11.42	12.27	
HLRS 2020-01-120		12		12.41	12.81	13.24	13.70	14.72	
HLRS 2020-01-120E	○	12		12.41	12.81	13.24	13.70	14.72	
HLRS 2020-01-160		16	16.53	17.07	17.64	18.25	No Interference		
HLRS 2020-01-200		20	20.66	21.33	22.04	22.81	No Interference		
HLRS 2020-01-260		26	26.85	27.72	28.65	No Interference	No Interference		
HLRS 2020-01-300		30	30.97	31.98	33.05	No Interference	No Interference		
HLRS 2020-02-040		RO.2	4	4.15	4.29	4.43	4.58	4.92	
HLRS 2020-02-040E	○		4	4.15	4.29	4.43	4.58	4.92	
HLRS 2020-02-060			6	6.22	6.42	6.63	6.86	7.37	
HLRS 2020-02-060E	○		6	6.22	6.42	6.63	6.86	7.37	
HLRS 2020-02-080			8	8.28	8.55	8.83	9.14	9.82	
HLRS 2020-02-080E	○		8	8.28	8.55	8.83	9.14	9.82	
HLRS 2020-02-100			10	10.34	10.68	11.03	11.41	12.26	
HLRS 2020-02-100E	○		10	10.34	10.68	11.03	11.41	12.26	

UDC Series

CBN Series

Square
Long Neck SquareRadius
Long Neck Radius
Taper Neck RadiusBall / Long Shank Ball
Long Neck Ball
Taper Neck Ball

Taper

Spiral V Cutter

Drill

EURO Series

Technical Data

Model Number	Excellent	Outside Diameter ϕD	Corner Radius CR	Effective Length l_1	Length of Cut l	Neck Diameter ϕd_1	Shank Taper Angle Bta	Overall Length L	Shank Diameter ϕd	Price ¥	
HLRS 2020-02-120		2	RO.2	12	2	1.92	16°	55	4	7,000	
HLRS 2020-02-120E	○			12				55	4	7,700	
HLRS 2020-02-160				16				60	4	7,000	
HLRS 2020-02-200				20				60	4	7,000	
HLRS 2020-02-260				26				70	4	7,000	
HLRS 2020-02-300				30				70	4	7,000	
HLRS 2020-03-040			RO.3	4				50	4	6,650	
HLRS 2020-03-040E	○			4				50	4	7,320	
HLRS 2020-03-060				6				50	4	6,650	
HLRS 2020-03-060E	○			6				50	4	7,320	
HLRS 2020-03-080				8				50	4	7,000	
HLRS 2020-03-080E	○			8				50	4	7,700	
HLRS 2020-03-100				10				50	4	7,000	
HLRS 2020-03-100E	○			10				50	4	7,700	
HLRS 2020-03-120				12				55	4	7,000	
HLRS 2020-03-120E	○			12				55	4	7,700	
HLRS 2020-03-160				16				60	4	7,000	
HLRS 2020-03-200				20				60	4	7,000	
HLRS 2020-03-260				26				70	4	7,000	
HLRS 2020-03-300				30				70	4	7,000	
HLRS 2020-05-040				RO.5				4	50	4	6,650
HLRS 2020-05-040E	○							4	50	4	7,320
HLRS 2020-05-060								6	50	4	6,650
HLRS 2020-05-060E	○							6	50	4	7,320
HLRS 2020-05-080			8					50	4	7,000	
HLRS 2020-05-080E	○		8					50	4	7,700	
HLRS 2020-05-100			10					50	4	7,000	
HLRS 2020-05-100E	○		10					50	4	7,700	
HLRS 2020-05-120			12					55	4	7,000	
HLRS 2020-05-120E	○		12					55	4	7,700	
HLRS 2020-05-160		16	60		4	7,000					
HLRS 2020-05-200		20	60		4	7,000					
HLRS 2020-05-260		26	70	4	7,000						
HLRS 2020-05-300		30	70	4	7,000						
HLRS 2025-01-100		2.5	RO.1	10	2.5	2.42	16°	50	4	7,340	
HLRS 2025-01-200				20				60	4	7,570	
HLRS 2025-01-300				30				70	4	7,800	
HLRS 2025-02-100			RO.2	10				50	4	7,340	
HLRS 2025-02-200				20				60	4	7,570	
HLRS 2025-02-300				30				70	4	7,800	
HLRS 2025-03-100			RO.3	10				50	4	7,340	
HLRS 2025-03-200				20				60	4	7,570	
HLRS 2025-03-300				30				70	4	7,800	
HLRS 2025-05-100			RO.5	10				50	4	7,340	
HLRS 2025-05-200				20				60	4	7,570	
HLRS 2025-05-300				30				70	4	7,800	

- UDC Series
- CBN Series
- Square
- Long Neck Square
- Radius
- Long Neck Radius
- Taper Neck Radius
- Ball / Long Shank Ball
- Long Neck Ball
- Taper Neck Ball
- Taper
- Spiral V Cutter
- Drill
- EURO Series
- Technical Data

Model Number	Excellent	Outside Diameter ϕD	Corner Radius CR	Effective Length l_1	Effective Length by Inclined Angles				
					30°	1°	1°30'	2°	3°
HLRS 2020-02-120		2	RO.2	12	12.40	12.81	13.23	13.69	14.71
HLRS 2020-02-120E	○			12	12.40	12.81	13.23	13.69	14.71
HLRS 2020-02-160				16	16.53	17.06	17.64	18.25	No Interference
HLRS 2020-02-200				20	20.66	21.32	22.04	22.80	No Interference
HLRS 2020-02-260				26	26.84	27.71	28.64	No Interference	No Interference
HLRS 2020-02-300				30	30.97	31.97	33.04	No Interference	No Interference
HLRS 2020-03-040			RO.3	4	4.15	4.28	4.42	4.57	4.91
HLRS 2020-03-040E	○			4	4.15	4.28	4.42	4.57	4.91
HLRS 2020-03-060				6	6.21	6.41	6.63	6.85	7.36
HLRS 2020-03-060E	○			6	6.21	6.41	6.63	6.85	7.36
HLRS 2020-03-080				8	8.28	8.54	8.83	9.13	9.80
HLRS 2020-03-080E	○			8	8.28	8.54	8.83	9.13	9.80
HLRS 2020-03-100				10	10.34	10.67	11.03	11.41	12.25
HLRS 2020-03-100E	○			10	10.34	10.67	11.03	11.41	12.25
HLRS 2020-03-120				12	12.40	12.80	13.23	13.68	14.70
HLRS 2020-03-120E	○			12	12.40	12.80	13.23	13.68	14.70
HLRS 2020-03-160				16	16.53	17.06	17.63	18.24	19.59
HLRS 2020-03-200				20	20.65	21.32	22.03	22.79	No Interference
HLRS 2020-03-260				26	26.84	27.71	28.64	No Interference	No Interference
HLRS 2020-03-300				30	30.97	31.97	33.04	No Interference	No Interference
HLRS 2020-05-040			RO.5	4	4.15	4.28	4.41	4.56	4.89
HLRS 2020-05-040E	○			4	4.15	4.28	4.41	4.56	4.89
HLRS 2020-05-060				6	6.21	6.41	6.62	6.84	7.34
HLRS 2020-05-060E	○			6	6.21	6.41	6.62	6.84	7.34
HLRS 2020-05-080				8	8.27	8.54	8.82	9.12	9.78
HLRS 2020-05-080E	○			8	8.27	8.54	8.82	9.12	9.78
HLRS 2020-05-100				10	10.34	10.67	11.02	11.39	12.23
HLRS 2020-05-100E	○			10	10.34	10.67	11.02	11.39	12.23
HLRS 2020-05-120				12	12.40	12.80	13.22	13.67	14.68
HLRS 2020-05-120E	○			12	12.40	12.80	13.22	13.67	14.68
HLRS 2020-05-160		16		16.53	17.06	17.62	18.23	19.57	
HLRS 2020-05-200		20		20.65	21.31	22.02	22.78	No Interference	
HLRS 2020-05-260		26		26.84	27.70	28.63	No Interference	No Interference	
HLRS 2020-05-300		30		30.97	31.96	33.03	No Interference	No Interference	
HLRS 2025-01-100		2.5	RO.1	10	10.34	10.68	11.04	11.42	12.27
HLRS 2025-01-200				20	20.66	21.33	22.04	No Interference	No Interference
HLRS 2025-01-300				30	30.97	31.98	No Interference	No Interference	No Interference
HLRS 2025-02-100			RO.2	10	10.34	10.68	11.03	11.41	12.26
HLRS 2025-02-200				20	20.66	21.32	22.04	No Interference	No Interference
HLRS 2025-02-300				30	30.97	31.97	No Interference	No Interference	No Interference
HLRS 2025-03-100			RO.3	10	10.34	10.67	11.03	11.41	12.25
HLRS 2025-03-200				20	20.65	21.32	22.03	No Interference	No Interference
HLRS 2025-03-300				30	30.97	31.97	No Interference	No Interference	No Interference
HLRS 2025-05-100			RO.5	10	10.34	10.67	11.02	11.39	12.23
HLRS 2025-05-200				20	20.65	21.31	22.02	No Interference	No Interference
HLRS 2025-05-300				30	30.97	31.96	No Interference	No Interference	No Interference

UDC Series

CBN Series

Square

Long Neck Square

Radius

Long Neck Radius

Taper Neck Radius

Ball / Long Shank Ball

Long Neck Ball

Taper Neck Ball

Taper

Spiral V Cutter

Drill

EURO Series

Technical Data

Unit (mm)

Model Number	Excellent	Outside Diameter ϕD	Corner Radius CR	Effective Length l_1	Length of Cut l	Neck Diameter ϕd_1	Shank Taper Angle Bta	Overall Length L	Shank Diameter ϕd	Price ¥	
HLRS 2030-01-060		3	RO.1	6	3	2.92	16°	55	6	6,000	
HLRS 2030-01-060E	○			6				6,600			
HLRS 2030-01-120				12				7,800			
HLRS 2030-01-160				16				9,100			
HLRS 2030-01-160E	○			16				10,010			
HLRS 2030-01-180				18				9,100			
HLRS 2030-01-200				20				9,100			
HLRS 2030-01-260				26				9,100			
HLRS 2030-01-300				30				9,100			
HLRS 2030-01-360				36				11,200			
HLRS 2030-02-060				RO.2				6	55	6	6,000
HLRS 2030-02-060E	○							6	55	6	6,600
HLRS 2030-02-120			12					55	6	7,800	
HLRS 2030-02-160			16					60	6	9,100	
HLRS 2030-02-160E	○		16					60	6	10,010	
HLRS 2030-02-180			18					60	6	9,100	
HLRS 2030-02-200			20					60	6	9,100	
HLRS 2030-02-260			26					70	6	9,100	
HLRS 2030-02-300			30					70	6	9,100	
HLRS 2030-02-360			36					80	6	11,200	
HLRS 2030-03-060			RO.3					6	55	6	6,000
HLRS 2030-03-060E	○							6	55	6	6,600
HLRS 2030-03-120				12				55	6	7,800	
HLRS 2030-03-160				16				60	6	9,100	
HLRS 2030-03-160E	○			16				60	6	10,010	
HLRS 2030-03-180				18				60	6	9,100	
HLRS 2030-03-200				20				60	6	9,100	
HLRS 2030-03-260				26				70	6	9,100	
HLRS 2030-03-300				30				70	6	9,100	
HLRS 2030-03-360				36				80	6	11,200	
HLRS 2030-05-060				RO.5				6	55	6	6,000
HLRS 2030-05-060E	○							6	55	6	6,600
HLRS 2030-05-120			12					55	6	7,800	
HLRS 2030-05-160			16					60	6	9,100	
HLRS 2030-05-160E	○		16					60	6	10,010	
HLRS 2030-05-180			18					60	6	9,100	
HLRS 2030-05-200		20	60		6	9,100					
HLRS 2030-05-260		26	70		6	9,100					
HLRS 2030-05-300		30	70		6	9,100					
HLRS 2030-05-360		36	80		6	11,200					

UDC Series

CBN Series

Square
Long Neck Square

Radius

Long Neck Radius
Taper Neck Radius

Ball / Long Shank Ball
Long Neck Ball
Taper Neck Ball

Taper

Spiral V Cutter

Drill

EURO Series

Technical Data

Model Number	Excellent	Outside Diameter ϕD	Corner Radius CR	Effective Length l_1	Effective Length by Inclined Angles					
					30°	1°	1°30'	2°	3°	
HLRS 2030-01-060		3	RO.1	6	6.21	6.42	6.63	6.86	7.37	
HLRS 2030-01-060E	○			6	6.21	6.42	6.63	6.86	7.37	
HLRS 2030-01-120				12	12.40	12.81	13.23	13.69	14.72	
HLRS 2030-01-160				16	16.53	17.06	17.64	18.25	19.61	
HLRS 2030-01-160E	○			16	16.53	17.06	17.64	18.25	19.61	
HLRS 2030-01-180				18	18.59	19.19	19.84	20.53	22.06	
HLRS 2030-01-200				20	20.65	21.32	22.04	22.80	24.51	
HLRS 2030-01-260				26	26.84	27.71	28.64	29.64	No Interference	
HLRS 2030-01-300				30	30.97	31.97	33.04	34.19	No Interference	
HLRS 2030-01-360				36	37.16	38.36	39.65	41.02	No Interference	
HLRS 2030-02-060				RO.2	6	6.21	6.41	6.63	6.85	7.36
HLRS 2030-02-060E	○				6	6.21	6.41	6.63	6.85	7.36
HLRS 2030-02-120			12		12.40	12.80	13.23	13.69	14.71	
HLRS 2030-02-160			16		16.53	17.06	17.63	18.24	19.60	
HLRS 2030-02-160E	○		16		16.53	17.06	17.63	18.24	19.60	
HLRS 2030-02-180			18		18.59	19.19	19.83	20.52	22.05	
HLRS 2030-02-200			20		20.65	21.32	22.03	22.80	24.49	
HLRS 2030-02-260			26		26.84	27.71	28.64	29.63	No Interference	
HLRS 2030-02-300			30		30.97	31.97	33.04	34.18	No Interference	
HLRS 2030-02-360			36		37.15	38.36	39.64	41.02	No Interference	
HLRS 2030-03-060			RO.3		6	6.21	6.41	6.62	6.85	7.35
HLRS 2030-03-060E	○				6	6.21	6.41	6.62	6.85	7.35
HLRS 2030-03-120				12	12.40	12.80	13.22	13.68	14.70	
HLRS 2030-03-160				16	16.53	17.06	17.63	18.23	19.59	
HLRS 2030-03-160E	○			16	16.53	17.06	17.63	18.23	19.59	
HLRS 2030-03-180				18	18.59	19.19	19.83	20.51	22.04	
HLRS 2030-03-200				20	20.65	21.32	22.03	22.79	24.48	
HLRS 2030-03-260				26	26.84	27.71	28.63	29.62	No Interference	
HLRS 2030-03-300				30	30.96	31.97	33.03	34.18	No Interference	
HLRS 2030-03-360				36	37.15	38.35	39.64	41.01	No Interference	
HLRS 2030-05-060				RO.5	6	6.21	6.40	6.61	6.83	7.33
HLRS 2030-05-060E	○				6	6.21	6.40	6.61	6.83	7.33
HLRS 2030-05-120			12		12.40	12.79	13.21	13.67	14.67	
HLRS 2030-05-160			16		16.52	17.05	17.62	18.22	19.57	
HLRS 2030-05-160E	○		16		16.52	17.05	17.62	18.22	19.57	
HLRS 2030-05-180			18		18.58	19.18	19.82	20.50	22.02	
HLRS 2030-05-200		20	20.65		21.31	22.02	22.78	24.46		
HLRS 2030-05-260		26	26.84		27.70	28.62	29.61	No Interference		
HLRS 2030-05-300		30	30.96		31.96	33.02	34.16	No Interference		
HLRS 2030-05-360		36	37.15		38.35	39.63	41.00	No Interference		

UDC Series

CBN Series

Square
Long Neck Square

Radius

Radius
Long Neck Radius
Taper Neck RadiusBall / Long Shank Ball
Long Neck Ball
Taper Neck Ball

Taper

Spiral V Cutter

Drill

EURO Series

Technical Data

Unit (mm)

Model Number	Excellent	Outside Diameter ϕD	Corner Radius CR	Effective Length l_1	Length of Cut l	Neck Diameter ϕd_1	Shank Taper Angle Bta	Overall Length L	Shank Diameter ϕd	Price ¥
HLRS 2030-10-060		3	R1	6	3	2.92	16°	55	6	6,000
HLRS 2030-10-060E	○			6				6,600		
HLRS 2030-10-120				12				7,800		
HLRS 2030-10-160				16				9,100		
HLRS 2030-10-160E	○			16				10,010		
HLRS 2030-10-180				18				9,100		
HLRS 2030-10-200				20				9,100		
HLRS 2030-10-260				26				9,100		
HLRS 2030-10-300				30				9,100		
HLRS 2030-10-360				36				11,200		
HLRS 2040-01-080		4	RO.1	8	4	3.82	16°	65	6	7,800
HLRS 2040-01-080E	○			8				8,580		
HLRS 2040-01-120				12				8,000		
HLRS 2040-01-160				16				9,400		
HLRS 2040-01-200				20				10,130		
HLRS 2040-01-200E	○			20				11,140		
HLRS 2040-01-240				24				10,130		
HLRS 2040-01-320				32				10,130		
HLRS 2040-01-480			48	16,200						
HLRS 2040-02-080			RO.2	8				65	6	7,800
HLRS 2040-02-080E	○			8				65	6	8,580
HLRS 2040-02-120				12				65	6	8,000
HLRS 2040-02-160				16				65	6	9,400
HLRS 2040-02-200				20				65	6	10,130
HLRS 2040-02-200E	○			20				65	6	11,140
HLRS 2040-02-240				24				65	6	10,130
HLRS 2040-02-320				32				65	6	10,130
HLRS 2040-02-480			48	65				6	16,200	
HLRS 2040-03-080			RO.3	8				65	6	7,800
HLRS 2040-03-080E	○			8				65	6	8,580
HLRS 2040-03-120				12				65	6	8,000
HLRS 2040-03-160				16				65	6	9,400
HLRS 2040-03-200				20				65	6	10,130
HLRS 2040-03-200E	○			20				65	6	11,140
HLRS 2040-03-240				24				65	6	10,130
HLRS 2040-03-320				32				65	6	10,130
HLRS 2040-03-480			48	65				6	16,200	
HLRS 2040-05-080			RO.5	8				65	6	7,800
HLRS 2040-05-080E	○	8		65	6	8,580				
HLRS 2040-05-120		12		65	6	8,000				
HLRS 2040-05-160		16		65	6	9,400				
HLRS 2040-05-200		20		65	6	10,130				
HLRS 2040-05-200E	○	20		65	6	11,140				
HLRS 2040-05-240		24		65	6	10,130				
HLRS 2040-05-320		32		65	6	10,130				
HLRS 2040-05-480		48	65	6	16,200					

- UDC Series
- CBN Series
- Square
- Long Neck Square
- Radius
- Long Neck Radius
- Taper Neck Radius
- Ball / Long Shank Ball
- Long Neck Ball
- Taper Neck Ball
- Taper
- Spiral V Cutter
- Drill
- EURO Series
- Technical Data

Model Number	Excellent	Outside Diameter ϕD	Corner Radius CR	Effective Length l_1	Effective Length by Inclined Angles				
					30°	1°	1°30'	2°	3°
HLRS 2030-10-060		3	R1	6	6.20	6.39	6.59	6.80	7.28
HLRS 2030-10-060E	○			6	6.20	6.39	6.59	6.80	7.28
HLRS 2030-10-120				12	12.39	12.78	13.19	13.63	14.62
HLRS 2030-10-160				16	16.51	17.04	17.59	18.19	19.52
HLRS 2030-10-160E	○			16	16.51	17.04	17.59	18.19	19.52
HLRS 2030-10-180				18	18.58	19.17	19.79	20.47	21.96
HLRS 2030-10-200				20	20.64	21.29	21.99	22.74	24.41
HLRS 2030-10-260				26	26.83	27.68	28.60	29.57	No Interference
HLRS 2030-10-300				30	30.95	31.94	33.00	34.13	No Interference
HLRS 2030-10-360				36	37.14	38.33	39.60	40.96	No Interference
HLRS 2040-01-080				4	RO.1	8	8.45	8.73	9.02
HLRS 2040-01-080E	○	8	8.45			8.73	9.02	9.33	10.03
HLRS 2040-01-120		12	12.58			12.99	13.42	13.89	14.92
HLRS 2040-01-160		16	16.70			17.25	17.82	18.44	No Interference
HLRS 2040-01-200		20	20.83			21.50	22.23	23.00	No Interference
HLRS 2040-01-200E	○	20	20.83			21.50	22.23	23.00	No Interference
HLRS 2040-01-240		24	24.95			25.76	26.63	27.55	No Interference
HLRS 2040-01-320		32	33.21			34.28	35.43	No Interference	No Interference
HLRS 2040-01-480		48	49.71		51.32	No Interference	No Interference	No Interference	
HLRS 2040-02-080		RO.2	8		8.45	8.72	9.01	9.33	10.02
HLRS 2040-02-080E	○		8		8.45	8.72	9.01	9.33	10.02
HLRS 2040-02-120			12		12.58	12.98	13.42	13.88	14.91
HLRS 2040-02-160			16		16.70	17.24	17.82	18.44	No Interference
HLRS 2040-02-200			20		20.83	21.50	22.22	22.99	No Interference
HLRS 2040-02-200E	○		20		20.83	21.50	22.22	22.99	No Interference
HLRS 2040-02-240			24		24.95	25.76	26.62	27.54	No Interference
HLRS 2040-02-320			32		33.20	34.28	35.43	No Interference	No Interference
HLRS 2040-02-480		48	49.71		51.32	No Interference	No Interference	No Interference	
HLRS 2040-03-080		RO.3	8		8.45	8.72	9.01	9.32	10.01
HLRS 2040-03-080E	○		8		8.45	8.72	9.01	9.32	10.01
HLRS 2040-03-120			12		12.58	12.98	13.41	13.87	14.69
HLRS 2040-03-160			16		16.70	17.24	17.81	18.43	No Interference
HLRS 2040-03-200			20		20.83	21.50	22.22	22.98	No Interference
HLRS 2040-03-200E	○		20		20.83	21.50	22.22	22.98	No Interference
HLRS 2040-03-240			24		24.95	25.76	26.62	27.54	No Interference
HLRS 2040-03-320			32		33.20	34.28	35.42	No Interference	No Interference
HLRS 2040-03-480		48	49.71		51.31	No Interference	No Interference	No Interference	
HLRS 2040-05-080		RO.5	8		8.45	8.71	9.00	9.31	9.99
HLRS 2040-05-080E	○		8		8.45	8.71	9.00	9.31	9.99
HLRS 2040-05-120			12		12.57	12.97	13.40	13.86	14.88
HLRS 2040-05-160			16		16.70	17.23	17.80	18.42	No Interference
HLRS 2040-05-200			20		20.82	21.49	22.21	22.97	No Interference
HLRS 2040-05-200E	○		20	20.82	21.49	22.21	22.97	No Interference	
HLRS 2040-05-240			24	24.95	25.75	26.61	27.52	No Interference	
HLRS 2040-05-320			32	33.20	34.27	35.41	No Interference	No Interference	
HLRS 2040-05-480		48	49.70	51.31	No Interference	No Interference	No Interference		

UDC Series

CBN Series

Square
Long Neck Square

Radius

Radius
Long Neck Radius
Taper Neck RadiusBall / Long Shank Ball
Long Neck BallTaper Neck Ball
Taper

Spiral V Cutter

Drill

EURO Series

Technical Data

Model Number	Excellent	Outside Diameter ϕD	Corner Radius CR	Effective Length l_1	Length of Cut l	Neck Diameter ϕd_1	Shank Taper Angle Bta	Overall Length L	Shank Diameter ϕd	Price ¥				
HLRS 2040-10-080		4	R1	8	4	3.82	16°	65	6	7,800				
HLRS 2040-10-080E	○			8				8,580						
HLRS 2040-10-120				12				8,000						
HLRS 2040-10-160				16				9,400						
HLRS 2040-10-200				20				10,130						
HLRS 2040-10-200E	○			20				11,140						
HLRS 2040-10-240				24				10,130						
HLRS 2040-10-320				32				10,130						
HLRS 2040-10-480				48				16,200						
HLRS 2050-02-200				5				RO.2	20	5	4.82	16°	70	6
HLRS 2050-02-400		40	16,200											
HLRS 2050-03-200		RO.3	20		70	6	12,900							
HLRS 2050-03-400			40		90	6	16,200							
HLRS 2050-05-200		RO.5	20		70	6	12,900							
HLRS 2050-05-400			40		90	6	16,200							
HLRS 2050-10-200		R1	20		70	6	12,900							
HLRS 2050-10-400			40		90	6	16,200							
HLRS 2060-01-120		6	RO.1		12	6	5.82	-	65				6	12,900
HLRS 2060-01-120E	○				12				65				6	14,190
HLRS 2060-01-200				20	70				6	12,900				
HLRS 2060-01-300				30	100				6	16,700				
HLRS 2060-01-300E	○			30	100				6	18,370				
HLRS 2060-01-600				60	120				6	20,300				
HLRS 2060-02-120				RO.2	12				65	6	12,900			
HLRS 2060-02-120E	○				12				65	6	14,190			
HLRS 2060-02-200					20				70	6	12,900			
HLRS 2060-02-300					30				100	6	16,700			
HLRS 2060-02-300E	○		30		100				6	18,370				
HLRS 2060-02-600			60		120				6	20,300				
HLRS 2060-03-120			RO.3	12	65				6	12,900				
HLRS 2060-03-120E	○			12	65				6	14,190				
HLRS 2060-03-200				20	70				6	12,900				
HLRS 2060-03-300				30	100				6	16,700				
HLRS 2060-03-300E	○			30	100				6	18,370				
HLRS 2060-03-600				60	120				6	20,300				
HLRS 2060-05-120				RO.5	12				65	6	12,900			
HLRS 2060-05-120E	○				12				65	6	14,190			
HLRS 2060-05-200					20				70	6	12,900			
HLRS 2060-05-300					30				100	6	16,700			
HLRS 2060-05-300E	○		30		100				6	18,370				
HLRS 2060-05-600			60		120				6	20,300				
HLRS 2060-10-120			R1		12				65	6	12,900			
HLRS 2060-10-120E	○				12				65	6	14,190			
HLRS 2060-10-200					20				70	6	12,900			
HLRS 2060-10-300					30				100	6	16,700			
HLRS 2060-10-300E	○			30	100				6	18,370				
HLRS 2060-10-600				60	120				6	20,300				

- UDC Series
- CBN Series
- Square
- Long Neck Square
- Radius
- Long Neck Radius
- Taper Neck Radius
- Ball / Long Shank Ball
- Long Neck Ball
- Taper Neck Ball
- Taper
- Spiral V Cutter
- Drill
- EURO Series
- Technical Data

Model Number	Excellent	Outside Diameter ϕD	Corner Radius CR	Effective Length l_1	Effective Length by Inclined Angles					
					30°	1°	1°30'	2°	3°	
HLRS 2040-10-080		4	R1	8	8.44	8.70	8.98	9.27	9.93	
HLRS 2040-10-080E	○			8	8.44	8.70	8.98	9.27	9.93	
HLRS 2040-10-120				12	12.56	12.96	13.38	13.83	14.83	
HLRS 2040-10-160				16	16.69	17.22	17.78	18.38	19.72	
HLRS 2040-10-200				20	20.82	21.48	22.18	22.94	No Interference	
HLRS 2040-10-200E	○			20	20.82	21.48	22.18	22.94	No Interference	
HLRS 2040-10-240				24	24.94	25.74	26.58	27.49	No Interference	
HLRS 2040-10-320				32	33.19	34.25	35.39	No Interference	No Interference	
HLRS 2040-10-480				48	49.69	51.29	No Interference	No Interference	No Interference	
HLRS 2050-02-200				5	RO.2	20	20.83	21.50	No Interference	No Interference
HLRS 2050-02-400		40	41.46			No Interference	No Interference	No Interference	No Interference	
HLRS 2050-03-200		RO.3	20		20.83	21.50	No Interference	No Interference	No Interference	
HLRS 2050-03-400			40		41.45	No Interference	No Interference	No Interference	No Interference	
HLRS 2050-05-200		RO.5	20		20.82	21.49	No Interference	No Interference	No Interference	
HLRS 2050-05-400			40		41.45	No Interference	No Interference	No Interference	No Interference	
HLRS 2050-10-200		R1	20		20.82	21.48	No Interference	No Interference	No Interference	
HLRS 2050-10-400			40		41.44	No Interference	No Interference	No Interference	No Interference	
HLRS 2060-01-120		6	RO.1		12	No Interference	No Interference	No Interference	No Interference	No Interference
HLRS 2060-01-120E	○				12	No Interference	No Interference	No Interference	No Interference	No Interference
HLRS 2060-01-200				20	No Interference	No Interference	No Interference	No Interference	No Interference	No Interference
HLRS 2060-01-300				30	No Interference	No Interference	No Interference	No Interference	No Interference	No Interference
HLRS 2060-01-300E	○			30	No Interference	No Interference	No Interference	No Interference	No Interference	No Interference
HLRS 2060-01-600				60	No Interference	No Interference	No Interference	No Interference	No Interference	No Interference
HLRS 2060-02-120			RO.2	12	No Interference	No Interference	No Interference	No Interference	No Interference	No Interference
HLRS 2060-02-120E	○			12	No Interference	No Interference	No Interference	No Interference	No Interference	No Interference
HLRS 2060-02-200				20	No Interference	No Interference	No Interference	No Interference	No Interference	No Interference
HLRS 2060-02-300				30	No Interference	No Interference	No Interference	No Interference	No Interference	No Interference
HLRS 2060-02-300E	○			30	No Interference	No Interference	No Interference	No Interference	No Interference	No Interference
HLRS 2060-02-600				60	No Interference	No Interference	No Interference	No Interference	No Interference	No Interference
HLRS 2060-03-120			RO.3	12	No Interference	No Interference	No Interference	No Interference	No Interference	No Interference
HLRS 2060-03-120E	○			12	No Interference	No Interference	No Interference	No Interference	No Interference	No Interference
HLRS 2060-03-200				20	No Interference	No Interference	No Interference	No Interference	No Interference	No Interference
HLRS 2060-03-300				30	No Interference	No Interference	No Interference	No Interference	No Interference	No Interference
HLRS 2060-03-300E	○			30	No Interference	No Interference	No Interference	No Interference	No Interference	No Interference
HLRS 2060-03-600				60	No Interference	No Interference	No Interference	No Interference	No Interference	No Interference
HLRS 2060-05-120		RO.5	12	No Interference	No Interference	No Interference	No Interference	No Interference	No Interference	
HLRS 2060-05-120E	○		12	No Interference	No Interference	No Interference	No Interference	No Interference	No Interference	
HLRS 2060-05-200			20	No Interference	No Interference	No Interference	No Interference	No Interference	No Interference	
HLRS 2060-05-300			30	No Interference	No Interference	No Interference	No Interference	No Interference	No Interference	
HLRS 2060-05-300E	○		30	No Interference	No Interference	No Interference	No Interference	No Interference	No Interference	
HLRS 2060-05-600			60	No Interference	No Interference	No Interference	No Interference	No Interference	No Interference	
HLRS 2060-10-120		R1	12	No Interference	No Interference	No Interference	No Interference	No Interference	No Interference	
HLRS 2060-10-120E	○		12	No Interference	No Interference	No Interference	No Interference	No Interference	No Interference	
HLRS 2060-10-200			20	No Interference	No Interference	No Interference	No Interference	No Interference	No Interference	
HLRS 2060-10-300			30	No Interference	No Interference	No Interference	No Interference	No Interference	No Interference	
HLRS 2060-10-300E	○		30	No Interference	No Interference	No Interference	No Interference	No Interference	No Interference	
HLRS 2060-10-600			60	No Interference	No Interference	No Interference	No Interference	No Interference	No Interference	

- UDC Series
- CBN Series
- Square
- Long Neck Square
- Radius
- Long Neck Radius
- Taper Neck Radius
- Ball / Long Shank Ball
- Long Neck Ball
- Taper Neck Ball
- Taper
- Spiral V Cutter
- Drill
- EURO Series
- Technical Data

Milling Conditions for HLRS (2 Flutes)

WORK MATERIAL			Copper OFC / TPC				PREHARDENED STEELS HARDENED STEELS NAK / SKD (30~45HRC)				HARDENED STEELS SKD / SKT (45~55HRC)				HARDENED STEELS SKD / SKH (55~65HRC)				
Model Number	Outside Diameter (mm)	Effective Length (mm)	Spindle Speed (min ⁻¹)	Feed Rate (mm/min)	a _p Axial Depth (mm)	a _e Radial Depth (mm)	Spindle Speed (min ⁻¹)	Feed Rate (mm/min)	a _p Axial Depth (mm)	a _e Radial Depth (mm)	Spindle Speed (min ⁻¹)	Feed Rate (mm/min)	a _p Axial Depth (mm)	a _e Radial Depth (mm)	Spindle Speed (min ⁻¹)	Feed Rate (mm/min)	a _p Axial Depth (mm)	a _e Radial Depth (mm)	
UDC Series	2002	0.2	0.5	55,000	230	0.027	0.02	55,000	230	0.006	0.02	44,800	236	0.005	0.02	19,000	30	0.002	0.015
			1	55,000	200	0.027	0.02	55,000	200	0.006	0.02	35,000	150	0.004	0.02	15,000	25	0.0015	0.015
			1.5	55,000	180	0.017	0.01	55,000	180	0.005	0.01	27,000	100	0.003	0.01	12,000	20	0.001	0.007
			2	55,000	170	0.007	0.005	55,000	170	0.003	0.005	20,000	60	0.002	0.005	10,500	15	0.001	0.003
CBN Series	2003	0.3	1	60,000	500	0.03	0.02	60,000	500	0.007	0.02	35,000	350	0.005	0.02	22,000	35	0.004	0.015
			1.5	60,000	470	0.03	0.02	60,000	470	0.007	0.02	35,000	310	0.005	0.018	22,000	33	0.004	0.015
			2	60,000	400	0.03	0.02	60,000	400	0.007	0.02	33,200	250	0.005	0.015	20,000	32	0.004	0.015
			2.5	57,000	330	0.03	0.017	57,000	330	0.007	0.017	30,000	180	0.003	0.012	18,000	30	0.002	0.012
Square	2004	0.4	3	52,000	220	0.03	0.015	52,000	220	0.006	0.015	25,000	80	0.003	0.01	15,000	20	0.002	0.01
			1	50,900	610	0.048	0.063	50,900	510	0.013	0.072	40,700	370	0.011	0.072	24,200	40	0.004	0.072
			1.5	45,200	580	0.045	0.063	45,200	480	0.012	0.054	36,200	360	0.01	0.054	21,500	38	0.004	0.054
			2	40,400	540	0.042	0.054	40,400	450	0.011	0.045	32,300	330	0.009	0.045	19,200	35	0.004	0.045
Long Neck Square	2005	0.5	3	33,900	460	0.027	0.054	33,900	390	0.008	0.027	27,100	280	0.007	0.027	16,100	30	0.003	0.027
			4	30,000	220	0.01	0.045	30,000	340	0.006	0.014	24,000	250	0.005	0.014	14,300	27	0.002	0.014
			1	49,200	1,370	0.081	0.117	49,200	1,140	0.034	0.122	40,000	860	0.03	0.122	24,800	94	0.013	0.122
			2	39,900	1,000	0.075	0.108	39,900	830	0.029	0.117	32,500	630	0.026	0.117	20,100	68	0.011	0.117
Radius	2006	0.6	3	31,900	770	0.057	0.09	31,900	640	0.023	0.113	26,000	480	0.02	0.113	16,100	52	0.008	0.113
			4	29,100	660	0.039	0.072	29,100	550	0.016	0.108	23,700	410	0.014	0.108	14,600	45	0.006	0.108
			5	26,400	570	0.027	0.045	26,400	470	0.011	0.099	21,500	360	0.01	0.099	13,300	39	0.004	0.099
			6	24,200	480	0.021	0.018	24,200	400	0.007	0.09	19,700	300	0.006	0.09	12,200	33	0.003	0.09
Long Neck Radius	2007	0.7	2	28,600	610	0.114	0.162	28,600	510	0.01	0.219	23,700	390	0.01	0.219	15,200	43	0.004	0.219
			3	23,800	480	0.09	0.135	23,800	400	0.008	0.108	19,700	300	0.007	0.108	12,600	33	0.003	0.108
			4	20,400	400	0.063	0.108	20,400	330	0.005	0.104	16,800	250	0.005	0.104	10,800	28	0.002	0.104
			6	16,800	300	0.036	0.045	16,800	250	0.003	0.099	13,900	190	0.003	0.099	8,900	21	0.001	0.099
Ball / Long Shank Ball	2008	0.8	8	14,600	240	0.021	0.027	14,600	200	0.002	0.072	12,100	150	0.002	0.072	7,700	16	0.001	0.072
			4	18,400	480	0.087	0.162	18,400	400	0.008	0.117	15,500	310	0.008	0.117	10,200	35	0.004	0.117
			6	15,400	360	0.051	0.108	15,400	300	0.005	0.108	13,000	230	0.005	0.108	8,600	26	0.002	0.108
			4	17,500	540	0.132	0.198	17,500	450	0.014	0.117	15,000	360	0.015	0.117	10,200	41	0.007	0.117
Long Neck Ball	2009	1	6	14,600	410	0.075	0.144	14,600	340	0.008	0.108	12,500	270	0.008	0.108	8,500	30	0.004	0.108
			8	12,800	310	0.03	0.1	12,800	270	0.005	0.09	11,000	185	0.004	0.09	7,600	20	0.002	0.09
			2	17,600	1,100	0.21	0.45	17,600	920	0.035	0.27	15,300	750	0.04	0.27	10,900	89	0.02	0.27
			3	15,500	1,050	0.205	0.425	15,500	870	0.031	0.27	13,200	720	0.037	0.27	9,400	86	0.018	0.27
Taper Neck Ball	2010	1	4	13,800	980	0.201	0.405	13,800	820	0.03	0.27	12,000	670	0.035	0.27	8,500	80	0.017	0.27
			5	12,500	900	0.16	0.4	12,500	720	0.025	0.24	11,000	600	0.03	0.24	7,800	72	0.015	0.24
			6	11,300	790	0.117	0.387	11,300	650	0.021	0.216	9,800	540	0.024	0.216	7,000	64	0.012	0.216
			8	9,800	590	0.072	0.36	9,800	490	0.016	0.189	8,500	400	0.018	0.189	6,100	48	0.009	0.189
Taper	2011	1	10	8,800	390	0.048	0.315	8,800	320	0.011	0.126	7,600	270	0.013	0.126	5,400	32	0.006	0.126
			12	8,100	260	0.033	0.27	8,100	210	0.008	0.072	7,000	180	0.009	0.072	5,000	21	0.004	0.072
			16	7,000	230	0.018	0.225	7,000	190	0.004	0.027	6,100	160	0.005	0.027	4,300	19	0.002	0.027
			20	6,300	160	0.015	0.18	6,300	130	0.003	0.018	5,500	110	0.003	0.018	3,900	13	0.001	0.018

Milling Conditions for HLRS (2 Flutes)

WORK MATERIAL			Copper OFC / TPC				PREHARDENED STEELS HARDENED STEELS NAK / SKD (30~45HRC)				HARDENED STEELS SKD / SKT (45~55HRC)				HARDENED STEELS SKD / SKH (55~65HRC)			
Model Number	Outside Diameter (mm)	Effective Length (mm)	Spindle Speed (min ⁻¹)	Feed Rate (mm/min)	a _p Axial Depth (mm)	a _e Radial Depth (mm)	Spindle Speed (min ⁻¹)	Feed Rate (mm/min)	a _p Axial Depth (mm)	a _e Radial Depth (mm)	Spindle Speed (min ⁻¹)	Feed Rate (mm/min)	a _p Axial Depth (mm)	a _e Radial Depth (mm)	Spindle Speed (min ⁻¹)	Feed Rate (mm/min)	a _p Axial Depth (mm)	a _e Radial Depth (mm)
2012	1.2	6	9,400	700	0.186	0.468	9,400	580	0.018	0.09	8,400	490	0.022	0.09	6,200	60	0.011	0.09
		12	6,800	440	0.054	0.405	6,800	370	0.007	0.072	6,100	310	0.008	0.072	4,500	38	0.004	0.072
		20	5,400	250	0.021	0.24	5,400	210	0.003	0.018	4,800	180	0.003	0.018	3,500	22	0.002	0.018
2015	1.5	4	13,200	1,310	0.3	0.675	13,200	1,090	0.045	0.45	12,000	950	0.06	0.45	9,200	124	0.033	0.45
		6	10,600	1,240	0.282	0.63	10,600	1,030	0.041	0.405	9,700	900	0.055	0.405	7,400	117	0.03	0.405
		8	9,300	1,050	0.204	0.612	9,300	870	0.034	0.315	8,500	760	0.045	0.315	6,500	99	0.025	0.315
		10	8,500	900	0.15	0.567	8,500	750	0.032	0.288	7,800	650	0.042	0.288	6,000	85	0.023	0.288
		12	7,800	800	0.114	0.54	7,800	670	0.029	0.27	7,100	580	0.038	0.27	5,400	76	0.021	0.27
		16	6,800	620	0.066	0.45	6,800	510	0.015	0.18	6,200	450	0.02	0.18	4,700	58	0.011	0.18
		20	6,000	490	0.042	0.36	6,000	410	0.005	0.108	5,500	360	0.006	0.108	4,200	46	0.003	0.108
2020	2	4	15,300	1,500	0.33	0.9	15,300	1,250	0.046	0.9	14,300	1,130	0.065	0.9	11,500	162	0.039	0.9
		6	12,800	1,220	0.321	0.855	12,800	1,020	0.043	0.81	12,000	930	0.06	0.81	9,700	133	0.036	0.81
		8	11,200	1,120	0.267	0.81	11,200	930	0.039	0.72	10,400	850	0.055	0.72	8,400	121	0.033	0.72
		10	10,000	1,050	0.225	0.765	10,000	870	0.033	0.585	9,300	790	0.047	0.585	7,600	113	0.028	0.585
		12	9,100	980	0.186	0.72	9,100	820	0.031	0.45	8,500	740	0.044	0.45	6,900	107	0.026	0.45
		16	7,800	830	0.132	0.702	7,800	690	0.028	0.315	7,300	630	0.039	0.315	5,900	90	0.023	0.315
		20	7,000	770	0.093	0.666	7,000	640	0.017	0.198	6,600	580	0.024	0.198	5,300	84	0.014	0.198
		26	6,200	700	0.06	0.54	6,200	580	0.006	0.144	5,800	530	0.008	0.144	4,600	75	0.005	0.144
		30	6,000	670	0.05	0.45	6,000	550	0.005	0.135	5,500	500	0.005	0.135	4,400	70	0.002	0.135
2025	2.5	10	10,500	1,220	0.339	0.855	10,500	1,020	0.052	0.54	10,000	960	0.075	0.54	8,400	154	0.048	0.54
		20	7,800	720	0.165	0.756	7,800	600	0.024	0.225	7,500	560	0.035	0.225	6,300	91	0.022	0.225
		30	6,300	540	0.069	0.63	6,300	450	0.011	0.18	6,000	420	0.016	0.18	5,000	67	0.01	0.18
2030	3	6	14,000	2,700	0.5	0.9	14,000	1,510	0.15	0.72	13,300	1,140	0.15	0.72	12,000	270	0.1	0.72
		12	10,500	1,600	0.39	0.85	10,500	1,150	0.105	0.67	10,000	890	0.105	0.67	9,000	200	0.075	0.67
		16	9,200	1,160	0.321	0.81	9,200	960	0.081	0.63	8,800	730	0.081	0.63	7,900	173	0.054	0.63
		18	8,800	1,100	0.29	0.79	8,800	900	0.078	0.6	8,300	700	0.078	0.6	7,500	160	0.048	0.6
		20	8,400	1,050	0.26	0.78	8,400	880	0.073	0.58	7,900	680	0.073	0.58	7,100	150	0.044	0.58
		26	7,500	980	0.18	0.72	7,500	820	0.065	0.495	7,100	620	0.065	0.495	6,400	146	0.043	0.495
		30	7,000	870	0.14	0.69	7,000	720	0.05	0.38	6,500	560	0.05	0.38	6,000	118	0.029	0.38
		36	6,400	710	0.09	0.63	6,400	590	0.022	0.18	6,100	440	0.022	0.18	5,500	105	0.014	0.18
2040	4	8	10,200	1,340	0.42	1.62	10,200	1,110	0.095	1.35	8,500	970	0.14	1.35	7,300	223	0.101	1.35
		12	8,900	1,300	0.41	1.56	8,900	1,080	0.083	1.15	7,600	950	0.12	1.15	6,400	215	0.085	1.15
		16	7,900	1,250	0.4	1.5	7,900	1,030	0.065	1	6,600	910	0.1	1	5,600	205	0.065	1
		20	6,900	1,190	0.384	1.44	6,900	990	0.054	0.9	5,800	860	0.08	0.9	4,900	198	0.058	0.9
		24	6,200	1,100	0.31	1.38	6,200	900	0.043	0.8	5,200	770	0.065	0.8	4,500	175	0.043	0.8
		32	5,500	860	0.189	1.26	5,500	720	0.027	0.648	4,600	630	0.04	0.648	3,900	144	0.029	0.648
		48	4,600	430	0.093	1.08	4,600	360	0.007	0.315	3,900	310	0.01	0.315	3,300	72	0.007	0.315

UDC Series

CBN Series

Square

Long Neck Square

Radius

Long Neck Radius

Taper Neck Radius

Ball / Long Shank Ball

Long Neck Ball

Taper Neck Ball

Taper

Spiral V Cutter

Drill

EURO Series

Technical Data

Milling Conditions for HLRS (2 Flutes)

WORK MATERIAL			Copper OFC / TPC				PREHARDENED STEELS HARDENED STEELS NAK / SKD (30~45HRC)				HARDENED STEELS SKD / SKT (45~55HRC)				HARDENED STEELS SKD / SKH (55~65HRC)			
Model Number	Outside Diameter (mm)	Effective Length (mm)	Spindle Speed (min ⁻¹)	Feed Rate (mm/min)	a_p Axial Depth (mm)	a_e Radial Depth (mm)	Spindle Speed (min ⁻¹)	Feed Rate (mm/min)	a_p Axial Depth (mm)	a_e Radial Depth (mm)	Spindle Speed (min ⁻¹)	Feed Rate (mm/min)	a_p Axial Depth (mm)	a_e Radial Depth (mm)	Spindle Speed (min ⁻¹)	Feed Rate (mm/min)	a_p Axial Depth (mm)	a_e Radial Depth (mm)
2050	5	20	6,700	1,780	0.606	1.98	6,700	1,480	0.092	1.17	4,800	990	0.13	1.17	4,000	297	0.096	1.17
		40	4,600	850	0.297	1.53	4,600	710	0.046	0.9	3,300	470	0.065	0.9	2,800	143	0.048	0.9
2060	6	12	8,000	1,800	0.6	2.25	8,000	1,620	0.5	1.35	4,700	1,360	0.2	1.35	4,000	540	0.15	1.35
		20	5,800	1,350	0.58	2.12	5,800	1,180	0.46	1.31	3,500	1,000	0.18	1.31	3,000	380	0.14	1.31
		30	4,500	1,060	0.546	1.98	4,500	880	0.396	1.26	2,600	740	0.158	1.26	2,200	294	0.119	1.26
		60	2,800	530	0.156	1.62	2,800	440	0.113	0.99	1,600	370	0.045	0.99	1,400	147	0.034	0.99

Side Milling

a_p : Axial Depth (mm)
 a_e : Radial Depth (mm)

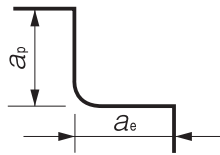

Note:

- Decrease both spindle speed and feed rate proportionally when the milling parameters exceed the machine's maximum spindle speed.
- Every coolant offers stable milling.
- Recommend oil coolant for Stainless Steels and Heat Resistant Alloys.
- Recommend wet coolant for Copper.

UDC Series

CBN Series

Square
Long Neck Square

Radius
Long Neck Radius

Taper Neck Radius

Ball / Long Shank Ball
Long Neck Ball
Taper Neck Ball

Taper

Spiral V Cutter

Drill

EURO Series

Technical Data

UDC Series

CBN Series

Square

Square

Long Neck Square

Radius

Radius

Long Neck Radius

Taper Neck Radius

Ball

Ball / Long Shank Ball

Long Neck Ball

Taper Neck Ball

Taper

Taper

Spiral V Cutter

Spiral V Cutter

Drill

Drill

EURO Series

EURO Series

Technical Data

Technical Data



Size $\phi 0.2 \sim \phi 6$

HLRS4000

Additional 42 models



Material Applications (☆ Highly Recommended ○ Recommended ○ Suggested)

Work Material															
Carbon Steels	Alloy Steels	Prehardened Steels	Hardened Steels			Cast Iron	Aluminum Alloys	Graphite	Copper	Plastics	Glass Filled Plastics	Titanium Alloys	Heat Resistant Alloys	Cemented Carbide	Hard Brittle (Non-Metallic) Materials
S45C S55C	SK / SCM SUS	NAK HPM	~55HRC	~60HRC	~70HRC										
○	○	○	○	○	○	○			○			○	○		

Total 381 models

Unit (mm)

Model Number	Outside Diameter ϕD	Corner Radius CR	Effective Length ℓ_1	Length of Cut ℓ	Neck Diameter ϕd_1	Shank Taper Angle Bta	Overall Length L	Shank Diameter ϕd	Price ¥	
HLRS 4002-002-003	0.2	R0.02	0.3	0.12	0.185	16°	50	4	14,100	
HLRS 4002-002-005			0.5				50	4	14,100	
HLRS 4002-002-010			1				50	4	14,100	
※ HLRS 4002-002-015			1.5				50	4	16,590	
※ HLRS 4002-002-020			2				50	4	18,150	
※ HLRS 4002-005-003			R0.05				0.3	50	4	14,100
※ HLRS 4003-002-003	0.3	R0.02	0.3	0.18	0.28	16°	50	4	14,100	
HLRS 4003-002-005			0.5				50	4	14,100	
HLRS 4003-002-010			1				50	4	14,100	
※ HLRS 4003-002-015			1.5				50	4	14,100	
※ HLRS 4003-002-020			2				50	4	14,100	
※ HLRS 4003-005-003			R0.05				0.3	50	4	14,100
HLRS 4003-005-005			0.5				50	4	14,100	
HLRS 4004-002-005	0.4	R0.02	0.5	0.24	0.385	16°	50	4	9,050	
HLRS 4004-002-010			1				50	4	9,050	
HLRS 4004-002-020			2				50	4	9,050	
HLRS 4004-005-005			0.5				50	4	9,050	
※ HLRS 4004-005-010			R0.05				1	50	4	9,050
※ HLRS 4004-005-015			1.5				50	4	9,050	
※ HLRS 4004-005-020		2	50				4	9,050		
HLRS 4004-01-010		R0.1	1				50	4	9,050	
HLRS 4004-01-020			2				50	4	9,050	

※Additional model

Next Page ➔

- UDC Series
- CBN Series
- Square
- Long Neck Square
- Radius
- Long Neck Radius
- Taper Neck Radius
- Ball / Long Shank Ball
- Long Neck Ball
- Taper Neck Ball
- Taper
- Spiral V Cutter
- Drill
- EURO Series
- Technical Data

Features

Long Neck Radius design for high efficiency and high quality milling.
 The rigid tool geometry offers longer tool life when milling Hard Materials.
 HARDMAX coat is adopted which maintains heat resistance, toughness and lubricity at a high level.
 Both dry and wet coolant offer stable and long tool life.
 Refer to page 318 for 2 flute HLRS.

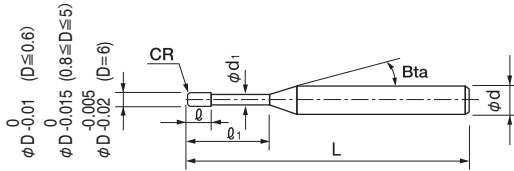
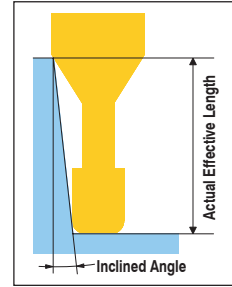

The shank taper angle shown is not an exact value and to avoid contact with the work piece, we recommend the user controls the precise value of this angle. Shank taper angle should not make contact with the work piece.

Unit (mm)

Model Number	Outside Diameter ϕD	Corner Radius CR	Effective Length ℓ_1	Effective Length by Inclined Angles				
				30'	1°	1°30'	2°	3°
HLRS 4002-002-003	0.2	RO.02	0.3	0.39	0.41	0.44	0.46	0.51
HLRS 4002-002-005			0.5	0.60	0.63	0.67	0.70	0.75
HLRS 4002-002-010			1	1.13	1.18	1.22	1.27	1.36
HLRS 4002-002-015			1.5	1.65	1.71	1.77	1.84	1.98
HLRS 4002-002-020			2	2.17	2.25	2.32	2.41	2.59
HLRS 4002-005-003			RO.05	0.3	0.39	0.41	0.43	0.46
HLRS 4003-002-003	0.3	RO.02	0.3	0.41	0.43	0.46	0.48	0.52
HLRS 4003-002-005			0.5	0.62	0.65	0.68	0.71	0.77
HLRS 4003-002-010			1	1.15	1.19	1.24	1.28	1.38
HLRS 4003-002-015			1.5	1.67	1.73	1.79	1.85	1.99
HLRS 4003-002-020			2	2.19	2.26	2.34	2.42	2.60
HLRS 4003-005-003			RO.05	0.3	0.41	0.43	0.45	0.47
HLRS 4003-005-005	0.5	0.62	0.65	0.68	0.71	0.76		
HLRS 4004-002-005	0.4	RO.02	0.5	0.62	0.65	0.68	0.71	0.77
HLRS 4004-002-010			1	1.15	1.19	1.24	1.28	1.38
HLRS 4004-002-020			2	2.17	2.25	2.33	2.41	2.59
HLRS 4004-005-005			0.5	0.62	0.65	0.68	0.71	0.76
HLRS 4004-005-010		RO.05	1	1.14	1.19	1.23	1.28	1.37
HLRS 4004-005-015			1.5	1.65	1.72	1.77	1.84	1.97
HLRS 4004-005-020			2	2.17	2.25	2.32	2.41	2.59
HLRS 4004-01-010			RO.1	1	1.14	1.19	1.23	1.27
HLRS 4004-01-020		2		2.17	2.25	2.32	2.40	2.57

Next Page →

4 Flutes

UDC Series

CBN Series

Square
Long Neck Square

Radius

Long Neck Radius

Taper Neck Radius

Ball / Long Shank Ball

Long Neck Ball

Taper Neck Ball

Taper

Spiral V Cutter

Drill

EURO Series

Technical Data

Model Number	Outside Diameter ϕD	Corner Radius CR	Effective Length ℓ_1	Length of Cut ℓ	Neck Diameter ϕd_1	Shank Taper Angle Bta	Overall Length L	Shank Diameter ϕd	Price ¥	
HLRS 4005-002-010	0.5	R0.02	1	0.3	0.485	16°	50	4	7,370	
HLRS 4005-002-020			2				50	4	7,370	
HLRS 4005-005-010		R0.05	1				50	4	7,370	
HLRS 4005-005-020			2				50	4	7,370	
HLRS 4005-01-010		R0.1	1				50	4	7,370	
HLRS 4005-01-020			2				50	4	7,370	
HLRS 4006-005-020	0.6	R0.05	2	0.36	0.585	16°	50	4	7,370	
HLRS 4006-005-040			4				50	4	7,370	
HLRS 4006-01-020		R0.1	2				50	4	7,370	
HLRS 4006-01-040			4				50	4	7,370	
HLRS 4008-002-020	0.8	R0.02	2	0.48	0.78	16°	50	4	8,100	
HLRS 4008-002-030			3				50	4	8,100	
HLRS 4008-002-040			4				50	4	8,400	
HLRS 4008-002-060			6				50	4	8,400	
HLRS 4008-002-080			8				50	4	8,400	
HLRS 4008-005-020			R0.05				2	50	4	8,100
HLRS 4008-005-030		3					50	4	8,100	
HLRS 4008-005-040		4					50	4	8,400	
HLRS 4008-005-060		6					50	4	8,400	
HLRS 4008-01-020		R0.1					2	50	4	8,100
HLRS 4008-01-030							3	50	4	8,100
HLRS 4008-01-040			4				50	4	8,400	
HLRS 4008-01-060			6				50	4	8,400	
HLRS 4008-02-020			R0.2				2	50	4	8,100
HLRS 4008-02-030							3	50	4	8,100
HLRS 4008-02-040		4					50	4	8,400	
HLRS 4008-02-060		6					50	4	8,400	
HLRS 4010-002-020		1					R0.02	2	0.8	0.95
HLRS 4010-002-030	3			50	4	7,400				
HLRS 4010-002-040	4		50	4	7,400					
HLRS 4010-002-050	5		50	4	8,100					
HLRS 4010-002-060	6		50	4	8,100					
HLRS 4010-002-080	8		50	4	8,100					
HLRS 4010-002-100	10		50	4	8,100					
HLRS 4010-002-120	12		55	4	8,100					
HLRS 4010-005-020	R0.05		2	50	4	7,400				
HLRS 4010-005-030			3	50	4	7,400				
HLRS 4010-005-040			4	50	4	7,400				
HLRS 4010-005-040			4	50	4	7,400				

UDC Series

CBN Series

Square
Long Neck Square

Radius
Long Neck Radius
Taper Neck Radius

Ball / Long Shank Ball
Long Neck Ball
Taper Neck Ball

Taper

Spiral V Cutter

Drill

EURO Series

Technical Data

Model Number	Outside Diameter ϕD	Corner Radius CR	Effective Length l_1	Effective Length by Inclined Angles					
				30'	1°	1°30'	2°	3°	
HLRS 4005-002-010	0.5	RO.02	1	1.15	1.19	1.24	1.28	1.38	
HLRS 4005-002-020			2	2.17	2.25	2.33	2.41	2.59	
HLRS 4005-005-010		RO.05	1	1.14	1.19	1.23	1.28	1.37	
HLRS 4005-005-020			2	2.17	2.25	2.32	2.41	2.59	
HLRS 4005-01-010		RO.1	1	1.14	1.19	1.23	1.27	1.36	
HLRS 4005-01-020			2	2.17	2.25	2.32	2.40	2.57	
HLRS 4006-005-020	0.6	RO.05	2	2.17	2.25	2.32	2.41	2.59	
HLRS 4006-005-040			4	4.24	4.38	4.53	4.68	5.03	
HLRS 4006-01-020		RO.1	2	2.17	2.25	2.32	2.40	2.57	
HLRS 4006-01-040			4	4.24	4.38	4.52	4.68	5.02	
HLRS 4008-002-020	0.8	RO.02	2	2.51	2.70	2.87	3.02	3.29	
HLRS 4008-002-030			3	3.59	3.82	4.02	4.19	4.51	
HLRS 4008-002-040			4	4.66	4.92	5.14	5.34	5.74	
HLRS 4008-002-060			6	6.78	7.10	7.36	7.61	8.19	
HLRS 4008-002-080		8	8.88	9.25	9.56	9.89	10.63		
HLRS 4008-005-020		RO.05	2	2.51	2.70	2.86	3.01	3.28	
HLRS 4008-005-030			3	3.59	3.82	4.01	4.19	4.51	
HLRS 4008-005-040			4	4.66	4.92	5.14	5.33	5.73	
HLRS 4008-005-060			6	6.77	7.09	7.35	7.61	8.18	
HLRS 4008-01-020		RO.1	2	2.51	2.69	2.86	3.00	3.27	
HLRS 4008-01-030			3	3.58	3.81	4.01	4.18	4.50	
HLRS 4008-01-040			4	4.65	4.92	5.13	5.33	5.72	
HLRS 4008-01-060			6	6.77	7.09	7.35	7.60	8.17	
HLRS 4008-02-020		RO.2	2	2.49	2.68	2.84	2.98	3.25	
HLRS 4008-02-030			3	3.57	3.80	3.99	4.16	4.47	
HLRS 4008-02-040			4	4.64	4.90	5.12	5.31	5.70	
HLRS 4008-02-060			6	6.76	7.08	7.34	7.59	8.14	
HLRS 4010-002-020		1	RO.02	2	2.57	2.75	2.90	3.05	3.32
HLRS 4010-002-030				3	3.64	3.86	4.05	4.22	4.54
HLRS 4010-002-040				4	4.70	4.96	5.17	5.36	5.76
HLRS 4010-002-050	5			5.76	6.04	6.28	6.50	6.99	
HLRS 4010-002-060	6			6.81	7.12	7.38	7.64	8.21	
HLRS 4010-002-080	8			8.91	9.27	9.58	9.92	10.66	
HLRS 4010-002-100	10			11.00	11.40	11.78	12.19	13.11	
HLRS 4010-002-120	12			13.08	13.53	13.98	14.47	15.55	
HLRS 4010-005-020	RO.05		2	2.56	2.74	2.90	3.05	3.31	
HLRS 4010-005-030			3	3.63	3.85	4.04	4.21	4.53	
HLRS 4010-005-040			4	4.70	4.95	5.17	5.36	5.76	

Model Number	Outside Diameter ϕD	Corner Radius CR	Effective Length ℓ_1	Length of Cut ℓ	Neck Diameter ϕd_1	Shank Taper Angle Bta	Overall Length L	Shank Diameter ϕd	Price ¥	
HLRS 4010-005-050	1	RO.05	5	0.8	0.95	16°	50	4	8,100	
HLRS 4010-005-060			6				50	4	8,100	
HLRS 4010-005-080			8				50	4	8,100	
HLRS 4010-005-100			10				50	4	8,100	
※ HLRS 4010-005-120			12				55	4	8,100	
HLRS 4010-01-020			RO.1				2	50	4	7,400
HLRS 4010-01-030		3					50	4	7,400	
HLRS 4010-01-040		4					50	4	7,400	
HLRS 4010-01-050		5					50	4	8,100	
HLRS 4010-01-060		6					50	4	8,100	
HLRS 4010-01-080		8					50	4	8,100	
HLRS 4010-01-100		10					50	4	8,100	
※ HLRS 4010-01-120		12					55	4	8,100	
HLRS 4010-02-020		RO.2					2	50	4	7,400
HLRS 4010-02-030							3	50	4	7,400
HLRS 4010-02-040			4				50	4	7,400	
HLRS 4010-02-050			5				50	4	8,100	
HLRS 4010-02-060			6				50	4	8,100	
HLRS 4010-02-080			8				50	4	8,100	
HLRS 4010-02-100			10				50	4	8,100	
※ HLRS 4010-02-120			12				55	4	8,100	
HLRS 4010-03-020			RO.3				2	50	4	7,400
HLRS 4010-03-030							3	50	4	7,400
HLRS 4010-03-040		4					50	4	7,400	
HLRS 4010-03-050	5	50		4	8,100					
HLRS 4010-03-060	6	50		4	8,100					
HLRS 4010-03-080	8	50		4	8,100					
HLRS 4010-03-100	10	50		4	8,100					
※ HLRS 4010-03-120	12	55		4	8,100					
※ HLRS 4010-03-160	16	60		4	10,740					
HLRS 4012-01-040	1.2	RO.1		4	0.96	1.14	16°	50	4	8,400
HLRS 4012-01-060			6	50				4	8,400	
HLRS 4012-01-100			10	50				4	8,400	
HLRS 4012-02-040		RO.2	4	50				4	8,400	
HLRS 4012-02-060			6	50				4	8,400	
HLRS 4012-02-100			10	50				4	8,400	
HLRS 4012-03-040		RO.3	4	50				4	8,400	
HLRS 4012-03-060			6	50				4	8,400	
HLRS 4012-03-100			10	50				4	8,400	
HLRS 4012-03-100			10	50				4	8,400	

※Additional model

UDC Series

CBN Series

Square
Long Neck Square

Radius
Long Neck Radius
Taper Neck Radius

Ball / Long Shank Ball
Long Neck Ball
Taper Neck Ball

Taper

Spiral V Cutter

Drill

EURO Series

Technical Data

Model Number	Outside Diameter ϕD	Corner Radius CR	Effective Length l_1	Effective Length by Inclined Angles					
				30'	1°	1°30'	2°	3°	
HLRS 4010-005-050	1	RO.05	5	5.76	6.04	6.28	6.50	6.98	
HLRS 4010-005-060			6	6.81	7.12	7.38	7.63	8.20	
HLRS 4010-005-080			8	8.91	9.27	9.58	9.91	10.65	
HLRS 4010-005-100			10	11.00	11.40	11.78	12.19	13.10	
HLRS 4010-005-120			12	13.08	13.53	13.98	14.47	15.55	
HLRS 4010-01-020		RO.1	2	2.56	2.74	2.89	3.04	3.30	
HLRS 4010-01-030			3	3.63	3.85	4.04	4.20	4.52	
HLRS 4010-01-040			4	4.70	4.95	5.16	5.35	5.75	
HLRS 4010-01-050			5	5.75	6.04	6.27	6.49	6.97	
HLRS 4010-01-060			6	6.81	7.12	7.37	7.63	8.19	
HLRS 4010-01-080		RO.1	8	8.91	9.26	9.57	9.90	10.64	
HLRS 4010-01-100			10	11.00	11.39	11.77	12.18	13.09	
HLRS 4010-01-120			12	13.08	13.52	13.98	14.46	15.54	
HLRS 4010-02-020			RO.2	2	2.55	2.72	2.88	3.02	3.28
HLRS 4010-02-030				3	3.62	3.84	4.02	4.19	4.50
HLRS 4010-02-040		4		4.69	4.94	5.15	5.34	5.72	
HLRS 4010-02-050		5		5.75	6.03	6.26	6.47	6.95	
HLRS 4010-02-060		6		6.80	7.11	7.36	7.61	8.17	
HLRS 4010-02-080		RO.2	8	8.90	9.26	9.56	9.89	10.62	
HLRS 4010-02-100			10	10.99	11.39	11.76	12.17	13.07	
HLRS 4010-02-120			12	13.07	13.52	13.97	14.45	15.51	
HLRS 4010-03-020			RO.3	2	2.54	2.71	2.86	3.00	3.25
HLRS 4010-03-030				3	3.62	3.83	4.01	4.17	4.48
HLRS 4010-03-040		4		4.68	4.93	5.14	5.32	5.70	
HLRS 4010-03-050		5		5.74	6.02	6.25	6.46	6.93	
HLRS 4010-03-060		6		6.80	7.10	7.35	7.60	8.15	
HLRS 4010-03-080		RO.3	8	8.90	9.25	9.55	9.88	10.60	
HLRS 4010-03-100			10	10.99	11.38	11.75	12.15	13.04	
HLRS 4010-03-120			12	13.07	13.51	13.96	14.43	15.49	
HLRS 4010-03-160			16	17.22	17.77	18.36	18.99	20.39	
HLRS 4012-01-040			1.2	RO.1	4	4.13	4.27	4.41	4.56
HLRS 4012-01-060		6			6.20	6.40	6.61	6.84	7.34
HLRS 4012-01-100		10			10.32	10.66	11.01	11.39	12.24
HLRS 4012-02-040		RO.2		4	4.13	4.26	4.40	4.55	4.87
HLRS 4012-02-060				6	6.19	6.39	6.60	6.82	7.32
HLRS 4012-02-100				10	10.32	10.65	11.00	11.38	12.22
HLRS 4012-03-040	RO.3	4		4.13	4.25	4.39	4.53	4.85	
HLRS 4012-03-060		6		6.19	6.38	6.59	6.81	7.30	
HLRS 4012-03-100		10		10.32	10.64	10.99	11.36	12.20	

4 Flutes

UDC Series

CBN Series

Square

Square

Long Neck Square

Radius

Radius

Long Neck Radius

Taper Neck Radius

Ball / Long Shank Ball

Ball

Long Neck Ball

Taper Neck Ball

Taper

Spiral V Cutter

Drill

EURO Series

Technical Data

Model Number	Outside Diameter ϕD	Corner Radius CR	Effective Length ℓ_1	Length of Cut ℓ	Neck Diameter ϕd_1	Shank Taper Angle Bta	Overall Length L	Shank Diameter ϕd	Price ¥	
HLRS 4015-005-030	1.5	RO.05	3	1.2	1.45	16°	50	4	7,900	
HLRS 4015-005-040			4				50	4	7,900	
HLRS 4015-005-060			6				50	4	7,900	
HLRS 4015-005-080			8				50	4	8,200	
HLRS 4015-005-120			12				55	4	8,200	
HLRS 4015-005-160			16				60	4	8,200	
HLRS 4015-01-030		RO.1	3				50	4	7,900	
HLRS 4015-01-040			4				50	4	7,900	
HLRS 4015-01-060			6				50	4	7,900	
HLRS 4015-01-080			8				50	4	8,200	
HLRS 4015-01-100			10				50	4	8,200	
HLRS 4015-01-120			12				55	4	8,200	
HLRS 4015-01-160			16				60	4	8,200	
※ HLRS 4015-01-180			18				60	4	8,200	
HLRS 4015-02-030			RO.2				3	50	4	7,900
HLRS 4015-02-040							4	50	4	7,900
HLRS 4015-02-060							6	50	4	7,900
HLRS 4015-02-080							8	50	4	8,200
HLRS 4015-02-100		10					50	4	8,200	
HLRS 4015-02-120		12					55	4	8,200	
HLRS 4015-02-160		16	60				4	8,200		
※ HLRS 4015-02-180		18	60				4	8,200		
HLRS 4015-03-030		RO.3	3				50	4	7,900	
HLRS 4015-03-040			4				50	4	7,900	
HLRS 4015-03-060			6				50	4	7,900	
HLRS 4015-03-080			8				50	4	8,200	
HLRS 4015-03-100			10				50	4	8,200	
HLRS 4015-03-120			12				55	4	8,200	
HLRS 4015-03-160		16	60				4	8,200		
※ HLRS 4015-03-180		18	60				4	8,200		
HLRS 4015-05-030	RO.5	3	50	4	7,900					
HLRS 4015-05-040		4	50	4	7,900					
HLRS 4015-05-060		6	50	4	7,900					
HLRS 4015-05-080		8	50	4	8,200					
HLRS 4015-05-100		10	50	4	8,200					
HLRS 4015-05-120		12	55	4	8,200					
HLRS 4015-05-160	16	60	4	8,200						
※ HLRS 4015-05-180	18	60	4	8,200						

UDC Series

CBN Series

Square
Long Neck Square

Radius

Radius
Long Neck Radius
Taper Neck Radius

Ball / Long Shank Ball
Long Neck Ball

Taper Neck Ball

Taper

Spiral V Cutter

Drill

EURO Series

Technical Data

Model Number	Outside Diameter ϕD	Corner Radius CR	Effective Length l_1	Effective Length by Inclined Angles				
				30'	1°	1°30'	2°	3°
HLRS 4015-005-030	1.5	RO.05	3	3.10	3.20	3.31	3.43	3.68
HLRS 4015-005-040			4	4.14	4.27	4.41	4.57	4.91
HLRS 4015-005-060			6	6.20	6.40	6.61	6.84	7.35
HLRS 4015-005-080			8	8.26	8.53	8.82	9.12	9.80
HLRS 4015-005-120			12	12.39	12.79	13.22	13.68	14.70
HLRS 4015-005-160			16	16.51	17.05	17.62	18.23	19.59
HLRS 4015-01-030		RO.1	3	3.10	3.20	3.31	3.42	3.67
HLRS 4015-01-040			4	4.13	4.27	4.41	4.56	4.90
HLRS 4015-01-060			6	6.20	6.40	6.61	6.84	7.34
HLRS 4015-01-080			8	8.26	8.53	8.81	9.11	9.79
HLRS 4015-01-100			10	10.32	10.66	11.01	11.39	12.24
HLRS 4015-01-120			12	12.39	12.79	13.21	13.67	14.69
HLRS 4015-01-160			16	16.51	17.04	17.61	18.22	19.58
HLRS 4015-01-180			18	18.57	19.17	19.82	20.50	22.03
HLRS 4015-02-030		RO.2	3	3.10	3.20	3.30	3.41	3.65
HLRS 4015-02-040			4	4.13	4.26	4.40	4.55	4.87
HLRS 4015-02-060			6	6.19	6.39	6.60	6.82	7.32
HLRS 4015-02-080			8	8.26	8.52	8.80	9.10	9.77
HLRS 4015-02-100			10	10.32	10.65	11.00	11.38	12.22
HLRS 4015-02-120			12	12.38	12.78	13.20	13.66	14.66
HLRS 4015-02-160			16	16.51	17.04	17.60	18.21	19.56
HLRS 4015-02-180			18	18.57	19.17	19.81	20.49	22.01
HLRS 4015-03-030		RO.3	3	3.10	3.19	3.29	3.39	3.63
HLRS 4015-03-040			4	4.13	4.25	4.39	4.53	4.85
HLRS 4015-03-060			6	6.19	6.38	6.59	6.81	7.30
HLRS 4015-03-080			8	8.25	8.51	8.79	9.09	9.75
HLRS 4015-03-100			10	10.32	10.64	10.99	11.36	12.20
HLRS 4015-03-120			12	12.38	12.77	13.19	13.64	14.64
HLRS 4015-03-160			16	16.50	17.03	17.59	18.20	19.54
HLRS 4015-03-180			18	18.57	19.16	19.80	20.47	21.98
HLRS 4015-05-030		RO.5	3	3.09	3.17	3.27	3.36	3.58
HLRS 4015-05-040			4	4.12	4.24	4.37	4.50	4.81
HLRS 4015-05-060			6	6.18	6.37	6.57	6.78	7.25
HLRS 4015-05-080			8	8.25	8.50	8.77	9.06	9.70
HLRS 4015-05-100			10	10.31	10.63	10.97	11.34	12.15
HLRS 4015-05-120			12	12.37	12.76	13.17	13.61	14.60
HLRS 4015-05-160			16	16.50	17.02	17.57	18.17	19.49
HLRS 4015-05-180			18	18.56	19.15	19.77	20.44	21.94

4 Flutes

UDC Series

CBN Series

Square

Long Neck Square

Radius

Long Neck Radius

Taper Neck Radius

Ball / Long Shank Ball

Long Neck Ball

Taper Neck Ball

Taper

Spiral V Cutter

Drill

EURO Series

Technical Data

Model Number	Outside Diameter ϕD	Corner Radius CR	Effective Length ℓ_1	Length of Cut ℓ	Neck Diameter ϕd_1	Shank Taper Angle Bta	Overall Length L	Shank Diameter ϕd	Price ¥	
HLRS 4018-02-080	1.8	RO.2	8	1.44	1.72	16°	50	4	8,200	
HLRS 4018-02-100			10				50	4	8,200	
HLRS 4018-02-120			12				55	4	8,200	
HLRS 4018-02-140			14				55	4	8,200	
HLRS 4018-02-160			16				60	4	8,200	
HLRS 4020-002-040	2	RO.02	4	1.6	1.92	16°	50	4	7,900	
HLRS 4020-002-060			6				50	4	7,900	
HLRS 4020-002-080			8				50	4	8,200	
HLRS 4020-002-100			10				50	4	8,200	
HLRS 4020-002-120			12				55	4	8,200	
HLRS 4020-002-160			16				60	4	8,200	
HLRS 4020-002-200			20				60	4	8,200	
HLRS 4020-005-040			RO.05				4	50	4	7,900
HLRS 4020-005-060							6	50	4	7,900
HLRS 4020-005-080							8	50	4	8,200
HLRS 4020-005-100		10					50	4	8,200	
HLRS 4020-005-120		12					55	4	8,200	
HLRS 4020-005-160		16					60	4	8,200	
HLRS 4020-005-200		20					60	4	8,200	
HLRS 4020-01-040		RO.1					4	50	4	7,900
HLRS 4020-01-060							6	50	4	7,900
HLRS 4020-01-080							8	50	4	8,200
HLRS 4020-01-100			10				50	4	8,200	
HLRS 4020-01-120			12				55	4	8,200	
HLRS 4020-01-160			16				60	4	8,200	
HLRS 4020-01-200			20				60	4	8,200	
※ HLRS 4020-01-240			24				70	4	8,200	
HLRS 4020-02-040			RO.2				4	50	4	7,900
HLRS 4020-02-060							6	50	4	7,900
HLRS 4020-02-080		8					50	4	8,200	
HLRS 4020-02-100		10					50	4	8,200	
HLRS 4020-02-120		12					55	4	8,200	
HLRS 4020-02-160		16					60	4	8,200	
HLRS 4020-02-200		20					60	4	8,200	
※ HLRS 4020-02-240		24					70	4	8,200	
HLRS 4020-03-040	RO.3	4		50	4	7,900				
HLRS 4020-03-060		6		50	4	7,900				
HLRS 4020-03-080		8	50	4	8,200					
HLRS 4020-03-100		10	50	4	8,200					
HLRS 4020-03-120		12	55	4	8,200					
HLRS 4020-03-160		16	60	4	8,200					
HLRS 4020-03-200		20	60	4	8,200					
※ HLRS 4020-03-240		24	70	4	8,200					

UDC Series

CBN Series

Square
Long Neck Square

Radius
Long Neck Radius

Taper Neck Radius

Ball / Long Shank Ball
Long Neck Ball

※ Taper Neck Ball

Taper

Spiral V Cutter

※ Drill

EURO Series

Technical Data

Model Number	Outside Diameter ϕD	Corner Radius CR	Effective Length l_1	Effective Length by Inclined Angles				
				30'	1°	1°30'	2°	3°
HLRS 4018-02-080	1.8	RO.2	8	8.29	8.56	8.84	9.14	9.81
HLRS 4018-02-100			10	10.36	10.69	11.04	11.42	12.26
HLRS 4018-02-120			12	12.42	12.82	13.24	13.69	14.71
HLRS 4018-02-140			14	14.48	14.95	15.44	15.97	17.15
HLRS 4018-02-160			16	16.54	17.08	17.64	18.25	19.60
HLRS 4020-002-040			2	RO.02	4	4.17	4.31	4.45
HLRS 4020-002-060	6	6.24			6.44	6.66	6.89	7.40
HLRS 4020-002-080	8	8.30			8.57	8.86	9.16	9.85
HLRS 4020-002-100	10	10.36			10.70	11.06	11.44	12.30
HLRS 4020-002-120	12	12.42			12.83	13.26	13.72	14.75
HLRS 4020-002-160	16	16.55			17.09	17.66	18.27	No Interference
HLRS 4020-002-200	20	20.67		21.35	22.06	22.83	No Interference	
HLRS 4020-005-040	RO.05	4		4.17	4.31	4.45	4.61	4.95
HLRS 4020-005-060		6		6.23	6.44	6.65	6.88	7.40
HLRS 4020-005-080		8		8.30	8.57	8.85	9.16	9.84
HLRS 4020-005-100		10		10.36	10.70	11.05	11.44	12.29
HLRS 4020-005-120		12		12.42	12.83	13.26	13.72	14.74
HLRS 4020-005-160		16		16.55	17.08	17.66	18.27	No Interference
HLRS 4020-005-200	20	20.67		21.34	22.06	22.82	No Interference	
HLRS 4020-01-040	RO.1	4		4.17	4.30	4.45	4.60	4.94
HLRS 4020-01-060		6		6.23	6.43	6.65	6.88	7.39
HLRS 4020-01-080		8		8.30	8.56	8.85	9.15	9.83
HLRS 4020-01-100		10		10.36	10.69	11.05	11.43	12.28
HLRS 4020-01-120		12		12.42	12.82	13.25	13.71	14.73
HLRS 4020-01-160		16		16.55	17.08	17.65	18.26	No Interference
HLRS 4020-01-200		20	20.67	21.34	22.05	22.82	No Interference	
HLRS 4020-01-240		24	24.80	25.60	26.46	27.37	No Interference	
HLRS 4020-02-040	RO.2	4	4.17	4.30	4.44	4.59	4.92	
HLRS 4020-02-060		6	6.23	6.43	6.64	6.86	7.36	
HLRS 4020-02-080		8	8.29	8.56	8.84	9.14	9.81	
HLRS 4020-02-100		10	10.36	10.69	11.04	11.42	12.26	
HLRS 4020-02-120		12	12.42	12.82	13.24	13.69	14.71	
HLRS 4020-02-160		16	16.54	17.08	17.64	18.25	19.60	
HLRS 4020-02-200		20	20.67	21.33	22.04	22.80	No Interference	
HLRS 4020-02-240		24	24.79	25.59	26.45	27.36	No Interference	
HLRS 4020-03-040	RO.3	4	4.16	4.29	4.43	4.57	4.90	
HLRS 4020-03-060		6	6.23	6.42	6.63	6.85	7.34	
HLRS 4020-03-080		8	8.29	8.55	8.83	9.13	9.79	
HLRS 4020-03-100		10	10.35	10.68	11.03	11.40	12.24	
HLRS 4020-03-120		12	12.41	12.81	13.23	13.68	14.68	
HLRS 4020-03-160		16	16.54	17.07	17.63	18.24	19.58	
HLRS 4020-03-200		20	20.67	21.33	22.03	22.79	No Interference	
HLRS 4020-03-240		24	24.79	25.59	26.44	27.35	No Interference	

4 Flutes

UDC Series

CBN Series

Square

Square

Long Neck Square

Radius

Long Neck Radius

Taper Neck Radius

Ball / Long Shank Ball

Long Neck Ball

Taper Neck Ball

Ball

Taper

Spiral V Cutter

Drill

Taper

Spiral V Cutter

Drill

EURO Series

Technical Data

Model Number	Outside Diameter ϕD	Corner Radius CR	Effective Length ℓ_1	Length of Cut ℓ	Neck Diameter ϕd_1	Shank Taper Angle Bta	Overall Length L	Shank Diameter ϕd	Price ¥
HLRS 4020-05-040	2	RO.5	4	1.6	1.92	16°	50	4	7,900
HLRS 4020-05-060			6				50	4	7,900
HLRS 4020-05-080			8				50	4	8,200
HLRS 4020-05-100			10				50	4	8,200
HLRS 4020-05-120			12				55	4	8,200
HLRS 4020-05-160			16				60	4	8,200
HLRS 4020-05-200			20				60	4	8,200
※ HLRS 4020-05-240			24				70	4	8,200
※ HLRS 4020-05-260			26				70	4	8,200
※ HLRS 4020-05-300	30	70	4	8,200					
HLRS 4025-01-060	2.5	RO.1	6	2	2.42	16°	50	4	8,600
HLRS 4025-01-080			8				50	4	8,600
HLRS 4025-01-100			10				50	4	8,600
HLRS 4025-01-160			16				60	4	8,900
HLRS 4025-01-200			20				60	4	8,900
HLRS 4025-01-300			30				70	4	9,200
HLRS 4025-02-060		RO.2	6				50	4	8,600
HLRS 4025-02-080			8				50	4	8,600
HLRS 4025-02-100			10				50	4	8,600
HLRS 4025-02-160			16				60	4	8,900
HLRS 4025-02-200			20				60	4	8,900
HLRS 4025-02-300			30				70	4	9,200
HLRS 4025-03-060		RO.3	6				50	4	8,600
HLRS 4025-03-080			8				50	4	8,600
HLRS 4025-03-100			10				50	4	8,600
HLRS 4025-03-160			16				60	4	8,900
HLRS 4025-03-200			20				60	4	8,900
HLRS 4025-03-300			30				70	4	9,200
HLRS 4025-05-060	RO.5	6	50	4	8,600				
HLRS 4025-05-080		8	50	4	8,600				
HLRS 4025-05-100		10	50	4	8,600				
HLRS 4025-05-160		16	60	4	8,900				
HLRS 4025-05-200		20	60	4	8,900				
HLRS 4025-05-300		30	70	4	9,200				

UDC Series

CBN Series

Square

Long Neck Square

Radius

Long Neck Radius
Taper Neck Radius

Ball / Long Shank Ball

Long Neck Ball
Taper Neck Ball

Taper

Spiral V Cutter

Drill

EURO Series

Technical Data

Model Number	Outside Diameter ϕD	Corner Radius CR	Effective Length l_1	Effective Length by Inclined Angles				
				30'	1°	1°30'	2°	3°
HLRS 4020-05-040	2	RO.5	4	4.16	4.28	4.40	4.54	4.85
HLRS 4020-05-060			6	6.22	6.41	6.61	6.82	7.30
HLRS 4020-05-080			8	8.28	8.54	8.81	9.10	9.74
HLRS 4020-05-100			10	10.34	10.67	11.01	11.37	12.19
HLRS 4020-05-120			12	12.41	12.79	13.21	13.65	14.64
HLRS 4020-05-160			16	16.53	17.05	17.61	18.21	19.53
HLRS 4020-05-200			20	20.66	21.31	22.01	22.76	No Interference
HLRS 4020-05-240			24	24.78	25.57	26.41	27.32	No Interference
HLRS 4020-05-260			26	26.85	27.70	28.62	29.59	No Interference
HLRS 4020-05-300			30	30.97	31.96	33.02	No Interference	No Interference
HLRS 4025-01-060			2.5	RO.1	6	6.23	6.43	6.65
HLRS 4025-01-080	8	8.30			8.56	8.85	9.15	9.83
HLRS 4025-01-100	10	10.36			10.69	11.05	11.43	12.28
HLRS 4025-01-160	16	16.55			17.08	17.65	18.26	No Interference
HLRS 4025-01-200	20	20.67			21.34	22.05	No Interference	No Interference
HLRS 4025-01-300	30	30.99			31.99	No Interference	No Interference	No Interference
HLRS 4025-02-060	RO.2	6		6.23	6.43	6.64	6.86	7.36
HLRS 4025-02-080		8		8.29	8.56	8.84	9.14	9.81
HLRS 4025-02-100		10		10.36	10.69	11.04	11.42	12.26
HLRS 4025-02-160		16		16.54	17.08	17.64	18.25	No Interference
HLRS 4025-02-200		20		20.67	21.33	22.04	No Interference	No Interference
HLRS 4025-02-300		30		30.98	31.98	No Interference	No Interference	No Interference
HLRS 4025-03-060	RO.3	6		6.23	6.42	6.63	6.85	7.34
HLRS 4025-03-080		8		8.29	8.55	8.83	9.13	9.79
HLRS 4025-03-100		10		10.35	10.68	11.03	11.40	12.24
HLRS 4025-03-160		16		16.54	17.07	17.63	18.24	No Interference
HLRS 4025-03-200		20		20.67	21.33	22.03	No Interference	No Interference
HLRS 4025-03-300		30		30.98	31.98	No Interference	No Interference	No Interference
HLRS 4025-05-060	RO.5	6		6.22	6.41	6.61	6.82	7.30
HLRS 4025-05-080		8		8.28	8.54	8.81	9.10	9.74
HLRS 4025-05-100		10		10.34	10.67	11.01	11.37	12.19
HLRS 4025-05-160		16		16.53	17.05	17.61	18.21	No Interference
HLRS 4025-05-200		20		20.66	21.31	22.01	No Interference	No Interference
HLRS 4025-05-300		30		30.97	31.96	No Interference	No Interference	No Interference

4 Flutes

UDC Series

CBN Series

Square

Square

Long Neck Square

Radius

Long Neck Radius

Taper Neck Radius

Ball / Long Shank Ball

Long Neck Ball

Taper Neck Ball

Ball

Taper

Spiral V Cutter

Drill

Taper

Spiral V Cutter

Drill

EURO Series

Technical Data

Model Number	Outside Diameter ϕD	Corner Radius CR	Effective Length ℓ_1	Length of Cut ℓ	Neck Diameter ϕd_1	Shank Taper Angle β	Overall Length L	Shank Diameter ϕd	Price ¥	
HLRS 4030-005-040	3	RO.05	4	2.4	2.92	16°	55	6	7,100	
HLRS 4030-005-060			6				55	6	7,100	
HLRS 4030-005-080			8				55	6	7,100	
HLRS 4030-005-100			10				55	6	7,100	
HLRS 4030-005-120			12				55	6	8,600	
HLRS 4030-005-160			16				60	6	10,600	
HLRS 4030-005-200			20				60	6	10,600	
HLRS 4030-01-040		RO.1	4				55	6	7,100	
HLRS 4030-01-060			6				55	6	7,100	
HLRS 4030-01-080			8				55	6	7,100	
HLRS 4030-01-100			10				55	6	7,100	
HLRS 4030-01-120			12				55	6	8,600	
HLRS 4030-01-160			16				60	6	10,600	
HLRS 4030-01-180			18				60	6	10,600	
HLRS 4030-01-200			20				60	6	10,600	
HLRS 4030-01-240			24				70	6	10,600	
HLRS 4030-01-260			26				70	6	10,600	
HLRS 4030-01-300			30				70	6	12,000	
HLRS 4030-02-040			RO.2				4	55	6	7,100
HLRS 4030-02-060							6	55	6	7,100
HLRS 4030-02-080							8	55	6	7,100
HLRS 4030-02-100							10	55	6	7,100
HLRS 4030-02-120							12	55	6	8,600
HLRS 4030-02-160							16	60	6	10,600
HLRS 4030-02-180							18	60	6	10,600
HLRS 4030-02-200		20					60	6	10,600	
HLRS 4030-02-240		24					70	6	10,600	
HLRS 4030-02-260		26					70	6	10,600	
HLRS 4030-02-300		30					70	6	12,000	
※ HLRS 4030-02-360		36					80	6	12,000	
HLRS 4030-03-040		RO.3	4				55	6	7,100	
HLRS 4030-03-060			6				55	6	7,100	
HLRS 4030-03-080			8				55	6	7,100	
HLRS 4030-03-100			10				55	6	7,100	
HLRS 4030-03-120			12				55	6	8,600	
HLRS 4030-03-140			14				55	6	8,600	
HLRS 4030-03-160	16		60	6	10,600					
HLRS 4030-03-200	20		60	6	10,600					
HLRS 4030-03-240	24		70	6	10,600					
HLRS 4030-03-260	26		70	6	10,600					
HLRS 4030-03-300	30		70	6	12,000					
※ HLRS 4030-03-360	36		80	6	12,000					

UDC Series

CBN Series

Square
Long Neck Square

Radius
Long Neck Radius

Taper Neck Radius

Ball / Long Shank Ball
Long Neck Ball
Taper Neck Ball

Taper

Spiral V Cutter

Drill

EURO Series

Technical Data

Model Number	Outside Diameter ϕD	Corner Radius CR	Effective Length l_1	Effective Length by Inclined Angles				
				30'	1°	1°30'	2°	3°
HLRS 4030-005-040	3	RO.05	4	4.17	4.31	4.45	4.60	4.95
HLRS 4030-005-060			6	6.23	6.43	6.65	6.88	7.40
HLRS 4030-005-080			8	8.30	8.56	8.85	9.16	9.84
HLRS 4030-005-100			10	10.36	10.69	11.05	11.44	12.29
HLRS 4030-005-120			12	12.42	12.82	13.25	13.71	14.74
HLRS 4030-005-160			16	16.55	17.08	17.66	18.27	19.63
HLRS 4030-005-200			20	20.67	21.34	22.06	22.82	24.53
HLRS 4030-01-040			RO.1	4	4.17	4.30	4.44	4.60
HLRS 4030-01-060		6		6.23	6.43	6.65	6.87	7.38
HLRS 4030-01-080		8		8.29	8.56	8.85	9.15	9.83
HLRS 4030-01-100		10		10.36	10.69	11.05	11.43	12.28
HLRS 4030-01-120		12		12.42	12.82	13.25	13.71	14.73
HLRS 4030-01-160		16		16.54	17.08	17.65	18.26	19.62
HLRS 4030-01-180		18		18.61	19.21	19.85	20.54	22.07
HLRS 4030-01-200		20		20.67	21.34	22.05	22.82	24.52
HLRS 4030-01-240		24		24.80	25.60	26.45	27.37	No Interference
HLRS 4030-01-260		26		26.86	27.73	28.66	29.65	No Interference
HLRS 4030-01-300		30	30.98	31.99	33.06	34.20	No Interference	
HLRS 4030-02-040		RO.2	4	4.17	4.30	4.43	4.58	4.92
HLRS 4030-02-060			6	6.23	6.43	6.64	6.86	7.36
HLRS 4030-02-080			8	8.29	8.55	8.84	9.14	9.81
HLRS 4030-02-100			10	10.35	10.68	11.04	11.42	12.26
HLRS 4030-02-120			12	12.42	12.81	13.24	13.69	14.70
HLRS 4030-02-160			16	16.54	17.07	17.64	18.25	19.60
HLRS 4030-02-180			18	18.60	19.20	19.84	20.53	22.05
HLRS 4030-02-200			20	20.67	21.33	22.04	22.80	24.49
HLRS 4030-02-240			24	24.79	25.59	26.44	27.36	No Interference
HLRS 4030-02-260			26	26.86	27.72	28.65	29.63	No Interference
HLRS 4030-02-300		30	30.98	31.98	33.05	34.19	No Interference	
HLRS 4030-02-360		36	37.17	38.37	39.65	41.02	No Interference	
HLRS 4030-03-040		RO.3	4	4.16	4.29	4.42	4.57	4.89
HLRS 4030-03-060			6	6.22	6.42	6.63	6.85	7.34
HLRS 4030-03-080			8	8.29	8.55	8.83	9.12	9.79
HLRS 4030-03-100			10	10.35	10.68	11.03	11.40	12.24
HLRS 4030-03-120			12	12.41	12.81	13.23	13.68	14.68
HLRS 4030-03-140			14	14.48	14.94	15.43	15.96	17.13
HLRS 4030-03-160	16		16.54	17.07	17.63	18.23	19.58	
HLRS 4030-03-200	20		20.66	21.33	22.03	22.79	24.47	
HLRS 4030-03-240	24		24.79	25.59	26.43	27.34	No Interference	
HLRS 4030-03-260	26		26.85	27.71	28.64	29.62	No Interference	
HLRS 4030-03-300	30	30.98	31.97	33.04	34.18	No Interference		
HLRS 4030-03-360	36	37.17	38.36	39.64	41.01	No Interference		

4 Flutes

UDC Series

CBN Series

Square

Square

Long Neck Square

Radius

Radius

Long Neck Radius

Taper Neck Radius

Ball / Long Shank Ball

Ball

Long Neck Ball

Taper Neck Ball

Taper

Taper

Spiral V Cutter

Drill

EURO Series

Technical Data

Model Number	Outside Diameter ϕD	Corner Radius CR	Effective Length ℓ_1	Length of Cut ℓ	Neck Diameter ϕd_1	Shank Taper Angle Bta	Overall Length L	Shank Diameter ϕd	Price ¥
HLRS 4030-05-040	3	R0.5	4	2.4	2.92	16°	55	6	7,100
HLRS 4030-05-060			6				55	6	7,100
HLRS 4030-05-080			8				55	6	7,100
HLRS 4030-05-100			10				55	6	7,100
HLRS 4030-05-120			12				55	6	8,600
HLRS 4030-05-160			16				60	6	10,600
HLRS 4030-05-200			20				60	6	10,600
HLRS 4030-05-240			24				70	6	10,600
HLRS 4030-05-260			26				70	6	10,600
HLRS 4030-05-300			30				70	6	12,000
※ HLRS 4030-05-360		36	80				6	12,000	
HLRS 4030-10-060		R1	6				55	6	7,100
HLRS 4030-10-080			8				55	6	7,100
HLRS 4030-10-100			10				55	6	7,100
HLRS 4030-10-120			12				55	6	8,600
HLRS 4030-10-160			16				60	6	10,600
HLRS 4030-10-200			20				60	6	10,600
HLRS 4030-10-240			24				70	6	10,600
HLRS 4030-10-260			26				70	6	10,600
HLRS 4030-10-300			30				70	6	12,000
※ HLRS 4030-10-360	36		80	6	12,000				
HLRS 4040-005-080	4	R0.05	8	3.2	3.82	16°	65	6	10,600
HLRS 4040-005-120			12				65	6	10,600
HLRS 4040-005-160			16				65	6	10,600
HLRS 4040-005-200			20				70	6	11,800
HLRS 4040-005-240			24				70	6	11,800
HLRS 4040-005-320			32				80	6	11,800
HLRS 4040-01-080		R0.1	8				65	6	10,600
HLRS 4040-01-120			12				65	6	10,600
HLRS 4040-01-160			16				65	6	10,600
HLRS 4040-01-200			20				70	6	11,800
HLRS 4040-01-240			24				70	6	11,800
HLRS 4040-01-320			32				80	6	11,800
※ HLRS 4040-01-480		48	100				6	18,800	
HLRS 4040-02-080		R0.2	8				65	6	10,600
HLRS 4040-02-120			12				65	6	10,600
HLRS 4040-02-160			16				65	6	10,600
HLRS 4040-02-200			20				70	6	11,800
HLRS 4040-02-240			24				70	6	11,800
HLRS 4040-02-320			32				80	6	11,800
※ HLRS 4040-02-480			48				100	6	18,800

UDC Series

CBN Series

Square
Long Neck Square

Radius
Long Neck Radius
Taper Neck Radius

Ball / Long Shank Ball
Long Neck Ball
Taper Neck Ball

Taper

Spiral V Cutter

Drill

EURO Series

Technical Data

Model Number	Outside Diameter ϕD	Corner Radius CR	Effective Length l_1	Effective Length by Inclined Angles						
				30'	1°	1°30'	2°	3°		
HLRS 4030-05-040	3	RO.5	4	4.15	4.27	4.40	4.54	4.85		
HLRS 4030-05-060			6	6.22	6.40	6.60	6.82	7.30		
HLRS 4030-05-080			8	8.28	8.53	8.80	9.10	9.74		
HLRS 4030-05-100			10	10.34	10.66	11.01	11.37	12.19		
HLRS 4030-05-120			12	12.40	12.79	13.21	13.65	14.64		
HLRS 4030-05-160			16	16.53	17.05	17.61	18.20	19.53		
HLRS 4030-05-200			20	20.66	21.31	22.01	22.76	24.43		
HLRS 4030-05-240			24	24.78	25.57	26.41	27.31	29.32		
HLRS 4030-05-260			26	26.84	27.70	28.61	29.59	No Interference		
HLRS 4030-05-300			30	30.97	31.96	33.02	34.15	No Interference		
HLRS 4030-05-360			36	37.16	38.35	39.62	40.98	No Interference		
HLRS 4030-10-060			R1	6	6.20	6.37	6.55	6.75	7.18	
HLRS 4030-10-080		8		8.26	8.50	8.75	9.03	9.63		
HLRS 4030-10-100		10		10.32	10.63	10.95	11.30	12.08		
HLRS 4030-10-120		12		12.39	12.76	13.16	13.58	14.53		
HLRS 4030-10-160		16		16.51	17.02	17.56	18.13	19.42		
HLRS 4030-10-200		20		20.64	21.28	21.96	22.69	24.32		
HLRS 4030-10-240		24		24.76	25.54	26.36	27.24	29.21		
HLRS 4030-10-260		26		26.83	27.67	28.56	29.52	No Interference		
HLRS 4030-10-300		30		30.95	31.93	32.96	34.08	No Interference		
HLRS 4030-10-360		36		37.14	38.31	39.57	40.91	No Interference		
HLRS 4040-005-080		4		RO.05	8	8.48	8.75	9.04	9.36	10.06
HLRS 4040-005-120					12	12.60	13.01	13.45	13.91	14.95
HLRS 4040-005-160			16		16.73	17.27	17.85	18.47	No Interference	
HLRS 4040-005-200			20		20.85	21.53	22.25	23.02	No Interference	
HLRS 4040-005-240			24		24.98	25.79	26.65	27.58	No Interference	
HLRS 4040-005-320			32		33.23	34.31	35.46	No Interference	No Interference	
HLRS 4040-01-080			RO.1	8	8.47	8.75	9.04	9.35	10.05	
HLRS 4040-01-120				12	12.60	13.01	13.44	13.91	14.94	
HLRS 4040-01-160				16	16.72	17.27	17.84	18.46	No Interference	
HLRS 4040-01-200				20	20.85	21.52	22.24	23.01	No Interference	
HLRS 4040-01-240				24	24.98	25.78	26.65	27.57	No Interference	
HLRS 4040-01-320				32	33.23	34.30	35.45	No Interference	No Interference	
HLRS 4040-01-480				48	49.73	51.34	No Interference	No Interference	No Interference	
HLRS 4040-02-080				RO.2	8	8.47	8.74	9.03	9.34	10.02
HLRS 4040-02-120			12		12.60	13.00	13.43	13.89	14.92	
HLRS 4040-02-160	16		16.72		17.26	17.83	18.45	No Interference		
HLRS 4040-02-200	20		20.85		21.52	22.23	23.00	No Interference		
HLRS 4040-02-240	24		24.97		25.78	26.64	27.56	No Interference		
HLRS 4040-02-320	32		33.22		34.30	35.44	No Interference	No Interference		
HLRS 4040-02-480	48		49.73		51.33	No Interference	No Interference	No Interference		

4 Flutes

UDC Series

CBN Series

Square

Long Neck Square

Radius

Long Neck Radius

Taper Neck Radius

Ball / Long Shank Ball

Long Neck Ball

Taper Neck Ball

Taper

Spiral V Cutter

Drill

EURO Series

Technical Data

Unit (mm)

Model Number	Outside Diameter ϕD	Corner Radius CR	Effective Length ℓ_1	Length of Cut ℓ	Neck Diameter ϕd_1	Shank Taper Angle Bta	Overall Length L	Shank Diameter ϕd	Price ¥	
HLRS 4040-03-080	4	RO.3	8	3.2	3.82	16°	65	6	10,600	
HLRS 4040-03-120			12				65	6	10,600	
HLRS 4040-03-140			14				65	6	10,600	
HLRS 4040-03-160			16				65	6	10,600	
HLRS 4040-03-200			20				70	6	11,800	
HLRS 4040-03-240			24				70	6	11,800	
HLRS 4040-03-320			32				80	6	11,800	
※ HLRS 4040-03-480			48				100	6	18,800	
HLRS 4040-05-080		RO.5	8				65	6	10,600	
HLRS 4040-05-120			12				65	6	10,600	
HLRS 4040-05-160			16				65	6	10,600	
HLRS 4040-05-200			20				70	6	11,800	
HLRS 4040-05-240			24				70	6	11,800	
HLRS 4040-05-320			32				80	6	11,800	
※ HLRS 4040-05-400			40				100	6	17,500	
※ HLRS 4040-05-480			48				100	6	18,800	
HLRS 4040-10-080			R1				8	65	6	10,600
HLRS 4040-10-120							12	65	6	10,600
HLRS 4040-10-160							16	65	6	10,600
HLRS 4040-10-200							20	70	6	11,800
HLRS 4040-10-240							24	70	6	11,800
HLRS 4040-10-320							32	80	6	11,800
※ HLRS 4040-10-480							48	100	6	18,800
※ HLRS 4050-005-160							RO.05	16	65	6
※ HLRS 4050-005-200	20	70	6	14,000						
※ HLRS 4050-005-400	40	100	6	17,500						
HLRS 4050-01-160	RO.1	16	65	6	14,300					
HLRS 4050-01-200		20	70	6	14,000					
HLRS 4050-01-400		40	100	6	17,500					
HLRS 4050-02-160	RO.2	16	65	6	14,000					
HLRS 4050-02-200		20	70	6	14,000					
HLRS 4050-02-400		40	100	6	17,500					
HLRS 4050-03-160	RO.3	16	65	6	14,000					
HLRS 4050-03-200		20	70	6	14,000					
HLRS 4050-03-400		40	100	6	17,500					
HLRS 4050-05-160	RO.5	16	65	6	14,000					
HLRS 4050-05-200		20	70	6	14,000					
HLRS 4050-05-400		40	100	6	17,500					
HLRS 4050-10-160	R1	16	65	6	14,000					
HLRS 4050-10-200		20	70	6	14,000					
HLRS 4050-10-400		40	100	6	17,500					

※Additional model

Next Page ➡

UDC Series

CBN Series

Square
Long Neck Square

Radius

Long Neck Radius
Taper Neck Radius

Ball / Long Shank Ball
Long Neck Ball

Taper Neck Ball

Taper

Spiral V Cutter

Drill

EURO Series

Technical Data

Model Number	Outside Diameter ϕD	Corner Radius CR	Effective Length l_1	Effective Length by Inclined Angles					
				30'	1°	1°30'	2°	3°	
HLRS 4040-03-080	4	RO.3	8	8.47	8.73	9.02	9.32	10.00	
HLRS 4040-03-120			12	12.59	12.99	13.42	13.88	14.90	
HLRS 4040-03-140			14	14.66	15.12	15.62	16.16	17.34	
HLRS 4040-03-160			16	16.72	17.25	17.82	18.43	No Interference	
HLRS 4040-03-200			20	20.84	21.51	22.22	22.99	No Interference	
HLRS 4040-03-240			24	24.97	25.77	26.63	27.54	No Interference	
HLRS 4040-03-320			32	33.22	34.29	35.43	No Interference	No Interference	
HLRS 4040-03-480			48	49.72	51.33	No Interference	No Interference	No Interference	
HLRS 4040-05-080		RO.5	8	8.46	8.72	9.00	9.29	9.96	
HLRS 4040-05-120			12	12.58	12.98	13.40	13.85	14.85	
HLRS 4040-05-160			16	16.71	17.24	17.80	18.40	19.75	
HLRS 4040-05-200			20	20.84	21.50	22.20	22.96	No Interference	
HLRS 4040-05-240			24	24.96	25.76	26.60	27.51	No Interference	
HLRS 4040-05-320			32	33.21	34.27	35.41	No Interference	No Interference	
HLRS 4040-05-400			40	41.46	42.79	No Interference	No Interference	No Interference	
HLRS 4040-05-480			48	49.71	51.31	No Interference	No Interference	No Interference	
HLRS 4040-10-080		R1	8	8.44	8.69	8.95	9.22	9.84	
HLRS 4040-10-120			12	12.57	12.94	13.35	13.78	14.74	
HLRS 4040-10-160			16	16.69	17.20	17.75	18.33	19.63	
HLRS 4040-10-200			20	20.82	21.46	22.15	22.89	No Interference	
HLRS 4040-10-240			24	24.94	25.72	26.55	27.44	No Interference	
HLRS 4040-10-320			32	33.20	34.24	35.36	No Interference	No Interference	
HLRS 4040-10-480			48	49.70	51.28	No Interference	No Interference	No Interference	
HLRS 4050-005-160			5	RO.05	16	16.73	17.27	17.85	No Interference
HLRS 4050-005-200		20			20.85	21.53	No Interference	No Interference	No Interference
HLRS 4050-005-400		40			41.48	No Interference	No Interference	No Interference	No Interference
HLRS 4050-01-160		RO.1		16	16.72	17.27	17.84	No Interference	No Interference
HLRS 4050-01-200				20	20.85	21.52	No Interference	No Interference	No Interference
HLRS 4050-01-400				40	41.48	No Interference	No Interference	No Interference	No Interference
HLRS 4050-02-160		RO.2		16	16.72	17.26	17.83	No Interference	No Interference
HLRS 4050-02-200				20	20.85	21.52	No Interference	No Interference	No Interference
HLRS 4050-02-400				40	41.47	No Interference	No Interference	No Interference	No Interference
HLRS 4050-03-160		RO.3		16	16.72	17.25	17.82	No Interference	No Interference
HLRS 4050-03-200				20	20.84	21.51	No Interference	No Interference	No Interference
HLRS 4050-03-400				40	41.47	No Interference	No Interference	No Interference	No Interference
HLRS 4050-05-160		RO.5		16	16.71	17.24	17.80	No Interference	No Interference
HLRS 4050-05-200				20	20.83	21.50	No Interference	No Interference	No Interference
HLRS 4050-05-400				40	41.46	No Interference	No Interference	No Interference	No Interference
HLRS 4050-10-160		R1		16	16.69	17.20	17.74	No Interference	No Interference
HLRS 4050-10-200				20	20.81	21.46	No Interference	No Interference	No Interference
HLRS 4050-10-400				40	41.44	No Interference	No Interference	No Interference	No Interference

4 Flutes

UDC Series

CBN Series

Square
Long Neck Square

Radius

Radius
Long Neck Radius
Taper Neck Radius

Ball / Long Shank Ball
Long Neck Ball

Taper Neck Ball
Taper

Spiral V Cutter

Drill

EURO Series

Technical Data

	Model Number	Outside Diameter ϕD	Corner Radius CR	Effective Length ℓ_1	Length of Cut ℓ	Neck Diameter ϕd_1	Shank Taper Angle Bta	Overall Length L	Shank Diameter ϕd	Price ¥																								
UDC Series	※ HLRS 4060-005-120	6	R0.05	12	4.8	5.82	—	65	6	15,400																								
	※ HLRS 4060-005-160			16				65	6	15,400																								
	※ HLRS 4060-005-200			20				70	6	15,400																								
	※ HLRS 4060-005-240			24				70	6	15,400																								
	※ HLRS 4060-005-300			30				100	6	18,000																								
	※ HLRS 4060-005-480			48				120	6	24,000																								
CBN Series	HLRS 4060-01-120		6	R0.1				12	4.8	5.82	—	65	6	15,400																				
	HLRS 4060-01-160							16				65	6	15,400																				
	HLRS 4060-01-180							18				70	6	15,400																				
	HLRS 4060-01-200							20				70	6	15,400																				
	HLRS 4060-01-240							24				70	6	15,400																				
	HLRS 4060-01-300							30				100	6	18,000																				
	HLRS 4060-01-480							48				120	6	24,000																				
	Square							HLRS 4060-02-120				6	R0.2	12	4.8	5.82	—	65	6	15,400														
HLRS 4060-02-160				16				65						6				15,400																
HLRS 4060-02-180				18				70						6				15,400																
HLRS 4060-02-200				20				70						6				15,400																
HLRS 4060-02-240				24				70						6				15,400																
HLRS 4060-02-300				30				100						6				18,000																
HLRS 4060-02-480				48				120						6				24,000																
Long Neck Square				HLRS 4060-03-120				6						R0.3				12	4.8	5.82	—	65	6	15,400										
	HLRS 4060-03-160			16									65					6				15,400												
	HLRS 4060-03-180			18									70					6				15,400												
	HLRS 4060-03-200			20									70					6				15,400												
	HLRS 4060-03-240			24									70					6				15,400												
	HLRS 4060-03-300			30									100					6				18,000												
	HLRS 4060-03-480			48									120					6				24,000												
	Radius			HLRS 4060-05-120									6					R0.5				12	4.8	5.82	—	65	6	15,400						
HLRS 4060-05-160				16										65								6				15,400								
HLRS 4060-05-180				18										70								6				15,400								
HLRS 4060-05-200				20										70								6				15,400								
HLRS 4060-05-240				24										70								6				15,400								
HLRS 4060-05-300				30										100								6				18,000								
HLRS 4060-05-400				40										100								6				18,000								
HLRS 4060-05-480				48										120								6				24,000								
Long Neck Radius	HLRS 4060-10-120			6										R1				12				4.8				5.82	—	65	6	15,400				
	HLRS 4060-10-160																	16										65	6	15,400				
	HLRS 4060-10-180																	18										70	6	15,400				
	HLRS 4060-10-200																	20										70	6	15,400				
	HLRS 4060-10-240																	24										70	6	15,400				
	HLRS 4060-10-300																	30										100	6	18,000				
	HLRS 4060-10-400																	40										100	6	18,000				
	HLRS 4060-10-480																	48										120	6	24,000				
Taper Neck Radius	HLRS 4060-03-120													6				R0.3										12	4.8	5.82	—	65	6	15,400
	HLRS 4060-03-160																											16				65	6	15,400
	HLRS 4060-03-180																											18				70	6	15,400
	HLRS 4060-03-200																											20				70	6	15,400
	HLRS 4060-03-240																											24				70	6	15,400
	HLRS 4060-03-300	30			100	6	18,000																											
	HLRS 4060-03-480	48			120	6	24,000																											
	Ball / Long Shank Ball	HLRS 4060-03-120			6	R0.3	12																					4.8				5.82	—	65
HLRS 4060-03-160		16					65											6																15,400
HLRS 4060-03-180		18					70											6																15,400
HLRS 4060-03-200		20					70											6																15,400
HLRS 4060-03-240		24	70				6		15,400																									
HLRS 4060-03-300		30	100				6		18,000																									
HLRS 4060-03-480		48	120				6		24,000																									
Long Neck Ball		HLRS 4060-03-120	6				R0.3		12	4.8	5.82							—																65
	HLRS 4060-03-160	16				65			6																									15,400
	HLRS 4060-03-180	18				70			6																									15,400
	HLRS 4060-03-200	20				70			6																									15,400
	HLRS 4060-03-240	24				70			6			15,400																						
	HLRS 4060-03-300	30				100			6			18,000																						
	HLRS 4060-03-480	48				120			6			24,000																						
	Taper Neck Ball	HLRS 4060-03-120				6			R0.3			12			4.8	5.82	—																	65
HLRS 4060-03-160		16					65					6																						15,400
HLRS 4060-03-180		18					70					6																						15,400
HLRS 4060-03-200		20					70					6																						15,400
HLRS 4060-03-240		24					70	6				15,400																						
HLRS 4060-03-300		30					100	6				18,000																						
HLRS 4060-03-480		48					120	6				24,000																						
Taper		HLRS 4060-05-120					6	R0.5				12							4.8	5.82	—													65
	HLRS 4060-05-160	16							65			6																						15,400
	HLRS 4060-05-180	18							70			6																						15,400
	HLRS 4060-05-200	20							70			6																						15,400
	HLRS 4060-05-240	24							70			6	15,400																					
	HLRS 4060-05-300	30							100			6	18,000																					
	HLRS 4060-05-400	40							100			6	18,000																					
	HLRS 4060-05-480	48							120			6	24,000																					
Spiral V Cutter	HLRS 4060-10-120	6						R1	12			4.8	5.82										—	65	6									15,400
	HLRS 4060-10-160								16															65	6									15,400
	HLRS 4060-10-180								18															70	6									15,400
	HLRS 4060-10-200								20															70	6									15,400
	HLRS 4060-10-240			24					70													6		15,400										
	HLRS 4060-10-300			30					100													6		18,000										
	HLRS 4060-10-400			40					100													6		18,000										
	HLRS 4060-10-480			48					120													6		24,000										
Drill	HLRS 4060-10-120			6				R1	12													4.8		5.82	—	65	6							15,400
	HLRS 4060-10-160								16																	65	6							15,400
	HLRS 4060-10-180								18																	70	6							15,400
	HLRS 4060-10-200								20																	70	6							15,400
	HLRS 4060-10-240								24					70												6	15,400							
	HLRS 4060-10-300								30					100												6	18,000							
	HLRS 4060-10-400								40					100												6	18,000							
	HLRS 4060-10-480								48					120												6	24,000							
EURO Series	HLRS 4060-10-120							6	R1					12												4.8	5.82		—	65	6			15,400
	HLRS 4060-10-160													16																65	6			15,400
	HLRS 4060-10-180													18																70	6			15,400
	HLRS 4060-10-200				20									70														6		15,400				
	HLRS 4060-10-240				24									70														6		15,400				
	HLRS 4060-10-300				30									100														6		18,000				
	HLRS 4060-10-400				40									100														6		18,000				
	HLRS 4060-10-480				48									120														6		24,000				
Technical Data	HLRS 4060-10-120				6				R1					12														4.8		5.82	—	65	6	15,400
	HLRS 4060-10-160													16																		65	6	15,400
	HLRS 4060-10-180		18							70	6			15,400																				
	HLRS 4060-10-200		20							70	6			15,400																				
	HLRS 4060-10-240		24							70	6			15,400																				
	HLRS 4060-10-300		30							100	6			18,000																				
	HLRS 4060-10-400		40							100	6			18,000																				
	HLRS 4060-10-480		48							120	6			24,000																				

※Additional model

Unit (mm)

Model Number	Outside Diameter ϕD	Corner Radius CR	Effective Length l_1	Effective Length by Inclined Angles				
				30'	1°	1°30'	2°	3°
HLRS 4060-005-120	6	RO.05	12	No Interference	No Interference	No Interference	No Interference	No Interference
HLRS 4060-005-160			16	No Interference	No Interference	No Interference	No Interference	No Interference
HLRS 4060-005-200			20	No Interference	No Interference	No Interference	No Interference	No Interference
HLRS 4060-005-240			24	No Interference	No Interference	No Interference	No Interference	No Interference
HLRS 4060-005-300			30	No Interference	No Interference	No Interference	No Interference	No Interference
HLRS 4060-005-480			48	No Interference	No Interference	No Interference	No Interference	No Interference
HLRS 4060-01-120		RO.1	12	No Interference	No Interference	No Interference	No Interference	No Interference
HLRS 4060-01-160			16	No Interference	No Interference	No Interference	No Interference	No Interference
HLRS 4060-01-180			18	No Interference	No Interference	No Interference	No Interference	No Interference
HLRS 4060-01-200			20	No Interference	No Interference	No Interference	No Interference	No Interference
HLRS 4060-01-240			24	No Interference	No Interference	No Interference	No Interference	No Interference
HLRS 4060-01-300			30	No Interference	No Interference	No Interference	No Interference	No Interference
HLRS 4060-01-480		48	No Interference	No Interference	No Interference	No Interference	No Interference	
HLRS 4060-02-120		RO.2	12	No Interference	No Interference	No Interference	No Interference	No Interference
HLRS 4060-02-160			16	No Interference	No Interference	No Interference	No Interference	No Interference
HLRS 4060-02-180			18	No Interference	No Interference	No Interference	No Interference	No Interference
HLRS 4060-02-200			20	No Interference	No Interference	No Interference	No Interference	No Interference
HLRS 4060-02-240			24	No Interference	No Interference	No Interference	No Interference	No Interference
HLRS 4060-02-300			30	No Interference	No Interference	No Interference	No Interference	No Interference
HLRS 4060-02-480		48	No Interference	No Interference	No Interference	No Interference	No Interference	
HLRS 4060-03-120		RO.3	12	No Interference	No Interference	No Interference	No Interference	No Interference
HLRS 4060-03-160			16	No Interference	No Interference	No Interference	No Interference	No Interference
HLRS 4060-03-180			18	No Interference	No Interference	No Interference	No Interference	No Interference
HLRS 4060-03-200			20	No Interference	No Interference	No Interference	No Interference	No Interference
HLRS 4060-03-240			24	No Interference	No Interference	No Interference	No Interference	No Interference
HLRS 4060-03-300			30	No Interference	No Interference	No Interference	No Interference	No Interference
HLRS 4060-03-480		48	No Interference	No Interference	No Interference	No Interference	No Interference	
HLRS 4060-05-120		RO.5	12	No Interference	No Interference	No Interference	No Interference	No Interference
HLRS 4060-05-160			16	No Interference	No Interference	No Interference	No Interference	No Interference
HLRS 4060-05-180			18	No Interference	No Interference	No Interference	No Interference	No Interference
HLRS 4060-05-200			20	No Interference	No Interference	No Interference	No Interference	No Interference
HLRS 4060-05-240			24	No Interference	No Interference	No Interference	No Interference	No Interference
HLRS 4060-05-300			30	No Interference	No Interference	No Interference	No Interference	No Interference
HLRS 4060-05-400			40	No Interference	No Interference	No Interference	No Interference	No Interference
HLRS 4060-05-480			48	No Interference	No Interference	No Interference	No Interference	No Interference
HLRS 4060-10-120		R1	12	No Interference	No Interference	No Interference	No Interference	No Interference
HLRS 4060-10-160			16	No Interference	No Interference	No Interference	No Interference	No Interference
HLRS 4060-10-180			18	No Interference	No Interference	No Interference	No Interference	No Interference
HLRS 4060-10-200			20	No Interference	No Interference	No Interference	No Interference	No Interference
HLRS 4060-10-240			24	No Interference	No Interference	No Interference	No Interference	No Interference
HLRS 4060-10-300			30	No Interference	No Interference	No Interference	No Interference	No Interference
HLRS 4060-10-400			40	No Interference	No Interference	No Interference	No Interference	No Interference
HLRS 4060-10-480			48	No Interference	No Interference	No Interference	No Interference	No Interference

4 Flutes

UDC Series

CBN Series

Square

Long Neck Square

Radius

Long Neck Radius

Taper Neck Radius

Ball / Long Shank Ball

Long Neck Ball

Taper Neck Ball

Taper

Spiral V Cutter

Drill

EURO Series

Technical Data

Milling Conditions for HLRS (4 Flutes)

WORK MATERIAL			PREHARDENED STEELS HARDENED STEELS NAK / SKD (30~45HRC)				HARDENED STEELS SKD / SKT (45~55HRC)				HARDENED STEELS SKD / SKH (55~65HRC)				
Model Number	Outside Diameter (mm)	Effective Length (mm)	Spindle Speed (min ⁻¹)	Feed Rate (mm/min)	a_p Axial Depth (mm)	a_e Radial Depth (mm)	Spindle Speed (min ⁻¹)	Feed Rate (mm/min)	a_p Axial Depth (mm)	a_e Radial Depth (mm)	Spindle Speed (min ⁻¹)	Feed Rate (mm/min)	a_p Axial Depth (mm)	a_e Radial Depth (mm)	
UDC Series	4002	0.2	0.3	27,000	620	0.005	0.05	27,000	500	0.003	0.04	27,000	390	0.003	0.01
			0.5	24,000	500	0.005	0.05	24,000	410	0.003	0.04	24,000	250	0.003	0.01
			1	21,000	380	0.004	0.05	21,000	320	0.002	0.04	21,000	110	0.002	0.009
			1.5	18,000	260	0.004	0.05	18,000	240	0.002	0.03	18,000	80	0.002	0.007
			2	15,000	140	0.004	0.05	15,000	160	0.002	0.03	15,000	60	0.002	0.007
CBN Series	4003	0.3	0.3	24,500	660	0.01	0.075	23,700	530	0.006	0.07	20,000	330	0.003	0.028
			0.5	23,300	600	0.008	0.075	22,500	490	0.006	0.07	18,500	270	0.003	0.028
			1	20,400	460	0.006	0.075	19,500	400	0.005	0.07	17,000	180	0.003	0.028
			1.5	17,500	320	0.004	0.05	16,500	310	0.005	0.07	16,000	140	0.003	0.025
			2	14,600	180	0.004	0.05	13,500	220	0.005	0.07	14,500	100	0.003	0.025
Square	4004	0.4	0.5	25,400	870	0.015	0.12	22,500	750	0.011	0.1	16,200	360	0.003	0.05
			1	22,600	700	0.012	0.12	20,500	600	0.009	0.1	15,000	250	0.003	0.045
			1.5	21,200	610	0.01	0.12	19,500	520	0.008	0.095	14,400	150	0.003	0.043
			2	19,800	530	0.009	0.12	18,500	450	0.007	0.09	13,800	100	0.003	0.04
			2	19,300	610	0.013	0.155	18,000	530	0.01	0.12	12,300	170	0.003	0.06
Long Neck Square	4005	0.5	1	22,000	800	0.017	0.155	20,000	670	0.012	0.125	13,500	300	0.003	0.065
			2	19,300	610	0.013	0.155	18,000	530	0.01	0.12	12,300	170	0.003	0.06
			2	21,300	900	0.018	0.17	19,000	750	0.015	0.145	11,500	240	0.003	0.083
			4	18,600	690	0.013	0.17	15,500	520	0.013	0.14	10,300	50	0.003	0.07
			2	20,000	1,100	0.025	0.2	18,500	950	0.02	0.2	10,000	280	0.005	0.12
Radius	4006	0.6	3	18,800	950	0.021	0.2	16,500	830	0.018	0.2	9,200	200	0.005	0.116
			4	17,500	840	0.018	0.2	15,000	730	0.016	0.2	8,800	120	0.004	0.112
			6	14,600	700	0.015	0.2	12,500	600	0.015	0.2	8,500	60	0.004	0.108
			8	13,100	450	0.008	0.13	11,150	425	0.008	0.125	7,500	50	0.003	0.057
			2	17,600	1,470	0.056	0.27	15,300	1,200	0.038	0.27	10,900	710	0.03	0.27
Long Neck Radius	4008	0.8	3	15,500	1,390	0.048	0.27	13,200	1,150	0.037	0.27	9,400	680	0.027	0.27
			4	13,800	1,310	0.039	0.27	12,000	1,070	0.031	0.243	8,500	640	0.015	0.243
			5	12,500	1,150	0.03	0.24	11,000	960	0.027	0.232	7,800	570	0.013	0.144
			6	11,300	1,040	0.021	0.216	9,800	860	0.016	0.209	7,000	510	0.01	0.108
			8	9,800	780	0.02	0.189	8,500	720	0.012	0.16	6,100	420	0.008	0.094
Ball / Long Shark Ball	4010	1	10	8,800	510	0.011	0.126	7,600	510	0.009	0.1	5,400	350	0.006	0.05
			12	8,100	320	0.008	0.1	7,000	400	0.006	0.05	5,000	300	0.006	0.03
			16	7,000	150	0.005	0.06	6,100	330	0.006	0.05	4,300	250	0.005	0.01
			4	13,200	1,360	0.032	0.45	11,900	1,100	0.024	0.3	9,200	1,300	0.02	0.2
			6	11,200	1,160	0.028	0.36	9,600	980	0.022	0.252	7,400	1,200	0.011	0.095
Ball	4012	1.2	10	9,000	800	0.017	0.18	7,300	600	0.009	0.15	6,300	800	0.006	0.05
			3	16,400	1,520	0.063	0.569	14,800	1,330	0.052	0.54	11,200	780	0.035	0.315
			4	13,200	1,360	0.054	0.54	13,200	1,280	0.042	0.495	10,100	700	0.033	0.292
			6	11,600	1,280	0.041	0.486	10,600	1,210	0.038	0.445	8,100	460	0.025	0.202
			8	10,200	1,080	0.037	0.378	9,300	1,020	0.031	0.346	7,100	390	0.015	0.157
Taper Neck Ball	4015	1.5	10	9,300	930	0.032	0.345	8,500	870	0.029	0.316	6,600	340	0.011	0.172
			12	8,500	830	0.029	0.324	7,800	780	0.026	0.297	5,900	300	0.01	0.162
			16	7,400	670	0.018	0.216	6,800	600	0.014	0.198	5,100	230	0.005	0.108
			18	6,000	550	0.015	0.2	5,800	420	0.01	0.15	4,200	150	0.005	0.08
			8	10,700	1,120	0.047	0.495	9,800	1,060	0.043	0.497	7,700	500	0.02	0.222
Taper	4018	1.8	10	9,600	1,010	0.04	0.436	8,900	950	0.038	0.421	7,100	390	0.015	0.203
			12	8,100	850	0.035	0.303	7,500	740	0.032	0.306	5,900	290	0.013	0.159
			14	7,400	770	0.027	0.24	6,900	660	0.024	0.24	5,400	270	0.008	0.13
			16	7,200	730	0.021	0.207	6,700	630	0.019	0.198	5,200	260	0.006	0.113
			Technical Data												

Milling Conditions for HLRS (4 Flutes)

WORK MATERIAL			PREHARDENED STEELS HARDENED STEELS NAK / SKD (30~45HRC)				HARDENED STEELS SKD / SKT (45~55HRC)				HARDENED STEELS SKD / SKH (55~65HRC)			
Model Number	Outside Diameter (mm)	Effective Length (mm)	Spindle Speed (min ⁻¹)	Feed Rate (mm/min)	a_p Axial Depth (mm)	a_r Radial Depth (mm)	Spindle Speed (min ⁻¹)	Feed Rate (mm/min)	a_p Axial Depth (mm)	a_r Radial Depth (mm)	Spindle Speed (min ⁻¹)	Feed Rate (mm/min)	a_p Axial Depth (mm)	a_r Radial Depth (mm)
4020	2	4	15,300	1,570	0.069	0.72	14,300	1,460	0.065	0.81	11,500	860	0.031	0.36
		6	12,800	1,280	0.064	0.648	12,000	1,200	0.06	0.729	9,700	700	0.028	0.324
		8	11,200	1,160	0.058	0.612	10,400	1,100	0.055	0.648	8,400	600	0.026	0.288
		10	10,000	1,090	0.049	0.526	9,300	1,020	0.047	0.526	7,600	450	0.019	0.234
		12	9,100	1,030	0.046	0.405	8,500	960	0.044	0.405	6,900	420	0.018	0.18
		16	7,800	860	0.042	0.283	7,300	700	0.039	0.315	5,900	270	0.016	0.157
		20	7,000	800	0.025	0.198	6,600	650	0.024	0.198	5,300	290	0.007	0.118
		24	6,500	740	0.02	0.17	5,600	500	0.019	0.14	4,700	270	0.007	0.1
		26	6,000	680	0.013	0.15	5,000	440	0.012	0.12	4,000	220	0.005	0.08
30	5,500	620	0.01	0.1	4,400	390	0.009	0.09	3,400	180	0.005	0.08		
4025	2.5	6	13,000	1,600	0.078	0.7	12,000	1,500	0.074	0.7	9,900	830	0.05	0.476
		8	11,300	1,430	0.075	0.62	10,500	1,240	0.072	0.62	9,100	650	0.05	0.42
		10	10,500	1,400	0.067	0.54	10,000	1,150	0.067	0.54	8,400	510	0.048	0.324
		16	8,900	1,400	0.059	0.36	8,500	790	0.049	0.3	7,200	350	0.03	0.15
		20	7,800	1,200	0.048	0.27	7,500	670	0.031	0.225	6,300	300	0.022	0.09
30	6,300	600	0.011	0.18	6,000	500	0.014	0.18	5,000	220	0.01	0.054		
4030	3	4	15,000	3,070	0.128	0.72	14,000	2,640	0.08	0.72	11,500	980	0.052	0.576
		6	14,000	2,890	0.12	0.72	13,300	2,500	0.075	0.72	10,800	900	0.05	0.576
		8	12,500	2,530	0.105	0.7	11,800	2,200	0.07	0.7	9,900	810	0.047	0.56
		10	11,300	2,160	0.096	0.7	10,500	2,090	0.06	0.7	9,000	730	0.045	0.56
		12	10,500	2,020	0.084	0.67	10,000	1,950	0.052	0.67	8,100	660	0.037	0.502
		14	9,700	1,800	0.072	0.65	9,300	1,700	0.044	0.65	7,500	600	0.032	0.43
		16	9,200	1,680	0.064	0.63	8,800	1,600	0.04	0.63	7,100	570	0.027	0.378
		18	8,600	1,610	0.061	0.605	8,300	1,540	0.038	0.605	6,700	560	0.023	0.348
		20	8,400	1,540	0.058	0.58	7,900	1,490	0.036	0.58	6,300	550	0.022	0.319
		24	7,900	1,490	0.052	0.513	7,500	1,420	0.029	0.513	6,000	510	0.017	0.258
		26	7,500	1,440	0.046	0.446	7,100	1,360	0.023	0.446	5,700	480	0.012	0.198
		30	7,000	1,260	0.04	0.38	6,500	1,230	0.015	0.38	5,400	390	0.007	0.144
		36	6,500	1,100	0.035	0.3	6,100	1,110	0.01	0.18	5,100	300	0.005	0.1
4040	4	8	10,200	1,480	0.133	1.35	8,500	1,420	0.104	1.35	7,300	810	0.091	0.945
		12	8,900	1,440	0.116	1.15	7,600	1,390	0.091	1.15	6,400	780	0.065	0.805
		14	8,500	1,400	0.1	1.08	7,100	1,350	0.078	1.08	6,000	760	0.051	0.76
		16	7,900	1,370	0.091	1	6,600	1,330	0.071	1	5,600	740	0.043	0.7
		20	6,900	1,320	0.076	0.9	5,800	1,260	0.059	0.9	4,900	720	0.032	0.63
		24	6,200	1,200	0.06	0.8	5,200	1,120	0.047	0.8	4,500	630	0.022	0.56
		32	5,500	960	0.037	0.648	4,600	920	0.029	0.648	3,900	600	0.011	0.388
		40	5,000	790	0.025	0.55	4,300	800	0.02	0.482	3,600	560	0.008	0.3
		48	4,600	700	0.012	0.45	3,900	680	0.01	0.315	3,300	500	0.005	0.1
4050	5	16	7,200	1,700	0.15	1.5	5,300	1,200	0.125	1.15	4,200	820	0.063	1.03
		20	6,700	1,500	0.14	1.4	4,800	1,100	0.1	1.1	4,000	740	0.045	1
		40	4,600	880	0.068	1	3,300	700	0.06	0.68	2,800	500	0.025	0.44
4060	6	12	8,000	2,370	0.2	2.43	4,700	1,360	0.2	1.35	4,000	1,080	0.075	1.35
		16	6,700	2,020	0.19	2.394	4,000	1,150	0.19	1.33	3,400	900	0.073	1.33
		18	6,300	1,890	0.185	2.376	3,750	1,060	0.185	1.32	3,200	830	0.071	1.32
		20	5,800	1,730	0.18	2.358	3,500	1,000	0.18	1.31	3,000	760	0.07	1.31
		24	5,200	1,540	0.17	2.322	3,100	860	0.17	1.29	2,700	680	0.068	1.29
		30	4,500	1,290	0.158	2.268	2,600	740	0.158	1.26	2,200	580	0.066	1.26
		40	3,000	800	0.1	1.35	1,700	480	0.1	0.75	1,400	360	0.04	0.55
48	2,000	510	0.05	0.9	1,200	330	0.04	0.5	1,000	240	0.02	0.3		

4 Flutes

UDC Series

CBN Series

Square

Long Neck Square

Radius

Long Neck Radius

Taper Neck Radius

Ball / Long Shank Ball

Long Neck Ball

Taper Neck Ball

Taper

Spiral V Cutter

Drill

EURO Series

Technical Data

Side Milling

a_p : Axial Depth (mm)

a_e : Radial Depth (mm)

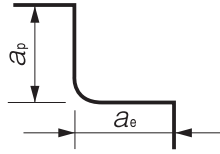

Note:

- Decrease both spindle speed and feed rate proportionally when the milling parameters exceed the machine's maximum spindle speed.
- Every coolant offers stable milling.
- Recommend oil coolant for Stainless Steels and Heat Resistant Alloys.
- Recommend wet coolant for Copper.

UDC Series

CBN Series

Square

Long Neck Square

Radius

Long Neck Radius

Taper Neck Radius

Ball / Long Shank Ball

Long Neck Ball

Taper Neck Ball

Taper

Spiral V Cutter

Drill

EURO Series

Technical Data

Feature 1 : Variable pitch

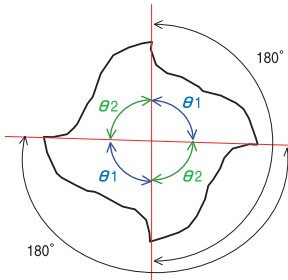

$\theta 1 > \theta 2$: The unequal division reduces chattering and tip damage.
 $\theta 1 + \theta 2 = 180^\circ$: Easy to measure outside diameter.

Feature 2 : Back taper geometry

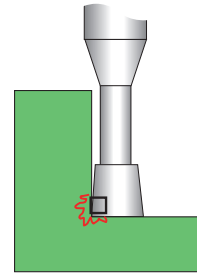

The back taper geometry reduces cutting resistance, which enables stable milling on vertical walls.

Milling Example for Deep Milling

HLRS4000 $\phi 2 \times CRO.3 \times$ Effective Length 16 ($L / D = 8$)

DAC10 (48HRC)

Tool	HLRS 4020-03-160
Spindle Speed	7,300 min^{-1}
Feed Rate	1,260 mm/min
Axial Depth a_p	0.02 mm
Radial Depth a_e	0.015 mm
Cycle Time	112 min
Coolant	Oil Mist
Work Size	20 \times 15 mm

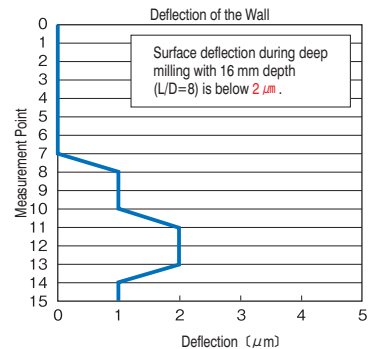
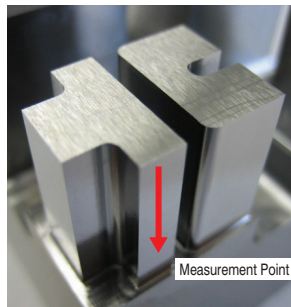

4 Flutes

UDC Series

CBN Series

Square

Long Neck Square

Radius

Radius

Radius

Long Neck Radius

Radius

Taper Neck Radius

Ball / Long Shank Ball

Ball / Long Shank Ball

Ball

Long Neck Ball

Long Neck Ball

Taper Neck Ball

Taper Neck Ball

Taper

Taper

Spiral V Cutter

Spiral V Cutter

Drill

Drill

EURO Series

EURO Series

Technical Data

Technical Data



Size $\phi 2 \sim \phi 12$

HRRS

Super
MG

HARD
MAX

45°

R

± 0.01

± 0.015

Shank Dia
0/-0.005

Back Taper
Geometry

Variable
Pitch

$\phi 2 \sim \phi 6$ $\phi 8 \sim \phi 12$

Material Applications (☆ Highly Recommended ● Recommended ○ Suggested)

Work Material															
Carbon Steels S45C S55C	Alloy Steels SK / SCM SUS	Prehardened Steels NAK HPM	Hardened Steels			Cast Iron	Aluminum Alloys	Graphite	Copper	Plastics	Glass Filled Plastics	Titanium Alloys	Heat Resistant Alloys	Cemented Carbide	Hard Brittle (Non-Metallic) Materials
			~55HRC	~60HRC	~70HRC										
		●	●	●	○	○									

Features

Special corner radius geometry offers greater milling amount and larger step over than a ball design. Seamless corner radius reduces cutting resistance and chattering. Suitable for milling hard materials up to 65HRC.

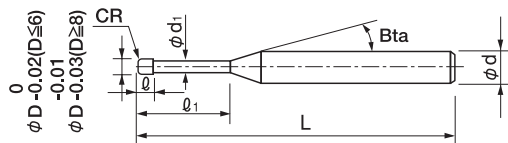

The shank taper angle shown is not an exact value and to avoid contact with the work piece, we recommend the user controls the precise value of this angle. Shank taper angle should not make contact with the work piece.

Total 49 models

Unit (mm)

Model Number	Outside Diameter ϕD	Corner Radius CR	Effective Length ℓ_1	Length of Cut ℓ	Neck Diameter ϕd_1	Shank Taper Angle Bta	Overall Length L	Shank Diameter ϕd	Price ¥			
HRRS 4020-03-06	2	RO.3	6	2	1.91	16°	70	4	10,500			
HRRS 4020-05-06		RO.5					70	4	10,500			
HRRS 4030-08-09-3	3	RO.8	9	3	2.92	—	70	3	9,800			
HRRS 4030-08-09						16°	70	6	10,800			
HRRS 4040-03-12-6	4	RO.3	12	4	3.82	16°	70	6	11,600			
HRRS 4040-03-20-6			20				70	6	12,760			
HRRS 4040-05-12			12				4	3.82	—	70	4	10,000
HRRS 4040-05-12-6									16°	70	6	11,600
HRRS 4040-05-20-6		20	70	6	12,760							
HRRS 4040-10-12		12	R1	4	3.82	—	70	4	10,000			
HRRS 4040-10-12-6						16°	70	6	11,600			
HRRS 4040-10-20-6							70	6	12,760			

Next Page ➡

Unit (mm)

Model Number	Outside Diameter ϕD	Corner Radius CR	Effective Length ℓ_1	Length of Cut ℓ	Neck Diameter ϕd_1	Shank Taper Angle β	Overall Length L	Shank Diameter ϕd	Price ¥
HRRS 4050-12-15	5	R1.2	15	5	4.82	16°	70	6	12,000
HRRS 4060-03-18	6	R0.3	18	6	5.82	—	90	6	13,400
HRRS 4060-03-30			30				90	6	14,740
HRRS 4060-05-18		R0.5	18				90	6	13,400
HRRS 4060-05-30			30				90	6	14,740
HRRS 4060-10-18		R1	18				90	6	13,400
HRRS 4060-10-30			30				90	6	14,740
HRRS 4060-15-18		R1.5	18				90	6	13,400
HRRS 4060-15-30			30				90	6	14,740
HRRS 4060-20-18		R2	18				90	6	13,400
HRRS 4080-03-24		8	R0.3				24	8	7.82
HRRS 4080-03-40	40			100	8	18,370			
HRRS 4080-05-24	R0.5		24	100	8	16,700			
HRRS 4080-05-40			40	100	8	18,370			
HRRS 4080-10-24	R1		24	100	8	16,700			
HRRS 4080-10-40			40	100	8	18,370			
HRRS 4080-20-24	R2		24	100	8	16,700			
HRRS 4080-20-40			40	100	8	18,370			
HRRS 4080-30-24	R3		24	100	8	16,700			
HRRS 4100-03-30	10		R0.3	30	10	9.82	—		
HRRS 4100-03-50		50		110				10	24,200
HRRS 4100-05-30		R0.5	30	110				10	22,000
HRRS 4100-05-50			50	110				10	24,200
HRRS 4100-10-30		R1	30	110				10	22,000
HRRS 4100-10-50			50	110				10	24,200
HRRS 4100-20-30		R2	30	110				10	22,000
HRRS 4100-20-50			50	110				10	24,200
HRRS 4100-30-30		R3	30	110				10	22,000
HRRS 4120-03-36		12	R0.3	36				12	11.82
HRRS 4120-03-60	60			120	12	30,470			
HRRS 4120-05-36	R0.5		36	120	12	27,700			
HRRS 4120-05-60			60	120	12	30,470			
HRRS 4120-10-36	R1		36	120	12	27,700			
HRRS 4120-10-60			60	120	12	30,470			
HRRS 4120-20-36	R2		36	120	12	27,700			
HRRS 4120-20-60			60	120	12	30,470			
HRRS 4120-40-36	R4		36	120	12	27,700			

4 Flutes

UDC Series

CBN Series

Square
Long Neck Square

Radius

Radius
Long Neck Radius

Taper Neck Radius

Ball / Long Shank Ball

Ball
Long Neck Ball

Taper Neck Ball

Taper

Spiral V Cutter

Drill

EURO Series

Technical Data

Milling Conditions for HRRS / HRRS-S

◆Roughing Effective length 3D

WORK MATERIAL			PREHARDENED STEELS / HARDENED STEELS (30~45HRC) (Air Blow / Oil Mist)				HARDENED STEELS (45~55HRC) (Air Blow / Oil Mist)				HARDENED STEELS (55~65HRC) (Air Blow / Oil Mist)			
Model Number	Outside Diameter (mm)	Corner Radius (mm)	Spindle Speed (min ⁻¹)	Feed Rate (mm/min)	a _p Axial Depth (mm)	a _e Radial Depth (mm)	Spindle Speed (min ⁻¹)	Feed Rate (mm/min)	a _p Axial Depth (mm)	a _e Radial Depth (mm)	Spindle Speed (min ⁻¹)	Feed Rate (mm/min)	a _p Axial Depth (mm)	a _e Radial Depth (mm)
UDC Series	2	R0.3	30,000	7,650	0.03	0.41	10,000	2,160	0.08	0.36	8,000	1,170	0.04	0.36
		R0.5	30,000	7,650	0.05	0.72	10,000	2,160	0.14	0.63	8,000	1,170	0.07	0.63
		R0.8	25,000	8,100	0.07	1.08	10,000	2,970	0.16	0.95	7,000	1,710	0.09	0.95
CBN Series	3	R0.3	15,000	8,550	0.05	0.66	9,000	3,600	0.08	0.62	6,000	2,160	0.04	0.62
		R0.5	15,000	8,550	0.06	0.82	9,000	3,600	0.1	0.77	6,000	2,160	0.05	0.77
		R1	15,000	8,550	0.11	1.44	9,000	3,600	0.16	1.35	6,000	2,160	0.09	1.35
Square	4	R0.3	10,000	8,550	0.16	1.8	8,000	4,950	0.18	1.58	6,000	2,160	0.14	1.58
		R0.5	9,000	8,550	0.08	0.98	8,000	5,400	0.09	0.87	6,000	2,070	0.08	0.87
		R0.5	9,000	8,550	0.1	1.23	8,000	5,400	0.11	1.08	6,000	2,070	0.11	1.08
Long Neck Square	5	R1	9,000	8,550	0.14	1.57	8,000	5,400	0.14	1.49	6,000	2,070	0.14	1.49
		R1.5	9,000	8,550	0.17	2.16	8,000	5,400	0.18	1.89	6,000	2,070	0.18	1.89
		R2	9,000	8,550	0.17	2.3	8,000	5,400	0.18	2.02	6,000	2,070	0.18	2.02
Radius	6	R0.3	7,000	8,550	0.03	1.2	6,000	5,850	0.04	1.04	4,000	2,070	0.03	1.04
		R0.5	7,000	8,550	0.04	1.5	6,000	5,850	0.05	1.3	4,000	2,070	0.04	1.3
		R1	7,000	8,550	0.05	1.92	6,000	5,850	0.06	1.8	4,000	2,070	0.05	1.8
Long Neck Radius	8	R2	7,000	8,550	0.21	2.88	6,000	5,850	0.23	2.52	4,000	2,070	0.18	2.52
		R3	7,000	8,550	0.21	3.09	6,000	5,850	0.23	2.7	4,000	2,070	0.18	2.7
		R0.3	6,000	8,550	0.03	1.6	5,000	5,580	0.04	1.3	3,000	2,160	0.03	1.3
Radius	10	R0.5	6,000	8,550	0.04	2	5,000	5,580	0.05	1.62	3,000	2,160	0.04	1.62
		R1	6,000	8,550	0.06	2.57	5,000	5,580	0.07	2.25	3,000	2,160	0.05	2.25
		R2	6,000	8,550	0.24	3.6	5,000	5,580	0.27	3.15	3,000	2,160	0.18	3.15
Long Neck Radius	12	R3	6,000	8,550	0.24	3.86	5,000	5,580	0.27	3.38	3,000	2,160	0.18	3.38
		R0.3	5,000	8,550	0.04	1.93	4,000	7,290	0.04	1.56	2,000	2,250	0.03	1.56
		R0.5	5,000	8,550	0.05	2.41	4,000	7,290	0.05	1.94	2,000	2,250	0.04	1.94
Taper Neck Radius	12	R1	5,000	8,550	0.07	3.09	4,000	7,290	0.07	2.7	2,000	2,250	0.05	2.7
		R2	5,000	8,550	0.27	4.32	4,000	7,290	0.27	3.78	2,000	2,250	0.18	3.78
		R4	5,000	8,550	0.27	4.63	4,000	7,290	0.27	4.05	2,000	2,250	0.18	4.05

When using an effective length of 5D, or the protruding tool experiences an "overhang", then pay attention to the tool overhang coefficient below while referring to the milling parameter table.

*Effective Length 5D: Effective Length (ℓ) ÷ Diameter (φD) = 5

D: φ2.0~3.0

Overhang Length L/D	Spindle Speed (min ⁻¹)	Feed Rate (mm/min)	Axial Depth (mm)	Radial Depth (mm)
~φD×6	×1	×1	×1	×1
~φD×7	×0.8	×0.8	×0.8	×0.9
~φD×8	×0.7	×0.7	×0.7	×0.9
~φD×9	×0.7	×0.7	×0.6	×0.8
~φD×10	×0.6	×0.6	×0.6	×0.7

D: φ8.0~12.0

Overhang Length L/D	Spindle Speed (min ⁻¹)	Feed Rate (mm/min)	Axial Depth (mm)	Radial Depth (mm)
~φD×4	×1	×1	×1	×1
~φD×5	×0.7	×0.7	×0.7	×0.8
~φD×6	×0.5	×0.5	×0.6	×0.7

D: φ4.0~6.0

Overhang Length L/D	Spindle Speed (min ⁻¹)	Feed Rate (mm/min)	Axial Depth (mm)	Radial Depth (mm)
~φD×4	×1	×1	×1	×1
~φD×5	×0.9	×0.9	×0.9	×0.9
~φD×6	×0.8	×0.8	×0.8	×0.9
~φD×7	×0.7	×0.7	×0.6	×0.8
~φD×8	×0.5	×0.5	×0.6	×0.7

D: Outside Diameter (mm) L: Overhang Length (mm)

Milling Conditions for HRRS / HRRS-S

◆ Finishing (flat / inclined surface) Effective length 3D

WORK MATERIAL			PREHARDENED STEELS / HARDENED STEELS (30~45HRC) (Air Blow / Oil Mist)				HARDENED STEELS (45~55HRC) (Air Blow / Oil Mist)				HARDENED STEELS (55~65HRC) (Air Blow / Oil Mist)			
Model Number	Outside Diameter (mm)	Corner Radius (mm)	Spindle Speed (min ⁻¹)	Feed Rate (mm/min)	a_p Axial Depth (mm)	a_e Radial Depth (mm)	Spindle Speed (min ⁻¹)	Feed Rate (mm/min)	a_p Axial Depth (mm)	a_e Radial Depth (mm)	Spindle Speed (min ⁻¹)	Feed Rate (mm/min)	a_p Axial Depth (mm)	a_e Radial Depth (mm)
4020-03-06	2	R0.3	30,000	850	0.1	0.03	10,000	355	0.1	0.04	8,000	240	0.05	0.03
4020-05-06		R0.5	30,000	1,100	0.1	0.04	10,000	460	0.1	0.05	8,000	310	0.05	0.04
4030-08-09	3	R0.8	25,000	1,100	0.1	0.04	10,000	650	0.1	0.07	7,000	350	0.05	0.05
4040-03-12-6		R0.3	15,000	620	0.08	0.04	9,000	365	0.08	0.04	6,000	205	0.04	0.03
4040-05-12	4	R0.5	15,000	775	0.1	0.05	9,000	455	0.1	0.05	6,000	255	0.05	0.04
4040-10-12		R1	15,000	1,100	0.1	0.07	9,000	650	0.1	0.07	6,000	360	0.05	0.06
4050-12-15	5	R1.2	10,000	1,100	0.1	0.11	8,000	650	0.1	0.08	6,000	360	0.05	0.06
4060-03-18		R0.3	9,000	550	0.16	0.06	8,000	300	0.16	0.04	6,000	170	0.08	0.03
4060-05-18	6	R0.5	9,000	690	0.2	0.08	8,000	375	0.2	0.05	6,000	215	0.1	0.04
4060-10-18		R1	9,000	975	0.2	0.11	8,000	530	0.2	0.07	6,000	310	0.1	0.05
4060-15-18	6	R1.5	9,000	1,200	0.2	0.13	8,000	650	0.2	0.08	6,000	380	0.1	0.06
4060-20-18		R2	9,000	1,385	0.2	0.15	8,000	750	0.2	0.09	6,000	435	0.1	0.07
4080-03-24	7	R0.3	7,000	480	0.04	0.07	6,000	260	0.04	0.05	4,000	145	0.04	0.05
4080-05-24		R0.5	7,000	598	0.05	0.09	6,000	322	0.05	0.06	4,000	184	0.05	0.06
4080-10-24	8	R1	7,000	845	0.05	0.12	6,000	455	0.05	0.08	4,000	265	0.05	0.07
4080-20-24		R2	7,000	1,200	0.2	0.17	6,000	650	0.2	0.11	4,000	380	0.1	0.1
4080-30-24	8	R3	7,000	1,465	0.2	0.21	6,000	795	0.2	0.13	4,000	465	0.1	0.12
4100-03-30		R0.3	6,000	478	0.04	0.08	5,000	258	0.04	0.05	3,000	147	0.04	0.06
4100-05-30	9	R0.5	6,000	598	0.05	0.1	5,000	322	0.05	0.06	3,000	184	0.05	0.07
4100-10-30		R1	6,000	845	0.05	0.14	5,000	455	0.05	0.09	3,000	265	0.05	0.09
4100-20-30	10	R2	6,000	1,200	0.2	0.2	5,000	650	0.2	0.13	3,000	380	0.1	0.13
4100-30-30		R3	6,000	1,470	0.2	0.25	5,000	795	0.2	0.16	3,000	465	0.1	0.16
4120-03-36	11	R0.3	5,000	480	0.04	0.1	4,000	260	0.04	0.07	2,000	145	0.04	0.09
4120-05-36		R0.5	5,000	598	0.05	0.12	4,000	322	0.05	0.08	2,000	184	0.05	0.1
4120-10-36	12	R1	5,000	845	0.05	0.17	4,000	455	0.05	0.11	2,000	265	0.05	0.13
4120-20-36		R2	5,000	1,200	0.2	0.24	4,000	650	0.2	0.16	2,000	380	0.1	0.19
4120-40-36	12	R4	5,000	1,695	0.2	0.34	4,000	915	0.2	0.23	2,000	535	0.1	0.27

When using an effective length of 5D, or the protruding tool experiences an "overhang", then pay attention to the tool overhang coefficient found on page 364 while referring to the milling parameter table.

*Effective Length 5D: Effective Length (ℓ_e) ÷ Diameter (ϕD) = 5

Roughing Parameter

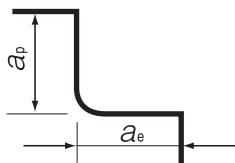

a_p : Axial Depth (mm)
 a_e : Radial Depth (mm)

Finishing Parameter
 (Flat / Inclined Surface)

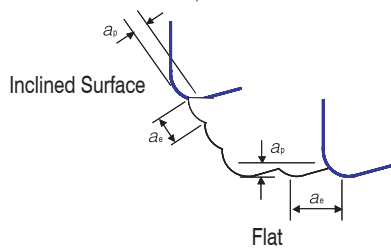

Note:

- Decrease both spindle speed and feed rate proportionally when the milling parameters exceed the machine's maximum spindle speed.
- Decrease the feed rate more than 50% from the milling parameters when slot milling.
- Only adjust the spindle speed when calculate milling conditions based on the overhang length in finishing process.
- Recommend air blow or oil mist.

4 Flutes

UDC Series

CBN Series

Square

Long Neck Square

Radius

Long Neck Radius

Taper Neck Radius

Ball / Long Shank Ball

Long Neck Ball

Taper Neck Ball

Taper

Spiral V Cutter

Drill

EURO Series

Technical Data

Flat Milling Example: Milling with HRRS $\phi 12$ x CR4

SKD11 (60HRC)

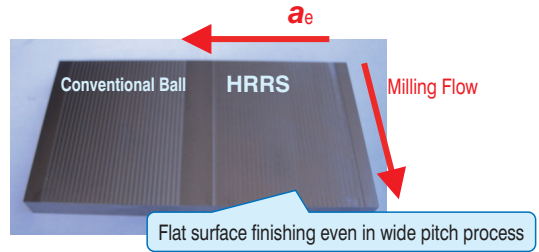
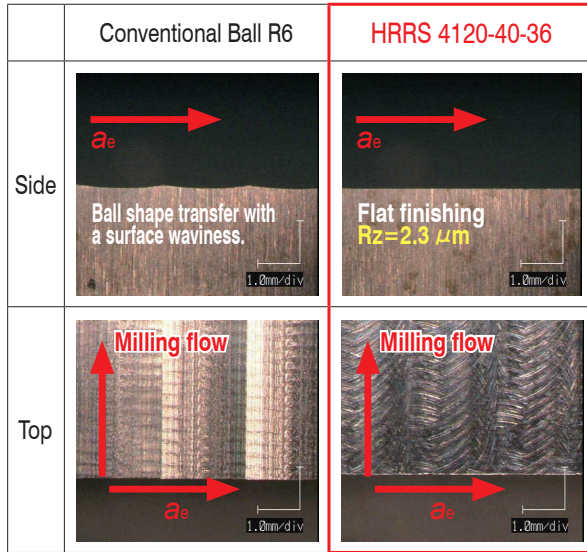

HRRS Surface Roughness
Maximum Surface Roughness (calculated value) = 2.375 μm

Spindle Speed	Feed Rate	a_p Axial Depth	a_e Radial Depth	Milling Distance	Overhang Length
2,000 min^{-1}	535 mm/min	0.1 mm	2 mm	100 mm \times 35 Times	55 mm

HRRS Series
NAK80 (40HRC)
Milling Video



HRRS Series
DH31S (52HRC)
Milling Video







HRRS Series
DH31 (52HRC)
Milling Video

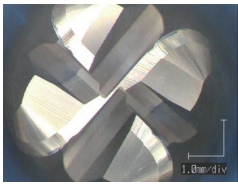
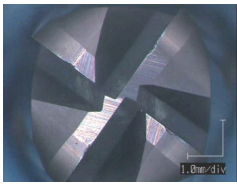
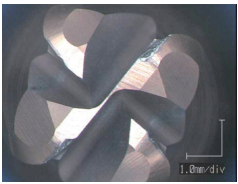
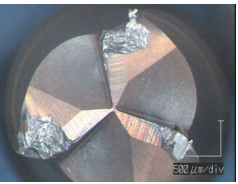
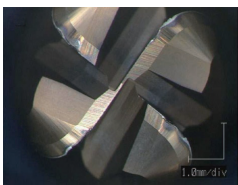

- UDC Series
- CBN Series
- Square
- Long Neck Square
- Radius
- Long Neck Radius
- Taper Neck Radius
- Ball / Long Shark Ball
- Long Neck Ball
- Taper Neck Ball
- Taper
- Spiral V Cutter
- Drill
- EURO Series
- Technical Data

Pocket Milling Example: Milling with HRRS $\phi 6 \times CR1.5$

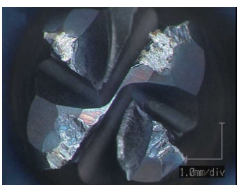
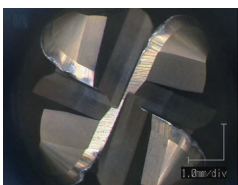
SKD11 (60HRC)

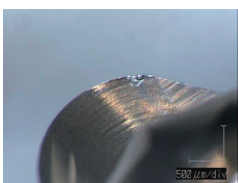
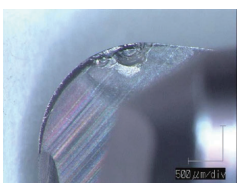
	HRRS	Competitor A: 4 Flutes	Competitor B: 4 Flutes	Competitor B: 3 Flutes
Depth 0.9 mm				
Depth 12.3 mm				Broken
Depth 16.5 mm			Broken  Pocket Milling Cycle Time: 40 min	
				

Spindle Speed	Z helical Approach	Feed Rate	a_p Axial Depth	a_e Radial Depth	Overhang Length	Cycle Time	Coolant
2,700 min ⁻¹	1,350 mm/min	2,000 mm/min	0.3 mm (0.05D)	1.5 mm (0.25D)	20 mm	40 min	Air Blow (Nozzle)

Longer tool life on 60HRC milling.

4 Flutes

UDC Series

CBN Series

Square

Long Neck Square

Radius

Long Neck Radius

Taper Neck Radius

Ball / Long Shank Ball

Long Neck Ball

Taper Neck Ball

Taper

Spiral V Cutter

Drill

EURO Series

Technical Data



Size $\phi 2 \sim \phi 12$

Short Shank Series

HRRS-S



$\phi 2 \sim \phi 6$ $\phi 8 \sim \phi 12$

Material Applications (☆ Highly Recommended ◎ Recommended ○ Suggested)

Work Material															
Carbon Steels S45C S55C	Alloy Steels SK / SCM SUS	Prehardened Steels NAK HPM	Hardened Steels			Cast Iron	Aluminum Alloys	Graphite	Copper	Plastics	Glass Filled Plastics	Titanium Alloys	Heat Resistant Alloys	Cemented Carbide	Hard Brittle (Non-Metallic) Materials
			~55HRC	~60HRC	~70HRC										
		◎	◎	◎	○										
				○											

Features

Shorter overall length and overhang offer higher feed and precision.
Achieves larger step over by seamless corner radius design.
Rated to 65HRC milling. Refer to page 364, 365 for Milling Conditions.

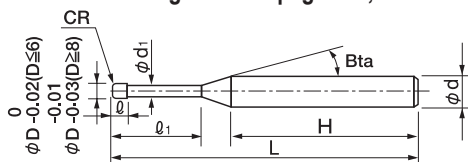

The shank taper angle and the shank length (H) shown are not an exact value and to avoid contact with the work piece, we recommend the user controls the precise value of this angle. Shank taper angle should not make contact with the work piece.

Total 26 models

Unit (mm)

Model Number	Outside Diameter ϕD	Corner Radius CR	Effective Length ℓ_1	Length of Cut ℓ	Neck Diameter ϕd_1	Shank Taper Angle Bta	Overall Length L	Shank Diameter ϕd	Shank Length H	Price ¥
HRRS 4020-03-06S	2	R0.3	6	2	1.91	16°	45	4	33.0	9,450
HRRS 4020-05-06S		R0.5					45			
HRRS 4030-08-09-3S	3	R0.8	9	3	2.92	16°	50	3	38.5	8,820
HRRS 4030-08-09S							50			
HRRS 4040-05-12S	4	R0.5	12	4	3.82	16°	50	4	35.0	9,000
HRRS 4040-05-12-6S							50			
HRRS 4040-10-12S		R1					50	4	35.0	9,000
HRRS 4040-10-12-6S							50			
HRRS 4050-12-15S	5	R1.2	15	5	4.82	16°	50	6	30.0	10,800
HRRS 4060-05-18S	6	R0.5	18	6	5.82	—	50	6	29.0	12,060
HRRS 4060-10-18S		R1					50			
HRRS 4060-15-18S		R1.5					50	6	29.0	12,060
HRRS 4060-20-18S		R2					50			
HRRS 4080-05-24S		R0.5					60			
HRRS 4080-10-24S	8	R1	24	8	7.82	—	60	8	33.0	15,030
HRRS 4080-20-24S		R2					60			
HRRS 4080-30-24S		R3					60			
HRRS 4100-03-30S	10	R0.3	30	10	9.82	—	65	10	31.5	19,800
HRRS 4100-05-30S		R0.5					65			
HRRS 4100-10-30S		R1					65	10	31.5	19,800
HRRS 4100-20-30S		R2					65			
HRRS 4100-30-30S		R3					65			
HRRS 4120-05-36S	12	R0.5	36	12	11.82	—	75	12	35.5	24,930
HRRS 4120-10-36S		R1					75			
HRRS 4120-20-36S		R2					75	12	35.5	24,930
HRRS 4120-40-36S		R4					75			

Pocket Milling Example: Milling with HRRS $\phi 6 \times \text{CR1.5}$

NAK80 (40HRC)

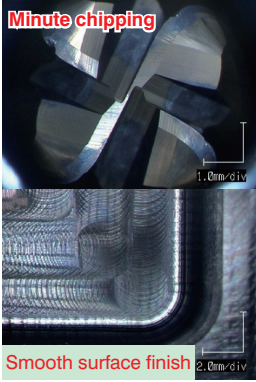
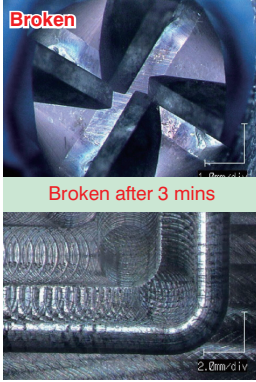
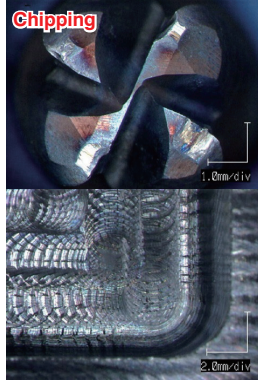
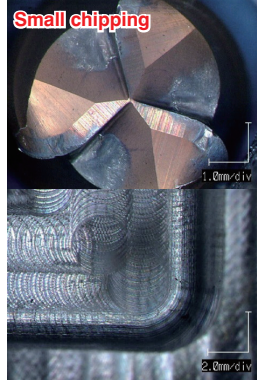
HRRS	Competitor A: 4 Flutes	Competitor B: 4 Flutes	Competitor B: 3 Flutes
			
CR1.5, FL6 mm, EFL18 mm	CR1.5, FL6 mm, EFL18 mm	CR1.5, FL12 mm	CR1.5, FL12 mm

Spindle Speed	Feed Rate	a_p Axial Depth	a_e Radial Depth	Overhang Length	Cycle Time	Pocket Size
9,000 min^{-1}	11,000 mm/min	0.3 mm (0.05D)	3 mm (0.5D)	20 mm	20 min	40 × 180 × Depth 15 mm

Excellent chipping resistance and surface quality !

Original corner radius design offers high rigidity and reduces cutting resistance.

After milling SKD11 (60HRC)

HRRS

Competitor

Competitor

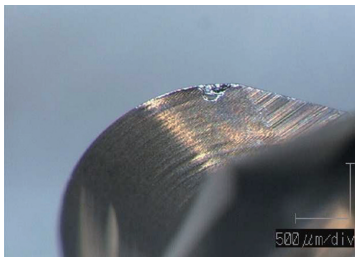

Seamless corner radius with equal rake angle design. Reduces the cutting resistance and offers excellent chip evacuation to protect from the tool damage.

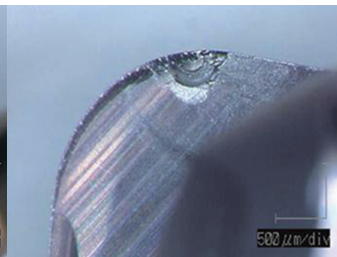

Flat and non-helix gash design. Badly damaged at tip point where cutting chips are trapped by poor chip evacuation.

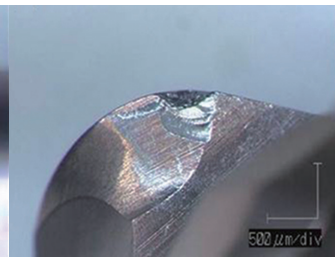

Flat and helical gash design. Huge tool damage at tangent point where the gash shape abruptly changed and cutting chips could not evacuate properly.

Spindle Speed	Feed Rate	a_p Axial Depth	a_e Radial Depth	Overhang Length	Pocket Size
2,700 min^{-1}	2,000 mm/min	0.3 mm	1.5 mm	20 mm	40 × 40 × 0.3 mm

Longer tool life with variable pitch design. Recommended for various coolant.

4 Flutes

UDC Series

CBN Series

Square
Long Neck Square

Radius

Long Neck Radius

Taper Neck Radius

Ball / Long Shank Ball

Ball

Long Neck Ball

Taper Neck Ball

Taper

Spiral V Cutter

Drill

EURO Series

Technical Data



Size $\phi 2 \sim \phi 12$

CRRS



$\phi 2 \sim \phi 6$ $\phi 8 \sim \phi 12$

Material Applications (☆ Highly Recommended ● Recommended ○ Suggested)

Work Material															
Carbon Steels S45C S55C	Alloy Steels SK / SCM SUS	Prehardened Steels NAK HPM	Hardened Steels			Cast Iron	Aluminum Alloys	Graphite	Copper	Plastics	Glass Filled Plastics	Titanium Alloys	Heat Resistant Alloys	Cemented Carbide	Hard Brittle (Non-Metallic) Materials
			~55HRC	~60HRC	~70HRC										
○	○	○	○			○	○		○			○	○		

Features

Broad application range from Copper and Raw Materials to Hardened Steels (55HRC). UTCOAT offers long tool life. Variable pitch, high helix and positive rake angle offer stable milling. Reduced cutting resistance when using a helical approach or inclined angles.

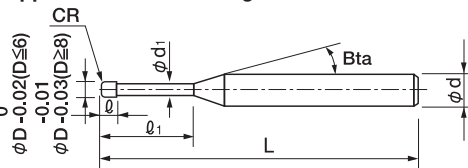

The shank taper angle shown is not an exact value and to avoid contact with the work piece, we recommend the user controls the precise value of this angle. Shank taper angle should not make contact with the work piece.

Total 24 models

Unit (mm)

Model Number	Outside Diameter ϕD	Corner Radius CR	Effective Length ℓ_1	Length of Cut ℓ	Neck Diameter ϕd_1	Shank Taper Angle Bta	Overall Length L	Shank Diameter ϕd	Price ¥
CRRS 4020-05-06	2	RO.5	6	2	1.91	16°	70	4	10,500
CRRS 4030-08-09	3	RO.8	9	3	2.92	16°	70	6	10,800
CRRS 4040-03-12	4	RO.3	12	4	3.82	16°	60	6	11,600
CRRS 4040-05-12-4		RO.5				—	70	4	10,000
CRRS 4040-05-12		R1				16°	60	6	11,600
CRRS 4040-10-12-4						—	70	4	10,000
CRRS 4040-10-12						16°	70	6	11,600
CRRS 4050-12-15	5	R1.2	15	5	4.82	16°	70	6	12,000
CRRS 4060-03-18	6	RO.3	18	6	5.82	—	90	6	13,400
CRRS 4060-05-18		RO.5					60	6	13,400
CRRS 4060-10-18		R1					60	6	13,400
CRRS 4060-15-18		R1.5					90	6	13,400
CRRS 4080-03-24	8	RO.3	24	8	7.82	—	100	8	16,700
CRRS 4080-05-26		RO.5	26				70	8	16,700
CRRS 4080-10-26		R1	26				70	8	16,700
CRRS 4080-20-24		R2	24				100	8	16,700
CRRS 4100-03-30	10	RO.3	30	10	9.82	—	110	10	22,000
CRRS 4100-05-30		RO.5					80	10	22,000
CRRS 4100-10-30		R1					80	10	22,000
CRRS 4100-20-30		R2					110	10	22,000
CRRS 4120-03-36	12	RO.3	36	12	11.82	—	120	12	27,700
CRRS 4120-05-36		RO.5					120	12	27,700
CRRS 4120-10-36		R1					120	12	27,700
CRRS 4120-20-36		R2					120	12	27,700

Milling Conditions for CRRS

◆ Roughing

WORK MATERIAL			CARBON STEELS S45C / S55C (~225HB)				ALLOY STEELS SK / SCM / SUS(225~325HB) *Use cutting oils for Stainless Steels.				PREHARDENED STEELS HARDENED STEELS NAK / HPM / SKD / SKT / STAVAX(30~55HRC) *Recommend oil mist.			
Model Number	Outside Diameter (mm)	Corner Radius (mm)	Spindle Speed (min ⁻¹)	Feed Rate (mm/min)	a _p Axial Depth (mm)	a _e Radial Depth (mm)	Spindle Speed (min ⁻¹)	Feed Rate (mm/min)	a _p Axial Depth (mm)	a _e Radial Depth (mm)	Spindle Speed (min ⁻¹)	Feed Rate (mm/min)	a _p Axial Depth (mm)	a _e Radial Depth (mm)
4020-05-06	2	R0.5	30,000	7,200	0.08	0.8	30,000	7,200	0.04	0.66	24,000	7,000	0.02	0.59
4030-08-09	3	R0.8	20,000	8,400	0.09	1.2	20,000	7,200	0.04	1.08	16,000	7,000	0.04	0.88
4040-03-12	4	R0.3	15,000	9,600	0.09	1.6	15,000	7,200	0.05	1.32	12,000	7,000	0.05	1.17
4040-05-12-4		R0.5	15,000	9,600	0.1	1.6	15,000	7,200	0.05	1.35	12,000	7,000	0.05	1.26
4040-05-12			15,000	9,600	0.1	1.6	15,000	7,200	0.05	1.35	12,000	7,000	0.05	1.26
4040-10-12-4		R1	15,000	9,600	0.11	1.6	15,000	7,200	0.05	1.53	12,000	7,000	0.06	1.33
4040-10-12			15,000	9,600	0.11	1.6	15,000	7,200	0.05	1.53	12,000	7,000	0.06	1.33
4050-12-15	5	R1.2	12,000	10,800	0.13	2	12,000	7,200	0.06	1.8	9,600	6,300	0.06	1.54
4060-03-18	6	R0.3	10,000	12,000	0.13	2.4	10,000	7,200	0.07	1.94	8,000	5,250	0.07	1.63
4060-05-18		R0.5	10,000	12,000	0.14	2.4	10,000	7,200	0.07	1.98	8,000	5,250	0.07	1.75
4060-10-18		R1	10,000	12,000	0.15	2.4	10,000	7,200	0.07	2.16	8,000	5,250	0.08	1.75
4060-15-18		R1.5	10,000	12,000	0.17	2.4	10,000	7,200	0.08	2.34	8,000	5,250	0.11	1.75
4080-03-24		R0.3	7,500	12,000	0.17	2.86	7,500	7,200	0.08	2.76	6,000	4,100	0.15	1.77
4080-05-26	8	R0.5	7,500	12,000	0.18	2.64	7,500	7,200	0.08	2.61	6,000	4,100	0.14	1.76
4080-10-26		R1	7,500	12,000	0.18	2.72	7,500	7,200	0.09	2.7	6,000	4,100	0.16	1.76
4080-20-24		R2	7,500	12,000	0.22	2.88	7,500	7,200	0.1	2.79	6,000	4,100	0.18	1.96
4100-03-30		R0.3	6,000	12,000	0.2	3.04	5,000	5,400	0.14	2.82	4,800	4,100	0.18	1.89
4100-05-30	10	R0.5	6,000	12,000	0.22	3.04	5,000	5,400	0.14	2.88	4,800	4,100	0.18	2.03
4100-10-30		R1	6,000	12,000	0.24	3.28	5,000	5,400	0.14	2.97	4,800	4,100	0.19	2.1
4100-20-30		R2	6,000	12,000	0.26	3.44	5,000	5,400	0.14	3.06	4,800	4,100	0.2	2.45
4120-03-36		R0.3	5,000	12,000	0.21	3.32	3,000	4,320	0.18	2.9	4,000	4,100	0.19	2.15
4120-05-36	12	R0.5	5,000	12,000	0.24	3.32	3,000	4,320	0.18	2.96	4,000	4,100	0.19	2.32
4120-10-36		R1	5,000	12,000	0.26	3.59	3,000	4,320	0.18	3.06	4,000	4,100	0.2	2.4
4120-20-36		R2	5,000	12,000	0.28	3.76	3,000	4,320	0.18	3.15	4,000	4,100	0.21	2.8

WORK MATERIAL			TITANIUM / TITANIUM ALLOYS Ti-6Al-4V				HEAT RESISTANT ALLOYS Inconel718			
Model Number	Outside Diameter (mm)	Corner Radius (mm)	Spindle Speed (min ⁻¹)	Feed Rate (mm/min)	a _p Axial Depth (mm)	a _e Radial Depth (mm)	Spindle Speed (min ⁻¹)	Feed Rate (mm/min)	a _p Axial Depth (mm)	a _e Radial Depth (mm)
4020-05-06	2	R0.5	21,420	4,010	0.03	0.33	5,140	810	0.03	0.33
4030-08-09	3	R0.8	14,280	4,010	0.03	0.54	3,430	810	0.03	0.54
4040-03-12	4	R0.3	10,710	4,010	0.04	0.66	2,570	810	0.04	0.66
4040-05-12-4		R0.5	10,710	4,010	0.04	0.68	2,570	810	0.04	0.68
4040-05-12			10,710	4,010	0.04	0.68	2,570	810	0.04	0.68
4040-10-12-4		R1	10,710	4,010	0.04	0.77	2,570	810	0.04	0.77
4040-10-12			10,710	4,010	0.04	0.77	2,570	810	0.04	0.77
4050-12-15	5	R1.2	8,570	4,010	0.04	0.9	2,060	810	0.04	0.9
4060-03-18	6	R0.3	7,140	4,010	0.05	1	1,740	810	0.05	1
4060-05-18		R0.5	7,140	4,010	0.05	1	1,740	810	0.05	1
4060-10-18		R1	7,140	4,010	0.05	1.08	1,740	810	0.05	1.08
4060-15-18		R1.5	7,140	4,010	0.05	1.08	1,740	810	0.05	1.08
4080-03-24		R0.3	5,360	4,000	0.05	1.28	1,580	800	0.05	1.28
4080-05-26	8	R0.5	5,360	4,000	0.05	1.31	1,580	800	0.05	1.31
4080-10-26		R1	5,360	4,000	0.05	1.35	1,580	800	0.05	1.35
4080-20-24		R2	5,360	4,000	0.05	1.4	1,580	800	0.05	1.4
4100-03-30		R0.3	3,570	3,010	0.09	1.41	1,050	550	0.09	1.41
4100-05-30	10	R0.5	3,570	3,010	0.09	1.44	1,050	550	0.09	1.44
4100-10-30		R1	3,570	3,010	0.09	1.49	1,050	550	0.09	1.49
4100-20-30		R2	3,570	3,010	0.09	1.53	1,050	550	0.09	1.53
4120-03-36		R0.3	2,140	2,400	0.12	1.45	640	410	0.12	1.45
4120-05-36	12	R0.5	2,140	2,400	0.12	1.48	640	410	0.12	1.48
4120-10-36		R1	2,140	2,400	0.12	1.53	640	410	0.12	1.53
4120-20-36		R2	2,140	2,400	0.12	1.58	640	410	0.12	1.58

4 Flutes

UDC Series

CBN Series

Square

Long Neck Square

Radius

Long Neck Radius

Taper Neck Radius

Ball / Long Shank Ball

Long Neck Ball

Taper Neck Ball

Taper

Spiral V Cutter

Drill

EURO Series

Technical Data

Milling Conditions for CRRS

◆Finishing (Flat / Inclined surface)

WORK MATERIAL			CARBON STEELS S45C / S55C (~225HB)				ALLOY STEELS SK / SCM / SUS(225~325HB) *Use cutting oils for Stainless Steels.				PREHARDENED STEELS HARDENED STEELS NAK / HPM / SKD / SKT / STAVAX(30~55HRC) *Recommend oil mist.			
Model Number	Outside Diameter (mm)	Corner Radius (mm)	Spindle Speed (min ⁻¹)	Feed Rate (mm/min)	a _p Axial Depth (mm)	a _e Radial Depth (mm)	Spindle Speed (min ⁻¹)	Feed Rate (mm/min)	a _p Axial Depth (mm)	a _e Radial Depth (mm)	Spindle Speed (min ⁻¹)	Feed Rate (mm/min)	a _p Axial Depth (mm)	a _e Radial Depth (mm)
4020-05-06	2	R0.5	30,000	1,720	0.1	0.06	30,000	1,510	0.05	0.05	24,000	1,070	0.05	0.04
4030-08-09	3	R0.8	20,000	1,890	0.1	0.09	20,000	1,660	0.05	0.08	16,000	1,160	0.05	0.07
4040-03-12	4	R0.3	15,000	1,050	0.1	0.07	15,000	910	0.05	0.06	12,000	620	0.05	0.05
4040-05-12-4		R0.5	15,000	1,360	0.1	0.09	15,000	1,180	0.05	0.08	12,000	810	0.05	0.07
4040-05-12			15,000	1,360	0.1	0.09	15,000	1,180	0.05	0.08	12,000	810	0.05	0.07
4040-10-12-4		R1	15,000	1,920	0.1	0.13	15,000	1,670	0.05	0.11	12,000	1,150	0.05	0.1
4040-10-12			15,000	1,920	0.1	0.13	15,000	1,670	0.05	0.11	12,000	1,150	0.05	0.1
4050-12-15	5	R1.2	12,000	1,910	0.1	0.16	12,000	1,630	0.05	0.14	9,600	1,120	0.05	0.12
4060-03-18	6	R0.3	10,000	890	0.2	0.09	10,000	760	0.1	0.08	8,000	510	0.1	0.06
4060-05-18		R0.5	10,000	1,150	0.2	0.12	10,000	990	0.1	0.1	8,000	670	0.1	0.08
4060-10-18			R1	10,000	1,630	0.2	0.16	10,000	1,400	0.1	0.14	8,000	950	0.1
4060-15-18		R1.5	10,000	2,000	0.2	0.2	10,000	1,720	0.1	0.17	8,000	1,170	0.1	0.15
4080-03-24		R0.3	7,500	1,170	0.2	0.11	7,500	1,050	0.1	0.09	6,000	720	0.1	0.08
4080-05-26	8	R0.5	7,500	990	0.2	0.13	7,500	860	0.1	0.11	6,000	580	0.1	0.1
4080-10-26		R1	7,500	1,410	0.2	0.19	7,500	1,210	0.1	0.16	6,000	830	0.1	0.14
4080-20-24		R2	7,500	1,990	0.2	0.27	7,500	1,720	0.1	0.23	6,000	1,170	0.1	0.2
4100-03-30	10	R0.3	6,000	720	0.2	0.12	5,000	510	0.1	0.1	4,800	400	0.1	0.08
4100-05-30		R0.5	6,000	940	0.2	0.16	5,000	660	0.1	0.13	4,800	520	0.1	0.11
4100-10-30		R1	6,000	1,330	0.2	0.22	5,000	940	0.1	0.19	4,800	740	0.1	0.15
4100-20-30		R2	6,000	1,890	0.2	0.32	5,000	1,340	0.1	0.27	4,800	1,050	0.1	0.22
4120-03-36		12	R0.3	5,000	680	0.2	0.14	3,000	330	0.1	0.1	4,000	360	0.1
4120-05-36	R0.5		5,000	880	0.2	0.18	3,000	430	0.1	0.14	4,000	480	0.1	0.12
4120-10-36	R1		5,000	1,240	0.2	0.24	3,000	610	0.1	0.2	4,000	680	0.1	0.16
4120-20-36	R2		5,000	1,760	0.2	0.35	3,000	870	0.1	0.29	4,000	960	0.1	0.24

WORK MATERIAL			TITANIUM / TITANIUM ALLOYS Ti-6Al-4V				HEAT RESISTANT ALLOYS Inconel718			
Model Number	Outside Diameter (mm)	Corner Radius (mm)	Spindle Speed (min ⁻¹)	Feed Rate (mm/min)	a _p Axial Depth (mm)	a _e Radial Depth (mm)	Spindle Speed (min ⁻¹)	Feed Rate (mm/min)	a _p Axial Depth (mm)	a _e Radial Depth (mm)
4020-05-06	2	R0.5	21,420	840	0.04	0.03	5,140	170	0.04	0.03
4030-08-09	3	R0.8	14,280	920	0.04	0.04	3,430	190	0.04	0.04
4040-03-12	4	R0.3	10,710	510	0.04	0.03	2,570	100	0.04	0.03
4040-05-12-4		R0.5	10,710	660	0.04	0.04	2,570	130	0.04	0.04
4040-05-12			10,710	660	0.04	0.04	2,570	130	0.04	0.04
4040-10-12-4		R1	10,710	930	0.04	0.06	2,570	190	0.04	0.06
4040-10-12			10,710	930	0.04	0.06	2,570	190	0.04	0.06
4050-12-15	5	R1.2	8,570	910	0.03	0.07	2,060	180	0.03	0.07
4060-03-18	6	R0.3	7,140	420	0.07	0.04	1,740	90	0.07	0.04
4060-05-18		R0.5	7,140	550	0.07	0.05	1,740	110	0.07	0.05
4060-10-18			R1	7,140	780	0.07	0.07	1,740	160	0.07
4060-15-18		R1.5	7,140	960	0.06	0.08	1,740	190	0.06	0.08
4080-03-24		R0.3	5,360	400	0.06	0.04	1,580	80	0.06	0.04
4080-05-26	8	R0.5	5,360	480	0.06	0.06	1,580	100	0.06	0.06
4080-10-26		R1	5,360	670	0.06	0.08	1,580	130	0.06	0.08
4080-20-24		R2	5,360	960	0.05	0.12	1,580	190	0.05	0.12
4100-03-30	10	R0.3	3,570	280	0.06	0.05	1,050	50	0.06	0.05
4100-05-30		R0.5	3,570	370	0.06	0.07	1,050	70	0.06	0.07
4100-10-30		R1	3,570	520	0.06	0.1	1,050	100	0.06	0.1
4100-20-30		R2	3,570	750	0.06	0.14	1,050	140	0.06	0.14
4120-03-36		12	R0.3	2,140	240	0.07	0.05	640	40	0.07
4120-05-36	R0.5		2,140	310	0.07	0.07	640	50	0.07	0.07
4120-10-36	R1		2,140	400	0.07	0.11	640	70	0.07	0.12
4120-20-36	R2		2,140	520	0.07	0.17	640	100	0.07	0.17

Milling Conditions for CRRS

Please adjust milling parameter referring following table.

D : Outside Diameter (mm)

L : Overhang Length (mm)

D : $\phi 2.0 \sim 3.0$

Overhang Length L/D	Spindle Speed (min ⁻¹)	Feed Rate (mm/min)	a_p Axial Depth (mm)	a_e Radial Depth (mm)
L/D ≤ 6	× 1	× 1	× 1	× 1
L/D = 7	× 0.8	× 0.8	× 0.8	× 0.9
L/D = 8	× 0.7	× 0.7	× 0.7	× 0.9
L/D = 9	× 0.7	× 0.7	× 0.6	× 0.8
L/D = 10	× 0.6	× 0.6	× 0.6	× 0.7

D : $\phi 4.0 \sim 6.0$

Overhang Length L/D	Spindle Speed (min ⁻¹)	Feed Rate (mm/min)	a_p Axial Depth (mm)	a_e Radial Depth (mm)
L/D ≤ 4	× 1	× 1	× 1	× 1
L/D = 5	× 0.9	× 0.8	× 0.9	× 0.9
L/D = 6	× 0.8	× 0.7	× 0.8	× 0.9
L/D = 7	× 0.7	× 0.6	× 0.6	× 0.8
L/D = 8	× 0.5	× 0.4	× 0.6	× 0.7

D : $\phi 8.0 \sim 12.0$

Overhang Length L/D	Spindle Speed (min ⁻¹)	Feed Rate (mm/min)	a_p Axial Depth (mm)	a_e Radial Depth (mm)
L/D ≤ 4	× 1	× 1	× 1	× 1
L/D = 5	× 0.7	× 0.6	× 0.6	× 0.8
L/D = 6	× 0.5	× 0.4	× 0.5	× 0.7

Note:

- Decrease both spindle speed and feed rate proportionally when the milling parameters exceed the machine's maximum spindle speed.
- Decrease the feed rate more than 50% from the milling parameters when slot milling.
- Only adjust the spindle speed to calculate milling conditions based on the overhang length in finishing process.
- Every coolant offers stable milling.
- Recommend wet coolant for Stainless Steels.

Roughing Parameter

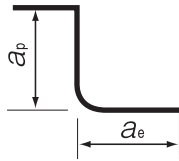

a_p : Axial Depth (mm)
 a_e : Radial Depth (mm)

Finishing Parameter
(Flat / Inclined Surface)

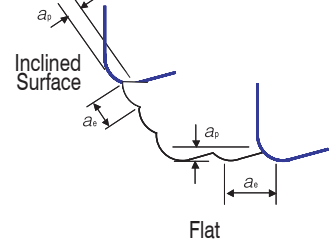

4 Flutes

UDC
Series

CBN
Series

Square

Long Neck
Square

Radius

Long Neck
Radius

Taper Neck
Radius

Ball / Long
Shank Ball

Long Neck
Ball

Taper Neck
Ball

Taper

Spiral
V Cutter

Drill

EURO Series

Technical Data

Tools After Milling by Different Work Materials CRRS $\phi 6 \times CR0.5$

Spindle Speed	Feed Rate	a_p Axial Depth	a_e Radial Depth	Overhang Length	Cycle Time	Coolant
10,000 min ⁻¹	12,000 mm/min	0.14 mm	2.4 mm	24 mm	90 min	Air Blow (Nozzle)

S50C

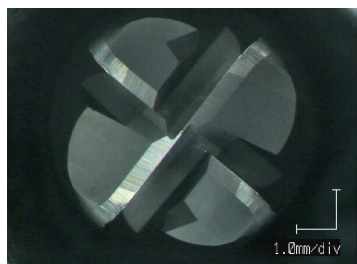

Relief Wear Width
0.070 mm

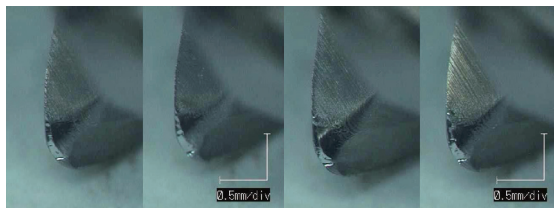

Spindle Speed	Feed Rate	a_p Axial Depth	a_e Radial Depth	Overhang Length	Cycle Time	Coolant
10,000 min ⁻¹	7,200 mm/min	0.07 mm	1.98 mm	24 mm	84 min	Water Soluble

SUS304

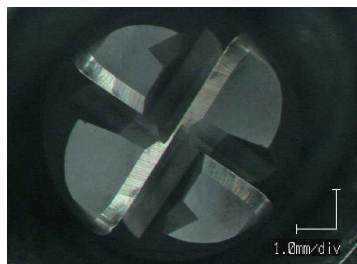

Relief Wear Width
0.032 mm

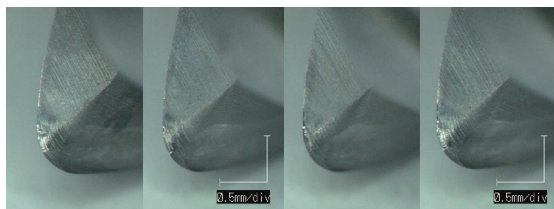

Spindle Speed	Feed Rate	a_p Axial Depth	a_e Radial Depth	Overhang Length	Cycle Time	Coolant
8,000 min ⁻¹	5,250 mm/min	0.07 mm	1.75 mm	24 mm	56 min	Oil Mist

STAVAX (52HRC)

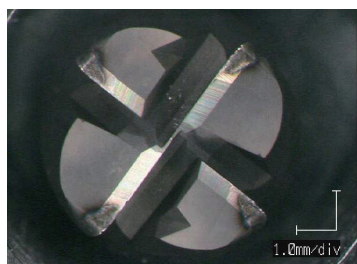

Relief Wear Width
0.087 mm

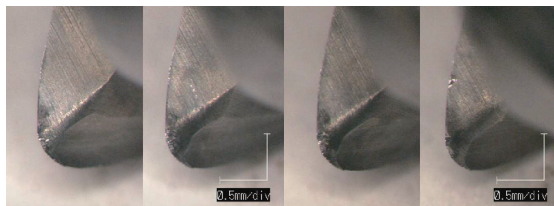

UDC Series

CBN Series

Square

Long Neck Square

Radius

Long Neck Radius

Taper Neck Radius

Ball / Long Shank Ball

Long Neck Ball

Taper Neck Ball

Taper

Spiral V Cutter

Drill

EURO Series

Technical Data



UDC Series

CBN Series

Square
Long Neck Square

Radius
Long Neck Radius
Taper Neck Radius

Ball / Long Shank Ball
Long Neck Ball
Taper Neck Ball

Taper
Taper

Spiral V Cutter

Drill

EURO Series

Technical Data



Size $\phi 1 \sim \phi 6$

DCLRS



Material Applications (☆ Highly Recommended ● Recommended ○ Suggested)

Work Material															
Carbon Steels S45C S55C	Alloy Steels SK / SCM SUS	Prehardened Steels NAK HPM	Hardened Steels			Cast Iron	Aluminum Alloys	Graphite	Copper	Plastics	Glass Filled Plastics	Titanium Alloys	Heat Resistant Alloys	Cemented Carbide	Hard Brittle (Non-Metallic) Materials
			~55HRC	~60HRC	~70HRC										
							○	☆	○	○	●				○

Features

Diamond coated 4 Flute Long Neck Radius End Mills for Graphite Electrodes.
Original diamond coating offers excellent resistance to wear on Graphite milling.
Long life tool with optimized flute geometry and high adhesion diamond coating.

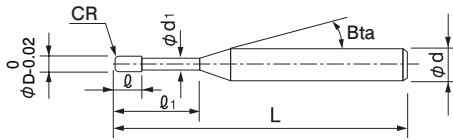

The shank taper angle shown is not an exact value and to avoid contact with the work piece, we recommend the user controls the precise value of this angle. Shank taper angle should not make contact with the work piece.

Total 39 models

Unit (mm)

Model Number	Outside Diameter ϕD	Corner Radius CR	Effective Length l_1	Length of Cut l	Neck Diameter ϕd_1	Shank Taper Angle Bta	Overall Length L	Shank Diameter ϕd	Price ¥
DCLRS 4010-002-060	1	RO.02	6	2	0.97	16°	50	4	16,000
DCLRS 4010-002-100			10				50	4	16,000
DCLRS 4010-002-200			20				60	4	16,000
DCLRS 4010-005-060		RO.05	6				50	4	16,000
DCLRS 4010-005-100			10				50	4	16,000
DCLRS 4010-005-200			20				60	4	16,000
DCLRS 4015-002-120	1.5	RO.02	12	3	1.47	16°	55	4	16,000
DCLRS 4015-002-200			20				60	4	16,000
DCLRS 4015-002-300			30				80	4	17,000
DCLRS 4015-005-120		RO.05	12				55	4	16,000
DCLRS 4015-005-200			20				60	4	16,000
DCLRS 4015-005-300			30				80	4	17,000

Unit (mm)

Model Number	Outside Diameter ϕD	Corner Radius CR	Effective Length ℓ_1	Length of Cut ℓ	Neck Diameter ϕd_1	Shank Taper Angle Bta	Overall Length L	Shank Diameter ϕd	Price ¥
DCLRS 4020-005-100	2	RO.05	10	4	1.98	16°	50	4	16,000
DCLRS 4020-005-200			20				60	4	16,000
DCLRS 4020-02-100			RO.2				10	50	4
DCLRS 4020-02-200		20					60	4	16,000
DCLRS 4020-02-300		30					80	4	17,000
DCLRS 4020-05-100		RO.5	10				50	4	16,000
DCLRS 4020-05-200			20				60	4	16,000
DCLRS 4020-05-300			30				80	4	17,000
DCLRS 4030-005-160		3	RO.05				16	6	2.95
DCLRS 4030-005-200	20			60	4	18,000			
DCLRS 4030-005-300	30			80	4	20,000			
DCLRS 4030-02-160	RO.2		16	60	4	18,000			
DCLRS 4030-02-200			20	60	4	18,000			
DCLRS 4030-02-300			30	80	4	20,000			
DCLRS 4030-05-160	RO.5		16	60	4	18,000			
DCLRS 4030-05-200			20	60	4	18,000			
DCLRS 4030-05-300			30	80	4	20,000			
DCLRS 4040-02-200	4	RO.2	20	8	3.93	16°	60	6	20,000
DCLRS 4040-02-300			30				80	6	20,000
DCLRS 4040-02-400			40				80	6	20,000
DCLRS 4040-05-200		RO.5	20				60	6	20,000
DCLRS 4040-05-300			30				80	6	20,000
DCLRS 4040-05-400			40				80	6	20,000
DCLRS 4060-02-300	6	RO.2	30	12	5.93	—	100	6	23,000
DCLRS 4060-02-600			60				120	6	30,000
DCLRS 4060-05-300		RO.5	30				100	6	23,000
DCLRS 4060-05-600			60				120	6	30,000

4 Flutes

UDC Series

CBN Series

Square
Long Neck Square

Radius

Radius
Long Neck Radius

Taper Neck Radius

Ball / Long Shank Ball

Ball
Long Neck Ball

Taper Neck Ball

Taper
Taper

Spiral V Cutter

Drill

EURO Series

Technical Data

Milling Conditions for DCLRS

WORK MATERIAL				GRAPHITE			
Model Number	Outside Diameter (mm)	Corner Radius (mm)	Effective Length (mm)	Spindle Speed (min ⁻¹)	Feed Rate (mm/min)	a_p Axial Depth (mm)	a_e Radial Depth (mm)
4010-002-060	1	R0.02	6	26,000	1,700	0.12	0.7
4010-002-100			10	22,000	1,300	0.12	0.6
4010-002-200			20	13,000	750	0.1	0.5
4010-005-060		R0.05	6	26,000	1,700	0.12	0.6
4010-005-100			10	22,000	1,300	0.12	0.5
4010-005-200			20	13,000	750	0.1	0.4
4015-002-120	1.5	R0.02	12	19,000	1,700	0.18	1.1
4015-002-200			20	15,000	1,300	0.14	0.9
4015-002-300			30	10,000	800	0.11	0.7
4015-005-120		R0.05	12	19,000	1,700	0.18	0.95
4015-005-200			20	15,000	1,300	0.14	0.75
4015-005-300			30	10,000	800	0.11	0.6
4020-005-100	2	R0.05	10	20,000	2,400	0.3	1.4
4020-005-200			20	16,000	1,800	0.25	1.35
4020-02-100		R0.2	10	20,000	2,400	0.3	1.2
4020-02-200			20	16,000	1,800	0.25	1.15
4020-02-300			30	12,000	1,300	0.2	1.1
4020-05-100			R0.5	10	20,000	2,400	0.3
4020-05-200	20	16,000		1,800	0.25	0.9	
4020-05-300	30	12,000		1,300	0.2	0.85	
4030-005-160	3	R0.05	16	16,500	3,100	0.4	2.3
4030-005-200			20	16,000	2,900	0.4	2.1
4030-005-300			30	14,000	2,300	0.4	1.9
4030-02-160		R0.2	16	16,500	3,100	0.4	2
4030-02-200			20	16,000	2,900	0.4	1.8
4030-02-300			30	14,000	2,300	0.4	1.6
4030-05-160	R0.5	16	16,500	3,100	0.4	1.7	
4030-05-200		20	16,000	2,900	0.4	1.5	
4030-05-300		30	14,000	2,300	0.4	1.4	
4040-02-200	4	R0.2	20	14,000	3,400	0.5	2.7
4040-02-300			30	13,000	3,000	0.5	2.6
4040-02-400			40	12,000	2,600	0.5	2.5
4040-05-200		R0.5	20	14,000	3,400	0.5	2.3
4040-05-300			30	13,000	3,000	0.5	2.2
4040-05-400			40	12,000	2,600	0.5	2.1
4060-02-300	6	R0.2	30	13,000	4,300	0.75	4
4060-02-600			60	10,000	2,800	0.75	3.7
4060-05-300		R0.5	30	13,000	4,300	0.75	3.5
4060-05-600			60	10,000	2,800	0.75	3.1

Note:

- Use a milling machine dedicated for Graphite.
- Recommend air blow for Graphite.

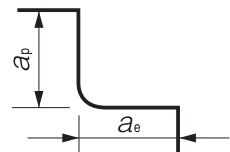

a_p : Axial Depth (mm)
 a_e : Radial Depth (mm)



UDC Series

CBN Series

Square
Long Neck Square

Radius
Long Neck Radius
Taper Neck Radius

Ball / Long Shank Ball
Long Neck Ball
Taper Neck Ball

Taper

Spiral V Cutter

Drill

EURO Series

Technical Data



Size $\phi 3 \sim \phi 12$

CXLRS



$\phi 3 \sim \phi 6$

$\phi 8 \sim \phi 12$

Material Applications (☆ Highly Recommended ○ Recommended ○ Suggested)

Work Material															
Carbon Steels S45C S55C	Alloy Steels SK / SCM SUS	Prehardened Steels NAK HPM	Hardened Steels			Cast Iron	Aluminum Alloys	Graphite	Copper	Plastics	Glass Filled Plastics	Titanium Alloys	Heat Resistant Alloys	Cemented Carbide	Hard Brittle (Non-Metallic) Materials
			~55HRC	~60HRC	~70HRC										
○	○	○	○			○	○		○			○	○		

Features

**Broad application range from Carbon Steels to Hardened Steels (55HRC).
Variable pitch, variable helix and positive rake angle design offers highly efficient side milling.
Seamless Corner Radius design reduces cutting resistance.**

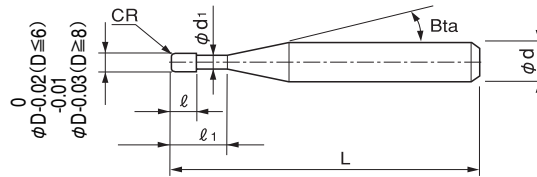

The shank taper angle shown is not an exact value and to avoid contact with the work piece, we recommend the user controls the precise value of this angle. Shank taper angle should not make contact with the work piece.

Variable Pitch

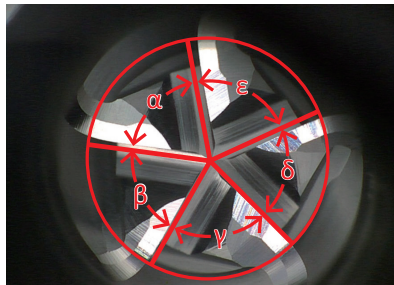

$$\alpha \neq \beta \neq \gamma \neq \delta \neq \epsilon$$

Seamless Corner Radius



Variable Helix

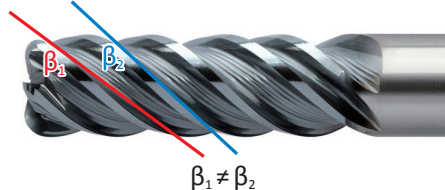

$$\beta_1 \neq \beta_2$$

- UDC Series
- CBN Series
- Square
- Long Neck Square
- Radius
- Long Neck Radius
- Taper Neck Radius
- Ball / Long Shank Ball
- Long Neck Ball
- Taper Neck Ball
- Taper
- Spiral V Cutter
- Drill
- EURO Series
- Technical Data

Total 30 models

Unit (mm)

Model Number	Outside Diameter ϕD	Corner Radius CR	Effective Length ℓ_1	Length of Cut ℓ	Neck Diameter ϕd_1	Shank Taper Angle B_{α}	Overall Length L	Shank Diameter ϕd	Price ¥
CXLR5 5030-05-09	3	R0.5	9	6	2.95	16°	50	6	10,800
CXLR5 5030-05-12			12				50		
CXLR5 5040-05-12	4	R0.5	12	8	3.85	16°	60	6	11,600
CXLR5 5040-05-16			16				60		
CXLR5 5040-10-12		R1	12				60		
CXLR5 5040-10-16			16				60		
CXLR5 5060-05-18	6	R0.5	18	12	5.85	—	70	6	13,400
CXLR5 5060-05-24			24				70		
CXLR5 5060-10-18		R1	18				70		
CXLR5 5060-10-24			24				70		
CXLR5 5080-05-24	8	R0.5	24	16	7.8	—	70	8	16,700
CXLR5 5080-05-32			32				70		
CXLR5 5080-10-24		R1	24				70		
CXLR5 5080-10-32			32				70		
CXLR5 5100-05-30	10	R0.5	30	20	9.8	—	80	10	22,000
CXLR5 5100-05-40			40				80		
CXLR5 5100-10-30		R1	30				80		
CXLR5 5100-10-40			40				80		
CXLR5 5100-15-30		R1.5	30				80		
CXLR5 5100-15-40			40				80		
CXLR5 5100-20-30		R2	30				80		
CXLR5 5100-20-40			40				80		
CXLR5 5120-05-36	12	R0.5	36	24	11.8	—	80	12	27,700
CXLR5 5120-05-48			48				100		
CXLR5 5120-10-36		R1	36				80		
CXLR5 5120-10-48			48				100		
CXLR5 5120-15-36		R1.5	36				80		
CXLR5 5120-15-48			48				100		
CXLR5 5120-20-36		R2	36				80		
CXLR5 5120-20-48			48				100		

5 Flutes

UDC Series

CBN Series

Square
Long Neck Square

Radius

Radius
Long Neck Radius
Taper Neck Radius

Ball / Long Shank Ball
Long Neck Ball

Taper Neck Ball
Taper

Spiral V Cutter

Drill

EURO Series

Technical Data

Milling Conditions for CXLRS

WORK MATERIAL			CARBON STEELS S45C / S50C Annealed Materials (~225HB)				ALLOY STEELS SK / SCM Annealed Materials (225~325HB)				PREHARDENED STEELS HPM / NAK (30~45HRC)				HARDENED STEELS SKD / SKT / STAVAX (45~55HRC)			
Model Number	Outside Diameter (mm)	Effective Length (mm)	Spindle Speed (min ⁻¹)	Feed Rate (mm/min)	a _p Axial Depth (mm)	a _e Radial Depth (mm)	Spindle Speed (min ⁻¹)	Feed Rate (mm/min)	a _p Axial Depth (mm)	a _e Radial Depth (mm)	Spindle Speed (min ⁻¹)	Feed Rate (mm/min)	a _p Axial Depth (mm)	a _e Radial Depth (mm)	Spindle Speed (min ⁻¹)	Feed Rate (mm/min)	a _p Axial Depth (mm)	a _e Radial Depth (mm)
5030	3	9	20,000	6,000	6	0.24	20,000	6,000	6	0.24	20,000	6,400	6	0.09	20,000	12,000	6	0.05
		12	20,000	6,000	6	0.19	20,000	6,000	6	0.19	20,000	6,400	6	0.07	20,000	12,000	6	0.04
5040	4	12	18,200	5,460	8	0.32	18,200	5,460	8	0.32	15,900	4,770	8	0.12	15,000	11,500	8	0.05
		16	18,200	5,460	8	0.26	18,200	5,460	8	0.26	15,900	4,770	8	0.1	15,000	11,500	8	0.04
5060	6	18	12,200	5,100	12	0.48	12,200	5,100	12	0.48	12,000	5,000	12	0.18	10,000	7,600	12	0.1
		24	12,200	5,100	12	0.38	12,200	5,100	12	0.38	12,000	5,000	12	0.14	10,000	7,600	12	0.08
5080	8	24	9,100	4,550	16	0.64	9,100	4,550	16	0.64	9,000	4,500	16	0.32	7,600	5,600	16	0.15
		32	9,100	4,550	16	0.51	9,100	4,550	16	0.51	9,000	4,500	16	0.26	7,600	5,600	16	0.12
5100	10	30	7,300	3,650	20	0.8	7,300	3,650	20	0.8	7,300	3,650	20	0.4	6,000	4,500	20	0.22
		40	7,300	3,650	20	0.64	7,300	3,650	20	0.64	7,300	3,650	20	0.32	6,000	4,500	20	0.176
5120	12	36	6,100	3,050	24	0.96	6,100	3,050	24	0.96	6,100	3,050	24	0.48	5,000	3,800	24	0.25
		48	6,100	3,050	24	0.77	6,100	3,050	24	0.77	6,100	3,050	24	0.38	5,000	3,800	24	0.2

Note:

- Please be sure to use water soluble coolant.
- These milling parameters are for reference only. For best result, fine parameter adjustments may be required, depending on the milling shape / application / machine and so on.
- Decrease both spindle speed and feed rate proportionally when the milling parameters exceed the machine's maximum spindle speed.
- **WARNING:** Because of high material removal rate, you must pay attention to your chip and coolant management.

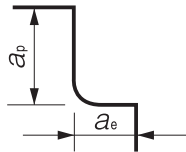

Side Milling

a_p : Axial Depth (mm)

a_e : Radial Depth (mm)

Milling Example : CXLRS $\phi 6 \times CR0.5 \times$ Effective Length 24 Roughing RAMAX (32HRC)



Size : 500 x 500 mm
Coolant : Air Blow
Milling Method : Vortex (Trochoid)

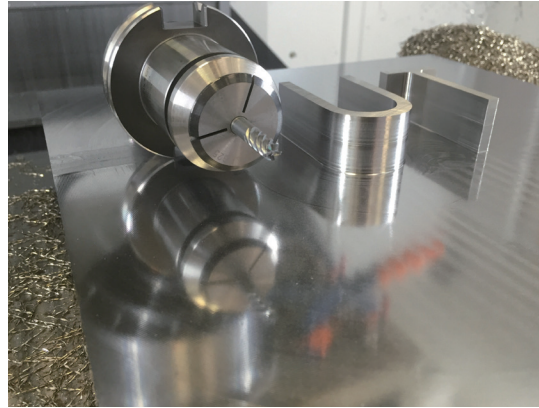

Spindle Speed : 14,000 min⁻¹
Feed Rate : 7,000 mm/min
Axial Depth a_p : 12 mm
Radial Depth a_e : 0.5 mm

CXLRS
Roughing Video



5 Flutes

UDC
Series

CBN
Series

Square
Long Neck
Square

Radius

Long Neck
Radius

Taper Neck
Radius

Ball / Long
Shank Ball

Ball

Taper Neck
Ball

Taper

Spiral
V Cutter

Drill

EURO Series

Technical Data



Size $\phi 6 \sim \phi 12$

HHRS



$\phi 6$ $\phi 8 \sim \phi 12$

Material Applications (☆ Highly Recommended ● Recommended ○ Suggested)

Work Material															
Carbon Steels S45C S55C	Alloy Steels SK / SCM SUS	Prehardened Steels NAK HPM	Hardened Steels			Cast Iron	Aluminum Alloys	Graphite	Copper	Plastics	Glass Filled Plastics	Titanium Alloys	Heat Resistant Alloys	Cemented Carbide	Hard Brittle (Non-Metallic) Materials
			~55HRC	~60HRC	~70HRC										
○	○	●	●	○		○						○	○		

Features

**Long Neck Radius design for milling on Hard Materials.
High rigid 6 Flute Radius End Mills.**

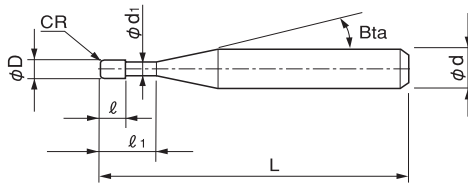
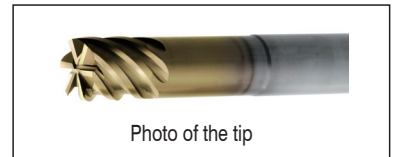

The shank taper angle shown is not an exact value and to avoid contact with the work piece, we recommend the user controls the precise value of this angle. Shank taper angle should not make contact with the work piece.

Total 14 models

Unit (mm)

Model Number	Outside Diameter ϕD	Corner Radius CR	Effective Length ℓ_1	Length of Cut ℓ	Neck Diameter ϕd_1	Shank Taper Angle Bta	Overall Length L	Shank Diameter ϕd	Price ¥
HHRS 6060-01-210	6	RO.1	21	6	5.95	—	60	6	16,800
HHRS 6060-02-210		RO.2					60	6	16,800
HHRS 6060-03-210		RO.3					60	6	16,800
HHRS 6060-05-210		RO.5					60	6	16,800
HHRS 6060-10-210		R1					60	6	16,800
HHRS 6080-03-260	8	RO.3	26	8	7.81	—	80	8	21,780
HHRS 6080-05-260		RO.5					80	8	21,780
HHRS 6080-10-260		R1					80	8	21,780
HHRS 6100-03-310	10	RO.3	31	10	9.81	—	80	10	22,990
HHRS 6100-05-310		RO.5					80	10	22,990
HHRS 6100-10-310		R1					80	10	22,990
HHRS 6120-03-370	12	RO.3	37	12	11.81	—	100	12	32,670
HHRS 6120-05-370		RO.5					100	12	32,670
HHRS 6120-10-370		R1					100	12	32,670

Milling Conditions for HHRS

Side Milling

WORK MATERIAL		CARBON STEELS S45C / S50C		ALLOY STEELS SK / SCM / SUS		PREHARDENED STEELS HARDENED STEELS (30~45HRC)		HARDENED STEELS (45~55HRC)		HARDENED STEELS (55~65HRC)	
Model Number	Outside Diameter (mm)	Spindle Speed (min ⁻¹)	Feed Rate (mm/min)	Spindle Speed (min ⁻¹)	Feed Rate (mm/min)	Spindle Speed (min ⁻¹)	Feed Rate (mm/min)	Spindle Speed (min ⁻¹)	Feed Rate (mm/min)	Spindle Speed (min ⁻¹)	Feed Rate (mm/min)
6060	6	6,300	2,650	6,300	2,650	6,300	2,650	4,800	2,000	3,200	1,600
6080	8	4,750	2,650	4,750	2,650	4,750	2,650	3,600	2,000	2,400	1,600
6100	10	3,800	2,650	3,800	2,650	3,800	2,650	2,850	2,000	2,000	1,600
6120	12	3,150	2,650	3,150	2,650	3,150	2,650	2,400	2,000	1,600	1,600
Milling Amount (mm)		$a_p: 1D$ $a_e: 0.04D$		$a_p: 1D$ $a_e: 0.04D$		$a_p: 1D$ $a_e: 0.04D$		$a_p: 0.8D$ $a_e: 0.02D$		$a_p: 0.5D$ $a_e: 0.01D$	

Bottom Surface Milling

WORK MATERIAL		CARBON STEELS S45C / S50C		ALLOY STEELS SK / SCM / SUS		PREHARDENED STEELS HARDENED STEELS (30~45HRC)		HARDENED STEELS (45~55HRC)		HARDENED STEELS (55~65HRC)	
Model Number	Outside Diameter (mm)	Spindle Speed (min ⁻¹)	Feed Rate (mm/min)	Spindle Speed (min ⁻¹)	Feed Rate (mm/min)	Spindle Speed (min ⁻¹)	Feed Rate (mm/min)	Spindle Speed (min ⁻¹)	Feed Rate (mm/min)	Spindle Speed (min ⁻¹)	Feed Rate (mm/min)
6060	6	6,300	2,650	6,300	2,650	6,300	2,650	4,800	2,000	3,200	1,600
6080	8	4,750	2,650	4,750	2,650	4,750	2,650	3,600	2,000	2,400	1,600
6100	10	3,800	2,650	3,800	2,650	3,800	2,650	2,850	2,000	2,000	1,600
6120	12	3,150	2,650	3,150	2,650	3,150	2,650	2,400	2,000	1,600	1,600
Milling Amount (mm)		$a_p: 0.02D$ $a_e: 0.2D$		$a_p: 0.02D$ $a_e: 0.2D$		$a_p: 0.02D$ $a_e: 0.2D$		$a_p: 0.015D$ $a_e: 0.2D$		$a_p: 0.01D$ $a_e: 0.2D$	

Note:

- Decrease both spindle speed and feed rate proportionally when the milling parameters exceed the machine's maximum speed, or when the tool is chattering and heats up to a red color.
- When milling on a side or bottom surface, set the a_p amount taking into consideration the remaining corner area.
- Recommend wet coolant for Stainless Steels.

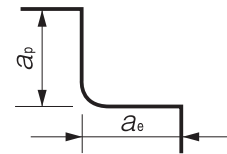

a_p : Axial Depth (mm)
 a_e : Radial Depth (mm)
 D : Outside Diameter (mm)

Bottom Surface Milling Comparison between HHRS & 4 Flute Square End Mills NAK80 (40HRC)

Better bottom surface roughness compared to 4 flute square type.

Spindle Speed	Feed Rate	Axial Depth a_p	Radial Depth a_e	Overhang Length	Coolant
6,300 min ⁻¹	2,650 mm/min	0.12 mm	1.2 mm	22 mm	Air blow (Nozzle)

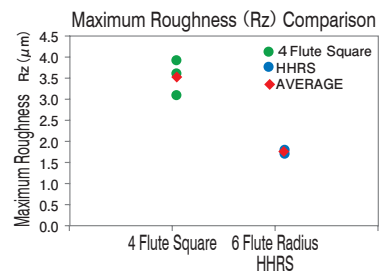
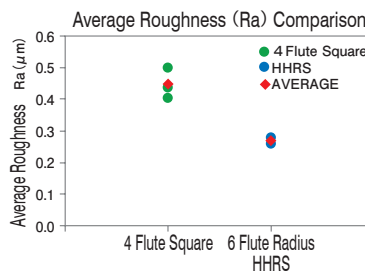
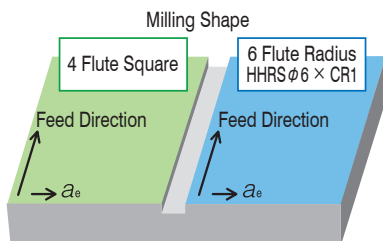

- 6 Flutes
- UDC Series
- CBN Series
- Square
- Long Neck Square
- Radius
- Long Neck Radius
- Taper Neck Radius
- Ball / Long Shank Ball
- Long Neck Ball
- Taper Neck Ball
- Taper
- Spiral V Cutter
- Drill
- EURO Series
- Technical Data



Size $\phi 1 \sim \phi 6$

HTNRS



Additional 28 models

Material Applications (☆ Highly Recommended ○ Recommended ○ Suggested)

Work Material															
Carbon Steels	Alloy Steels	Prehardened Steels	Hardened Steels			Cast Iron	Aluminum Alloys	Graphite	Copper	Plastics	Glass Filled Plastics	Titanium Alloys	Heat Resistant Alloys	Cemented Carbide	Hard Brittle (Non-Metallic) Materials
S45C S55C	SK / SCM SUS	NAK HPM	~55HRC	~60HRC	~70HRC										
		○	○	○	○	○									

The shank taper angle shown is not an exact value and to avoid contact with the work piece, we recommend the user controls the precise value of this angle. Shank taper angle should not make contact with the work piece.

Shape A

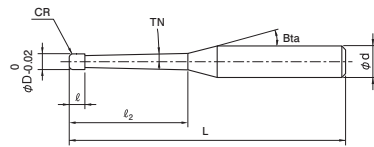

Shape B

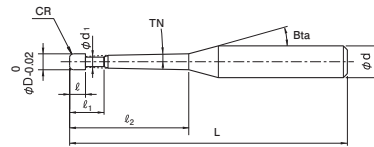

Shape C

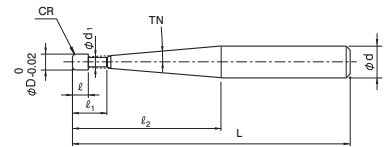

Total 111 models

Unit (mm)

Model Number	Outside Diameter ϕD	Corner Radius CR	Neck Taper Angle TN	Neck Length ℓ_2	Effective Length ℓ_1	Length of Cut ℓ	Neck Diameter ϕd_1	Shank Taper Angle Bta	Overall Length L	Shank Diameter ϕd		
HTNRS 4010-020608	1	R0.2	0.4°	6	—	1	—	16°	50	4		
HTNRS 4010-021008				10					50	4		
HTNRS 4010-022008				20					60	4		
HTNRS 4010-023008				30					70	4		
HTNRS 4010-020618				6					50	4		
HTNRS 4010-021018				10					50	4		
HTNRS 4010-021518			15	50	4							
HTNRS 4010-022018			20	60	4							
HTNRS 4010-022518			25	60	4							
HTNRS 4010-023018			30	70	4							
HTNRS 4010-023518			35	80	4							
HTNRS 4010-024018			40	80	4							
HTNRS 4010-025018			50	90	4							
※ HTNRS 4010-020628			1.4°	—	—	6	1.8	—	0.94	—	50	4
※ HTNRS 4010-021028						10					50	4
※ HTNRS 4010-022028						20					60	4
※ HTNRS 4010-023028	30	70				4						

※Additional model

Features

4 Flute Taper Neck Radius End Mills for milling hard materials.
 Corner radius design from the edge to the periphery ensures less cutting resistance,
 and the variable pitch design minimizes chattering and vibration.
 Can achieve stable milling and excellent surface finish on deep milling.
 HARDMAX coating offers longer tool life when milling hard materials. Recommended to
 use with any type of coolant.

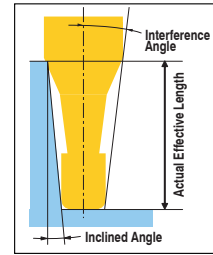

Feature ①

Seamless Corner Radius
 High rigidity! Less cutting resistance!

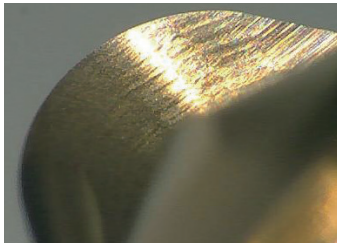

Feature ②

Variable Pitch design
 Minimizing vibration and chattering !

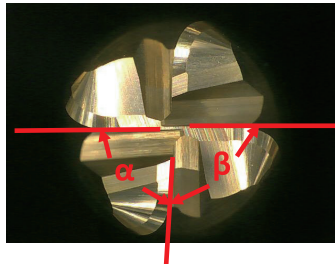

※ Variable Pitch : $\alpha \neq \beta$

Feature ③

A wide choice of Taper Neck Angles available
 More efficient with 1.4° · 1.9° · 2.9° !



Unit (mm)

Model Number	Outside Diameter ϕD	Corner Radius CR	Neck Taper Angle TN	Neck Length ℓ_2	Shape	Price ¥	Interference Angle	Effective Length by Inclined Angles — : Interference				
								30'	1°	1°30'	2°	3°
HTNRS 4010-020608	1	R0.2	0.4°	6	A	10,000	7.37°	6.56	6.92	7.20	7.45	8.00
HTNRS 4010-021008				10		10,000	5.54°	10.61	11.12	11.50	11.89	12.77
HTNRS 4010-022008				20		10,000	3.42°	20.73	21.52	22.24	23.00	24.71
HTNRS 4010-023008				30		12,000	2.47°	30.83	31.91	32.97	34.11	No Interference
HTNRS 4010-020618				6		10,000	7.49°	—	6.61	6.96	7.23	7.76
HTNRS 4010-021018				10		10,000	5.65°	—	10.66	11.15	11.53	12.38
HTNRS 4010-021518			15	10,000		4.33°	—	15.72	16.35	16.92	18.17	
HTNRS 4010-022018			20	10,000		3.50°	—	20.77	21.56	22.30	23.95	
HTNRS 4010-022518			25	10,000		2.94°	—	25.82	26.76	27.68	No Interference	
HTNRS 4010-023018			30	12,000		2.54°	—	30.87	31.96	33.06	No Interference	
HTNRS 4010-023518			35	14,000		2.23°	—	35.92	37.16	38.44	No Interference	
HTNRS 4010-024018			40	14,000		1.99°	—	40.96	42.36	No Interference	No Interference	
HTNRS 4010-025018			50	15,000		1.64°	—	51.02	52.74	No Interference	No Interference	
HTNRS 4010-020628			6	10,000		7.61°	—	—	6.66	7.00	7.53	
HTNRS 4010-021028			10	10,000		5.77°	—	—	10.71	11.18	12.00	
HTNRS 4010-022028			20	10,000		3.59°	—	—	20.81	21.59	23.20	
HTNRS 4010-023028			30	12,000		2.61°	—	—	30.91	32.01	No Interference	

Next Page ➡

4 Flutes

UDC Series

CBN Series

Square

Long Neck Square

Radius

Long Neck Radius

Taper Neck Radius

Ball / Long Shank Ball

Long Neck Ball

Taper Neck Ball

Taper

Spiral V Cutter

Drill

EURO Series

Technical Data

Unit (mm)

Model Number	Outside Diameter ϕD	Corner Radius CR	Neck Taper Angle TN	Neck Length ℓ_2	Effective Length ℓ_1	Length of Cut ℓ	Neck Diameter ϕd_1	Shank Taper Angle Bta	Overall Length L	Shank Diameter ϕd								
HTNRS 40125-020618	1.25	R0.2	0.9°	6	—	1.25	—	16°	50	4								
HTNRS 40125-021018				10					50	4								
HTNRS 40125-021518				15					50	4								
HTNRS 40125-022018				20					60	4								
HTNRS 40125-023018				30					70	4								
HTNRS 40125-024018				40					80	4								
HTNRS 40125-025018				50					90	4								
HTNRS 4015-030608	1.5	R0.3	0.4°	6	—	1.5	—	16°	50	4								
HTNRS 4015-031008				10					50	4								
HTNRS 4015-032008				20					60	4								
HTNRS 4015-033008				30					70	4								
HTNRS 4015-030618			0.9°	6					—	1.5	—	16°	50	4				
HTNRS 4015-031018				10									50	4				
HTNRS 4015-031518				15									50	4				
HTNRS 4015-032018				20									60	4				
HTNRS 4015-032518				25									60	4				
HTNRS 4015-033018				30									70	4				
HTNRS 4015-034018			40	80					4									
HTNRS 4015-035018			50	90					4									
※ HTNRS 4015-030628			1.4°	6					2.7	1.43	—	16°	50	4				
※ HTNRS 4015-031028				10									50	4				
※ HTNRS 4015-032028	20	60		4														
※ HTNRS 4015-033028	30	70		4														
HTNRS 40175-030618	1.75	R0.3	0.9°	6	—	1.75	—	16°	50	4								
HTNRS 40175-031018				10					50	4								
HTNRS 40175-031518				15					60	4								
HTNRS 40175-032018				20					60	4								
HTNRS 40175-033018				30					70	4								
HTNRS 40175-034018				40					80	4								
HTNRS 40175-035018				50					90	4								
HTNRS 4020-052008	2	R0.5	0.4°	20	—	2	—	16°	60	4								
HTNRS 4020-052608				26					60	4								
HTNRS 4020-053008				30					70	4								
HTNRS 4020-053608				36					80	4								
HTNRS 4020-054008				40					80	4								
HTNRS 4020-051018				10					60	4								
HTNRS 4020-051518			15	60					4									
HTNRS 4020-052018			20	60					4									
HTNRS 4020-052518			25	60					4									
HTNRS 4020-053018			30	70					4									
HTNRS 4020-053518			35	80					4									
HTNRS 4020-054018			40	80					4									
HTNRS 4020-054518			45	90					4									
HTNRS 4020-055018			50	90					4									
※ HTNRS 4020-053028			1.4°	30					3.6	1.9	—	16°	70	4				
※ HTNRS 4020-054028				40									80	4				
※ HTNRS 4020-053038				1.9°									30	3.6	1.9	—	70	6
※ HTNRS 4020-054038													40				80	6
※ HTNRS 4020-053058			2.9°	30					3.6	1.9	—	70	6					
※ HTNRS 4020-054258				42								90	6					

UDC Series

CBN Series

Square
Long Neck Square

Radius
Long Neck Radius
Taper Neck Radius

Ball / Long Shank Ball
Long Neck Ball

Taper

Spiral V Cutter

Drill

EURO Series

Technical Data

※Additional model

Model Number	Outside Diameter ϕD	Corner Radius CR	Neck Taper Angle TN	Neck Length ℓ_2	Shape	Price ¥	Interference Angle	Effective Length by Inclined Angles — Interference				
								30'	1°	1°30'	2°	3°
HTNRS 40125-020618	1.25	R0.2	0.9°	6	A	10,000	7.14°	—	6.63	6.97	7.24	7.77
HTNRS 40125-021018				10		10,000	5.34°	—	10.68	11.16	11.55	12.40
HTNRS 40125-021518				15		10,000	4.05°	—	15.74	16.37	16.93	18.18
HTNRS 40125-022018				20		10,000	3.27°	—	20.79	21.57	22.31	23.96
HTNRS 40125-023018				30		12,000	2.36°	—	30.89	31.97	33.07	No Interference
HTNRS 40125-024018				40		14,000	1.84°	—	40.97	42.37	No Interference	No Interference
HTNRS 40125-025018				50		15,000	1.51°	—	51.03	52.75	No Interference	No Interference
HTNRS 4015-030608	1.5	R0.3	0.4°	6	A	10,000	6.69°	6.62	6.96	7.23	7.47	8.01
HTNRS 4015-031008				10		10,000	4.92°	10.66	11.15	11.52	11.91	12.79
HTNRS 4015-032008				20		10,000	2.96°	20.78	21.55	22.26	23.03	No Interference
HTNRS 4015-033008				30		12,000	2.12°	30.87	31.94	33.00	34.13	No Interference
HTNRS 4015-030618			0.9°	6		10,000	6.80°	—	6.69	7.01	7.27	7.79
HTNRS 4015-031018				10		10,000	5.03°	—	10.73	11.19	11.57	12.42
HTNRS 4015-031518				15		10,000	3.79°	—	15.79	16.39	16.95	18.20
HTNRS 4015-032018				20		10,000	3.04°	—	20.84	21.60	22.34	23.99
HTNRS 4015-032518				25		10,000	2.54°	—	25.88	26.80	27.72	No Interference
HTNRS 4015-033018				30		12,000	2.18°	—	30.93	32.00	33.10	No Interference
HTNRS 4015-034018				40		14,000	1.70°	—	41.01	42.40	No Interference	No Interference
HTNRS 4015-035018			50	15,000		1.39°	—	51.07	No Interference	No Interference	No Interference	
HTNRS 4015-030628			1.4°	6		10,000	6.92°	—	—	6.76	7.06	7.58
HTNRS 4015-031028				10		10,000	5.13°	—	—	10.80	11.23	12.05
HTNRS 4015-032028				20		10,000	3.12°	—	—	20.89	21.65	23.25
HTNRS 4015-033028	30	12,000		2.24°	—	—	30.98	32.07	No Interference			
HTNRS 40175-030618	1.75	R0.3	0.9°	6	A	10,000	6.37°	—	6.75	7.06	7.31	7.84
HTNRS 40175-031018				10		10,000	4.66°	—	10.79	11.23	11.61	12.46
HTNRS 40175-031518				15		10,000	3.49°	—	15.84	16.43	16.99	18.24
HTNRS 40175-032018				20		10,000	2.78°	—	20.89	21.63	22.38	No Interference
HTNRS 40175-033018				30		12,000	1.99°	—	30.98	32.04	No Interference	No Interference
HTNRS 40175-034018				40		14,000	1.54°	—	41.06	42.44	No Interference	No Interference
HTNRS 40175-035018				50		15,000	1.26°	—	51.11	No Interference	No Interference	No Interference
HTNRS 4020-052008	2	R0.5	0.4°	20	A	11,000	2.48°	20.86	21.60	22.30	23.06	No Interference
HTNRS 4020-052608				26		11,000	1.98°	26.92	27.83	28.75	No Interference	No Interference
HTNRS 4020-053008				30		11,000	1.75°	30.95	31.98	33.04	No Interference	No Interference
HTNRS 4020-053608				36		14,000	1.49°	37.00	38.22	No Interference	No Interference	No Interference
HTNRS 4020-054008			40	14,000		1.35°	41.03	42.37	No Interference	No Interference	No Interference	
HTNRS 4020-051018			0.9°	10		11,000	4.33°	—	10.84	11.25	11.63	12.46
HTNRS 4020-051518				15		11,000	3.21°	—	15.88	16.45	17.01	18.25
HTNRS 4020-052018				20		11,000	2.54°	—	20.93	21.66	22.39	No Interference
HTNRS 4020-052518				25		11,000	2.11°	—	25.97	26.86	27.77	No Interference
HTNRS 4020-053018				30		11,000	1.80°	—	31.01	32.06	No Interference	No Interference
HTNRS 4020-053518				35		14,000	1.57°	—	36.05	37.26	No Interference	No Interference
HTNRS 4020-054018				40		14,000	1.39°	—	41.09	No Interference	No Interference	No Interference
HTNRS 4020-054518			45	15,000		1.25°	—	46.10	No Interference	No Interference	No Interference	
HTNRS 4020-055018			50	15,000		1.14°	—	51.14	No Interference	No Interference	No Interference	
HTNRS 4020-053028			1.4°	30		11,000	1.85°	—	—	31.07	No Interference	No Interference
HTNRS 4020-054028				40		14,000	1.43°	—	—	No Interference	No Interference	No Interference
HTNRS 4020-053038				1.9°		30	12,000	3.39°	—	—	—	31.12
HTNRS 4020-054038			40			15,000	2.69°	—	—	—	41.19	No Interference
HTNRS 4020-053058			2.9°	30		12,000	3.58°	—	—	—	—	31.23
HTNRS 4020-054258				42		16,500	2.74°	—	—	—	—	No Interference

4 Flutes

UDC Series

CBN Series

Square

Long Neck Square

Radius

Long Neck Radius

Taper Neck Radius

Ball / Long Shank Ball

Long Neck Ball

Taper Neck Ball

Taper

Spiral V Cutter

Drill

EURO Series

Technical Data

Model Number	Outside Diameter ϕD	Corner Radius CR	Neck Taper Angle TN	Neck Length ℓ_2	Effective Length ℓ_1	Length of Cut ℓ	Neck Diameter ϕd_1	Shank Taper Angle Bta	Overall Length L	Shank Diameter ϕd														
HTNRS 4030-082008	3	R0.8	0.4°	20	—	3	—	16°	60	6														
HTNRS 4030-082608				26					60	6														
HTNRS 4030-083008				30					70	6														
HTNRS 4030-083608				36					80	6														
HTNRS 4030-084008				40					80	6														
HTNRS 4030-082018			3	R0.8					0.9°	20	—	3	16°	60	6									
HTNRS 4030-082518										25				60	6									
HTNRS 4030-083018										30				70	6									
HTNRS 4030-083518										35				80	6									
HTNRS 4030-084018										40				80	6									
HTNRS 4030-085018									3	R0.8				0.9°	50	—	3	16°	90	6				
HTNRS 4030-086018															60				100	6				
※ HTNRS 4030-083028															1.4°				30	4.5	2.89	—	70	6
※ HTNRS 4030-084028																			40				80	6
※ HTNRS 4030-083038	1.9°	30			70	6																		
※ HTNRS 4030-084038		40			80	6																		
※ HTNRS 4030-083358		2.9°			33	80	6																	
HTNRS 4040-102508	4	R1			0.4°	25	—	4						16°	60				6					
HTNRS 4040-103008						30									70				6					
HTNRS 4040-103508			35	80		6																		
HTNRS 4040-104008			40	80		6																		
HTNRS 4040-104508			45	90		6																		
HTNRS 4040-105008			50	90	6																			
HTNRS 4040-102018			4	R1	0.9°	20					—	4	16°		60				6					
HTNRS 4040-102518						25			60	6														
HTNRS 4040-103018						30			70	6														
HTNRS 4040-103518						35			80	6														
HTNRS 4040-104018						40			80	6														
HTNRS 4040-105018					50	90			6															
HTNRS 4040-106018					60	100			6															
※ HTNRS 4040-104928					1.4°	49			6	3.8					—	90	6							
※ HTNRS 4040-106028	60	100				8																		
※ HTNRS 4040-103038	1.9°	30				70	8																	
※ HTNRS 4040-106738		67				120	8																	
※ HTNRS 4040-104558		2.9°				45	90	8																
HTNRS 4060-152018	6	R1.5			0.9°	20	—	6						16°		60	8							
HTNRS 4060-153018						30										70	8							
HTNRS 4060-154018			40	80		8																		
HTNRS 4060-155018			50	90		8																		
HTNRS 4060-156018			60	100		8																		
※ HTNRS 4060-155128			1.4°	51	9	5.8					—	90	8											
※ HTNRS 4060-153938				39								80	8											
※ HTNRS 4060-156938				1.9°								69	110			10								
※ HTNRS 4060-154758												2.9°	47			90	10							

※Additional model

UDC Series

CBN Series

Square

Long Neck Square

Radius

Long Neck Radius

Taper Neck Radius

Ball / Long Shank Ball

Long Neck Ball

Taper Neck Ball

Taper

Spiral V Cutter

Drill

EURO Series

Technical Data

Unit (mm)

Model Number	Outside Diameter ϕD	Corner Radius CR	Neck Taper Angle TN	Neck Length ℓ_2	Shape	Price ¥	Interference Angle	Effective Length by Inclined Angles — : Interference							
								30'	1°	1°30'	2°	3°			
HTNRS 4030-082008	3	R0.8	0.4°	20	A	12,000	3.48°	20.88	21.60	22.30	23.05	24.72			
HTNRS 4030-082608				26		12,000	2.82°	26.94	27.84	28.74	29.72	No Interference			
HTNRS 4030-083008				30		12,000	2.51°	30.97	31.99	33.04	34.16	No Interference			
HTNRS 4030-083608				36		14,000	2.14°	37.02	38.22	39.48	40.82	No Interference			
HTNRS 4030-084008				40		14,000	1.96°	41.05	42.38	43.78	No Interference	No Interference			
HTNRS 4030-082018			20	12,000		3.56°	—	20.98	21.69	22.41	24.03				
HTNRS 4030-082518			25	12,000		2.99°	—	26.02	26.89	27.79	No Interference				
HTNRS 4030-083018			30	12,000		2.57°	—	31.06	32.09	33.18	No Interference				
HTNRS 4030-083518			35	14,000		2.25°	—	36.10	37.29	38.56	No Interference				
HTNRS 4030-084018			40	14,000		2.01°	—	41.13	42.49	43.94	No Interference				
HTNRS 4030-085018			50	15,000		1.65°	—	51.18	52.87	No Interference	No Interference				
HTNRS 4030-086018			60	16,000		1.40°	—	61.25	No Interference	No Interference	No Interference				
HTNRS 4030-083028			30	12,000		2.64°	—	—	31.14	32.19	No Interference				
HTNRS 4030-084028			40	14,000		2.06°	—	—	41.21	42.61	No Interference				
HTNRS 4030-083038			30	12,000		2.71°	—	—	—	31.21	No Interference				
HTNRS 4030-084038			40	14,000		2.12°	—	—	—	41.28	No Interference				
HTNRS 4030-083358			33	C		2.64°	—	—	—	—	No Interference				
HTNRS 4040-102508			4	R1		0.4°	25	A	12,000	2.12°	25.49	26.28	27.13	28.04	No Interference
HTNRS 4040-103008							30		12,000	1.80°	30.52	31.48	32.50	No Interference	No Interference
HTNRS 4040-103508							35		14,000	1.57°	35.55	36.67	37.87	No Interference	No Interference
HTNRS 4040-104008	40	14,000			1.39°		40.58		41.87	No Interference	No Interference	No Interference			
HTNRS 4040-104508	45	15,000			1.24°		45.61		47.06	No Interference	No Interference	No Interference			
HTNRS 4040-105008	50	15,000			1.13°		50.63		52.24	No Interference	No Interference	No Interference			
HTNRS 4040-102018	20	12,000			2.64°	—	20.57		21.23	21.93	No Interference				
HTNRS 4040-102518	25	12,000			2.18°	—	25.60		26.43	27.32	No Interference				
HTNRS 4040-103018	30	12,000			1.85°	—	30.64		31.63	No Interference	No Interference				
HTNRS 4040-103518	35	14,000			1.61°	—	35.67		36.83	No Interference	No Interference				
HTNRS 4040-104018	40	14,000			1.42°	—	40.70		No Interference	No Interference	No Interference				
HTNRS 4040-105018	50	15,000			1.16°	—	50.75		No Interference	No Interference	No Interference				
HTNRS 4040-106018	60	16,000			0.98°	—	No Interference		No Interference	No Interference	No Interference				
HTNRS 4040-104928	49	C			1.21°	—	—		No Interference	No Interference	No Interference				
HTNRS 4040-106028	60	B			1.88°	—	—		60.94	No Interference	No Interference				
HTNRS 4040-103038	30	B			3.46°	—	—		—	30.89	33.13				
HTNRS 4040-106738	67	C			1.75°	—	—		—	No Interference	No Interference				
HTNRS 4040-104558	45	C			2.62°	—	—		—	—	No Interference				
HTNRS 4060-152018	6	R1.5			0.9°	20	A		17,000	2.69°	—	20.63	21.28	21.97	No Interference
HTNRS 4060-153018						30			17,000	1.88°	—	30.70	31.68	No Interference	No Interference
HTNRS 4060-154018						40			17,000	1.44°	—	40.76	No Interference	No Interference	No Interference
HTNRS 4060-155018						50			17,000	1.17°	—	50.83	No Interference	No Interference	No Interference
HTNRS 4060-156018						60			18,000	0.98°	—	No Interference	No Interference	No Interference	No Interference
HTNRS 4060-155128					51	17,000			1.18°	—	—	No Interference	No Interference	No Interference	
HTNRS 4060-153938					39	C			1.55°	—	—	—	No Interference	No Interference	
HTNRS 4060-156938					69	C			1.71°	—	—	—	No Interference	No Interference	
HTNRS 4060-154758					47	C			2.53°	—	—	—	—	No Interference	

4 Flutes

UDC Series

CBN Series

Square

Long Neck Square

Radius

Long Neck Radius

Taper Neck Radius

Ball / Long Shank Ball

Long Neck Ball

Taper Neck Ball

Taper

Spiral V Cutter

Drill

EURO Series

Technical Data

Milling Conditions for HTNRS

WORK MATERIAL					PREHARDENED STEELS / HARDENED STEELS NAK / SKD (30~45HRC)				HARDENED STEELS SKD / SKT (45~55HRC)				HARDENED STEELS SKD / SKH (55~65HRC)				
Model Number	Outside Diameter (mm)	Corner Radius (mm)	Neck Taper Angle TN	Neck Length (mm)	Spindle Speed (min ⁻¹)	Feed Rate (mm/min)	a _p Axial Depth (mm)	a _e Radial Depth (mm)	Spindle Speed (min ⁻¹)	Feed Rate (mm/min)	a _p Axial Depth (mm)	a _e Radial Depth (mm)	Spindle Speed (min ⁻¹)	Feed Rate (mm/min)	a _p Axial Depth (mm)	a _e Radial Depth (mm)	
4010-020608	1	R0.2	0.4°	6	20,000	2,600	0.06	0.44	11,600	980	0.029	0.23	8,900	530	0.012	0.09	
4010-021008				10	19,000	2,450	0.03	0.42	11,000	920	0.015	0.21	8,500	480	0.008	0.07	
4010-022008				20	17,000	2,150	0.008	0.37	9,700	800	0.005	0.18	7,600	400	0.004	0.05	
4010-023008				30	12,000	1,500	0.003	0.26	7,200	570	0.002	0.12	6,000	310	0.002	0.04	
4010-020618			6	20,000	2,600	0.06	0.45	11,600	980	0.029	0.24	8,900	530	0.012	0.1		
4010-021018			10	19,000	2,450	0.03	0.43	11,000	920	0.015	0.22	8,500	480	0.008	0.075		
4010-021518			15	18,500	2,400	0.02	0.41	10,700	880	0.01	0.21	8,200	450	0.006	0.065		
4010-022018			20	18,000	2,300	0.01	0.4	10,400	850	0.006	0.2	8,000	430	0.005	0.05		
4010-022518			25	17,000	2,150	0.008	0.38	9,900	800	0.005	0.19	7,700	410	0.004	0.05		
4010-023018			30	16,000	2,000	0.007	0.35	9,400	750	0.004	0.18	7,400	390	0.004	0.05		
4010-023518			35	15,000	1,850	0.006	0.32	8,800	700	0.004	0.16	7,000	370	0.003	0.05		
4010-024018			40	14,000	1,750	0.005	0.3	8,300	660	0.003	0.15	6,700	350	0.003	0.05		
4010-025018			50	12,000	1,500	0.003	0.28	7,200	570	0.002	0.14	6,000	310	0.002	0.05		
4010-020628			1.4°	6	20,000	2,600	0.06	0.46	11,600	980	0.029	0.25	8,900	530	0.012	0.11	
4010-021028				10	20,000	2,600	0.04	0.45	11,400	960	0.02	0.24	8,750	510	0.01	0.08	
4010-022028				20	19,000	2,400	0.02	0.4	10,900	900	0.01	0.2	8,400	470	0.005	0.06	
4010-023028	30	18,000		2,300	0.01	0.4	10,400	850	0.006	0.2	8,000	430	0.005	0.05			
40125-020618	1.25	R0.2		0.9°	6	16,000	2,600	0.075	0.56	9,200	990	0.036	0.3	7,100	540	0.015	0.12
40125-021018					10	16,000	2,600	0.057	0.55	9,200	990	0.027	0.29	7,100	540	0.012	0.1
40125-021518					15	15,500	2,500	0.04	0.53	8,900	950	0.019	0.27	6,900	500	0.01	0.08
40125-022018					20	15,000	2,400	0.022	0.51	8,700	900	0.011	0.26	6,700	470	0.007	0.07
40125-023018			30		14,400	2,300	0.011	0.47	8,300	860	0.006	0.23	6,400	440	0.005	0.06	
40125-024018			40		12,800	2,000	0.008	0.42	7,500	750	0.004	0.21	5,900	390	0.004	0.06	
40125-025018	50	11,000	1,700	0.006	0.37	6,500	650	0.003	0.19	5,300	350	0.003	0.06				
4015-030608	1.5	R0.3	0.4°	6	13,500	2,600	0.09	0.67	7,800	990	0.043	0.36	6,000	540	0.018	0.15	
4015-031008				10	13,500	2,600	0.083	0.66	7,700	980	0.04	0.35	6,000	540	0.017	0.13	
4015-032008				20	12,500	2,400	0.028	0.61	7,000	880	0.015	0.31	5,500	460	0.009	0.09	
4015-033008				30	12,000	2,300	0.012	0.55	6,900	860	0.007	0.27	5,350	440	0.006	0.07	
4015-030618			0.9°	6	13,500	2,600	0.09	0.67	7,800	990	0.043	0.36	6,000	540	0.018	0.15	
4015-031018				10	13,500	2,600	0.083	0.67	7,800	990	0.04	0.36	6,000	540	0.017	0.14	
4015-031518				15	13,000	2,500	0.055	0.65	7,500	950	0.029	0.34	5,800	500	0.013	0.12	
4015-032018				20	12,500	2,400	0.035	0.63	7,200	900	0.018	0.32	5,600	470	0.01	0.1	
4015-032518			25	12,500	2,400	0.025	0.61	7,000	880	0.013	0.31	5,500	460	0.009	0.08		
4015-033018			30	12,000	2,300	0.015	0.6	6,900	860	0.008	0.3	5,350	440	0.007	0.07		
4015-034018			40	12,000	2,300	0.012	0.55	6,900	860	0.007	0.27	5,350	440	0.006	0.07		
4015-035018			50	10,500	2,000	0.009	0.5	6,100	740	0.005	0.25	4,850	380	0.005	0.07		
4015-030628			1.4°	6	13,500	2,600	0.09	0.67	7,800	990	0.043	0.36	6,000	540	0.018	0.15	
4015-031028				10	13,500	2,600	0.085	0.67	7,800	990	0.04	0.36	6,000	540	0.017	0.15	
4015-032028				20	13,000	2,500	0.05	0.63	7,300	920	0.02	0.33	5,600	480	0.011	0.11	
4015-033028				30	12,500	2,400	0.025	0.61	7,000	880	0.013	0.31	5,500	460	0.009	0.08	

Milling Conditions for HTNRS

WORK MATERIAL				PREHARDENED STEELS / HARDENED STEELS NAK / SKD (30~45HRC)				HARDENED STEELS SKD / SKT (45~55HRC)				HARDENED STEELS SKD / SKH (55~65HRC)							
Model Number	Outside Diameter (mm)	Corner Radius (mm)	Neck Taper Angle TN	Neck Length (mm)	Spindle Speed (min ⁻¹)	Feed Rate (mm/min)	a _p Axial Depth (mm)	a _e Radial Depth (mm)	Spindle Speed (min ⁻¹)	Feed Rate (mm/min)	a _p Axial Depth (mm)	a _e Radial Depth (mm)	Spindle Speed (min ⁻¹)	Feed Rate (mm/min)	a _p Axial Depth (mm)	a _e Radial Depth (mm)			
40175-030618	1.75	R0.3	0.9°	6	11,500	2,600	0.105	0.78	6,600	990	0.05	0.42	5,100	540	0.021	0.17			
40175-031018				10	11,500	2,600	0.105	0.78	6,600	990	0.05	0.42	5,100	540	0.021	0.17			
40175-031518				15	11,500	2,600	0.07	0.76	6,500	950	0.037	0.4	5,000	510	0.017	0.14			
40175-032018				20	11,000	2,450	0.047	0.74	6,400	920	0.024	0.38	4,900	480	0.013	0.12			
40175-033018				30	11,000	2,450	0.027	0.71	6,400	920	0.014	0.36	4,900	480	0.01	0.1			
40175-034018				40	10,000	2,200	0.016	0.67	5,800	820	0.009	0.33	4,450	420	0.008	0.08			
40175-035018				50	10,000	2,200	0.013	0.62	5,800	820	0.008	0.31	4,450	420	0.007	0.08			
4020-052008	2	R0.5	0.4°	20	9,500	2,450	0.06	0.85	5,500	920	0.025	0.43	4,250	480	0.015	0.13			
4020-052608				26	9,500	2,450	0.04	0.83	5,500	920	0.021	0.42	4,250	480	0.013	0.12			
4020-053008				30	9,000	2,300	0.03	0.79	5,400	880	0.016	0.41	4,100	450	0.012	0.11			
4020-053608				36	9,000	2,300	0.02	0.75	5,200	850	0.011	0.39	4,000	430	0.01	0.1			
4020-054008			40	9,000	2,300	0.02	0.7	5,200	850	0.01	0.38	4,000	430	0.009	0.1				
4020-051018			0.9°	10	10,000	2,600	0.12	0.9	5,800	990	0.057	0.49	4,450	540	0.024	0.2			
4020-051518				15	10,000	2,600	0.09	0.88	5,600	950	0.044	0.47	4,350	510	0.02	0.17			
4020-052018				20	9,500	2,450	0.06	0.86	5,500	920	0.03	0.45	4,250	480	0.016	0.15			
4020-052518				25	9,500	2,450	0.05	0.85	5,500	920	0.025	0.43	4,250	480	0.015	0.13			
4020-053018				30	9,500	2,450	0.04	0.83	5,500	920	0.021	0.42	4,250	480	0.013	0.12			
4020-053518				35	9,000	2,300	0.03	0.81	5,300	880	0.016	0.41	4,100	450	0.012	0.11			
4020-054018				40	9,000	2,300	0.02	0.8	5,200	850	0.012	0.4	4,000	430	0.01	0.1			
4020-054518				45	9,000	2,300	0.02	0.75	5,200	850	0.011	0.39	4,000	430	0.01	0.1			
4020-055018				50	9,000	2,300	0.017	0.75	5,200	850	0.01	0.38	4,000	430	0.009	0.1			
4020-053028				1.4°	30	9,500	2,450	0.05	0.85	5,500	920	0.025	0.43	4,250	480	0.015	0.13		
4020-054028					40	9,500	2,450	0.04	0.83	5,500	920	0.02	0.42	4,250	480	0.013	0.12		
4020-053038				1.9°	30	9,500	2,450	0.06	0.85	5,500	920	0.03	0.43	4,250	480	0.017	0.14		
4020-054038					40	9,500	2,450	0.05	0.85	5,500	920	0.025	0.43	4,250	480	0.015	0.13		
4020-053058				2.9°	30	9,500	2,450	0.07	0.85	5,500	920	0.035	0.45	4,250	480	0.017	0.16		
4020-054258					42	9,500	2,450	0.06	0.85	5,500	920	0.03	0.45	4,250	480	0.016	0.15		
4030-082008				3	R0.8	0.4°	20	6,500	2,500	0.12	1.06	3,900	960	0.05	0.58	3,200	550	0.029	0.25
4030-082608			26				6,300	2,400	0.08	1.04	3,800	940	0.038	0.56	3,100	520	0.025	0.22	
4030-083008			30				6,300	2,400	0.064	1.01	3,800	920	0.034	0.55	3,100	510	0.022	0.21	
4030-083608			36				6,300	2,400	0.05	1	3,800	920	0.028	0.52	3,100	510	0.02	0.19	
4030-084008			40				6,300	2,400	0.04	0.98	3,800	920	0.023	0.51	3,100	510	0.018	0.17	
4030-082018			0.9°				20	6,700	2,600	0.13	1.07	4,000	1,000	0.065	0.6	3,300	590	0.034	0.28
4030-082518							25	6,500	2,500	0.1	1.05	3,900	960	0.05	0.58	3,200	550	0.029	0.25
4030-083018							30	6,300	2,400	0.072	1.03	3,800	920	0.038	0.56	3,100	510	0.024	0.22
4030-083518	35	6,300				2,400	0.064	1.01	3,800	920	0.034	0.55	3,100	510	0.022	0.21			
4030-084018	40	6,300				2,400	0.056	1	3,800	920	0.03	0.54	3,100	510	0.021	0.2			
4030-085018	50	6,300				2,400	0.04	0.98	3,800	920	0.023	0.51	3,100	510	0.018	0.17			
4030-086018	60	6,000				2,300	0.024	0.96	3,600	870	0.015	0.49	2,900	470	0.015	0.15			
4030-083028	1.4°	30				6,500	2,500	0.09	1.03	3,900	960	0.045	0.57	3,200	550	0.03	0.24		
4030-084028		40	6,300			2,400	0.06	1.01	3,800	920	0.035	0.55	3,100	510	0.02	0.21			
4030-083038	1.9°	30	6,500			2,500	0.1	1.05	3,900	960	0.05	0.58	3,200	550	0.03	0.25			
4030-084038		40	6,300			2,400	0.07	1.03	3,800	920	0.04	0.56	3,100	510	0.025	0.22			
4030-083358	2.9°	33	6,700			2,500	0.12	1.07	3,900	1,000	0.06	0.6	3,200	590	0.03	0.28			

4 Flutes

UDC Series

CBN Series

Square

Long Neck Square

Radius

Long Neck Radius

Taper Neck Radius

Ball / Long Shank Ball

Long Neck Ball

Taper Neck Ball

Taper

Spiral V Cutter

Drill

EURO Series

Technical Data

WORK MATERIAL					PREHARDENED STEELS / HARDENED STEELS NAK / SKD (30~45HRC)				HARDENED STEELS SKD / SKT (45~55HRC)				HARDENED STEELS SKD / SKH (55~65HRC)							
Model Number	Outside Diameter (mm)	Corner Radius (mm)	Neck Taper Angle TN	Neck Length (mm)	Spindle Speed (min ⁻¹)	Feed Rate (mm/min)	a_p Axial Depth (mm)	a_e Radial Depth (mm)	Spindle Speed (min ⁻¹)	Feed Rate (mm/min)	a_p Axial Depth (mm)	a_e Radial Depth (mm)	Spindle Speed (min ⁻¹)	Feed Rate (mm/min)	a_p Axial Depth (mm)	a_e Radial Depth (mm)				
4040-102508	4	R1	0.4°	25	5,000	2,600	0.17	1.42	3,000	1,000	0.085	0.8	2,450	600	0.045	0.38				
4040-103008				30	5,000	2,600	0.13	1.39	2,900	960	0.065	0.77	2,400	540	0.038	0.34				
4040-103508				35	4,800	2,450	0.09	1.37	2,900	920	0.048	0.75	2,350	480	0.032	0.3				
4040-104008				40	4,800	2,450	0.08	1.35	2,900	920	0.043	0.74	2,350	480	0.03	0.28				
4040-104508				45	4,800	2,450	0.07	1.33	2,900	920	0.038	0.72	2,350	480	0.028	0.26				
4040-105008				50	4,800	2,450	0.06	1.32	2,900	920	0.034	0.7	2,350	480	0.026	0.25				
4040-102018			4	R1	0.9°	20	5,000	2,600	0.19	1.44	3,000	1,000	0.095	0.82	2,450	600	0.048	0.4		
4040-102518						25	5,000	2,600	0.17	1.42	3,000	1,000	0.085	0.8	2,450	600	0.045	0.38		
4040-103018						30	5,000	2,600	0.15	1.41	3,000	1,000	0.076	0.79	2,450	600	0.042	0.36		
4040-103518						35	4,800	2,450	0.12	1.39	2,900	960	0.062	0.77	2,400	540	0.037	0.33		
4040-104018						40	4,800	2,450	0.09	1.37	2,900	920	0.048	0.75	2,350	480	0.032	0.3		
4040-105018						50	4,800	2,450	0.08	1.35	2,900	920	0.043	0.72	2,350	480	0.029	0.27		
4040-106018					1.4°	60	4,800	2,450	0.06	1.32	2,900	920	0.034	0.7	2,350	480	0.026	0.25		
4040-104928						49	4,800	2,500	0.1	1.37	2,900	960	0.05	0.74	2,350	540	0.035	0.28		
4040-106028					60	4,800	2,500	0.08	1.35	2,900	960	0.04	0.72	2,350	540	0.03	0.27			
4040-103038					1.9°	30	5,000	2,600	0.15	1.42	3,000	1,000	0.08	0.8	2,450	600	0.045	0.38		
4040-106738						67	4,800	2,500	0.12	1.4	2,900	960	0.05	0.78	2,350	540	0.03	0.35		
4040-104558					2.9°	45	5,000	2,600	0.15	1.41	3,000	1,000	0.08	0.79	2,450	600	0.045	0.36		
4060-152018					6	R1.5	0.9°	20	3,350	2,600	0.28	2.16	2,000	1,000	0.14	1.24	1,650	600	0.072	0.6
4060-153018								30	3,350	2,600	0.28	2.16	2,000	1,000	0.14	1.24	1,650	600	0.072	0.6
4060-154018	40	3,350	2,600	0.26				2.14	2,000	1,000	0.131	1.21	1,650	600	0.068	0.57				
4060-155018	50	3,350	2,600	0.2				2.1	2,000	1,000	0.103	1.17	1,650	600	0.058	0.51				
4060-156018	60	3,150	2,400	0.14				2.06	1,900	920	0.075	1.12	1,550	510	0.048	0.45				
4060-155128	1.4°	51	3,350	2,600			0.2	2.1	2,000	1,000	0.1	1.17	1,650	600	0.058	0.51				
4060-153938		39	3,350	2,600			0.26	2.14	2,000	1,000	0.13	1.21	1,650	600	0.068	0.57				
4060-156938	1.9°	69	3,150	2,400			0.14	2.06	1,900	920	0.075	1.12	1,550	510	0.048	0.45				
4060-154758		47	3,350	2,600			0.26	2.14	2,000	1,000	0.13	1.21	1,650	600	0.068	0.57				

Side Milling

a_p : Axial Depth (mm)

a_e : Radial Depth (mm)

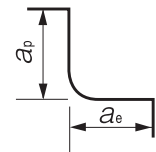

Note:

- Decrease both spindle speed and feed rate proportionally when the milling parameters exceed the machine's maximum spindle speed.
- Every coolant offers stable milling.

Milling Example of Taper Slotting
HTNRS $\phi 2 \times CR0.5 \times$ Neck Length 20 · 30 · 40

SKD61 (45HRC)

4 Flutes

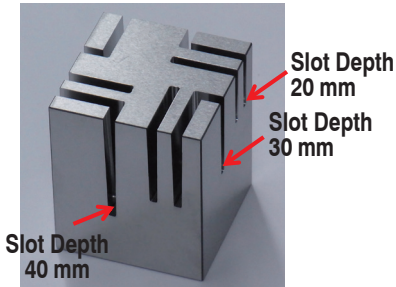

- Work Size : 50 × 50 × 60 mm
- Inclined Angle : 1°
- Slot Length : 27 mm (L Shape Slot)
21 mm (Straight Slot)
- Slot Width : 2.6 mm (Bottom)
- Slot Depth : 20, 30, 40 mm
- Coolant : Water Soluble

① Performance compared with straight neck type...Depth 20 mm L shape slotting

Milling Process	Tool	Neck Shape Helix Angle	Tool Size (mm)	Spindle Speed (min ⁻¹)	Feed Rate (mm/min)	a _p Axial Depth (mm)	Cycle Time
Roughing	HTNRS 4020-052018	Taper Neck 0.9° 45° Helix Angle	$\phi 2 \times CR0.5 \times$ Neck Length 20	9,500	2,450	0.064	20 min 18 sec
Roughing	HLRS 4020-05-200	Straight Neck 30° Helix Angle	$\phi 2 \times CR0.5 \times$ Effective Length 20	7,000	800	0.025	1 h 30 min 9 sec

Taper neck 7 times more efficient in 20 mm depth slotting !

② Depth 40 mm L shape slotting

Milling Process	Tool	Neck Shape Helix Angle	Tool Size (mm)	Spindle Speed (min ⁻¹)	Feed Rate (mm/min)	a _p Axial Depth (mm)	Cycle Time
Roughing	HTNRS 4020-052018	Taper Neck 0.9° 45° Helix Angle	$\phi 2 \times CR0.5 \times$ Neck Length 20 mm	9,500	2,450	0.064	27 min 8 sec
Roughing	HTNRS 4020-053018		$\phi 2 \times CR0.5 \times$ Neck Length 30 mm	9,500	2,450	0.047	15 min 32 sec
Roughing	HTNRS 4020-054018		$\phi 2 \times CR0.5 \times$ Neck Length 40 mm	9,000	2,300	0.02	40 min 26 sec
Finishing				4,500	500	0.0001 (Cusp Height)	4 h 28 min 50 sec

Slotting image of depth 40 mm

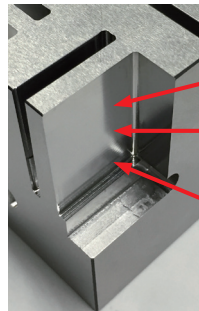
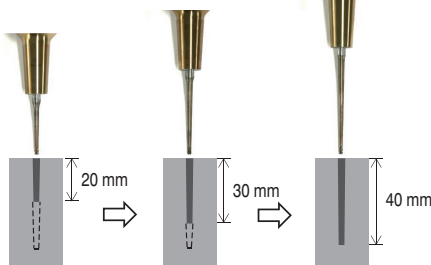

Depth 20 mm
Ra : 0.287 μm

Depth 30 mm
Ra : 0.241 μm

Depth 40 mm
Ra : 0.274 μm

40 mm slot depth roughing process completed in 1h 23 min ! Excellent surface finishing !

UDC Series

CBN Series

Square
Long Neck Square

Radius

Long Neck Radius
Taper Neck Radius

Ball / Long Shank Ball
Long Neck Ball
Taper Neck Ball

Taper

Spiral V Cutter

Drill

EURO Series

Technical Data



Size R0.05~R3

HGB

Super
MG

HM
G
COAT

30°

R
±0.002
R0.05~R0.075

R
±0.003
R0.1~R2

R
±0.005
R2.5~R3

Shank Dia
0/-0.004

Additional 2 models

Material Applications (☆ Highly Recommended ● Recommended ○ Suggested)

Work Material															
Carbon Steels S45C S55C	Alloy Steels SK / SCM SUS	Prehardened Steels NAK HPM	Hardened Steels			Cast Iron	Aluminum Alloys	Graphite	Copper	Plastics	Glass Filled Plastics	Titanium Alloys	Heat Resistant Alloys	Cemented Carbide	Hard Brittle (Non-Metallic) Materials
			~55HRC	~60HRC	~70HRC										
		○	●	●	●										

Features

Newly developed "HMCOAT", carbide grade and tool shape offer higher wear/chipping resistance as compared to conventional tools.

Achieves longer tool life and highly precise milling on hard materials.

High Precision Diameter Tolerance / Radius Accuracy / Shank Diameter Tolerance

Radius of Ball Nose	Diameter Tolerance	Ball Radius Accuracy	Shank Diameter Tolerance
R0.05 ~ R0.075	0/-0.008	±0.002	0/-0.004 (h4)
R0.1 ~ R1.25		±0.003	
R1.5 ~ R2	0/-0.01	±0.005	
R2.5 ~ R3			

Shank diameter tolerance h4!

The shank taper angle shown is not an exact value and to avoid contact with the workpiece, we recommend the user controls the precise value of this angle. Shank taper angle should not make contact with the work piece.

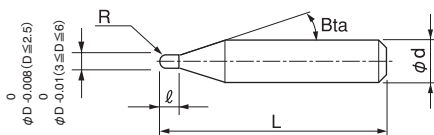

Total 20 models

Unit (mm)

Model Number	Radius of Ball Nose R	Length of Cut ℓ	Shank Taper Angle Bta	Overall Length L	Shank Diameter φd	Price ¥
※ HGB 2001-0010	R0.05	0.1	16°	50	4	12,960
※ HGB 20015-0015	R0.075	0.15	16°	50	4	12,600
HGB 2002-0030	R0.1	0.3	16°	50	4	9,120
HGB 2003-0030	R0.15	0.3	16°	50	4	7,440
HGB 2003-0045		0.45		50	4	7,440
HGB 2004-0040	R0.2	0.4	16°	50	4	5,040
HGB 2004-0060		0.6		50	4	5,040
HGB 2005-0050	R0.25	0.5	16°	50	4	4,680
HGB 2005-0075		0.75		50	4	4,680
HGB 2006-0060	R0.3	0.6	16°	50	4	4,560
HGB 2006-0090		0.9		50	4	4,560
HGB 2008-0120	R0.4	1.2	16°	50	4	4,560
HGB 2010-0150	R0.5	1.5	16°	50	4	4,150
HGB 2015-0225	R0.75	2.25	16°	50	4	5,040
HGB 2020-0300	R1	3	16°	50	4	3,720
HGB 2025-0375	R1.25	3.75	16°	50	4	6,370
HGB 2030-0450	R1.5	4.5	16°	50	6	4,560
HGB 2040-0600	R2	6	16°	50	6	5,160
HGB 2050-0750	R2.5	7.5	16°	50	6	6,240
HGB 2060-0900	R3	9	—	50	6	6,480

※Additional model

Milling Conditions for HGB

WORK MATERIAL			PREHARDENED STEELS HARDENED STEELS NAK / STAVAX (~55HRC)				HARDENED STEELS SKD11 (55~62HRC)				HARDENED STEELS HAP10 (62~66HRC)				HARDENED STEELS HAP72 (66~70HRC)			
Model Number	Radius of Ball Nose (mm)	Length of Cut (mm)	Spindle Speed (min ⁻¹)	Feed Rate (mm/min)	a_p Axial Depth (mm)	a_e Radial Depth (mm)	Spindle Speed (min ⁻¹)	Feed Rate (mm/min)	a_p Axial Depth (mm)	a_e Radial Depth (mm)	Spindle Speed (min ⁻¹)	Feed Rate (mm/min)	a_p Axial Depth (mm)	a_e Radial Depth (mm)	Spindle Speed (min ⁻¹)	Feed Rate (mm/min)	a_p Axial Depth (mm)	a_e Radial Depth (mm)
2001-0010	R0.05	0.1	48,000	200	0.005	0.01	48,000	200	0.005	0.01	48,000	150	0.003	0.006	40,000	120	0.002	0.004
20015-0015	R0.075	0.15	48,000	230	0.007	0.014	48,000	230	0.007	0.014	48,000	170	0.005	0.01	40,000	135	0.003	0.006
2002-0030	R0.1	0.3	44,000	250	0.01	0.03	42,000	250	0.01	0.03	40,000	200	0.008	0.024	36,000	150	0.006	0.018
2003-0030	R0.15	0.3	44,000	400	0.01	0.03	42,000	350	0.01	0.03	40,000	300	0.01	0.03	36,000	250	0.008	0.024
2003-0045		0.45	44,000	400	0.01	0.03	42,000	350	0.01	0.03	40,000	300	0.01	0.03	36,000	250	0.008	0.024
2004-0040	R0.2	0.4	44,000	600	0.015	0.045	42,000	550	0.015	0.045	40,000	500	0.013	0.036	36,000	350	0.01	0.027
2004-0060		0.6	44,000	600	0.015	0.045	42,000	550	0.015	0.045	40,000	500	0.013	0.036	36,000	350	0.01	0.027
2005-0050	R0.25	0.5	44,000	900	0.02	0.065	40,000	800	0.015	0.05	36,000	600	0.015	0.05	30,000	400	0.015	0.03
2005-0075		0.75	44,000	900	0.02	0.065	40,000	800	0.015	0.05	36,000	600	0.015	0.05	30,000	400	0.015	0.03
2006-0060	R0.3	0.6	40,000	1,400	0.045	0.15	36,000	1,200	0.025	0.13	32,000	1,000	0.02	0.1	25,000	600	0.02	0.1
2006-0090		0.9	40,000	1,400	0.045	0.15	36,000	1,200	0.025	0.13	32,000	1,000	0.02	0.1	25,000	600	0.02	0.1
2008-0120	R0.4	1.2	35,000	1,600	0.06	0.21	30,000	1,600	0.04	0.17	26,000	1,350	0.04	0.15	20,000	700	0.02	0.12
2010-0150	R0.5	1.5	30,000	1,750	0.2	0.4	24,000	2,000	0.1	0.3	21,000	1,750	0.05	0.2	16,000	875	0.05	0.2
2015-0225	R0.75	2.25	30,000	2,450	0.25	0.55	17,000	2,000	0.12	0.4	15,000	1,750	0.06	0.29	11,250	875	0.06	0.29
2020-0300	R1	3	28,000	2,900	0.3	0.7	14,000	2,100	0.15	0.5	14,700	2,160	0.1	0.35	11,040	1,080	0.08	0.35
2025-0375	R1.25	3.75	24,500	2,950	0.35	0.85	12,250	2,150	0.17	0.6	12,840	2,220	0.12	0.45	9,660	1,110	0.1	0.45
2030-0450	R1.5	4.5	21,000	3,000	0.4	1	10,500	2,200	0.2	0.7	11,040	2,280	0.15	0.55	8,280	1,140	0.12	0.55
2040-0600	R2	6	18,000	3,200	0.5	1.3	9,000	2,300	0.25	0.95	9,480	2,400	0.18	0.75	7,080	1,200	0.15	0.75
2050-0750	R2.5	7.5	15,600	3,500	0.5	1.5	7,800	2,500	0.25	1.05	8,160	2,520	0.2	0.85	6,120	1,260	0.15	0.85
2060-0900	R3	9	13,000	3,500	0.6	1.8	6,500	2,500	0.3	1.3	6,840	2,640	0.25	1	5,000	1,500	0.2	1

a_p : Axial Depth (mm)
 a_e : Radial Depth (mm)

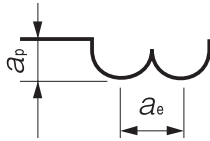

Note:

- Decrease the feed rate more than 50% from the milling parameters when slot milling.
- Decrease both spindle speed and feed rate proportionally when the milling parameters exceed the machines maximum speed, or when the tool is chattering and heats up to a red color.
- Every coolant offers stable milling.

Wear Comparison HGB R3 × Length of Cut 9

HAP10 (64HRC)

Tools after milling

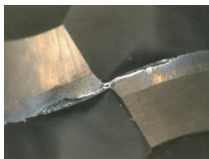

Conventional



HGB

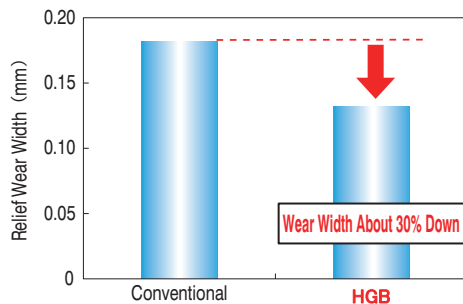

Tool	HGB 2060-0900
Spindle Speed	6,840 min ⁻¹
Feed Rate	2,640 mm/min
Axial Depth a_p	0.25 mm
Radial Depth a_e	1 mm
Coolant	Air Blow (Through Spindle)
Milling Shape	Square Pocket (55 x 17.5 x Depth 6.9 mm) × 5 Pockets
Cycle Time	75 min

* Refer to page 581 for tool geometry, and page 582 for milling examples.

UDC Series

CBN Series

Square

Long Neck Square

Radius

Long Neck Radius

Taper Neck Radius

Ball / Long Shank Ball

Long Neck Ball

Taper Neck Ball

Taper

Spiral V Cutter

Drill

EURO Series

Technical Data



Size R0.03~R6

HSB



Additional 1 model

Material Applications (☆ Highly Recommended ○ Recommended ○ Suggested)

Work Material															
Carbon Steels S45C S55C	Alloy Steels SK / SCM SUS	Prehardened Steels NAK HPM	Hardened Steels			Cast Iron	Aluminum Alloys	Graphite	Copper	Plastics	Glass Filled Plastics	Titanium Alloys	Heat Resistant Alloys	Cemented Carbide	Hard Brittle (Non-Metallic) Materials
			~55HRC	~60HRC	~70HRC										
○	○	○	○	○	○	○						○	○		

Features

Offers high efficiency, long tool life and excellent surface finish on hard materials over 40HRC.

HARDMAX coat offers heat resistance, durability and lubricity at a high level.

Every coolant offers stable milling.

Ball tip point is designed with a negative rake angle that minimizes wear and improves the target dimensions.

The low negative rake angle at the peripheral side of the ball offers an excellent surface finish and prevents deflection.

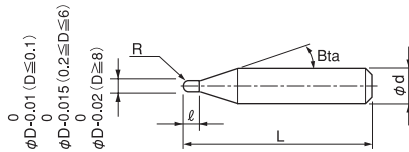

The shank taper angle shown is not an exact value and to avoid contact with the work piece, we recommend the user controls the precise value of this angle. Shank taper angle should not make contact with the work piece.

ATTENTION

HSB 1001-0020-6 (R0.05) is a tapered ball end mill with single tapered flute of 10° (See the figure on right).

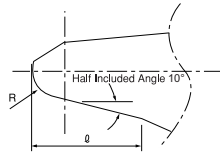

Radius of Ball Nose	Diameter Tolerance	Radius Accuracy	Helix Angle	Number of Flutes
R0.03 ~ R0.05	0/-0.01	±0.002	0°	2 Flutes *
R0.1 ~ R3	0/-0.015	±0.005	30°	
R4 ~ R6	0/-0.02	±0.007		

* Only HSB 1001-0020-6 has single flute.
R accuracy: ±0.005, Diameter tolerance: 0/-0.015

Total 71 models

Unit (mm)

Model Number	Radius of Ball Nose R	Length of Cut l	Shank Taper Angle Bta	Overall Length L	Shank Diameter phi d	Price ¥
HSB 20006-0006	R0.03	0.06	11°	50	4	17,460
HSB 20008-0008	R0.04	0.08	11°	50	4	14,550
HSB 1001-0020-6	R0.05	0.2	11°	50	6	13,320
HSB 2001-0010	R0.05	0.1	11°	50	4	12,120
HSB 2002-0020-6	R0.1	0.2	16°	50	6	9,840
HSB 2002-0030		0.3		50	4	8,520
HSB 2003-0030	R0.15	0.3	16°	50	4	6,960
HSB 2003-0030-6		0.3		50	6	8,400
HSB 2003-0045		0.45		50	4	6,960
HSB 2004-0040	R0.2	0.4	16°	50	4	4,680
HSB 2004-0040-6		0.4		50	6	6,120
HSB 2004-0060		0.6		50	4	4,680
HSB 2005-0050		0.5		50	4	4,320
HSB 2005-0050-6	R0.25	0.5	16°	50	6	5,760
HSB 2005-0075		0.75		50	4	4,320

- UDC Series
- CBN Series
- Square
- Long Neck Square
- Radius
- Long Neck Radius
- Taper Neck Radius
- Ball / Long Shank Ball
- Long Neck Ball
- Taper Neck Ball
- Taper
- Spiral V Cutter
- Drill
- EURO Series
- Technical Data

Unit (mm)

Model Number	Radius of Ball Nose R	Length of Cut ϱ	Shank Taper Angle B α	Overall Length L	Shank Diameter ϕd	Price ¥
HSB 2006-0060	R0.3	0.6	16°	50	4	4,200
HSB 2006-0060-6		0.6		50	6	5,520
HSB 2006-0090		0.9		50	4	4,200
HSB 2007-0100	R0.35	1	16°	50	4	8,000
HSB 2008-0080	R0.4	0.8	16°	50	4	4,200
HSB 2008-0080-6		0.8		50	6	5,520
HSB 2008-0120		1.2		50	4	4,200
HSB 2009-0130	R0.45	1.3	16°	50	4	8,000
HSB 2010-0100	R0.5	1	16°	50	4	3,840
HSB 2010-0100-6		1		50	6	5,160
HSB 2010-0150		1.5		50	4	3,840
HSB 2010-0250		2.5		50	4	3,840
HSB 2011-0160	R0.55	1.6	16°	50	4	9,280
HSB 2012-0180	R0.6	1.8	16°	50	4	5,400
HSB 2013-0190	R0.65	1.9	16°	50	4	9,280
HSB 2014-0210	R0.7	2.1	16°	50	4	5,400
HSB 2015-0150	R0.75	1.5	16°	50	4	4,680
HSB 2015-0150-6		1.5		50	6	6,000
HSB 2015-0200		2		50	4	4,680
HSB 2015-0225		2.25		50	4	4,680
HSB 2015-0400		4		50	4	4,680
HSB 2016-0240	R0.8	2.4	16°	50	4	5,400
HSB 2017-0250	R0.85	2.5	16°	50	4	9,280
HSB 2018-0270	R0.9	2.7	16°	50	4	8,000
HSB 2019-0280	R0.95	2.8	16°	50	4	9,280
HSB 2020-0200	R1	2	16°	50	4	3,480
HSB 2020-0200-6		2		60	6	4,680
HSB 2020-0300		3		50	4	3,480
HSB 2020-0600		6		60	4	3,480
HSB 2025-0250	R1.25	2.5	16°	50	4	5,950
HSB 2025-0250-6		2.5		60	6	6,360
HSB 2025-0375		3.75		50	4	5,950
HSB 2025-0600		6		60	4	5,950
HSB 2030-0300	R1.5	3	16°	50	6	4,200
HSB 2030-0450		4.5		70	6	4,200
HSB 2030-0800		8		70	6	4,200
HSB 2040-0400	R2	4	16°	50	6	4,800
※ HSB 2040-0600-4		6	—	70	4	4,300
HSB 2040-0600		6	16°	70	6	4,800
HSB 2040-0800		8	16°	70	6	4,800
HSB 2050-0500	R2.5	5	16°	50	6	5,710
HSB 2050-0750		7.5		80	6	5,760
HSB 2050-0800		8		80	6	5,760
HSB 2050-1200		12		80	6	5,760
HSB 2060-0600	R3	6	—	50	6	5,940
HSB 2060-0900		9		80	6	6,000
HSB 2060-1200		12		80	6	6,000
HSB 2080-0800	R4	8	—	60	8	9,270
HSB 2080-1200		12		90	8	9,360
HSB 2080-1400		14		90	8	9,360
HSB 2100-1000	R5	10	—	70	10	12,110
HSB 2100-1500		15		100	10	12,240
HSB 2100-1800		18		100	10	12,240
HSB 2120-1200	R6	12	—	75	12	20,580
HSB 2120-1800		18		110	12	20,790
HSB 2120-2200		22		110	12	20,790

※Additional model

UDC Series

CBN Series

Square

Long Neck Square

Radius

Long Neck Radius

Taper Neck Radius

Ball / Long Shank Ball

Long Neck Ball

Taper Neck Ball

Taper

Spiral V Cutter

Drill

EURO Series

Technical Data

Milling Conditions for HSB / HSB-S

WORK MATERIAL			PREHARDENED STEELS HARDENED STEELS NAK / STAVAX (~55HRC)				HARDENED STEELS SKD11 (55~62HRC)				HARDENED STEELS HAP10 (62~66HRC)				HARDENED STEELS HAP72 (66~70HRC)			
Model Number	Radius of Ball Nose (mm)	Length of Cut (mm)	Spindle Speed (min ⁻¹)	Feed Rate (mm/min)	a _p Axial Depth (mm)	a _e Radial Depth (mm)	Spindle Speed (min ⁻¹)	Feed Rate (mm/min)	a _p Axial Depth (mm)	a _e Radial Depth (mm)	Spindle Speed (min ⁻¹)	Feed Rate (mm/min)	a _p Axial Depth (mm)	a _e Radial Depth (mm)	Spindle Speed (min ⁻¹)	Feed Rate (mm/min)	a _p Axial Depth (mm)	a _e Radial Depth (mm)
20006-0006	R0.03	0.06	30,000	100	0.002 or below	0.02	—	—	—	—	—	—	—	—	—	—	—	—
20008-0008	R0.04	0.08	30,000	130	0.003 or below	0.03	—	—	—	—	—	—	—	—	—	—	—	—
1001-0020-6	R0.05	0.2	30,000	30	0.002 or below	0.02	—	—	—	—	—	—	—	—	—	—	—	—
2001-0010		0.1	30,000	200	0.004 or below	0.04	—	—	—	—	—	—	—	—	—	—	—	—
2002-0020(-6)	R0.1	0.2	60,000	200	0.003	0.005	60,000	200	0.002	0.003	60,000	130	0.002	0.003	45,000	65	0.002	0.003
2002-0030		0.3	60,000	200	0.003	0.005	60,000	200	0.002	0.003	60,000	130	0.002	0.003	45,000	65	0.002	0.003
2003-0030(-6)	R0.15	0.3	60,000	350	0.006	0.008	45,000	310	0.004	0.007	43,500	180	0.003	0.005	32,500	90	0.003	0.005
2003-0045		0.45	60,000	350	0.006	0.008	45,000	310	0.004	0.007	43,500	180	0.003	0.005	32,500	90	0.003	0.005
2004-0040(-6)	R0.2	0.4	50,000	500	0.01	0.02	37,500	420	0.007	0.012	35,000	240	0.005	0.008	26,250	120	0.005	0.008
2004-0060		0.6	50,000	500	0.01	0.02	37,500	420	0.007	0.012	35,000	240	0.005	0.008	26,250	120	0.005	0.008
2005-0050(-6)	R0.25	0.5	44,000	650	0.015	0.04	33,000	530	0.01	0.02	30,000	300	0.007	0.01	22,500	150	0.007	0.01
2005-0075		0.75	44,000	650	0.015	0.04	33,000	530	0.01	0.02	30,000	300	0.007	0.01	22,500	150	0.007	0.01
2006-0060(-6)	R0.3	0.6	40,000	1,100	0.03	0.13	30,000	1,200	0.02	0.1	26,500	800	0.01	0.075	20,000	400	0.01	0.075
2006-0090		0.9	40,000	1,100	0.03	0.13	30,000	1,200	0.02	0.1	26,500	800	0.01	0.075	20,000	400	0.01	0.075
2007-0100	R0.35	1	37,000	1,350	0.045	0.17	28,500	1,400	0.03	0.135	25,000	900	0.015	0.1	18,750	450	0.015	0.1
2008-0080(-6)	R0.4	0.8	35,000	1,600	0.06	0.21	27,000	1,600	0.04	0.17	23,500	1,000	0.02	0.12	17,500	500	0.02	0.12
2008-0120		1.2	35,000	1,600	0.06	0.21	27,000	1,600	0.04	0.17	23,500	1,000	0.02	0.12	17,500	500	0.02	0.12
2009-0130	R0.45	1.3	32,500	1,650	0.1	0.28	25,500	1,800	0.055	0.21	22,000	1,300	0.025	0.14	16,500	650	0.025	0.14
2010-0100(-6)	R0.5	1	30,000	1,750	0.2	0.4	24,000	2,000	0.1	0.3	21,000	1,750	0.05	0.2	16,000	875	0.05	0.2
2010-0150		1.5	30,000	1,750	0.2	0.4	24,000	2,000	0.1	0.3	21,000	1,750	0.05	0.2	16,000	875	0.05	0.2
2010-0250		2.5	30,000	1,750	0.1	0.3	24,000	2,000	0.05	0.2	21,000	1,750	0.03	0.17	16,000	875	0.03	0.17
2011-0160	R0.55	1.6	30,000	1,900	0.21	0.43	22,000	2,000	0.105	0.32	19,000	1,750	0.05	0.22	14,250	875	0.05	0.22
2012-0180	R0.6	1.8	30,000	2,000	0.22	0.46	20,500	2,000	0.11	0.34	17,800	1,750	0.05	0.23	13,350	875	0.05	0.23
2013-0190	R0.65	1.9	30,000	2,150	0.23	0.49	19,000	2,000	0.115	0.36	16,600	1,750	0.05	0.24	12,450	875	0.05	0.24
2014-0210	R0.7	2.1	30,000	2,300	0.24	0.52	18,000	2,000	0.12	0.39	15,700	1,750	0.055	0.27	11,800	875	0.055	0.27
2015-0150(-6)	R0.75	1.5	30,000	2,450	0.25	0.55	17,000	2,000	0.12	0.4	15,000	1,750	0.06	0.29	11,250	875	0.06	0.29
2015-0200		2	30,000	2,450	0.25	0.55	17,000	2,000	0.12	0.4	15,000	1,750	0.06	0.29	11,250	875	0.06	0.29
2015-0225		2.25	30,000	2,450	0.25	0.55	17,000	2,000	0.12	0.4	15,000	1,750	0.06	0.29	11,250	875	0.06	0.29
2015-0400		4	30,000	2,450	0.15	0.45	17,000	2,000	0.07	0.31	15,000	1,750	0.04	0.24	11,250	875	0.04	0.24
2016-0240	R0.8	2.4	30,000	2,550	0.25	0.58	16,200	2,000	0.13	0.43	14,200	1,750	0.06	0.3	10,650	875	0.06	0.3
2017-0250	R0.85	2.5	30,000	2,600	0.26	0.61	15,500	2,000	0.135	0.46	13,500	1,750	0.065	0.32	10,100	875	0.065	0.32
2018-0270	R0.9	2.7	30,000	2,700	0.28	0.65	15,000	2,000	0.14	0.48	13,000	1,750	0.07	0.34	9,750	875	0.07	0.34
2019-0280	R0.95	2.8	29,000	2,800	0.3	0.69	14,500	2,000	0.145	0.49	12,600	1,750	0.075	0.36	9,450	875	0.075	0.36
2020-0200(-6)	R1	2	28,000	2,900	0.3	0.7	14,000	2,100	0.15	0.5	12,250	1,800	0.08	0.35	9,200	900	0.08	0.35
2020-0300		3	28,000	2,900	0.3	0.7	14,000	2,100	0.15	0.5	12,250	1,800	0.08	0.35	9,200	900	0.08	0.35
2020-0600		6	28,000	2,900	0.2	0.6	14,000	2,100	0.1	0.4	12,250	1,800	0.06	0.3	9,200	900	0.06	0.3
2025-0250(-6)	R1.25	2.5	24,500	2,950	0.35	0.85	12,250	2,150	0.17	0.6	10,700	1,850	0.1	0.45	8,050	925	0.1	0.45
2025-0375		3.75	24,500	2,950	0.35	0.85	12,250	2,150	0.17	0.6	10,700	1,850	0.1	0.45	8,050	925	0.1	0.45
2025-0600		6	24,500	2,950	0.26	0.75	12,250	2,150	0.125	0.5	10,700	1,850	0.08	0.4	8,050	925	0.08	0.4
2030-0300	R1.5	3	21,000	3,000	0.4	1	10,500	2,200	0.2	0.7	9,200	1,900	0.12	0.55	6,900	950	0.12	0.55
2030-0450		4.5	21,000	3,000	0.4	1	10,500	2,200	0.2	0.7	9,200	1,900	0.12	0.55	6,900	950	0.12	0.55
2030-0800		8	21,000	3,000	0.3	0.9	10,500	2,200	0.15	0.65	9,200	1,900	0.1	0.5	6,900	950	0.1	0.5
2040-0400	R2	4	18,000	3,200	0.5	1.3	9,000	2,300	0.25	0.95	7,900	2,000	0.15	0.75	5,900	1,000	0.15	0.75
2040-0600(-4)		6	18,000	3,200	0.5	1.3	9,000	2,300	0.25	0.95	7,900	2,000	0.15	0.75	5,900	1,000	0.15	0.75
2040-0800		8	18,000	3,200	0.5	1.3	9,000	2,300	0.25	0.95	7,900	2,000	0.15	0.75	5,900	1,000	0.15	0.75
2050-0500	R2.5	5	15,600	3,500	0.5	1.5	7,800	2,500	0.25	1.05	6,800	2,100	0.15	0.85	5,100	1,050	0.15	0.85
2050-0750		7.5	15,600	3,500	0.5	1.5	7,800	2,500	0.25	1.05	6,800	2,100	0.15	0.85	5,100	1,050	0.15	0.85
2050-0800		8	15,600	3,500	0.5	1.5	7,800	2,500	0.25	1.05	6,800	2,100	0.15	0.85	5,100	1,050	0.15	0.85
2050-1200		12	15,600	3,500	0.5	1.5	7,800	2,500	0.25	1.05	6,800	2,100	0.15	0.85	5,100	1,050	0.15	0.85

- UDC Series
- CBN Series
- Square
- Long Neck Square
- Radius
- Long Neck Radius
- Taper Neck Radius
- Ball / Long Shank Ball
- Long Neck Ball
- Taper Neck Ball
- Taper
- Spiral V Cutter
- Drill
- EURO Series
- Technical Data

Milling Conditions for HSB / HSB-S

WORK MATERIAL			PREHARDENED STEELS HARDENED STEELS NAK / STAVAX (~55HRC)				HARDENED STEELS SKD11 (55~62HRC)				HARDENED STEELS HAP10 (62~66HRC)				HARDENED STEELS HAP72 (66~70HRC)			
Model Number	Radius of Ball Nose (mm)	Length of Cut (mm)	Spindle Speed (min ⁻¹)	Feed Rate (mm/min)	a _p Axial Depth (mm)	a _e Radial Depth (mm)	Spindle Speed (min ⁻¹)	Feed Rate (mm/min)	a _p Axial Depth (mm)	a _e Radial Depth (mm)	Spindle Speed (min ⁻¹)	Feed Rate (mm/min)	a _p Axial Depth (mm)	a _e Radial Depth (mm)	Spindle Speed (min ⁻¹)	Feed Rate (mm/min)	a _p Axial Depth (mm)	a _e Radial Depth (mm)
2060-0600	R3	6	13,000	3,500	0.6	1.8	6,500	2,500	0.3	1.3	5,700	2,200	0.2	1	4,300	1,100	0.2	1
2060-0900		9	13,000	3,500	0.6	1.8	6,500	2,500	0.3	1.3	5,700	2,200	0.2	1	4,300	1,100	0.2	1
2060-1200		12	13,000	3,500	0.6	1.8	6,500	2,500	0.3	1.3	5,700	2,200	0.2	1	4,300	1,100	0.2	1
2080-0800	R4	8	9,500	3,000	0.7	2.1	5,200	2,200	0.4	1.7	4,500	1,900	0.25	1.35	3,400	950	0.25	1.35
2080-1200		12	9,500	3,000	0.7	2.1	5,200	2,200	0.4	1.7	4,500	1,900	0.25	1.35	3,400	950	0.25	1.35
2080-1400		14	9,500	3,000	0.7	2.1	5,200	2,200	0.4	1.7	4,500	1,900	0.25	1.35	3,400	950	0.25	1.35
2100-1000	R5	10	7,500	2,500	0.8	2.5	4,300	2,000	0.5	2.1	3,750	1,750	0.3	1.7	2,800	875	0.3	1.7
2100-1500		15	7,500	2,500	0.8	2.5	4,300	2,000	0.5	2.1	3,750	1,750	0.3	1.7	2,800	875	0.3	1.7
2100-1800		18	7,500	2,500	0.8	2.5	4,300	2,000	0.5	2.1	3,750	1,750	0.3	1.7	2,800	875	0.3	1.7
2120-1200	R6	12	6,200	2,000	0.9	3	3,600	1,750	0.6	2.6	3,150	1,500	0.35	2	2,350	750	0.35	2
2120-1800		18	6,200	2,000	0.9	3	3,600	1,750	0.6	2.6	3,150	1,500	0.35	2	2,350	750	0.35	2
2120-2200		22	6,200	2,000	0.9	3	3,600	1,750	0.6	2.6	3,150	1,500	0.35	2	2,350	750	0.35	2

a_p : Axial Depth (mm)
a_e : Radial Depth (mm)

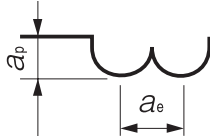

- Note:
- Decrease the feed rate more than 50% from the milling parameters when slot milling.
 - Decrease both spindle speed and feed rate proportionally when the milling parameters exceed the machines maximum speed, or when the tool is chattering and heats up to a red color.
 - Reduce the milling parameters when a straight shank tool exceeds 35 mm of overhang length.
 - Every coolant offers stable milling.

R3 Ball Tool Life Comparison: Market Leading Performance on Wear Resistance!

HSB offers the highest wear resistance for various work materials.

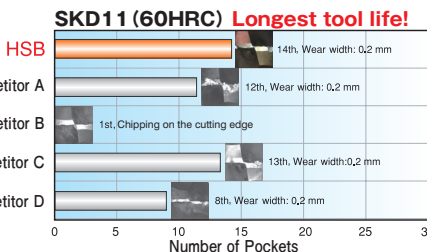
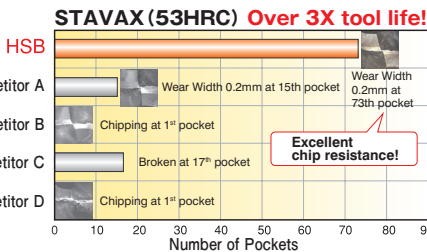

Tool Size: R3

Work Material	STAVAX (53HRC)	SKD11 (60HRC)
Spindle Speed f_n	13,000 min ⁻¹	6,500 min ⁻¹
Feed Rate V_f	3,500 mm/min	2,500 mm/min
Velocity V_c	245 m/min	122 m/min
Feed per tooth f_z	0.135 mm/tooth	0.19 mm/tooth
Axial Depth a_p	0.6 mm	0.3 mm
Radial Depth a_e	1.8 mm	1.3 mm
Overhang Length	30 mm	30 mm
Cycle Time	3 min/pocket	6.5 min/pocket
Coolant	Air Blow	
Milling Method	Contouring	

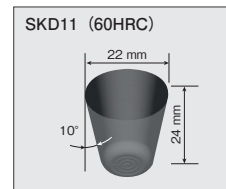
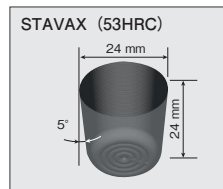

* Refer to page 580 for tool geometry.

UDC Series

CBN Series

Square

Long Neck Square

Radius

Long Neck Radius

Taper Neck Radius

Ball / Long Shank Ball

Long Neck Ball

Taper Neck Ball

Taper

Spiral V Cutter

Drill

EURO Series

Technical Data



Size R0.1~R2

Short Shank Series

HSB-S



Material Applications (☆ Highly Recommended ◎ Recommended ○ Suggested)

Work Material															
Carbon Steels S45C S55C	Alloy Steels SK / SCM SUS	Prehardened Steels NAK HPM	Hardened Steels			Cast Iron	Aluminum Alloys	Graphite	Copper	Plastics	Glass Filled Plastics	Titanium Alloys	Heat Resistant Alloys	Cemented Carbide	Hard Brittle (Non-Metallic) Materials
			~55HRC	~60HRC	~70HRC										
○	○	◎	◎	◎	◎	○			○				○	○	

Features

Short Shank Ball End Mills for high accuracy shrink-fit tool holder.

Offers high efficiency, long tool life and excellent surface finish on hard materials over 40HRC.

HARDMAX coat offers heat resistance, durability and lubricity at a high level.

Every coolant offers stable milling.

Ball tip point is designed with a negative rake angle that minimizes wear and improves the target dimensions.

The low negative rake angle at the peripheral side of the ball offers an excellent surface finish and prevents deflection.

Better Tolerance Design! Diameter Tolerance, Ball Radius Accuracy, and Shank Diameter Tolerance

HSB / HSLB Tolerance

Radius of Ball Nose	Diameter Tolerance	Ball Radius Accuracy	Shank Diameter Tolerance
R0.1 ~ R3	0/-0.015	±0.005	0/-0.005 (h5)

HSB-S / HSLB-S Tolerance

Radius of Ball Nose	Diameter Tolerance	Ball Radius Accuracy	Shank Diameter Tolerance
R0.1 ~ R1	0/-0.008	±0.003	0/-0.004 (h4)
R1.5 ~ R2	0/-0.01		
R3		±0.005	

Shank diameter tolerance h4!

Short overhang length with short shank length!

Conventional series **New Short shank series**

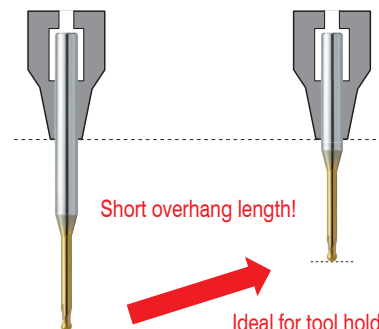

Short overhang length minimizes tool run-out

High precision milling

Minimizes vibration and chattering

Longer tool life

Ideal for tool holders where the maximum insertion is short.

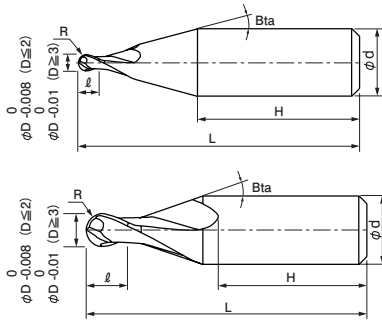

The shank taper angle and the shank length (H) shown are not an exact value and to avoid contact with the work piece, we recommend the user controls the precise value of this angle. Shank taper angle should not make contact with the work piece.

Total 10 models

Unit (mm)

Model Number	Radius of Ball Nose R	Length of Cut ℓ	Shank Taper Angle B α	Overall Length L	Shank Diameter ϕd	Shank Length H	Price ¥
HSB 2002-0020S	RO.1	0.2	16°	35	4	26.0	8,520
HSB 2003-0030S	RO.15	0.3	16°	35	4	26.0	6,960
HSB 2004-0040S	RO.2	0.4	16°	35	4	26.0	4,680
HSB 2006-0060S	RO.3	0.6	16°	35	4	26.0	4,200
HSB 2008-0080S	RO.4	0.8	16°	35	4	26.5	4,200
HSB 2010-0100S	RO.5	1	16°	35	4	26.5	3,840
HSB 2015-0150S	RO.75	1.5	16°	35	4	26.5	4,680
HSB 2020-0200S	R1	2	16°	35	4	25.5	3,480
HSB 2030-0300S	R1.5	3	16°	40	6	27.0	4,200
HSB 2040-0400S	R2	4	16°	40	6	26.0	4,800

UDC Series

CBN Series

Square

Long Neck Square

Radius

Long Neck Radius

Taper Neck Radius

Ball / Long Shank Ball

Long Neck Ball

Taper Neck Ball

Taper

Spiral V Cutter

Drill

EURO Series

Technical Data



Size R1.5~R6

HBL

Super
MG

HARD
MAX

30°

R
±0.005
R1.5~R3

R
±0.007
R4~R6

Shank Dia
0/-0.005

Material Applications (☆ Highly Recommended ○ Recommended ○ Suggested)

Work Material															
Carbon Steels S45C S55C	Alloy Steels SK / SCM SUS	Prehardened Steels NAK HPM	Hardened Steels			Cast Iron	Aluminum Alloys	Graphite	Copper	Plastics	Glass Filled Plastics	Titanium Alloys	Heat Resistant Alloys	Cemented Carbide	Hard Brittle (Non-Metallic) Materials
			~55HRC	~60HRC	~70HRC										
○	○	○	○	○		○			○			○	○		

Features

Long shank ball design for hard materials.
 HARDMAX coating for high speed milling for hard materials.
 Both dry and wet coolant offer stable and long tool life.
 Diameter Tolerance: 0/-0.015 (D≤6)、0/-0.02 (D≥8)

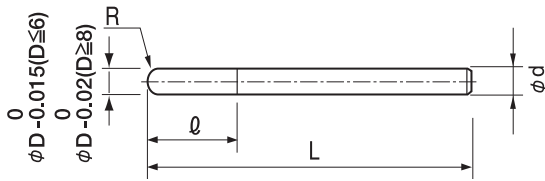

Shank part should not make contact with the work piece.

Total 6 models

Unit (mm)

Model Number	Radius of Ball Nose R	Length of Cut ℓ	Overall Length L	Shank Diameter φd	Price ¥
HBL 2030-0800	R1.5	4.5	80	3	12,200
HBL 2040-1000	R2	6	100	4	13,900
HBL 2060-1400	R3	18	140	6	21,100
HBL 2080-1600	R4	20	160	8	29,480
HBL 2100-1800	R5	25	180	10	35,700
HBL 2120-2000	R6	25	200	12	46,090

Milling Conditions for HBL

WORK MATERIAL		CARBON STEELS S45C / S50C (~225HB)				ALLOY STEELS SK / SCM / SUS (225~325HB)				PREHARDENED STEELS HARDENED STEELS NAK / SKD (30~45HRC)			
Model Number	Radius of Ball Nose (mm)	Spindle Speed (min ⁻¹)	Feed Rate (mm/min)	a_p Axial Depth (mm)	a_e Radial Depth (mm)	Spindle Speed (min ⁻¹)	Feed Rate (mm/min)	a_p Axial Depth (mm)	a_e Radial Depth (mm)	Spindle Speed (min ⁻¹)	Feed Rate (mm/min)	a_p Axial Depth (mm)	a_e Radial Depth (mm)
2030-0800	R1.5	16,000	800	0.12	0.3	13,300	580	0.12	0.3	10,700	420	0.12	0.3
2040-1000	R2	12,000	840	0.16	0.4	10,000	560	0.16	0.4	8,000	400	0.16	0.4
2060-1400	R3	8,000	960	0.24	0.6	6,700	670	0.24	0.6	5,400	480	0.24	0.6
2080-1600	R4	6,000	1,050	0.32	0.8	5,000	700	0.32	0.8	4,000	520	0.32	0.8
2100-1800	R5	4,800	1,100	0.4	1	4,000	730	0.4	1	3,200	540	0.4	1
2120-2000	R6	4,000	1,130	0.48	1.2	3,400	810	0.48	1.2	2,700	590	0.48	1.2

WORK MATERIAL		HARDENED STEELS SKD61 / SKT (45~50HRC)				HARDENED STEELS SKD61 / 11 (50~60HRC)			
Model Number	Radius of Ball Nose (mm)	Spindle Speed (min ⁻¹)	Feed Rate (mm/min)	a_p Axial Depth (mm)	a_e Radial Depth (mm)	Spindle Speed (min ⁻¹)	Feed Rate (mm/min)	a_p Axial Depth (mm)	a_e Radial Depth (mm)
2030-0800	R1.5	6,400	230	0.12	0.3	4,800	90	0.12	0.3
2040-1000	R2	4,800	230	0.16	0.4	3,600	100	0.16	0.4
2060-1400	R3	3,200	250	0.24	0.6	2,400	110	0.24	0.6
2080-1600	R4	2,400	260	0.32	0.8	1,800	110	0.32	0.8
2100-1800	R5	2,000	300	0.4	1	1,500	120	0.4	1
2120-2000	R6	1,600	320	0.48	1.2	1,200	140	0.48	1.2

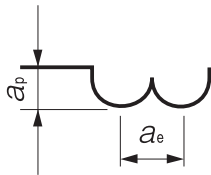

Cutting Amount (mm)
 $a_p = 0.04D$ (Max 0.5 mm)
 $a_e = 0.1D$
 a_p : Axial Depth (mm)
 a_e : Radial Depth (mm)
 D : Outside Diameter (mm)

Note:

- Decrease both spindle speed and feed rate proportionally in case of chattering.
- Set spindle speed, feed rate, and radial depth (a_e) in accordance with the required surface quality.
- Adjust milling parameters according to the operating environment when milling a work piece over 60HRC.
- Recommend air blow or oil mist.
- Recommend oil coolant for Stainless Steels and Heat Resistant Alloys.
- Recommend wet coolant for Copper.

UDC Series

CBN Series

Square

Long Neck Square

Radius

Long Neck Radius

Taper Neck Radius

Ball / Long Shank Ball

Long Neck Ball

Taper Neck Ball

Taper

Spiral V Cutter

Drill

EURO Series

Technical Data



Size R0.05~R6

CSEB

Super
MG

UT
COAT

Shank Dia
0/-0.005

Additional 1 model

Material Applications (☆ Highly Recommended ○ Recommended ○ Suggested)

Work Material															
Carbon Steels S45C S55C	Alloy Steels SK / SCM SUS	Prehardened Steels NAK HPM	Hardened Steels			Cast Iron	Aluminum Alloys	Graphite	Copper	Plastics	Glass Filled Plastics	Titanium Alloys	Heat Resistant Alloys	Cemented Carbide	Hard Brittle (Non-Metallic) Materials
			~55HRC	~60HRC	~70HRC										
○	○	○	○				○		○				○		

Features

The optimized geometry offers durability when roughing, yet gives excellent surface quality for finishing. UTCOAT with improved hardness, durability, lubricity and adhesion offers better wear resistance and surface roughness. Broad application range from Copper and raw materials to Hardened Steels (55HRC).

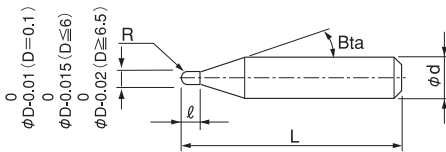

The shank taper angle shown is not an exact value and to avoid contact with the work piece, we recommend the user controls the precise value of this angle. Shank taper angle should not make contact with the work piece.

ATTENTION

CSEB 1001-0020-6 is a tapered ball end mill with single tapered flute of 10° (See the figure on right).

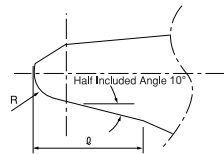

Radius of Ball Nose	Diameter Tolerance	Radius Accuracy	Helix Angle	Number of Flutes
R0.05	0/-0.01	±0.002	0°	2 Flutes *
R0.1 ~ R3	0/-0.015	±0.005	30°	
R3.25 ~ R6	0/-0.02	±0.007		

* Only CSEB 1001-0020-6 has single flute.
R accuracy and diameter tolerance is the same as R0.1.

Total 78 models

Unit (mm)

Model Number	Radius of Ball Nose R	Length of Cut ℓ	Shank Taper Angle Bta	Overall Length L	Shank Diameter φd	Price ¥
CSEB 1001-0020-6	R0.05	0.2	11°	50	6	13,320
CSEB 2001-0010	R0.05	0.1	11°	50	4	12,120
CSEB 2002-0020-6	R0.1	0.2	11°	50	6	9,840
CSEB 2002-0030		0.3		50	4	8,520
CSEB 2003-0030	R0.15	0.3	11°	50	4	6,960
CSEB 2003-0030-6		0.3		50	6	8,400
CSEB 2003-0045		0.45		50	4	6,960
CSEB 2004-0040		0.4		50	4	4,680
CSEB 2004-0040-6	R0.2	0.4	11°	50	6	6,120
CSEB 2004-0060		0.6		50	4	4,680
CSEB 2005-0050	R0.25	0.5	11°	50	4	4,320
CSEB 2005-0050-6		0.5		50	6	5,760
CSEB 2005-0075		0.75		50	4	4,320
CSEB 2006-0060	R0.3	0.6	11°	50	4	4,200
CSEB 2006-0060-6		0.6		50	6	5,520
CSEB 2006-0090		0.9		50	4	4,200
CSEB 2007-0100	R0.35	1	11°	50	4	8,000
CSEB 2008-0080	R0.4	0.8	11°	50	4	4,200
CSEB 2008-0080-6		0.8		50	6	5,520
CSEB 2008-0120		1.2		50	4	4,200

Model Number	Radius of Ball Nose R	Length of Cut ϱ	Shank Taper Angle B α	Overall Length L	Shank Diameter ϕd	Price ¥
CSEB 2009-0130	RO.45	1.3	11°	50	4	8,000
CSEB 2010-0100	RO.5	1	11°	50	4	3,840
CSEB 2010-0100-6		1		50	6	5,160
CSEB 2010-0150		1.5		50	4	3,840
CSEB 2010-0250		2.5		50	4	3,840
CSEB 2011-0160	RO.55	1.6	11°	50	4	9,280
CSEB 2012-0180	RO.6	1.8	11°	50	4	5,400
CSEB 2013-0190	RO.65	1.9	11°	50	4	9,280
CSEB 2014-0210	RO.7	2.1	11°	50	4	5,400
CSEB 2015-0150	RO.75	1.5	11°	50	4	4,680
CSEB 2015-0150-6		1.5		50	6	6,000
CSEB 2015-0200		2		50	4	4,680
CSEB 2015-0225		2.25		50	4	4,680
CSEB 2015-0400		4		50	4	4,680
CSEB 2016-0240	RO.8	2.4	11°	50	4	5,400
CSEB 2017-0250	RO.85	2.5	11°	50	4	9,280
CSEB 2018-0270	RO.9	2.7	11°	50	4	8,000
CSEB 2019-0280	RO.95	2.8	11°	50	4	9,280
CSEB 2020-0200	R1	2	11°	50	4	3,480
CSEB 2020-0200-6		2		60	6	4,680
CSEB 2020-0300		3		60	4	3,480
CSEB 2020-0600		6		60	4	3,480
CSEB 2025-0250	R1.25	2.5	11°	50	4	5,950
CSEB 2025-0250-6		2.5		60	6	7,200
CSEB 2025-0375		3.75		50	4	5,950
CSEB 2025-0600		6		60	4	5,950
CSEB 2030-0300	R1.5	3	11°	50	6	4,200
CSEB 2030-0450		4.5		70	6	4,200
CSEB 2030-0800		8		70	6	4,200
CSEB 2035-0520	R1.75	5.2	11°	70	6	7,800
CSEB 2040-0400	R2	4	11°	50	6	4,800
※ CSEB 2040-0600-4		6	—	70	4	4,300
CSEB 2040-0600		6	11°	70	6	4,800
CSEB 2040-0800		8		70	6	4,800
CSEB 2045-0670	R2.25	6.7	11°	70	6	10,610
CSEB 2050-0500	R2.5	5	11°	50	6	5,710
CSEB 2050-0750		7.5		80	6	5,760
CSEB 2050-0800		8		80	6	5,760
CSEB 2050-1200		12		80	6	5,760
CSEB 2055-0820	R2.75	8.2	11°	80	6	11,660
CSEB 2060-0600	R3	6	—	50	6	5,940
CSEB 2060-0900		9		80	6	6,000
CSEB 2060-1200		12		80	6	6,000
CSEB 2065-0970	R3.25	9.7	11°	90	8	13,200
CSEB 2070-1050	R3.5	10.5	11°	90	8	10,560
CSEB 2075-1120	R3.75	11.2	11°	90	8	13,200
CSEB 2080-0800	R4	8	—	60	8	9,270
CSEB 2080-1200		12		90	8	9,360
CSEB 2080-1400		14		90	8	9,360
CSEB 2085-1270		R4.25		12.7	11°	100
CSEB 2090-1350	R4.5	13.5	11°	100	10	14,630
CSEB 2100-1000	R5	10	—	70	10	12,110
CSEB 2100-1500		15		100	10	12,240
CSEB 2100-1800		18		100	10	12,240
CSEB 2110-1650		R5.5		16.5	11°	110
CSEB 2120-1200	R6	12	—	75	12	20,580
CSEB 2120-1800		18		110	12	20,790
CSEB 2120-2200		22		110	12	20,790

※Additional model

UDC Series

CBN Series

Square
Long Neck Square

Radius

Long Neck Radius

Taper Neck Radius

Ball / Long Shank Ball

Long Neck Ball

Taper Neck Ball

Taper

Spiral V Cutter

Drill

EURO Series

Technical Data

Milling Conditions for CSEB

WORK MATERIAL			COPPER / ALUMINUM ALLOYS				CARBON STEELS / ALLOY STEELS S45C / S50C / SK / SCM (~325HB)				PREHARDENED STEELS NAK80 / STAVAX / HPM38 (30~45HRC)				HARDENED STEELS STAVAX / HPM38 / SKD61 (45~55HRC)			
Model Number	Radius of Ball Nose (mm)	Length of Cut (mm)	Spindle Speed (min ⁻¹)	Feed Rate (mm/min)	a _p Axial Depth (mm)	a _e Radial Depth (mm)	Spindle Speed (min ⁻¹)	Feed Rate (mm/min)	a _p Axial Depth (mm)	a _e Radial Depth (mm)	Spindle Speed (min ⁻¹)	Feed Rate (mm/min)	a _p Axial Depth (mm)	a _e Radial Depth (mm)	Spindle Speed (min ⁻¹)	Feed Rate (mm/min)	a _p Axial Depth (mm)	a _e Radial Depth (mm)
1001-0020-6	R0.05	0.2	30,000	30	0.002 or below	0.02	30,000	30	0.002 or below	0.02	30,000	30	0.002 or below	0.02	30,000	30	0.002 or below	0.02
2001-0010		0.1	30,000	200	0.004 or below	0.04	30,000	200	0.004 or below	0.04	30,000	200	0.004 or below	0.04	30,000	200	0.004 or below	0.04
2002-0020-6	R0.1	0.2	60,000	350	0.008	0.024	60,000	350	0.008	0.016	60,000	300	0.008	0.024	60,000	300	0.006	0.018
2002-0030		0.3	60,000	350	0.008	0.024	60,000	350	0.008	0.016	60,000	300	0.008	0.024	60,000	300	0.006	0.018
2003-0030(-6)	R0.15	0.3	43,000	500	0.012	0.036	43,000	500	0.012	0.024	54,000	450	0.012	0.036	43,000	450	0.008	0.024
2003-0045		0.45	43,000	500	0.012	0.036	43,000	500	0.012	0.024	54,000	450	0.012	0.036	43,000	450	0.008	0.024
2004-0040(-6)	R0.2	0.4	35,000	1,200	0.03	0.09	35,000	1,200	0.02	0.04	50,000	650	0.025	0.075	35,000	650	0.015	0.045
2004-0060		0.6	35,000	1,200	0.03	0.09	35,000	1,200	0.02	0.04	50,000	650	0.025	0.075	35,000	650	0.015	0.045
2005-0050(-6)	R0.25	0.5	34,000	1,300	0.035	0.105	34,000	1,300	0.03	0.06	45,000	900	0.03	0.09	32,000	900	0.02	0.06
2005-0075		0.75	34,000	1,300	0.035	0.105	34,000	1,300	0.03	0.06	45,000	900	0.03	0.09	32,000	900	0.02	0.06
2006-0060(-6)	R0.3	0.6	33,000	1,500	0.05	0.15	33,000	1,500	0.04	0.08	40,000	1,300	0.045	0.09	30,000	1,300	0.04	0.06
2006-0090		0.9	33,000	1,500	0.05	0.15	33,000	1,500	0.04	0.08	40,000	1,300	0.045	0.09	30,000	1,300	0.04	0.06
2007-0100	R0.35	1	32,000	1,800	0.07	0.21	32,000	1,600	0.05	0.1	38,000	1,600	0.06	0.12	28,000	1,600	0.05	0.075
2008-0080(-6)	R0.4	0.8	30,000	2,200	0.1	0.3	30,000	1,800	0.06	0.12	35,000	1,800	0.07	0.14	25,000	1,700	0.07	0.1
2008-0120		1.2	30,000	2,200	0.1	0.3	30,000	1,800	0.06	0.12	35,000	1,800	0.07	0.14	25,000	1,700	0.07	0.1
2009-0130	R0.45	1.3	30,000	2,100	0.11	0.33	30,000	1,600	0.07	0.14	33,000	1,700	0.08	0.16	24,000	1,600	0.08	0.12
2010-0100(-6)	R0.5	1	30,000	2,000	0.12	0.36	30,000	1,600	0.08	0.16	30,000	1,600	0.09	0.18	22,000	1,600	0.09	0.13
2010-0150		1.5	30,000	2,000	0.12	0.36	30,000	1,600	0.08	0.16	30,000	1,500	0.09	0.18	22,000	1,600	0.09	0.13
2010-0250		2.5	30,000	1,700	0.09	0.27	24,000	1,400	0.06	0.12	30,000	1,300	0.075	0.15	21,500	1,300	0.075	0.1
2011-0160	R0.55	1.6	30,000	2,000	0.12	0.36	30,000	1,600	0.08	0.16	30,000	1,600	0.09	0.18	20,000	1,600	0.09	0.13
2012-0180	R0.6	1.8	30,000	2,000	0.13	0.39	30,000	1,600	0.09	0.18	30,000	1,600	0.1	0.2	18,000	1,600	0.1	0.15
2013-0190	R0.65	1.9	30,000	2,000	0.13	0.39	30,000	1,600	0.09	0.18	30,000	1,700	0.1	0.2	18,000	1,500	0.1	0.15
2014-0210	R0.7	2.1	30,000	2,000	0.14	0.42	30,000	1,500	0.1	0.2	30,000	1,700	0.11	0.2	18,000	1,500	0.11	0.16
2015-0150(-6)	R0.75	1.5	30,000	2,000	0.15	0.45	30,000	1,600	0.12	0.24	30,000	1,700	0.12	0.24	18,000	1,500	0.12	0.18
2015-0200		2	30,000	2,000	0.15	0.45	30,000	1,600	0.12	0.24	30,000	1,700	0.12	0.24	18,000	1,500	0.12	0.18
2015-0225		2.25	30,000	2,000	0.15	0.45	30,000	1,600	0.12	0.24	30,000	1,700	0.12	0.24	18,000	1,500	0.12	0.18
2015-0400		4	30,000	1,800	0.12	0.36	23,000	1,200	0.08	0.16	30,000	1,400	0.1	0.2	15,000	1,200	0.09	0.13
2016-0240	R0.8	2.4	30,000	2,000	0.16	0.48	30,000	1,600	0.12	0.24	30,000	1,800	0.12	0.36	18,000	1,400	0.1	0.2
2017-0250	R0.85	2.5	30,000	2,000	0.17	0.51	30,000	1,700	0.14	0.28	30,000	1,800	0.14	0.42	18,000	1,400	0.12	0.24
2018-0270	R0.9	2.7	30,000	2,000	0.18	0.54	30,000	1,800	0.16	0.32	30,000	1,900	0.16	0.48	16,000	1,300	0.14	0.28
2019-0280	R0.95	2.8	30,000	2,000	0.19	0.57	30,000	1,900	0.18	0.36	30,000	1,900	0.18	0.54	16,000	1,300	0.16	0.32
2020-0200(-6)	R1	2	30,000	2,000	0.2	0.6	30,000	2,000	0.21	0.42	30,000	2,000	0.2	0.6	16,000	1,300	0.17	0.5
2020-0300		3	30,000	2,000	0.2	0.6	30,000	2,000	0.21	0.42	30,000	2,000	0.2	0.6	16,000	1,300	0.17	0.5
2020-0600		6	30,000	2,000	0.2	0.6	30,000	2,000	0.14	0.42	30,000	2,000	0.13	0.45	10,800	850	0.1	0.4

- UDC Series
- CBN Series
- Square
- Long Neck Square
- Radius
- Long Neck Radius
- Taper Neck Radius
- Ball / Long Shank Ball
- Long Neck Ball
- Taper Neck Ball
- Taper
- Spiral V Cutter
- Drill
- EURO Series
- Technical Data

Milling Conditions for CSEB

WORK MATERIAL			COPPER / ALUMINUM ALLOYS				CARBON STEELS / ALLOY STEELS S45C / S50C / SK / SCM (~325HB)				PREHARDENED STEELS NAK80 / STAVAX / HPM38 (30~45HRC)				HARDENED STEELS STAVAX / HPM38 / SKD61 (45~55HRC)			
Model Number	Radius of Ball Nose (mm)	Length of Cut (mm)	Spindle Speed (min ⁻¹)	Feed Rate (mm/min)	a_p Axial Depth (mm)	a_e Radial Depth (mm)	Spindle Speed (min ⁻¹)	Feed Rate (mm/min)	a_p Axial Depth (mm)	a_e Radial Depth (mm)	Spindle Speed (min ⁻¹)	Feed Rate (mm/min)	a_p Axial Depth (mm)	a_e Radial Depth (mm)	Spindle Speed (min ⁻¹)	Feed Rate (mm/min)	a_p Axial Depth (mm)	a_e Radial Depth (mm)
2025-0250 (-6)		2.5	27,000	2,300	0.28	0.75	27,000	2,300	0.25	0.5	27,000	2,300	0.25	0.75	13,000	1,100	0.21	0.63
2025-0375	R1.25	3.75	27,000	2,300	0.28	0.75	27,000	2,300	0.25	0.5	27,000	2,300	0.25	0.75	13,000	1,100	0.21	0.63
2025-0600		6	25,000	2,100	0.26	0.67	25,000	2,100	0.23	0.46	24,000	2,000	0.2	0.65	11,000	930	0.14	0.44
2030-0300		3	24,000	2,500	0.32	0.9	24,000	2,500	0.32	0.9	24,000	2,500	0.3	0.9	14,000	1,400	0.25	0.76
2030-0450	R1.5	4.5	24,000	2,500	0.32	0.9	24,000	2,500	0.32	0.9	24,000	2,500	0.3	0.9	14,000	1,400	0.25	0.76
2030-0800		8	22,000	2,300	0.28	0.7	22,000	2,300	0.28	0.7	20,000	2,000	0.2	0.65	10,700	1,000	0.18	0.54
2035-0520	R1.75	5.2	24,000	2,700	0.35	1	24,000	2,700	0.35	1	21,000	2,400	0.35	1	12,000	1,700	0.3	0.9
2040-0400		4	24,000	2,900	0.4	1.2	24,000	2,900	0.4	1.2	18,000	2,400	0.4	1.2	11,000	2,000	0.34	1
2040-0600 (-4)	R2	6	24,000	2,900	0.4	1.2	24,000	2,900	0.4	1.2	18,000	2,400	0.4	1.2	11,000	2,000	0.34	1
2040-0800		8	24,000	2,900	0.4	1.2	24,000	2,900	0.4	1.2	18,000	2,400	0.4	1.2	11,000	2,000	0.34	1
2045-0670	R2.25	6.7	21,000	3,000	0.45	1.3	21,000	3,000	0.45	1.3	16,000	2,400	0.42	1.2	10,000	1,900	0.38	1.1
2050-0500		5	18,000	3,000	0.5	1.5	18,000	3,000	0.5	1.5	13,000	2,400	0.45	1.4	9,000	1,800	0.42	1.2
2050-0750	R2.5	7.5	18,000	3,000	0.5	1.5	18,000	3,000	0.5	1.5	13,000	2,400	0.45	1.4	9,000	1,800	0.42	1.2
2050-0800		8	18,000	3,000	0.5	1.5	18,000	3,000	0.5	1.5	13,000	2,400	0.45	1.4	9,000	1,800	0.42	1.2
2050-1200		12	18,000	3,000	0.5	1.5	18,000	3,000	0.5	1.5	13,000	2,400	0.45	1.4	9,000	1,800	0.42	1.2
2055-0820	R2.75	8.2	17,000	3,000	0.55	1.6	17,000	3,000	0.55	1.6	12,000	2,400	0.5	1.5	8,500	1,800	0.45	1.3
2060-0600		6	16,000	3,100	0.6	1.8	16,000	3,100	0.6	1.8	11,000	2,310	0.55	1.7	7,500	1,800	0.5	1.5
2060-0900	R3	9	16,000	3,100	0.6	1.8	16,000	3,100	0.6	1.8	11,000	2,310	0.55	1.7	7,500	1,800	0.5	1.5
2060-1200		12	16,000	3,100	0.6	1.8	16,000	3,100	0.6	1.8	11,000	2,310	0.55	1.7	7,500	1,800	0.5	1.5
2065-0970	R3.25	9.7	15,000	3,100	0.65	1.95	15,000	3,100	0.65	1.95	10,000	2,200	0.59	1.8	7,000	1,800	0.54	1.6
2070-1050	R3.5	10.5	14,000	3,200	0.7	2.1	14,000	3,200	0.7	2.1	9,000	2,100	0.63	1.9	6,500	1,800	0.57	1.7
2075-1120	R3.75	11.2	13,000	3,300	0.75	2.25	13,000	3,300	0.75	2.25	8,200	2,000	0.67	2	6,000	1,800	0.6	1.8
2080-0800		8	12,000	3,300	0.8	2.4	12,000	3,300	0.8	2.4	7,400	1,900	0.72	2.2	5,700	1,800	0.65	2
2080-1200	R4	12	12,000	3,300	0.8	2.4	12,000	3,300	0.8	2.4	7,400	1,900	0.72	2.2	5,700	1,800	0.65	2
2080-1400		14	12,000	3,300	0.8	2.4	12,000	3,300	0.8	2.4	7,400	1,900	0.72	2.2	5,700	1,800	0.65	2
2085-1270	R4.25	12.7	12,000	3,300	0.85	2.55	12,000	3,300	0.85	2.55	6,800	1,800	0.75	2.3	5,400	1,700	0.7	2.1
2090-1350	R4.5	13.5	11,000	3,400	0.9	2.7	11,000	3,400	0.9	2.7	6,300	1,700	0.8	2.4	5,100	1,600	0.75	2.2
2100-1000		10	10,000	3,500	1	3	10,000	3,500	1	3	5,200	1,650	0.9	2.7	4,600	1,500	0.85	2.5
2100-1500	R5	15	10,000	3,500	1	3	10,000	3,500	1	3	5,200	1,650	0.9	2.7	4,600	1,500	0.85	2.5
2100-1800		18	10,000	3,500	1	3	10,000	3,500	1	3	5,200	1,650	0.9	2.7	4,600	1,500	0.85	2.5
2110-1650	R5.5	16.5	9,000	3,400	1.1	3.3	9,000	3,400	1.1	3.3	4,700	1,500	1	3	4,200	1,350	0.9	2.7
2120-1200		12	8,400	3,300	1.2	3.6	8,400	3,300	1.2	3.6	4,300	1,350	1.1	3.2	3,800	1,250	1	3
2120-1800	R6	18	8,400	3,300	1.2	3.6	8,400	3,300	1.2	3.6	4,300	1,350	1.1	3.2	3,800	1,250	1	3
2120-2200		22	8,400	3,300	1.2	3.6	8,400	3,300	1.2	3.6	4,300	1,350	1.1	3.2	3,800	1,250	1	3

Note:

- Decrease the feed rate more than 50% from the milling parameters when slot milling.
- Decrease both spindle speed and feed rate proportionally when the milling parameters exceed the machines maximum speed, or when the tool is chattering and heats up to a red color.
- Recommend oil coolant for Stainless Steels and Heat Resistant Alloys.
- Recommend wet coolant for Copper.

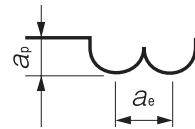

a_p : Axial Depth (mm)
 a_e : Radial Depth (mm)

UDC Series

CBN Series

Square

Long Neck Square

Radius

Long Neck Radius

Taper Neck Radius

Ball / Long Shank Ball

Long Neck Ball

Taper Neck Ball

Taper

Spiral V Cutter

Drill

EURO Series

Technical Data

Milling Example: STAVAX (52HRC) Roughing

◆ Contribution of Helix Ball & Small Relief CSEB 2010-0150

CSEB

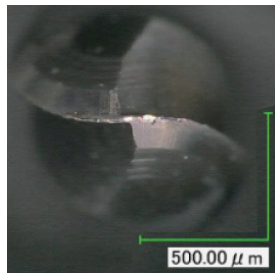

Competitor

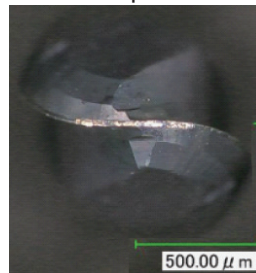

Tool Overhang: 15 mm	Spindle Speed: 30,000 min ⁻¹
Feed Rate: 666 mm/min	Axial Depth: 0.05 mm
Radial Depth: 0.21 mm	Coolant: Air Blow (Nozzle)
Cycle Time: 30 min	Pocket Size: 20 × 20 × 0.5 mm

Milling Example: STAVAX (30HRC) Roughing

◆ Contribution of Helix Ball & Small Relief CSEB 2060-0900

CSEB

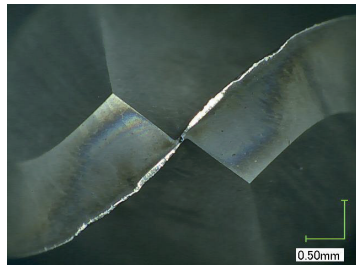

Competitor

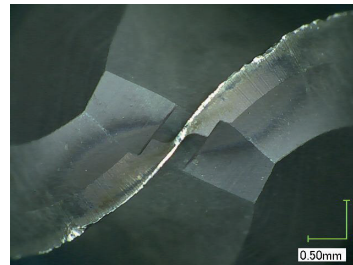

Tool Overhang: 23 mm	Spindle Speed: 16,000 min ⁻¹
Feed Rate: 3,380 mm/min	Axial Depth: 0.6 mm
Radial Depth: 1.8 mm	Coolant: Water Soluble (Nozzle)
Cycle Time: 120 min	Milling Shape: Tapered Circle x 40 pockets
Pocket Size: R12 mm (top) x Depth 17 mm (Pocket tapered angle: 10°)	

* Refer to page 579 for tool geometry.

Milling Example: HPM38 (53HRC) Plastic Mold

◆ Optimized Ball Tip Effect

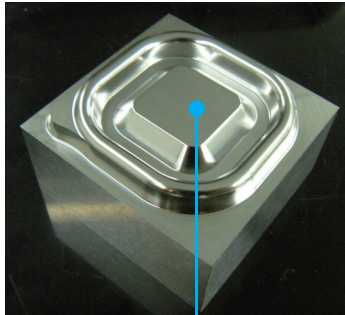

CSEB 2040-0600

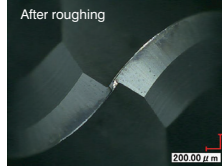

CSEB 2020-0300

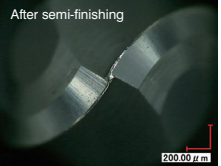

CSEB 2010-0150

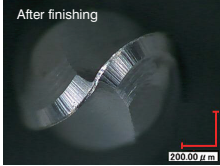

Work Size
50 mm × 50 mm × 30 mm

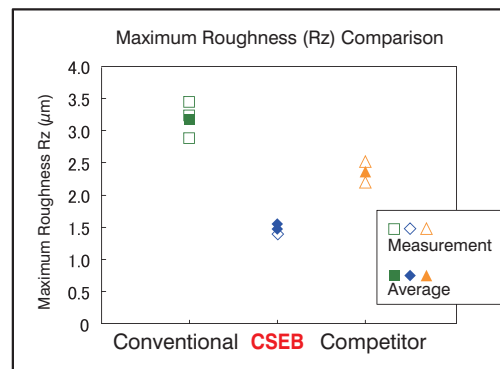
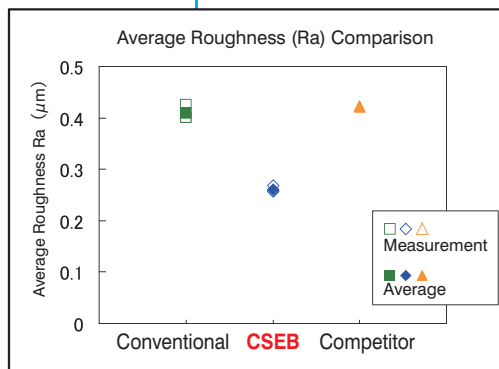

Optimized ball tip offers outstandingly nano-smooth surface on finishing.

No	Milling Process	Tool (Radius of Ball Nose × Length of Cut)	Spindle Speed (min ⁻¹)	Feed Rate (mm/min)	Axial Depth a_p (mm)	Radial Depth a_e (mm)	Overhang Length (mm)	Cycle Time (min)	Coolant
1	Roughing	CSEB 2040-0600 (R2×6)	11,000	2,000	0.34	1	15	0:31:21	Air Blow
2	Semi-finishing	CSEB 2020-0300 (R1×3)	16,000	1,300	0.17	0.5	13	0:03:10	Air Blow
3			16,000	1,300	0.1	0.1	13	0:16:47	Air Blow
4			16,000	1,300	0.01	0.1	13	0:37:00	Oil Mist
5	Finishing	CSEB 2010-0150 (R0.5×1.5)	22,000	1,300	0.04	0.18	12	0:05:06	Oil Mist
6			22,000	700	0.05	0.05	12	0:59:36	Oil Mist
7			22,000	700	0.01	0.05	12	0:30:43	Oil Mist

UDC Series

CBN Series

Square

Square
Long Neck Square

Radius

Radius
Long Neck RadiusRadius
Taper Neck Radius

Ball / Long Shank Ball

Ball
Long Neck BallBall
Taper Neck BallTaper
TaperSpiral
V Cutter

Drill

EURO Series

Technical Data



Size R0.5~R6

DCB



Material Applications (☆ Highly Recommended ○ Recommended ○ Suggested)

Work Material															
Carbon Steels S45C S55C	Alloy Steels SK / SCM SUS	Prehardened Steels NAK HPM	Hardened Steels			Cast Iron	Aluminum Alloys	Graphite	Copper	Plastics	Glass Filled Plastics	Titanium Alloys	Heat Resistant Alloys	Cemented Carbide	Hard Brittle (Non-Metallic) Materials
			~55HRC	~60HRC	~70HRC										
							○	☆	○	○	◎				○

Features

Diamond coated 2 Flute Ball End Mills for Graphite Electrodes.

New diamond coating, with a highly adhesive base layer, offers excellent wear resistance and longer tool life.

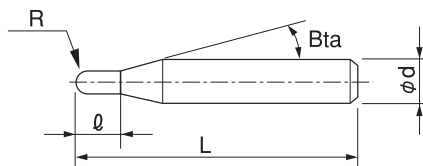

The shank taper angle shown is not an exact value and to avoid contact with the work piece, we recommend the user controls the precise value of this angle. Shank taper angle should not make contact with the work piece.

Total 9 models

Unit (mm)

Model Number	Radius of Ball Nose R	Length of Cut ℓ	Shank Taper Angle Bta	Overall Length L	Shank Diameter φd	Price ¥
DCB 2010	R0.5	5	16°	60	4	16,000
DCB 2020	R1	10	16°	70	4	17,000
DCB 2030	R1.5	15	16°	80	4	21,000
DCB 2040	R2	20	—	100	4	24,000
DCB 2050	R2.5	20	—	100	5	28,000
DCB 2060	R3	30	—	150	6	41,500
DCB 2080	R4	40	—	150	8	45,000
DCB 2100	R5	50	—	180	10	57,500
DCB 2120	R6	55	—	180	12	87,500

Milling Conditions for DCB

WORK MATERIAL		GRAPHITE			
Model Number	Radius of Ball Nose (mm)	Spindle Speed (min ⁻¹)	Feed Rate (mm/min)	a_p Axial Depth (mm)	a_e Radial Depth (mm)
2010	R0.5	10,000	140	0.1	0.3
2020	R1	10,000	300	0.2	0.6
2030	R1.5	10,000	900	0.3	0.9
2040	R2	10,000	900	0.4	1.2
2050	R2.5	10,000	1,200	0.5	1.5
2060	R3	10,000	1,460	0.6	1.8
2080	R4	7,500	1,350	0.8	2.4
2100	R5	6,000	1,440	1	3
2120	R6	5,000	1,400	1.2	3.6

◆ High speed milling

WORK MATERIAL		GRAPHITE			
Model Number	Radius of Ball Nose (mm)	Spindle Speed (min ⁻¹)	Feed Rate (mm/min)	a_p Axial Depth (mm)	a_e Radial Depth (mm)
2010	R0.5	50,000	700	0.1	0.3
2020	R1	45,000	1,350	0.2	0.6
2030	R1.5	30,000	2,700	0.3	0.9
2040	R2	22,500	2,025	0.4	1.2
2050	R2.5	18,000	2,160	0.5	1.5
2060	R3	15,000	2,190	0.6	1.8
2080	R4	11,500	2,300	0.8	2.4
2100	R5	9,000	2,340	1	3
2120	R6	7,500	2,250	1.2	3.6

Note:

- Use a milling machine dedicated for Graphite.
- Recommend air blow for Graphite.

For 3D milling / Finishing
Milling Amount (mm)

a_p : Axial Depth (mm)

a_e : Radial Depth (mm)

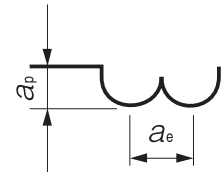

DCB Series
Aluminum:A7075
Milling Video



DCB Series
Graphite:TTK-5(80HS)
Milling Video



UDC Series

CBN Series

Square

Long Neck Square

Radius

Long Neck Radius

Taper Neck Radius

Ball / Long Shank Ball

Long Neck Ball

Taper Neck Ball

Taper

Spiral V Cutter

Drill

EURO Series

Technical Data



Size R0.2~R6

CGB2000



Material Applications (☆ Highly Recommended ● Recommended ○ Suggested)

Work Material															
Carbon Steels S45C S55C	Alloy Steels SK / SCM SUS	Prehardened Steels NAK HPM	Hardened Steels			Cast Iron	Aluminum Alloys	Graphite	Copper	Plastics	Glass Filled Plastics	Titanium Alloys	Heat Resistant Alloys	Cemented Carbide	Hard Brittle (Non-Metallic) Materials
			~55HRC	~60HRC	~70HRC										
							○	☆	○	○	○				

Features

Designed for milling Graphite.
The chosen carbide grade offers excellent resistance to wear and abrasion.
Refer to page 432 for 4 flute CGB.

The shank taper angle shown is not an exact value and to avoid contact with the work piece, we recommend the user controls the precise value of this angle. Shank taper angle should not make contact with the work piece. Actual measurement is necessary when using longer length of cut than the written length.

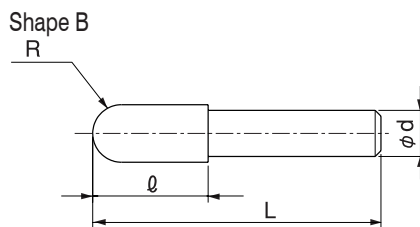
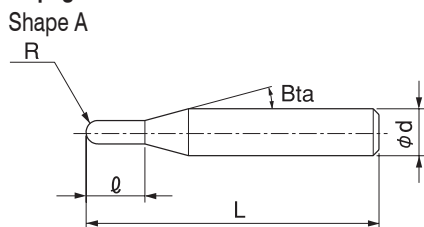

Total 15 models

Unit (mm)

Model Number	Radius of Ball Nose R	Length of Cut ℓ	Shank Taper Angle Bta	Overall Length L	Shank Diameter φd	Shape	Price ¥
CGB 2004	R0.2	0.8	16°	60	4	A	11,000
CGB 2006	R0.3	1.2	16°	60	4	A	11,000
CGB 2010	R0.5	5	16°	60	4	A	11,000
CGB 2015	R0.75	5	16°	60	4	A	11,000
CGB 2020	R1	10	16°	70	4	A	12,700
CGB 2025	R1.25	10	16°	70	4	A	12,700
CGB 2030	R1.5	15	16°	80	4	A	15,600
CGB 2040	R2	20	—	100	4	A	18,600
CGB 2050	R2.5	20	—	100	5	A	18,900
CGB 2060	R3	30	—	150	6	A	21,420
CGB 2070	R3.5	30	—	150	6	B	24,050
CGB 2080	R4	40	—	150	8	A	27,170
CGB 2100	R5	50	—	180	10	A	35,420
CGB 2110	R5.5	50	—	180	10	B	38,060
CGB 2120	R6	55	—	200	12	A	41,470

Milling Conditions for CGB (2 Flutes)

WORK MATERIAL		GRAPHITE			
Model Number	Radius of Ball Nose (mm)	Spindle Speed (min ⁻¹)	Feed Rate (mm/min)	a_p Axial Depth (mm)	a_e Radial Depth (mm)
2004	R0.2	15,000	60~90	0.12	0.28
2006	R0.3	15,000	90~130	0.18	0.42
2010	R0.5	15,000	150~220	0.3	0.7
2015	R0.75	15,000	240~360	0.45	1.05
2020	R1	15,000	300~450	0.6	1.4
2025	R1.25	15,000	550~800	0.75	1.75
2030	R1.5	15,000	900~1,350	0.9	2.1
2040	R2	15,000	900~1,350	1.2	2.8
2050	R2.5	15,000	1,200~1,800	1.5	3.5
2060	R3	15,000	1,500~2,200	1.8	4.2
2070	R3.5	9,100	1,500~2,200	2.1	4.9
2080	R4	8,000	1,500~2,200	2.4	5.6
2100	R5	6,500	1,500~2,200	3	7
2110	R5.5	6,000	1,500~2,200	3.3	7.7
2120	R6	5,300	1,500~2,200	3.6	8.4

For 3D milling / Finishing
Milling Amount (mm)

$$a_p = 0.3D$$

$$a_e = 0.7D$$

a_p : Axial Depth (mm)

a_e : Radial Depth (mm)

D : Outside Diameter (mm)

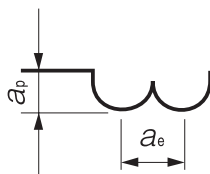

Note:

- Use a milling machine dedicated for Graphite.
- Recommend air blow for Graphite.

UDC Series

CBN Series

Square

Long Neck Square

Radius

Long Neck Radius

Taper Neck Radius

Ball / Long Shank Ball

Long Neck Ball

Taper Neck Ball

Taper

Spiral V Cutter

Drill

EURO Series

Technical Data



Size R0.3~R6

CFB

Super
MG

UT
COAT

30°

R
±0.005
R0.3~R1.5

R
±0.007
R2~R3

R
±0.01
R4~R6

Shank Dia
0/-0.005

Variable
Pitch

Material Applications (☆ Highly Recommended ○ Recommended ○ Suggested)

Work Material															
Carbon Steels S45C S55C	Alloy Steels SK / SCM SUS	Prehardened Steels NAK HPM	Hardened Steels			Cast Iron	Aluminum Alloys	Graphite	Copper	Plastics	Glass Filled Plastics	Titanium Alloys	Heat Resistant Alloys	Cemented Carbide	Hard Brittle (Non-Metallic) Materials
			~55HRC	~60HRC	~70HRC										
○	○	○	○			○	○		○	○		○	○		

Features

3 flute design offers high feed milling, reducing cycle times when roughing.
Capable of deep milling that raises machine efficiency, even with complicated shapes that require slow feeds. Variable pitch design minimizes tool chattering.
Broad range of applications from Copper and Raw Materials to Hardened Steels (55HRC).
The original design features help to promote excellent chip evacuation and surface finishing on tools over R0.75 mm.
Diameter Tolerance: 0/-0.02

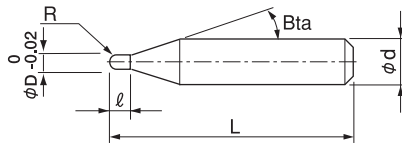
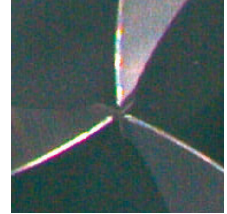

The shank taper angle shown is not an exact value and to avoid contact with the work piece, we recommend the user controls the precise value of this angle. Shank taper angle should not make contact with the work piece.

Total 14 models

Unit (mm)

Model Number	Radius of Ball Nose R	Length of Cut ℓ	Shank Taper Angle Bta	Overall Length L	Shank Diameter ød	Price ¥
CFB 3006-0090	R0.3	0.9	16°	50	4	6,890
CFB 3008-0120	R0.4	1.2	16°	50	4	6,720
CFB 3010-0150	R0.5	1.5	16°	50	4	6,230
CFB 3015-0225	R0.75	2.25	16°	50	4	6,890
CFB 3020-0300	R1	3	16°	50	4	6,720
CFB 3030-0450	R1.5	4.5	16°	60	6	6,890
CFB 3040-0600-4	R2	6	—	70	4	6,560
CFB 3040-0600			16°	70	6	6,890
CFB 3050-0750	R2.5	7.5	16°	80	6	7,790
CFB 3060-0900	R3	9	—	80	6	8,610
CFB 3080-1200	R4	12	—	90	8	12,300
CFB 3080-1200LS				120	8	13,940
CFB 3100-1500	R5	15	—	100	10	16,320
CFB 3120-1800	R6	18	—	110	12	20,660

Milling Conditions for CFB

◆Roughing

WORK MATERIAL		COPPER / ALUMINUM ALLOYS C1100 / A5052 / A7075 (~225HB)				ALLOY STEELS / PREHARDENED STEELS S45C / S50C / SKD / NAK (~45HRC)				HARDENED STEELS STAVAX / SKD61 (45~55HRC)			
Coolant		DRY (Unsuitable for Aluminum Alloys) / WET				DRY / WET				DRY			
Model Number	Radius of Ball Nose (mm)	Spindle Speed (min ⁻¹)	Feed Rate (mm/min)	a_p Axial Depth (mm)	a_e Radial Depth (mm)	Spindle Speed (min ⁻¹)	Feed Rate (mm/min)	a_p Axial Depth (mm)	a_e Radial Depth (mm)	Spindle Speed (min ⁻¹)	Feed Rate (mm/min)	a_p Axial Depth (mm)	a_e Radial Depth (mm)
3006-0090	R0.3	30,000	1,000	0.03	0.13	30,000	1,000	0.03	0.13	30,000	700	0.03	0.13
3008-0120	R0.4	30,000	1,250	0.04	0.17	30,000	1,250	0.04	0.17	30,000	850	0.04	0.17
3010-0150	R0.5	30,000	1,500	0.05	0.21	30,000	1,500	0.05	0.21	30,000	1,000	0.05	0.21
3015-0225	R0.75	30,000	2,500	0.075	0.32	30,000	2,500	0.075	0.32	30,000	1,700	0.075	0.32
3020-0300	R1	30,000	3,200	0.2	0.6	30,000	3,200	0.2	0.6	30,000	2,500	0.2	0.6
3030-0450	R1.5	24,000	4,000	0.3	0.9	24,000	4,000	0.3	0.9	21,600	2,700	0.3	0.9
3040-0600	R2	18,000	4,000	0.4	1.2	18,000	4,000	0.4	1.2	16,200	2,700	0.4	1.2
3050-0750	R2.5	15,000	4,000	0.5	1.5	15,000	4,000	0.5	1.5	13,500	2,700	0.5	1.5
3060-0900	R3	12,000	4,000	0.6	1.8	12,000	4,000	0.6	1.8	10,800	2,700	0.6	1.8
3080-1200(LS)	R4	9,000	4,000	0.8	2.4	9,000	4,000	0.8	2.4	8,100	2,700	0.75	2.1
3100-1500	R5	7,200	4,000	1	3	7,200	4,000	1	3	6,500	2,700	0.85	2.5
3120-1800	R6	6,000	4,000	1.2	3.6	6,000	4,000	1.2	3.6	5,400	2,700	0.95	3

WORK MATERIAL		TITANIUM ALLOYS / STAINLESS STEELS Ti-6Al-4V / SUS				HEAT RESISTANT ALLOYS Inconel718			
Coolant		DRY (Unsuitable for Aluminum Alloys) / WET				WET			
Model Number	Radius of Ball Nose (mm)	Spindle Speed (min ⁻¹)	Feed Rate (mm/min)	a_p Axial Depth (mm)	a_e Radial Depth (mm)	Spindle Speed (min ⁻¹)	Feed Rate (mm/min)	a_p Axial Depth (mm)	a_e Radial Depth (mm)
3006-0090	R0.3	20,000	1,000	0.015	0.09	10,000	250	0.015	0.09
3008-0120	R0.4	20,000	1,250	0.02	0.12	10,000	310	0.02	0.12
3010-0150	R0.5	20,000	1,500	0.025	0.15	10,000	375	0.025	0.15
3015-0225	R0.75	20,000	2,500	0.035	0.22	10,000	625	0.035	0.22
3020-0300	R1	24,000	4,000	0.1	0.4	12,000	1,000	0.1	0.4
3030-0450	R1.5	16,000	4,000	0.15	0.65	8,000	1,000	0.15	0.65
3040-0600	R2	12,000	4,000	0.2	0.85	6,000	1,000	0.2	0.85
3050-0750	R2.5	10,000	4,000	0.25	1	5,000	1,000	0.25	1
3060-0900	R3	8,000	4,000	0.3	1.3	4,000	1,000	0.3	1.3
3080-1200(LS)	R4	6,000	4,000	0.4	1.7	3,000	900	0.35	1.6
3100-1500	R5	4,800	4,000	0.5	2.1	2,400	800	0.4	1.9
3120-1800	R6	4,000	4,000	0.6	2.6	2,000	800	0.45	2.2

Apply when a deep tool setting causes the toolholder to extend beyond the full shank diameter and over the taper angle.
Use the table below to adjust the parameters when compensating for extended overhang on the straight type design.

WORK MATERIAL	COPPER / CARBON STEELS / ALUMINUM ALLOYS S45C, S50C, A5052, A7075 (~225HB)				ALLOY STEELS / PREHARDENED STEELS SKD / NAK (~45HRC)				HARDENED STEELS STAVAX / SKD61 (45~55HRC)			
Overhang Length	Spindle Speed	Feed Rate	a_p Axial Depth	a_e Radial Depth	Spindle Speed	Feed Rate	a_p Axial Depth	a_e Radial Depth	Spindle Speed	Feed Rate	a_p Axial Depth	a_e Radial Depth
~3D	×1	×1~1.5(※)	×1	×1	×1	×1	×1	×1	×1	×1	×1	×1
4D	×0.9	×0.9~1.2(※)	×1	×1	×0.9	×0.9	×1	×1	×0.9	×0.9	×1	×1
5D	×0.75	×0.75	×1	×1	×0.75	×0.75	×0.9	×0.9	×0.75	×0.75	×0.85	×0.9
6D	×0.6	×0.6	×1	×1	×0.6	×0.6	×0.85	×0.9	×0.6	×0.6	×0.8	×0.85
7D	×0.45	×0.4	×0.95	×0.95	×0.45	×0.4	×0.8	×0.85	×0.45	×0.4	×0.7	×0.8
8D	×0.35	×0.3	×0.9	×0.9	×0.35	×0.3	×0.7	×0.8	×0.35	×0.3	×0.6	×0.75

WORK MATERIAL	TITANIUM ALLOYS / STAINLESS STEELS Ti-6Al-4V / SUS				HEAT RESISTANT ALLOYS Inconel718			
Overhang Length	Spindle Speed	Feed Rate	a_p Axial Depth	a_e Radial Depth	Spindle Speed	Feed Rate	a_p Axial Depth	a_e Radial Depth
~3D	×1	×1	×1	×1	×1	×1	×1	×1
4D	×0.9	×0.9	×1	×1	×0.9	×0.9	×1	×1
5D	×0.75	×0.75	×0.95	×0.95	×0.75	×0.75	×0.85	×0.9
6D	×0.6	×0.6	×0.9	×0.9	×0.6	×0.6	×0.8	×0.85
7D	×0.45	×0.4	×0.85	×0.9	×0.45	×0.4	×0.7	×0.8
8D	×0.35	×0.3	×0.85	×0.85	×0.35	×0.3	×0.6	×0.75

(※) For high efficiency milling, set the feed rate higher. For improved surface finish and/or longer tool life, reduce the feed rate.

UDC Series

CBN Series

Square

Long Neck Square

Radius

Long Neck Radius

Taper Neck Radius

Ball / Long Shank Ball

Long Neck Ball

Taper Neck Ball

Taper

Spiral V Cutter

Drill

EURO Series

Technical Data

Milling Conditions for CFB

◆Finishing (overhang length ~6D)

WORK MATERIAL		COPPER / CARBON STEELS / ALUMINUM ALLOYS S45C / S50C / A5052 / A7075 (~225HB)				ALLOY STEELS / HARDENED STEELS SKD / NAK (~45HRC)				HARDENED STEELS STAVAX / SKD61 (45~55HRC)			
Coolant		WET				DRY / OIL MIST / WET				DRY / OIL MIST			
Model Number	Radius of Ball Nose (mm)	Spindle Speed (min ⁻¹)	Feed Rate (mm/min)	a _p Axial Depth (mm)	a _e Radial Depth (mm)	Spindle Speed (min ⁻¹)	Feed Rate (mm/min)	a _p Axial Depth (mm)	a _e Radial Depth (mm)	Spindle Speed (min ⁻¹)	Feed Rate (mm/min)	a _p Axial Depth (mm)	a _e Radial Depth (mm)
3020-0300	R1	53,000	4,000	0.05	0.04	45,000	3,400	0.05	0.04	36,800	2,200	0.05	0.04
3030-0450	R1.5	41,200	4,200	0.06	0.06	35,000	3,500	0.06	0.06	28,600	2,300	0.06	0.06
3040-0600	R2	29,400	4,400	0.08	0.08	24,000	3,700	0.08	0.08	20,400	2,400	0.08	0.08
3060-0900	R3	17,600	4,600	0.1	0.12	14,000	3,900	0.1	0.12	12,300	2,600	0.1	0.12
3080-1200	R4	14,600	4,600	0.1	0.16	12,400	3,900	0.1	0.16	10,200	2,600	0.1	0.16
3100-1500	R5	11,700	4,700	0.1	0.2	9,900	4,000	0.1	0.2	8,200	2,600	0.1	0.2
3120-1800	R6	8,800	4,800	0.1	0.24	7,400	4,000	0.1	0.24	6,200	2,700	0.1	0.24

WORK MATERIAL		TITANIUM ALLOYS / STAINLESS STEELS Ti-6Al-4V / SUS				HEAT RESISTANT ALLOYS Inconel718			
Coolant		WET				WET			
Model Number	Radius of Ball Nose (mm)	Spindle Speed (min ⁻¹)	Feed Rate (mm/min)	a _p Axial Depth (mm)	a _e Radial Depth (mm)	Spindle Speed (min ⁻¹)	Feed Rate (mm/min)	a _p Axial Depth (mm)	a _e Radial Depth (mm)
3020-0300	R1	44,200	2,700	0.05	0.04	22,100	1,100	0.05	0.04
3030-0450	R1.5	34,400	2,800	0.06	0.06	17,200	1,100	0.06	0.06
3040-0600	R2	24,600	3,000	0.08	0.08	12,300	1,200	0.08	0.08
3060-0900	R3	14,800	3,200	0.1	0.12	7,400	1,300	0.1	0.12
3080-1200	R4	12,300	3,200	0.1	0.16	6,200	1,300	0.1	0.16
3100-1500	R5	9,900	3,200	0.1	0.2	5,000	1,300	0.1	0.2
3120-1800	R6	7,500	3,300	0.1	0.24	3,800	1,400	0.1	0.24

*When finishing with an overhang of over 6 x D, fine adjustments are recommended.

UDC Series

CBN Series

Square

Long Neck Square

Radius

Long Neck Radius

Taper Neck Radius

Ball / Long Shank Ball

Long Neck Ball

Taper Neck Ball

Taper

Spiral V Cutter

Drill

EURO Series

Technical Data

Milling Conditions for CFB

◆ Deep and high efficiency roughing (3xD overhang for straight type)

This parameter is effective in using the machine that has low acceleration and applying complex milling path that repeats accelerating/braking frequently.

WORK MATERIAL		COPPER / CARBON STEELS / ALUMINUM ALLOYS S45C / S50C / A5052 / A7075 (~225HB)				ALLOY STEELS / HARDENED STEELS SKD / NAK (~45HRC)			
Coolant		DRY (Unsuitable for Aluminum Alloys) / WET				DRY / WET			
Model Number	Radius of Ball Nose (mm)	Spindle Speed (min ⁻¹)	Feed Rate (mm/min)	a_p Axial Depth (mm)	a_e Radial Depth (mm)	Spindle Speed (min ⁻¹)	Feed Rate (mm/min)	a_p Axial Depth (mm)	a_e Radial Depth (mm)
3020-0300	R1	30,000	2,500	0.4	0.8	30,000	2,500	0.4	0.8
3030-0450	R1.5	20,000	2,500	0.6	1.2	20,000	2,500	0.6	1.2
3040-0600	R2	15,000	2,500	0.8	1.6	15,000	2,500	0.8	1.6
3060-0900	R3	10,000	2,500	1.2	2.4	10,000	2,500	1.2	2.4
3080-1200	R4	7,100	2,350	1.6	3.2	7,100	2,350	1.6	3.2
3100-1500	R5	5,400	2,250	2	4	5,400	2,250	2	4
3120-1800	R6	4,500	2,250	2.4	4.8	4,500	2,250	2.4	4.8

WORK MATERIAL		HARDENED STEELS STAVAX / SKD61 (45~55HRC)				TITANIUM ALLOYS / STAINLESS STEELS Ti-6Al-4V / SUS			
Coolant		DRY				WET			
Model Number	Radius of Ball Nose (mm)	Spindle Speed (min ⁻¹)	Feed Rate (mm/min)	a_p Axial Depth (mm)	a_e Radial Depth (mm)	Spindle Speed (min ⁻¹)	Feed Rate (mm/min)	a_p Axial Depth (mm)	a_e Radial Depth (mm)
3020-0300	R1	24,000	1,500	0.4	0.8	19,200	2,000	0.2	0.6
3030-0450	R1.5	16,000	1,500	0.6	1.2	12,800	2,000	0.3	0.9
3040-0600	R2	12,000	1,500	0.8	1.6	9,600	2,000	0.4	1.2
3060-0900	R3	8,000	1,500	1.2	2.4	6,400	2,000	0.6	1.8
3080-1200	R4	5,600	1,400	1.5	3	4,800	2,000	0.8	2.4
3100-1500	R5	4,300	1,300	1.7	3.5	3,900	2,000	1	3
3120-1800	R6	3,550	1,300	1.9	4.2	3,200	2,000	1.2	3.6

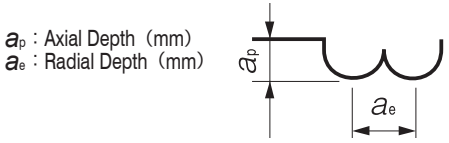

- Note:
- Fix the work piece firmly, and use a machine that has high rigidity and generates a low level of vibration especially under high efficient deep milling condition in roughing process.
 - Decrease the feed rate more than 50% from the milling parameters when slot milling.
 - Decrease both spindle speed and feed rate proportionally when the milling parameters exceed the machines maximum speed, or when the tool is chattering and heats up to a red color.
 - Decrease both spindle speed and feed rate 10% for slope milling.
 - Decrease both spindle speed and feed rate to meet required precision and to prevent the shank making contact with the work piece.
 - DRY: air blow, WET: water soluble or oil coolant.
 - A long overhang may cause tool deflection, leaving uncut material.

CFB Series
SKD61 (47HRC)
Milling Video



UDC Series

CBN Series

Square
Long Neck Square

Radius

Long Neck Radius

Taper Neck Radius

Ball / Long Shank Ball

Long Neck Ball

Taper Neck Ball

Taper

Spiral V Cutter

Drill

EURO Series

Technical Data

CFB combines roughing and finishing all in one tool.

Milling Example: Wear Comparison

Work Material: S50C Annealed Materials
 Tool: CFB 3060-0900 (R3, Length of Cut 9 mm)
 Competitor's 3 Flute Ball (R3, Length of Cut 9 mm)

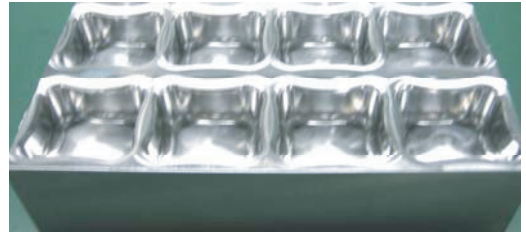

	Roughing	Semi-finishing	Finishing
Spindle Speed	12,000 min ⁻¹	12,000 min ⁻¹	30,000 min ⁻¹
Feed Rate	6,000 mm/min	6,000 mm/min	4,000 mm/min
Axial Depth a_p	0.6 mm	0.7 mm	0.12 mm
Radial Depth a_e	3 mm	0.7 mm	0.12 mm
Cycle Time	5 min	2 min	17 min
Coolant	Air Blow		
Pocket Size	55 mm x 50 mm x Depth 23 mm		
Cycle Time/Pocket	24 min/pocket (4 pockets: 96 min)		

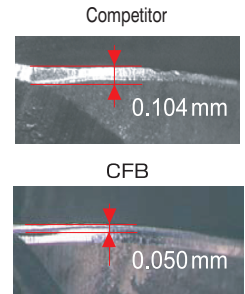
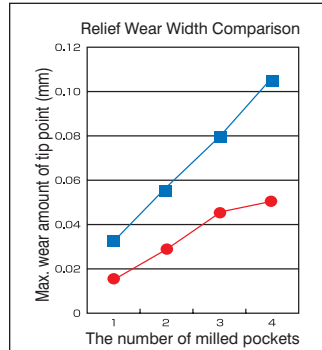

Relief Wear Width CFB : 0.050 mm
 Competitor : 0.104 mm **2 x More Tool Life!**

Milling Example: Acrylic Milling

Work Material: Acrylic
 Tool: CFB 3060-0900 (R3, Length of Cut 9 mm)

	Roughing	Semi-finishing	Finishing
Spindle Speed	12,000 min ⁻¹	12,000 min ⁻¹	30,000 min ⁻¹
Feed Rate	6,000 mm/min	6,000 mm/min	4,000 mm/min
Axial Depth a_p	0.6 mm	0.7 mm	0.12 mm
Radial Depth a_e	3.0 mm	0.7 mm	0.12 mm
Cycle Time	5 min	2 min	17 min
Coolant	Water Soluble		
Pocket Size	55 mm x 50 mm x Depth 23 mm		
Cycle Time	24 min		

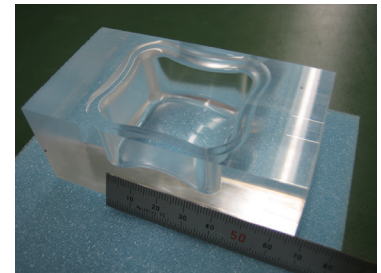

Mirror Surface Finish! Outstanding Transparency!

UDC Series

CBN Series

Square

Square

Long Neck Square

Radius

Radius

Long Neck Radius

Taper Neck Radius

Ball

Ball / Long Shank Ball

Long Neck Ball

Taper Neck Ball

Taper

Taper

Spiral V Cutter

Drill

EURO Series

Technical Data



Size R0.3~R6

DLC-CFB



R0.3~R1.5

R2~R3

R4~R6

Material Applications (☆ Highly Recommended ● Recommended ○ Suggested)

Work Material															
Carbon Steels S45C S55C	Alloy Steels SK / SCM SUS	Prehardened Steels NAK HPM	Hardened Steels			Cast Iron	Aluminum Alloys	Graphite	Copper	Plastics	Glass Filled Plastics	Titanium Alloys	Heat Resistant Alloys	Cemented Carbide	Hard Brittle (Non-Metallic) Materials
			~55HRC	~60HRC	~70HRC										
							☆		○	○					

Features

Achieves dramatically higher feed rates with 3 flutes, shortening roughing time.

DLC coating offers excellent welding and wear resistance.

Offers highly efficient milling even for a slow-moving shape, with deep cut milling.

3 flute variable pitch design reduces chattering.

The 3 slots at the tip offers chip evacuation and improved surface finish. (Except R0.75 or below)

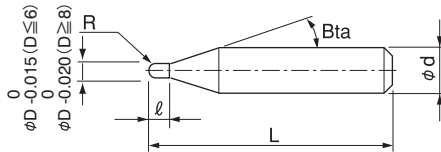
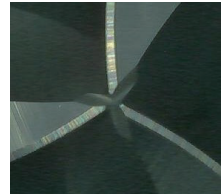

The shank taper angle shown is not an exact value and to avoid contact with the work piece, we recommend the user controls the precise value of this angle. Shank taper angle should not make contact with the work piece.

Total 14 models

Unit (mm)

Model Number	Radius of Ball Nose R	Length of Cut ℓ	Shank Taper Angle Bta	Overall Length L	Shank Diameter ϕd	Price ¥
DLC-CFB 3006-0090	R0.3	0.9	16°	50	4	7,220
DLC-CFB 3008-0120	R0.4	1.2	16°	50	4	7,040
DLC-CFB 3010-0150	R0.5	1.5	16°	50	4	6,540
DLC-CFB 3015-0225	R0.75	2.25	16°	50	4	7,220
DLC-CFB 3020-0300	R1	3	16°	50	4	7,040
DLC-CFB 3030-0450	R1.5	4.5	16°	60	6	7,220
DLC-CFB 3040-0600-4	R2	6	—	70	4	6,880
DLC-CFB 3040-0600			16°	70	6	7,220
DLC-CFB 3050-0750	R2.5	7.5	16°	80	6	8,170
DLC-CFB 3060-0900	R3	9	—	80	6	9,030
DLC-CFB 3080-1200	R4	12	—	90	8	12,900
DLC-CFB 3080-1200LS				120	8	14,600
DLC-CFB 3100-1500	R5	15	—	100	10	17,100
DLC-CFB 3120-1800	R6	18	—	110	12	21,600

Milling Conditions for DLC-CFB

◆Roughing

WORK MATERIAL		ALUMINUM ALLOYS A5052 etc.				ALUMINUM ALLOYS A7075 etc.			
Model Number	Radius of Ball Nose (mm)	Spindle Speed (min ⁻¹)	Feed Rate (mm/min)	a_p Axial Depth (mm)	a_e Radial Depth (mm)	Spindle Speed (min ⁻¹)	Feed Rate (mm/min)	a_p Axial Depth (mm)	a_e Radial Depth (mm)
3006-0090	R0.3	30,000	1,200	0.03	0.13	30,000	1,000	0.03	0.13
3008-0120	R0.4	30,000	1,500	0.04	0.17	30,000	1,250	0.04	0.17
3010-0150	R0.5	30,000	1,800	0.05	0.21	30,000	1,500	0.05	0.21
3015-0225	R0.75	30,000	3,000	0.075	0.32	30,000	2,500	0.075	0.32
3020-0300	R1	30,000	3,840	0.2	0.6	30,000	3,200	0.2	0.6
3030-0450	R1.5	24,000	4,800	0.3	0.9	24,000	4,000	0.3	0.9
3040-0600(-4)	R2	18,000	4,800	0.4	1.2	18,000	4,000	0.4	1.2
3050-0750	R2.5	15,000	4,800	0.5	1.5	15,000	4,000	0.5	1.5
3060-0900	R3	12,000	4,800	0.6	1.8	12,000	4,000	0.6	1.8
3080-1200(LS)	R4	9,000	4,800	0.8	2.4	9,000	4,000	0.8	2.4
3100-1500	R5	7,200	4,800	1	3	7,200	4,000	1	3
3120-1800	R6	6,000	4,800	1.2	3.6	6,000	4,000	1.2	3.6

Apply when a deep tool setting causes the tool holder to extend beyond the full shank diameter and over the taper angle.
Use the table below to adjust the parameters when compensating for extended overhang on the straight type design.

WORK MATERIAL	ALUMINUM ALLOYS A5052, A7075			
Overhang Length	Spindle Speed	Feed Rate	a_p Axial Depth	a_e Radial Depth
~3D	×1	×1~1.5(※)	×1	×1
4D	×0.9	×0.9~1.2(※)	×1	×1
5D	×0.75	×0.75	×1	×1
6D	×0.6	×0.6	×1	×1
7D	×0.45	×0.4	×0.95	×0.95
8D	×0.35	×0.3	×0.9	×0.9

(※)For high efficiency milling, set the feed rate higher. For improved surface finish and/or longer tool life, reduce the feed rate.

a_p : Axial Depth (mm)
 a_e : Radial Depth (mm)

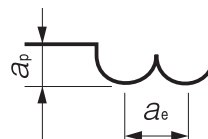

UDC Series

CBN Series

Square

Long Neck Square

Radius

Long Neck Radius

Taper Neck Radius

Ball / Long Shank Ball

Long Neck Ball

Taper Neck Ball

Taper

Spiral V Cutter

Drill

EURO Series

Technical Data

Milling Conditions for DLC-CFB

◆ Finishing (overhang length ~6D)

WORK MATERIAL		ALUMINUM ALLOYS A5052				ALUMINUM ALLOYS A7075			
Model Number	Radius of Ball Nose (mm)	Spindle Speed (min ⁻¹)	Feed Rate (mm/min)	a _p Axial Depth (mm)	a _e Radial Depth (mm)	Spindle Speed (min ⁻¹)	Feed Rate (mm/min)	a _p Axial Depth (mm)	a _e Radial Depth (mm)
3020-0300	R1	53,000	4,800	0.05	0.04	53,000	4,000	0.05	0.04
3030-0450	R1.5	42,100	5,040	0.06	0.06	42,100	4,200	0.06	0.06
3040-0600	R2	29,400	5,280	0.08	0.08	29,400	4,400	0.08	0.08
3060-0900	R3	17,600	5,520	0.1	0.12	17,600	4,600	0.1	0.12
3080-1200	R4	14,600	5,520	0.1	0.2	14,600	4,600	0.1	0.2
3100-1500	R5	11,700	5,640	0.1	0.2	11,700	4,700	0.1	0.2
3120-1800	R6	8,800	5,760	0.1	0.24	8,800	4,800	0.1	0.24

Adjustments are recommended when finishing with an overhang of over 6 x D.

◆ Deep and high efficiency roughing (overhang length ~3D for straight type)

This parameter is effective in using the machine that has low acceleration and applying complex milling path that repeats accelerating/braking frequently.

WORK MATERIAL		ALUMINUM ALLOYS A5052				ALUMINUM ALLOYS A7075			
Model Number	Radius of Ball Nose (mm)	Spindle Speed (min ⁻¹)	Feed Rate (mm/min)	a _p Axial Depth (mm)	a _e Radial Depth (mm)	Spindle Speed (min ⁻¹)	Feed Rate (mm/min)	a _p Axial Depth (mm)	a _e Radial Depth (mm)
3020-0300	R1	30,000	3,000	0.4	0.8	30,000	2,500	0.4	0.8
3030-0450	R1.5	20,000	3,000	0.6	1.2	20,000	2,500	0.6	1.2
3040-0600	R2	15,000	3,000	0.8	1.6	15,000	2,500	0.8	1.6
3060-0900	R3	10,000	3,000	1.2	2.4	10,000	2,500	1.2	2.4
3080-1200	R4	7,100	2,820	1.6	3.2	7,100	2,350	1.6	3.2
3100-1500	R5	5,400	2,700	2	4	5,400	2,250	2	4
3120-1800	R6	4,500	2,700	2.4	4.8	4,500	2,250	2.4	4.8

Note:

- Fix the work piece firmly, and use a machine that has high rigidity and generates a low level of vibration especially under high efficient deep milling condition in roughing process.
- Decrease the feed rate more than 50% from the milling parameters when slot milling.
- Decrease both spindle speed and feed rate proportionally when the milling parameters exceed the machines maximum speed, or when the tool is chattering and heats up to a red color.
- Decrease both spindle speed and feed rate 10% for slope milling.
- Decrease both spindle speed and feed rate to meet required precision and to prevent the shank making contact with the work piece.
- Recommend water soluble or oil coolant.
- A long overhang may cause tool deflection, leaving uncut material.

Mold Milling Example for Plastic Container
 DLC-CFB R4 × Length of Cut 12

A5052

3 Flutes

Tool after milling

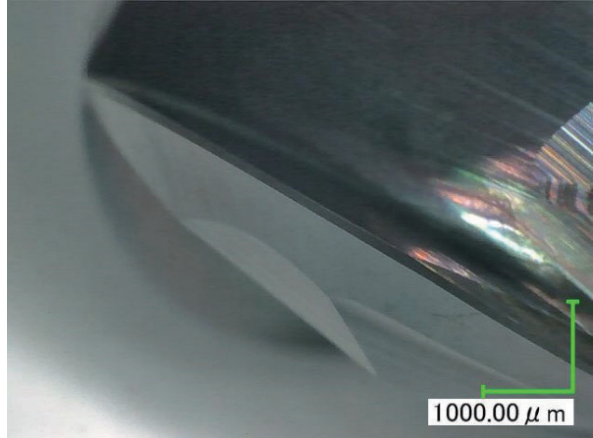

Work Size : 130 x 105 x 95 mm
 Pocket Size : ϕ 80.5 x Depth 25 mm
 Coolant : Water Soluble (Through Spindle)

More tool life left

No.	Milling Process	Tool	Spindle Speed (min ⁻¹)	Feed Rate (mm/min)	a_p Axial Depth (mm)	a_e Radial Depth (mm)	Allowance (mm)	Milling Spot	Cycle Time (h:min)
1	Roughing	DLC-CFB 3080-1200	8,100	4,320	0.8	2.4	0.01	Pocket & Half Pocket	1:05
2	Finishing				0.0001 (Cusp Height)	0.05	0	Pocket	2:58
Total									4:03

- UDC Series
- CBN Series
- Square
- Long Neck Square
- Radius
- Long Neck Radius
- Taper Neck Radius
- Ball / Long Shank Ball
- Long Neck Ball
- Taper Neck Ball
- Taper
- Spiral V Cutter
- Drill
- EURO Series
- Technical Data

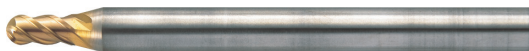

Size R1~R6

HFB

Super
MG

HARD
MAX

40°

R
±0.005
R1~R1.5

R
±0.007
R2~R3

R
±0.01
R4~R6

Shank Dia
0/-0.005

Patented in Japan, China, Korea, Taiwan, Germany, Switzerland, and Liechtenstein

Material Applications (☆ Highly Recommended ○ Recommended ○ Suggested)

Work Material															
Carbon Steels S45C S55C	Alloy Steels SK / SCM SUS	Prehardened Steels NAK HPM	Hardened Steels			Cast Iron	Aluminum Alloys	Graphite	Copper	Plastics	Glass Filled Plastics	Titanium Alloys	Heat Resistant Alloys	Cemented Carbide	Hard Brittle (Non-Metallic) Materials
			~55HRC	~60HRC	~70HRC										
			○	○	○										

Features

Dramatically improved the milling efficiency. Maximum 27 times higher chip evacuation compared to conventional tool.
 New ball tip design offers polish-less bottom surface finishing.
 Affordable pricing.
 Diameter Tolerance: 0/-0.02

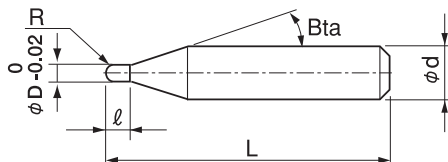

The shank taper angle shown is not an exact value and to avoid contact with the work piece, we recommend the user controls the precise value of this angle. Shank taper angle should not make contact with the work piece.

Total 8 models

Unit (mm)

Model Number	Radius of Ball Nose R	Length of Cut ℓ	Shank Taper Angle Bta	Overall Length L	Shank Diameter φd	Price ¥
HFB 4020-0300	R1	3	16°	50	4	6,720
HFB 4020-0300-6	R1	3	16°	50	6	7,790
HFB 4030-0450	R1.5	4.5	16°	60	6	6,890
HFB 4040-0600	R2	6	16°	70	6	6,890
HFB 4060-0900	R3	9	—	80	6	8,610
HFB 4080-1200	R4	12	—	90	8	12,300
HFB 4100-1500	R5	15	—	100	10	16,320
HFB 4120-1800	R6	18	—	110	12	20,660



Size R1~R6

HFB Short Shank

Patented in Japan, China, Korea, Taiwan, Germany, Switzerland, and Liechtenstein

HFB-S

Super MG

HARD MAX

40°

R ±0.005
R1~R1.5

R ±0.007
R2~R3

R ±0.01
R4~R6

Shank Dia
0/-0.005

Material Applications (☆ Highly Recommended ○ Recommended ○ Suggested)

Work Material															
Carbon Steels S45C S55C	Alloy Steels SK / SCM SUS	Prehardened Steels NAK HPM	Hardened Steels			Cast Iron	Aluminum Alloys	Graphite	Copper	Plastics	Glass Filled Plastics	Titanium Alloys	Heat Resistant Alloys	Cemented Carbide	Hard Brittle (Non-Metallic) Materials
			~55HRC	~60HRC	~70HRC										
			○	○	○										

Features

Compatible with shrink-fit toolholder systems for high efficiency.
A shorter overhang offers higher feed rates and precision.
Diameter Tolerance: 0/-0.02

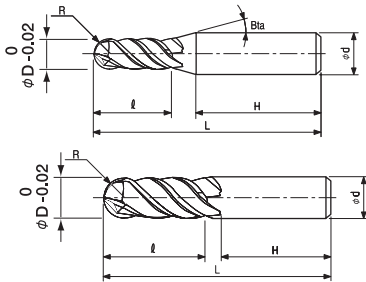

The shank taper angle and the shank length (H) shown are not an exact value and to avoid contact with the work piece, we recommend the user controls the precise value of this angle. Shank taper angle should not make contact with the work piece.

Total 7 models

Unit (mm)

Model Number	Radius of Ball Nose R	Length of Cut ℓ	Shank Taper Angle βta	Overall Length L	Shank Diameter φd	Shank Length H	Price ¥
HFB 4020-0300S	R1	3	16°	40	4	31.0	6,720
HFB 4030-0450S	R1.5	4.5	16°	40	4	30.5	6,890
HFB 4040-0600S	R2	6	16°	45	6	32.5	6,890
HFB 4060-0900S	R3	9	—	50	6	34.5	8,610
HFB 4080-1200S	R4	12	—	60	8	40.5	12,300
HFB 4100-1500S	R5	15	—	60	10	35.5	16,320
HFB 4120-1800S	R6	18	—	60	12	31.5	20,660

4 Flutes

UDC Series

CBN Series

Square

Long Neck Square

Radius

Long Neck Radius

Taper Neck Radius

Ball / Long Shank Ball

Long Neck Ball

Taper Neck Ball

Taper

Spiral V Cutter

Drill

EURO Series

Technical Data

Milling Conditions for HFB / HFB-S

◆Roughing

WORK MATERIAL		PREHARDENED STEELS NAK80 (35~45HRC) Coolant: Water Soluble / Air Blow / Oil Mist				HARDENED STEELS STAVAX / SKD61 (45~55HRC) Coolant: Air Blow / Oil Mist			
Model Number	Radius of Ball Nose (mm)	Spindle Speed (min ⁻¹)	Feed Rate (mm/min)	a _p Axial Depth (mm)	a _e Radial Depth (mm)	Spindle Speed (min ⁻¹)	Feed Rate (mm/min)	a _p Axial Depth (mm)	a _e Radial Depth (mm)
4020-0300	R1	20,000	1,500	0.5	0.8	16,000	1,500	0.6	0.9
4030-0450	R1.5	16,000	2,000	0.6	0.9	10,500	1,500	0.9	1.35
4040-0600	R2	15,000	3,000	0.4	0.8	9,000	3,000	0.7	1.4
4060-0900	R3	9,000	2,500	0.5	1	8,000	3,500	0.6	1.8
4080-1200	R4	CFB Series are Recommended				6,200	3,000	0.75	2.1
4100-1500	R5					4,500	2,700	0.85	2.5
4120-1800	R6					3,750	2,700	0.95	3

WORK MATERIAL		HARDENED STEELS YXR33 / SKD11 (55~60HRC) Coolant: Air Blow / Oil Mist				HARDENED STEELS HAP10 / SKD11 / YXR7 (60~65HRC) Coolant: Air Blow / Oil Mist			
Model Number	Radius of Ball Nose (mm)	Spindle Speed (min ⁻¹)	Feed Rate (mm/min)	a _p Axial Depth (mm)	a _e Radial Depth (mm)	Spindle Speed (min ⁻¹)	Feed Rate (mm/min)	a _p Axial Depth (mm)	a _e Radial Depth (mm)
4020-0300	R1	10,000	1,500	0.4	0.8	8,500	1,200	0.3	0.7
4030-0450	R1.5	6,500	1,500	0.6	1.2	5,500	1,200	0.5	1.1
4040-0600	R2	5,500	1,750	0.6	1.2	6,200	2,000	0.45	1
4060-0900	R3	4,500	1,750	0.6	1.5	5,000	2,000	0.45	1.2
4080-1200	R4	3,750	1,500	0.7	1.75	4,500	1,800	0.5	1.4
4100-1500	R5	3,000	1,500	0.75	2	3,600	1,800	0.6	1.6
4120-1800	R6	2,500	1,500	0.9	2.4	3,000	1,800	0.7	1.8

WORK MATERIAL		HARDENED STEELS HAP72 (65~70HRC) Coolant: Air Blow / Oil Mist			
Model Number	Radius of Ball Nose (mm)	Spindle Speed (min ⁻¹)	Feed Rate (mm/min)	a _p Axial Depth (mm)	a _e Radial Depth (mm)
4020-0300	R1	10,500	750	0.2	0.6
4030-0450	R1.5	7,000	750	0.25	0.8
4040-0600	R2	7,500	1,200	0.2	0.6
4060-0900	R3	5,000	1,500	0.3	0.9
4080-1200	R4	4,000	1,500	0.3	1
4100-1500	R5	3,000	1,500	0.3	1.2
4120-1800	R6	2,500	1,300	0.3	1.4

- UDC Series
- CBN Series
- Square
- Long Neck Square
- Radius
- Long Neck Radius
- Taper Neck Radius
- Ball / Long Shank Ball
- Long Neck Ball
- Taper Neck Ball
- Taper
- Spiral V Cutter
- Drill
- EURO Series
- Technical Data

Milling Conditions for HFB / HFB-S

Please adjust milling parameter according to overhang length, referring to the following table.

Radius of Ball Nose R1 ($\phi 4$ shank), R1.5

Overhang Length	Spindle Speed (min ⁻¹)	Feed Rate (mm/min)	a_p Axial Depth (mm)	a_e Radial Depth (mm)
$\phi D \times 5$ or below	$\times 1$	$\times 1$	$\times 1$	$\times 1$
$\sim \phi D \times 6$	$\times 0.9$	$\times 0.9$	$\times 0.95$	$\times 0.95$
$\sim \phi D \times 7$	$\times 0.8$	$\times 0.8$	$\times 0.9$	$\times 0.95$
$\sim \phi D \times 8$	$\times 0.7$	$\times 0.7$	$\times 0.85$	$\times 0.9$
$\sim \phi D \times 9$	$\times 0.65$	$\times 0.6$	$\times 0.8$	$\times 0.9$
$\sim \phi D \times 10$	$\times 0.55$	$\times 0.5$	$\times 0.75$	$\times 0.85$

Radius of Ball Nose R1 ($\phi 6$ shank)

Overhang Length	Spindle Speed (min ⁻¹)	Feed Rate (mm/min)	a_p Axial Depth (mm)	a_e Radial Depth (mm)
$\phi D \times 6$	$\times 1$	$\times 1$	$\times 1$	$\times 1$
$\sim \phi D \times 7$	$\times 0.85$	$\times 0.9$	$\times 0.95$	$\times 0.95$
$\sim \phi D \times 8$	$\times 0.7$	$\times 0.8$	$\times 0.9$	$\times 0.9$
$\sim \phi D \times 9$	$\times 0.55$	$\times 0.75$	$\times 0.85$	$\times 0.9$
$\sim \phi D \times 10$	$\times 0.4$	$\times 0.65$	$\times 0.8$	$\times 0.85$

Radius of Ball Nose R1.5 (Short shank)

Overhang Length	Spindle Speed (min ⁻¹)	Feed Rate (mm/min)	a_p Axial Depth (mm)	a_e Radial Depth (mm)
$\phi D \times 5$ or below	$\times 1$	$\times 1$	$\times 1$	$\times 1$
$\sim \phi D \times 6$	$\times 0.55$	$\times 0.3$	$\times 0.4$	$\times 0.55$

Radius of Ball Nose R2 or above

Overhang Length	Spindle Speed (min ⁻¹)	Feed Rate (mm/min)	a_p Axial Depth (mm)	a_e Radial Depth (mm)
$\phi D \times 3$ or below	$\times 1$	$\times 1$	$\times 1$	$\times 1$
$\sim \phi D \times 3.5$	$\times 1$	$\times 0.85$	$\times 0.85$	$\times 0.9$
$\sim \phi D \times 4$	$\times 1$	$\times 0.8$	$\times 0.7$	$\times 0.8$
$\sim \phi D \times 4.5$	$\times 0.85$	$\times 0.55$	$\times 0.6$	$\times 0.75$
$\sim \phi D \times 5$	$\times 0.7$	$\times 0.35$	$\times 0.6$	$\times 0.75$
$\sim \phi D \times 5.5$	$\times 0.55$	$\times 0.25$	$\times 0.55$	$\times 0.7$
$\sim \phi D \times 6$	$\times 0.4$	$\times 0.15$	$\times 0.5$	$\times 0.7$

* Refer to next page for finishing condition.

HFB Series
SKD11 (60HRC)
Milling Video



4 Flutes

UDC Series

CBN Series

Square

Long Neck Square

Radius

Long Neck Radius

Taper Neck Radius

Ball / Long Shank Ball

Long Neck Ball

Taper Neck Ball

Taper

Spiral V Cutter

Drill

EURO Series

Technical Data

Milling Conditions for HFB / HFB-S

◆ Finishing (overhang length ~6D)

WORK MATERIAL		PREHARDENED STEELS / HARDENED STEELS (35~60HRC) Coolant: Oil Mist			
Model Number	Radius of Ball Nose (mm)	Spindle Speed (min ⁻¹)	Feed Rate (mm/min)	a_p Axial Depth (mm)	a_e Radial Depth (mm)
4020-0300	R1	26,000	2,000	0.02	0.06
4030-0450	R1.5	25,000	1,800	0.03	0.07
4040-0600	R2	22,500	1,500	0.04	0.08
4060-0900	R3	15,000	1,000	0.06	0.12
4080-1200	R4	11,250	750	0.08	0.16
4100-1500	R5	9,000	600	0.1	0.2
4120-1800	R6	7,500	500	0.12	0.24

a_p : Axial Depth (mm)
 a_e : Radial Depth (mm)

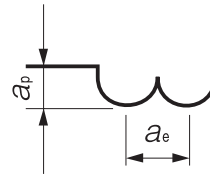

Note:

- Decrease the feed rate more than 50% from the milling parameters when slot milling.
- Decrease both spindle speed and feed rate proportionally when the milling parameters exceed the machines maximum speed, or when the tool is chattering and heats up to a red color.
- Adjustments are recommended when finishing with an overhang of over 6xD.
- Recommend air blow or oil mist. For materials under 45HRC, recommend water soluble coolant.

Feature 1 Special Design Achieves Outstanding Chip Evacuation

HFB Design

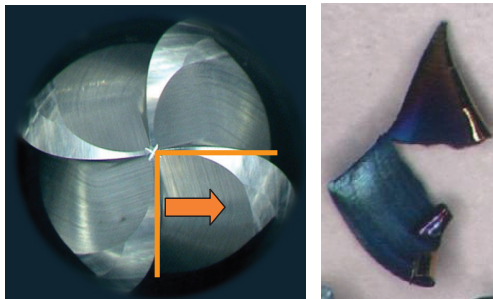

Flat (Non-rolled up) chip shape shows smooth chip evacuation.

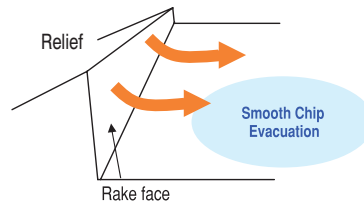

Conventional Design

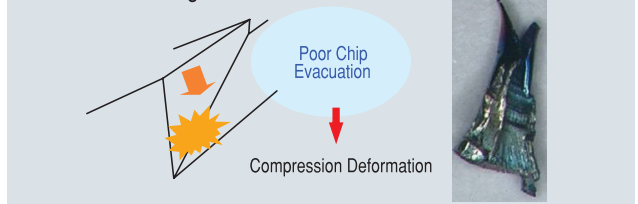

Smooth chip evacuation achieves more stable milling.

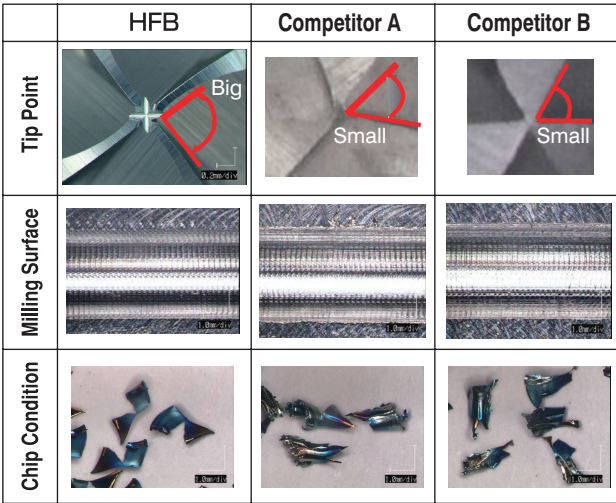

Tool	R2
Work Material	YXR33 (58HRC)
Spindle Speed	6,000 min ⁻¹
Feed Rate	2,400 mm/min (Slotting : 1,200 mm/min)
Axial Depth a_p	1 mm (0.25D)
Radial Depth a_e	1 mm (0.25D)
Overhang Length	15 mm
Coolant	Air Blow (Through Spindle)
Pocket Size	100 mm × 20 mm × 6 mm (X × Y × Z)
Cycle Time	28.2 min

D : Outside Diameter

The large pocket design of the HFB promotes better chip evacuation and longer tool life when compared to a conventional design which shows premature damage.

Feature 2 Polish-less Milling by 4 Tip Grooves

STAVAX (53HRC) Milling Example: Flat Surface Finishing HFB (R3)

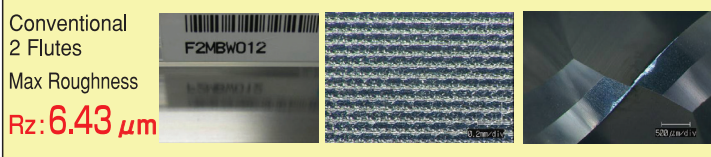
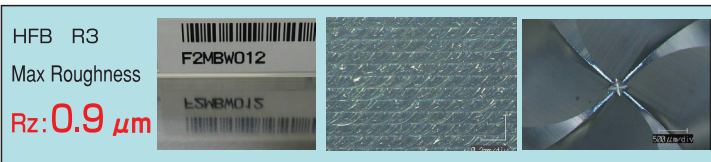

Spindle Speed	12,800 min ⁻¹
Feed Rate	2,500 mm/min
Axial Depth a_p	0.06 mm (0.01D)
Radial Depth a_e	0.12 mm (0.02D)
Coolant	Oil Mist

4 grooves on the tip point help surface finishing process. Max roughness values was 0.9 μm on 1 hour testing.

The tool condition is better than conventional 2 Flutes.

Tip point

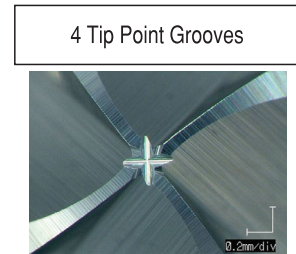
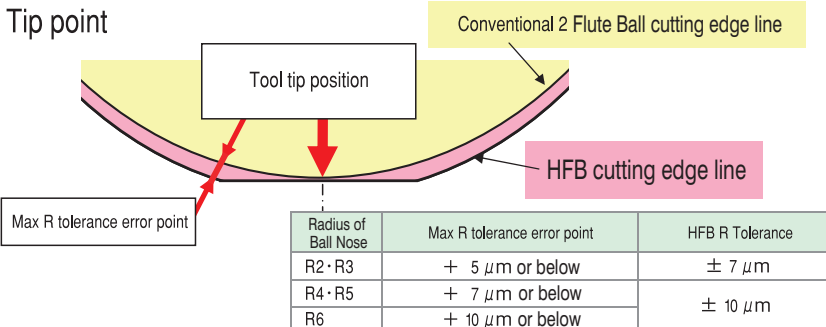

Smooth chip evacuation reduces damage at the tip.

4 Flutes

UDC Series

CBN Series

Square

Long Neck Square

Radius

Long Neck Radius

Taper Neck Radius

Ball / Long Shank Ball

Long Neck Ball

Taper Neck Ball

Taper

Spiral V Cutter

Drill

EURO Series

Technical Data



Size R2~R10

CGB4000



Material Applications (☆ Highly Recommended ● Recommended ○ Suggested)

Work Material															
Carbon Steels	Alloy Steels	Prehardened Steels	Hardened Steels			Cast Iron	Aluminum Alloys	Graphite	Copper	Plastics	Glass Filled Plastics	Titanium Alloys	Heat Resistant Alloys	Cemented Carbide	Hard Brittle (Non-Metallic) Materials
			~55HRC	~60HRC	~70HRC										
S45C S55C	SK / SCM SUS	NAK HPM					○	☆	○	○	○				

Features

Designed for milling Graphite.
The chosen carbide grade offers excellent wear resistance.
Refer to page 414 for 2 flute CGB.

Actual measurement is necessary when using longer length of cut than the written length.

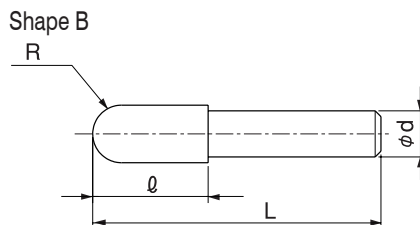
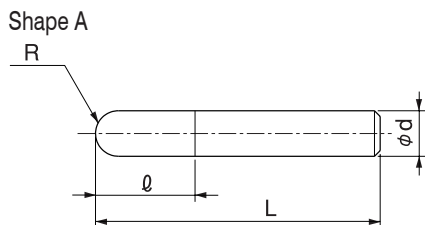

Total 9 models

Unit (mm)

Model Number	Radius of Ball Nose R	Length of Cut ℓ	Overall Length L	Shank Diameter φd	Shape	Price ¥
CGB 4040	R2	20	100	4	A	21,900
CGB 4050	R2.5	20	100	5	A	22,200
CGB 4060	R3	30	150	6	A	25,200
CGB 4070	R3.5	30	150	6	B	28,250
CGB 4080	R4	40	150	8	A	31,900
CGB 4100	R5	50	180	10	A	39,380
CGB 4120	R6	55	200	12	A	46,090
CGB 4160	R8	60	200	16	A	65,010
CGB 4200	R10	60	250	20	A	98,560

Milling Conditions for CGB (4 Flutes)

WORK MATERIAL		GRAPHITE			
Model Number	Radius of Ball Nose (mm)	Spindle Speed (min ⁻¹)	Feed Rate (mm/min)	a_p Axial Depth (mm)	a_e Radial Depth (mm)
4040	R2	15,000	1,350~1,600	1.2	2.8
4050	R2.5	15,000	1,350~1,600	1.5	3.5
4060	R3	15,000	1,900~2,300	1.8	4.2
4070	R3.5	9,000	1,900~2,300	2.1	4.9
4080	R4	8,000	1,900~2,300	2.4	5.6
4100	R5	6,500	2,000~2,500	3	7
4120	R6	5,300	2,000~2,500	3.6	8.4
4160	R8	4,000	2,000~2,500	4.8	11.2
4200	R10	3,200	2,000~2,500	6	14

For 3D milling / Finishing
Milling Amount (mm)

$$a_p = 0.3D$$

$$a_e = 0.7D$$

a_p : Axial Depth (mm)

a_e : Radial Depth (mm)

D : Outside Diameter (mm)

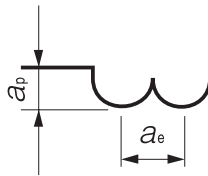

Note:

- Use a milling machine dedicated for Graphite.
- Recommend air blow for Graphite.

4 Flutes

UDC Series

CBN Series

Square

Long Neck Square

Radius

Radius

Long Neck Radius

Taper Neck Radius

Ball / Long Shank Ball

Ball

Long Neck Ball

Taper Neck Ball

Taper

Taper

Spiral

V Cutter

Drill

EURO Series

Technical Data



Size R0.1~R1

UPDLB



Material Applications (☆ Highly Recommended ● Recommended ○ Suggested)

Work Material															
Carbon Steels	Alloy Steels	Prehardened Steels	Hardened Steels			Cast Iron	Aluminum Alloys	Graphite	Copper	Plastics	Glass Filled Plastics	Titanium Alloys	Heat Resistant Alloys	Cemented Carbide	Hard Brittle (Non-Metallic) Materials
			~55HRC	~60HRC	~70HRC										
S45C S55C	SK / SCM SUS	NAK HPM												☆	●

Features

Long Neck Ball type End Mills for finishing of Cemented Carbide and Hard Brittle Materials.
 Provides excellent machined surface quality due to the sharp cutting edge and optimized edge treatment.
 Maintains excellent dimensional accuracy for a long time due to the high contour accuracy of the cutting edge and the excellent wear resistance of diamonds.

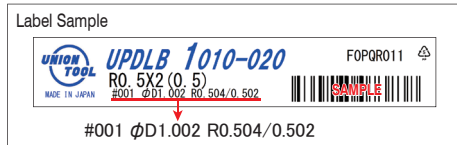

Diameter and Ball R accuracy measurements are printed on the label to support high precision milling.

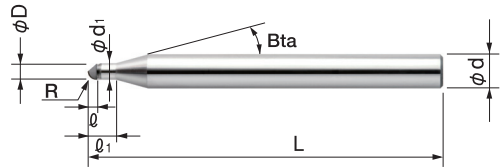

Be sure to confirm the interference between the inclined work piece and the shank part by actual measurement.

Total 5 models

Unit (mm)

Model Number	Radius of Ball Nose R	Effective Length l_1	Length of Cut l	Neck Diameter ϕ_{d1}	Shank Taper Angle Bta	Overall Length L	Shank Diameter ϕ_d	Price ¥
UPDLB 1002-004	R0.1	0.4	0.1	0.18	16°	40	4	Open price
UPDLB 1004-008	R0.2	0.8	0.2	0.38	16°	40	4	Open price
UPDLB 1006-010	R0.3	1	0.3	0.58	16°	40	4	Open price
UPDLB 1010-020	R0.5	2	0.5	0.95	16°	40	4	Open price
UPDLB 1020-030	R1	3	1	1.95	16°	40	4	Open price

Milling Conditions for UPDLB

For finishing of bottom surface

WORK MATERIAL			CEMENTED CARBIDE			
Model Number	Radius of Ball Nose (mm)	Effective Length (mm)	Spindle Speed (min ⁻¹)	Feed Rate (mm/min)	a_p Axial Depth (mm)	a_e Radial Depth (mm)
1002-004	R0.1	0.4	40,000	100	0.001	0.001
1004-008	R0.2	0.8	40,000	150	0.001	0.001
1006-010	R0.3	1	40,000	200	0.001	0.001
1010-020	R0.5	2	40,000	400	0.001	0.003
1020-030	R1	3	40,000	600	0.001	0.005

For Profile milling

WORK MATERIAL			CEMENTED CARBIDE			
Model Number	Radius of Ball Nose (mm)	Effective Length (mm)	Spindle Speed (min ⁻¹)	Feed Rate (mm/min)	a_p Axial Depth (mm)	a_e Radial Depth (mm)
1002-004	R0.1	0.4	40,000	100	0.001	0.001
1004-008	R0.2	0.8	40,000	150	0.002	0.001
1006-010	R0.3	1	40,000	200	0.003	0.001
1010-020	R0.5	2	40,000	400	0.005	0.003
1020-030	R1	3	40,000	600	0.01	0.005



- Note:
- Use a machine with high accuracy for stable cutting.
 - Non-water soluble coolant recommended. Supply as a mist or external coolant. Take fire prevention precautions to avoid fire hazards caused by sparks igniting during machining or tool breakage.
 - Shorten overhang as much as possible.
 - Adjust cutting conditions as necessary as machine spec and other conditions may vary.
 - These cutting parameters show reference value. Adjust the cutting conditions to the desired machined surface finish.

UPDLB Milling Example for Finishing UDCBF / UPDLB R0.5 Cemented Carbide VF-20 (92.5HRA)

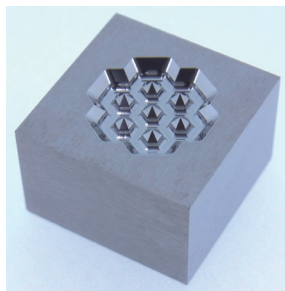

Milling Area : 10.2 × 10.2 × Depth 1.4 mm

Work Size : 20 × 20 × 10 mm

After Finishing

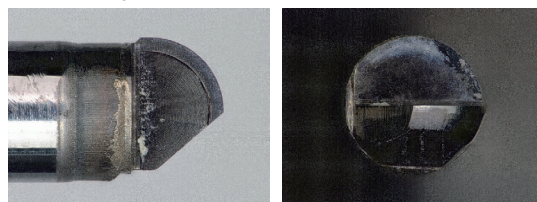

Milling Process	Tool	Spindle Speed (min ⁻¹)	Feed Rate (mm/min)	a_p Axial Depth (mm)	a_e Radial Depth (mm)	Allowance (mm)	Coolant	Cycle Time
Roughing	UDCBF 2010-0070 (R0.5 × Length of Cut 0.7)	30,000	300	0.05	0.25	0.005	Air Blow	30 min
Semi-finishing		30,000	300	0.001 (Cusp Height)	0.06321	0.005		12 min
Finishing	UPDLB 1010-020 (R0.5 × Effective Length 2)	40,000	400	0.0035	0.00495	0	Oil Mist	1 h 30 min

UDC Series

CBN Series

Square

Square
Long Neck Square

Radius

Radius
Long Neck RadiusRadius
Taper Neck Radius

Ball / Long Shank Ball

Ball
Long Neck BallBall
Taper Neck BallTaper
TaperSpiral
V Cutter

Drill

EURO Series

Technical Data



Size R0.05~R3

HGLB

Super
MG

HMG
COAT

30°

R
±0.002

R
±0.003

R
±0.005

Shank Dia
0/-0.004

Back Taper
Geometry

Additional 61 models

~ Except for R0.4 or below.
ℓ, / D ≤ 10

R0.05~R0.075 R0.1~R2 R2.5~R3

Material Applications (☆ Highly Recommended ○ Recommended ○ Suggested)

Work Material															
Carbon Steels S45C S55C	Alloy Steels SK / SCM SUS	Prehardened Steels NAK HPM	Hardened Steels			Cast Iron	Aluminum Alloys	Graphite	Copper	Plastics	Glass Filled Plastics	Titanium Alloys	Heat Resistant Alloys	Cemented Carbide	Hard Brittle (Non-Metallic) Materials
			~55HRC	~60HRC	~70HRC										
		○	○	○	○										

Features

Developed to achieve long tool life and high precision milling on hard materials. A combination of the new "HMGCOAT" and new carbide material offer a higher wear resistance compared to conventional end mills. Also new design with improved breakage resistance offers high precision diameter tolerance, radius accuracy and shank diameter tolerance.

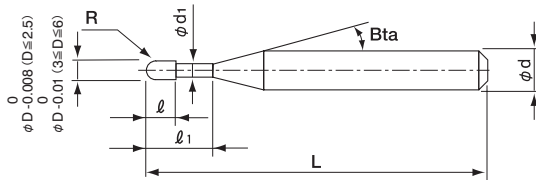
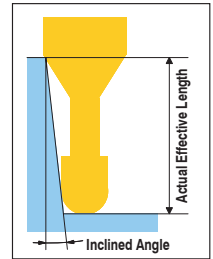

The shank taper angle shown is not an exact value and to avoid contact with the workpiece, we recommend the user controls the precise value of this angle. Shank taper angle should not make contact with the work piece.

High Precision Diameter Tolerance / Radius Accuracy / Shank Diameter Tolerance

HSLB Tolerance

Radius of Ball Nose	Diameter Tolerance	Ball Radius Accuracy	Shank Diameter Tolerance
R0.03 ~ R0.075	0/-0.01	±0.002	0/-0.005 (h5)
R0.1 ~ R3	0/-0.015	±0.005	

HGLB Tolerance

Radius of Ball Nose	Diameter Tolerance	Ball Radius Accuracy	Shank Diameter Tolerance
R0.05 ~ R0.075	0/-0.008	±0.002	0/-0.004 (h4)
R0.1 ~ R1.25		±0.003	
R1.5 ~ R2	0/-0.01	±0.005	
R2.5 ~ R3			

Shank diameter tolerance h4!

- UDC Series
- CBN Series
- Square
- Long Neck Square
- Radius
- Long Neck Radius
- Taper Neck Radius
- Ball / Long Shank Ball
- Long Neck Ball
- Taper Neck Ball
- Taper
- Spiral V Cutter
- Drill
- EURO Series
- Technical Data

Total 155 models

Unit (mm)

2 Flutes

Model Number	Radius of Ball Nose R	Effective Length ℓ_1	Length of Cut ℓ	Neck Diameter ϕ_d	Shank Taper Angle Bia	Overall Length L	Shank Diameter ϕd	Price ¥	Effective Length by Inclined Angles				
									30°	1°	1°30'	2°	3°
※ HGLB 2001-002	R0.05	0.2	0.08	0.095	16°	45	4	12,360	0.22	0.24	0.26	0.28	0.31
※ HGLB 2001-003		0.3				45	4	12,360	0.33	0.36	0.38	0.40	0.44
※ HGLB 2001-005		0.5				45	4	13,440	0.55	0.58	0.61	0.64	0.68
※ HGLB 2015-003	R0.075	0.3	0.12	0.14	16°	45	4	14,400	0.35	0.37	0.39	0.41	0.44
※ HGLB 2015-005		0.5				45	4	15,240	0.56	0.59	0.62	0.64	0.69
※ HGLB 2015-0075		0.75				45	4	16,020	0.83	0.86	0.90	0.93	1.00
※ HGLB 2015-010	R0.1	1	0.16	0.19	16°	45	4	16,020	1.09	1.13	1.17	1.21	1.30
※ HGLB 2002-003		0.3				45	4	8,640	0.42	0.44	0.46	0.48	0.52
※ HGLB 2002-005		0.5				45	4	8,640	0.63	0.66	0.68	0.71	0.76
※ HGLB 2002-0075	R0.1	0.75	0.16	0.19	16°	45	4	8,640	0.89	0.93	0.96	0.99	1.07
※ HGLB 2002-010		1				45	4	8,640	1.15	1.20	1.24	1.28	1.37
※ HGLB 2002-015		1.5				45	4	9,360	1.66	1.72	1.78	1.84	1.97
※ HGLB 2002-020	R0.15	2	0.24	0.29	16°	45	4	10,440	2.18	2.25	2.33	2.41	2.58
※ HGLB 2003-005		0.5				45	4	8,520	0.63	0.65	0.68	0.70	0.75
※ HGLB 2003-0075		0.75				45	4	8,520	0.89	0.92	0.96	0.99	1.05
※ HGLB 2003-010	R0.15	1	0.24	0.29	16°	45	4	8,520	1.15	1.19	1.23	1.27	1.36
※ HGLB 2003-015		1.5				45	4	9,120	1.66	1.72	1.77	1.83	1.96
※ HGLB 2003-020		2				45	4	9,120	2.18	2.25	2.32	2.40	2.57
※ HGLB 2003-025	R0.2	2.5	0.32	0.39	16°	45	4	9,360	2.70	2.78	2.87	2.97	3.18
※ HGLB 2003-030		3				45	4	9,360	3.21	3.32	3.42	3.54	3.80
※ HGLB 2004-005		0.5				45	4	5,880	0.63	0.65	0.67	0.70	0.74
※ HGLB 2004-0075	R0.2	0.75	0.32	0.39	16°	45	4	5,880	0.89	0.92	0.95	0.98	1.04
※ HGLB 2004-010		1				45	4	5,880	1.15	1.19	1.23	1.26	1.35
※ HGLB 2004-010-6		1				50	6	8,640	1.15	1.19	1.23	1.26	1.35
※ HGLB 2004-0125	R0.2	1.25	0.32	0.39	16°	45	4	6,000	1.40	1.45	1.49	1.54	1.64
※ HGLB 2004-015		1.5				45	4	6,000	1.66	1.71	1.77	1.82	1.95
※ HGLB 2004-015-6		1.5				50	6	8,740	1.66	1.71	1.77	1.82	1.95
※ HGLB 2004-020	R0.2	2	0.32	0.39	16°	45	4	6,120	2.18	2.25	2.32	2.39	2.56
※ HGLB 2004-020-6		2				50	6	9,000	2.18	2.25	2.32	2.39	2.56
※ HGLB 2004-025		2.5				45	4	6,360	2.70	2.78	2.87	2.96	3.17
※ HGLB 2004-025-6	R0.2	2.5	0.32	0.39	16°	45	4	6,360	2.70	2.78	2.87	2.96	3.17
※ HGLB 2004-030		3				45	4	6,720	3.21	3.31	3.42	3.53	3.79
※ HGLB 2004-030-6		3				50	6	9,850	3.21	3.31	3.42	3.53	3.79
※ HGLB 2004-035	R0.25	3.5	0.4	0.49	16°	45	4	7,320	3.73	3.84	3.97	4.10	4.40
※ HGLB 2004-040		4				45	4	7,320	4.24	4.38	4.52	4.67	5.01
※ HGLB 2005-010		1				45	4	5,880	1.15	1.19	1.22	1.26	1.34
※ HGLB 2005-015	R0.25	1.5	0.4	0.49	16°	45	4	5,880	1.65	1.71	1.76	1.82	1.94
※ HGLB 2005-020		2				45	4	5,880	2.18	2.24	2.31	2.39	2.55
※ HGLB 2005-025		2.5				45	4	5,880	2.69	2.78	2.86	2.96	3.16
※ HGLB 2005-030	R0.25	3	0.4	0.49	16°	45	4	5,880	3.21	3.31	3.41	3.53	3.77
※ HGLB 2005-035		3.5				45	4	5,880	3.73	3.84	3.96	4.09	4.39
※ HGLB 2005-040		4				45	4	5,880	4.24	4.37	4.51	4.66	5.00
※ HGLB 2005-045	R0.25	4.5	0.4	0.49	16°	45	4	6,000	4.76	4.91	5.06	5.23	5.61
※ HGLB 2005-050		5				45	4	6,000	5.27	5.44	5.61	5.80	6.22
※ HGLB 2005-060		6				45	4	6,120	6.30	6.50	6.71	6.94	7.45

※Additional model

Next Page ➡

- UDC Series
- CBN Series
- Square
- Long Neck Square
- Radius
- Long Neck Radius
- Taper Neck Radius
- Ball / Long Shank Ball
- Long Neck Ball
- Taper Neck Ball
- Taper
- Spiral V Cutter
- Drill
- EURO Series
- Technical Data

Model Number	Radius of Ball Nose R	Effective Length ℓ_1	Length of Cut ℓ	Neck Diameter ϕd_1	Shank Taper Angle Bta	Overall Length L	Shank Diameter ϕd	Price ¥	Effective Length by Inclined Angles								
									30°	1°	1°30'	2°	3°				
HGLB 2006-010	RO.3	1	0.48	0.59	16°	45	4	5,040	1.14	1.18	1.22	1.25	1.33				
HGLB 2006-015		1.5				45	4	4,560	1.65	1.71	1.76	1.81	1.93				
※ HGLB 2006-015-6		1.5				50	6	6,890	1.65	1.71	1.76	1.81	1.93				
HGLB 2006-020		2				45	4	4,560	2.17	2.24	2.31	2.38	2.54				
※ HGLB 2006-020-6		2				50	6	6,960	2.17	2.24	2.31	2.38	2.54				
HGLB 2006-025		2.5				45	4	4,680	2.69	2.77	2.86	2.95	3.15				
※ HGLB 2006-025-6		2.5				50	6	6,890	2.69	2.77	2.86	2.95	3.15				
HGLB 2006-030		3				45	4	4,680	3.21	3.31	3.41	3.52	3.76				
※ HGLB 2006-030-6		3				50	6	7,080	3.21	3.31	3.41	3.52	3.76				
※ HGLB 2006-035		3.5				45	4	4,800	3.72	3.84	3.96	4.09	4.38				
HGLB 2006-040		4				45	4	4,800	4.24	4.37	4.51	4.66	4.99				
※ HGLB 2006-045		4.5				45	4	4,800	4.76	4.90	5.06	5.23	5.60				
HGLB 2006-050		5				45	4	4,800	5.27	5.44	5.61	5.80	6.21				
※ HGLB 2006-055		5.5				45	4	4,800	5.79	5.97	6.16	6.37	6.82				
HGLB 2006-060		6				45	4	4,800	6.30	6.50	6.71	6.93	7.43				
HGLB 2006-080		8				45	4	6,360	8.37	8.63	8.91	9.21	9.88				
※ HGLB 2006-100		10				45	4	6,480	10.43	10.76	11.11	11.49	12.33				
HGLB 2008-020		RO.4				2	0.64	0.79	16°	45	4	4,560	2.17	2.23	2.30	2.37	2.52
※ HGLB 2008-025						2.5				45	4	4,800	2.69	2.77	2.85	2.94	3.13
※ HGLB 2008-030						3				45	4	4,800	3.21	3.30	3.40	3.50	3.74
HGLB 2008-040	4		45	4	4,800	4.24				4.36	4.50	4.64	4.97				
※ HGLB 2008-050	5		45	4	4,800	5.27				5.43	5.60	5.78	6.19				
HGLB 2008-060	6		45	4	4,800	6.30				6.49	6.70	6.92	7.41				
※ HGLB 2008-070	7		45	4	4,800	7.33				7.56	7.80	8.06	8.64				
HGLB 2008-080	8		45	4	4,800	8.36				8.62	8.90	9.20	9.86				
※ HGLB 2010-020	2		45	4	3,840	2.18				2.24	2.30	2.36	2.51				
※ HGLB 2010-020-6	2		50	6	6,120	2.18				2.24	2.30	2.36	2.51				
HGLB 2010-025	2.5	45	4	3,840	2.70	2.77	2.85	2.93	3.12								
HGLB 2010-030	3	45	4	3,840	3.21	3.30	3.40	3.50	3.73								
※ HGLB 2010-030-6	3	50	6	6,120	3.21	3.30	3.40	3.50	3.73								
HGLB 2010-040	4	45	4	4,320	4.24	4.37	4.50	4.64	4.96								
※ HGLB 2010-040-6	4	50	6	6,720	4.24	4.37	4.50	4.64	4.96								
HGLB 2010-050	5	45	4	4,320	5.28	5.43	5.60	5.78	6.18								
※ HGLB 2010-050-6	5	50	6	6,720	5.28	5.43	5.60	5.78	6.18								
HGLB 2010-060	RO.5	6	0.8	0.98	16°	45	4	4,680	6.31	6.50	6.70	6.92	7.40				
※ HGLB 2010-060-6		6				50	6	7,080	6.31	6.50	6.70	6.92	7.40				
※ HGLB 2010-070		7				45	4	4,680	7.34	7.56	7.80	8.06	8.63				
※ HGLB 2010-070-6		7				50	6	7,080	7.34	7.56	7.80	8.06	8.63				
HGLB 2010-080		8				45	4	4,680	8.37	8.63	8.90	9.20	9.85				
※ HGLB 2010-080-6		8				50	6	7,080	8.37	8.63	8.90	9.20	9.85				
HGLB 2010-100		10				45	4	4,680	10.43	10.76	11.10	11.47	12.30				
※ HGLB 2010-100-6		10				50	6	7,080	10.43	10.76	11.10	11.47	12.30				
HGLB 2010-120		12				45	4	4,680	12.50	12.89	13.30	13.75	14.75				
HGLB 2010-140		14				45	4	5,400	14.56	15.02	15.51	16.03	17.19				
※ HGLB 2010-160	16	50	4	6,360	16.62	17.15	17.71	18.31	19.64								

※Additional model

Model Number	Radius of Ball Nose R	Effective Length ℓ_1	Length of Cut ℓ	Neck Diameter ϕ_d	Shank Taper Angle Bia	Overall Length L	Shank Diameter ϕ_d	Price ¥	Effective Length by Inclined Angles				
									30°	1°	1°30'	2°	3°
HGLB 2015-030	R0.75	3	1.2	1.47	16°	45	4	4,440	3.10	3.18	3.26	3.35	3.55
※ HGLB 2015-030-6		3				50	6	7,130	3.10	3.18	3.26	3.35	3.55
HGLB 2015-040		4				45	4	4,440	4.13	4.24	4.36	4.49	4.77
HGLB 2015-060		6				45	4	4,440	6.19	6.37	6.56	6.76	7.22
※ HGLB 2015-060-6		6				50	6	7,200	6.19	6.37	6.56	6.76	7.22
HGLB 2015-080		8				45	4	4,680	8.25	8.50	8.76	9.04	9.67
※ HGLB 2015-080-6		8				50	6	7,200	8.25	8.50	8.76	9.04	9.67
HGLB 2015-100		10				45	4	5,040	10.32	10.63	10.96	11.32	12.11
※ HGLB 2015-100-6		10				50	6	7,200	10.32	10.63	10.96	11.32	12.11
HGLB 2015-120		12				45	4	5,400	12.38	12.76	13.16	13.60	14.56
※ HGLB 2015-120-6		12				50	6	8,130	12.38	12.76	13.16	13.60	14.56
HGLB 2015-140		14				45	4	5,400	14.44	14.89	15.36	15.87	17.01
※ HGLB 2015-160	16	50	4	5,400	16.50	17.02	17.57	18.15	19.46				
※ HGLB 2015-200	20	60	4	5,400	20.63	21.28	21.97	22.71	24.35				
HGLB 2020-030	R1	3	1.6	1.98	16°	45	4	3,840	3.07	3.14	3.21	3.29	3.47
※ HGLB 2020-030-6		3				50	6	6,120	3.07	3.14	3.21	3.29	3.47
HGLB 2020-040		4				45	4	3,840	4.10	4.20	4.31	4.43	4.70
HGLB 2020-040-6		4				50	6	6,120	4.10	4.20	4.31	4.43	4.70
HGLB 2020-060		6				45	4	4,320	6.16	6.33	6.51	6.71	7.14
HGLB 2020-060-6		6				50	6	6,600	6.16	6.33	6.51	6.71	7.14
HGLB 2020-080		8				45	4	4,680	8.23	8.46	8.72	8.99	9.59
HGLB 2020-080-6		8				50	6	7,080	8.23	8.46	8.72	8.99	9.59
HGLB 2020-100		10				45	4	4,680	10.29	10.59	10.92	11.26	12.04
HGLB 2020-100-6		10				50	6	7,080	10.29	10.59	10.92	11.26	12.04
HGLB 2020-120		12				45	4	4,680	12.35	12.72	13.12	13.54	14.48
HGLB 2020-120-6		12				50	6	7,080	12.35	12.72	13.12	13.54	14.48
HGLB 2020-140		14				45	4	4,680	14.41	14.85	15.32	15.82	16.93
HGLB 2020-160		16				45	4	4,680	16.48	16.98	17.52	18.10	19.38
HGLB 2020-200		20				60	4	4,680	20.60	21.24	21.92	22.65	No Interference
※ HGLB 2020-250		25				60	4	6,480	25.76	26.56	27.42	28.34	No Interference
※ HGLB 2020-300		30				70	4	7,320	30.92	31.89	32.93	No Interference	No Interference
HGLB 2030-060		R1.5				6	2.4	2.95	16°	60	6	4,680	6.20
HGLB 2030-080	8		60	6	4,680	8.26				8.48	8.72	8.97	9.54
HGLB 2030-100	10		60	6	5,400	10.32				10.61	10.92	11.25	11.99
HGLB 2030-120	12		60	6	5,640	12.38				12.74	13.12	13.53	14.43
HGLB 2030-140	14		60	6	6,240	14.45				14.87	15.32	15.80	16.88
HGLB 2030-160	16		60	6	6,240	16.51				17.00	17.52	18.08	19.33
※ HGLB 2030-180	18		60	6	6,280	18.57				19.13	19.72	20.36	21.78
HGLB 2030-200	20		70	6	6,000	20.64				21.26	21.92	22.64	24.22
※ HGLB 2030-220	22		70	6	6,040	22.70				23.39	24.12	24.91	26.67
HGLB 2030-250	25		70	6	6,000	25.79				26.58	27.43	28.33	30.34
※ HGLB 2030-270	27		70	6	6,040	27.86				28.71	29.63	30.61	No Interference
※ HGLB 2030-300	30		70	6	6,840	30.95				31.91	32.93	34.02	No Interference

※Additional model



Unit (mm)

Model Number	Radius of Ball Nose R	Effective Length l_1	Length of Cut l	Neck Diameter ϕd_1	Shank Taper Angle β	Overall Length L	Shank Diameter ϕd	Price ¥	Effective Length by Inclined Angles				
									30°	1°	1°30'	2°	3°
HGLB 2040-080	R2	8	3.2	3.95	16°	70	6	4,800	8.24	8.45	8.67	8.90	9.43
HGLB 2040-100		10				70	6	4,800	10.31	10.58	10.87	11.18	11.88
HGLB 2040-120		12				70	6	6,240	12.37	12.71	13.07	13.46	14.32
HGLB 2040-140		14				70	6	6,240	14.43	14.84	15.27	15.74	16.77
HGLB 2040-160		16				70	6	6,240	16.49	16.97	17.47	18.01	19.22
※ HGLB 2040-180		18				70	6	6,380	18.56	19.10	19.67	20.29	No Interference
HGLB 2040-200		20				70	6	6,240	20.62	21.23	21.87	22.57	No Interference
※ HGLB 2040-220		22				70	6	6,380	22.68	23.36	24.08	24.85	No Interference
HGLB 2040-250		25				70	6	6,240	25.78	26.55	27.38	28.26	No Interference
※ HGLB 2040-270		27				70	6	6,380	27.84	28.68	29.58	30.54	No Interference
HGLB 2040-300		30				70	6	6,240	30.93	31.87	32.88	No Interference	No Interference
HGLB 2040-350		35				80	6	7,200	36.09	37.20	38.38	No Interference	No Interference
※ HGLB 2040-400		40				90	6	8,040	41.25	42.52	No Interference	No Interference	No Interference
HGLB 2060-100		R3				10	4.8	5.95	—	80	6	7,800	No Interference
HGLB 2060-150	15		80	6	7,800	No Interference				No Interference	No Interference	No Interference	No Interference
※ HGLB 2060-180	18		80	6	7,890	No Interference				No Interference	No Interference	No Interference	No Interference
HGLB 2060-200	20		80	6	7,800	No Interference				No Interference	No Interference	No Interference	No Interference
HGLB 2060-250	25		80	6	7,800	No Interference				No Interference	No Interference	No Interference	No Interference
HGLB 2060-300	30		80	6	8,040	No Interference				No Interference	No Interference	No Interference	No Interference
※ HGLB 2060-350	35		80	6	8,040	No Interference				No Interference	No Interference	No Interference	No Interference
※ HGLB 2060-400	40		90	6	8,760	No Interference				No Interference	No Interference	No Interference	No Interference
※ HGLB 2060-500	50		120	6	9,480	No Interference				No Interference	No Interference	No Interference	No Interference

※Additional model

UDC Series

CBN Series

Square
Long Neck Square

Radius

Long Neck Radius
Taper Neck Radius

Ball / Long Shank Ball

Long Neck Ball
Taper Neck Ball

Taper

Spiral V Cutter

Drill

EURO Series

Technical Data

Milling Conditions for HGLB

WORK MATERIAL		PREHARDENED STEELS HARDENED STEELS NAK / STAVAX (~55HRC)					HARDENED STEELS SKD11 (55~62HRC)				HARDENED STEELS HAP10 (62~66HRC)				HARDENED STEELS HAP72 (66~70HRC)			
Model Number	Radius of Ball Nose (mm)	Effective Length (mm)	Spindle Speed (min ⁻¹)	Feed Rate (mm/min)	a _p Axial Depth (mm)	a _e Radial Depth (mm)	Spindle Speed (min ⁻¹)	Feed Rate (mm/min)	a _p Axial Depth (mm)	a _e Radial Depth (mm)	Spindle Speed (min ⁻¹)	Feed Rate (mm/min)	a _p Axial Depth (mm)	a _e Radial Depth (mm)	Spindle Speed (min ⁻¹)	Feed Rate (mm/min)	a _p Axial Depth (mm)	a _e Radial Depth (mm)
2001-002	R0.05	0.2	48,000	200	0.005	0.01	48,000	200	0.005	0.01	48,000	150	0.003	0.006	40,000	120	0.002	0.004
2001-003		0.3	48,000	200	0.005	0.01	48,000	200	0.005	0.01	48,000	150	0.003	0.006	40,000	120	0.002	0.004
2001-005		0.5	48,000	200	0.005	0.01	48,000	200	0.005	0.01	48,000	150	0.003	0.006	40,000	120	0.002	0.004
20015-003	R0.075	0.3	48,000	230	0.007	0.014	48,000	230	0.007	0.014	48,000	170	0.005	0.01	40,000	135	0.003	0.006
20015-005		0.5	48,000	230	0.007	0.014	48,000	230	0.007	0.014	48,000	170	0.005	0.01	40,000	135	0.003	0.006
20015-0075		0.75	48,000	230	0.007	0.014	48,000	230	0.007	0.014	48,000	170	0.005	0.01	40,000	135	0.003	0.006
20015-010	R0.1	1	38,400	160	0.005	0.01	38,400	160	0.005	0.01	38,400	120	0.003	0.007	32,000	90	0.002	0.004
2002-003		0.3	44,000	250	0.01	0.03	42,000	250	0.01	0.03	40,000	200	0.008	0.024	36,000	150	0.006	0.018
2002-005		0.5	44,000	250	0.01	0.03	42,000	250	0.01	0.03	40,000	200	0.008	0.024	36,000	150	0.006	0.018
2002-0075		0.75	44,000	250	0.01	0.03	42,000	250	0.01	0.03	40,000	200	0.008	0.024	36,000	150	0.006	0.018
2002-010		1	44,000	250	0.01	0.03	42,000	250	0.01	0.03	40,000	200	0.008	0.024	36,000	150	0.006	0.018
2002-015		1.5	35,200	175	0.008	0.023	33,600	175	0.008	0.023	32,000	140	0.006	0.018	28,800	100	0.004	0.012
2002-020	2	35,200	120	0.003	0.008	33,600	100	0.003	0.008	32,000	90	0.003	0.008	28,800	70	0.002	0.006	
2003-005	R0.15	0.5	44,000	400	0.01	0.03	42,000	350	0.01	0.03	40,000	300	0.01	0.03	36,000	250	0.008	0.024
2003-0075		0.75	44,000	400	0.01	0.03	42,000	350	0.01	0.03	40,000	300	0.01	0.03	36,000	250	0.008	0.024
2003-010		1	44,000	400	0.01	0.03	42,000	350	0.01	0.03	40,000	300	0.01	0.03	36,000	250	0.008	0.024
2003-015		1.5	44,000	400	0.01	0.03	42,000	350	0.01	0.03	40,000	300	0.01	0.03	36,000	250	0.008	0.024
2003-020		2	35,200	280	0.008	0.023	33,600	245	0.008	0.023	32,000	210	0.008	0.023	28,800	175	0.006	0.018
2003-025		2.5	35,200	185	0.006	0.017	33,600	165	0.006	0.017	32,000	150	0.006	0.017	28,800	115	0.005	0.014
2003-030	3	35,200	140	0.004	0.01	33,600	125	0.004	0.01	32,000	110	0.004	0.01	28,800	85	0.003	0.009	
2004-005	R0.2	0.5	44,000	600	0.015	0.045	42,000	550	0.015	0.045	40,000	500	0.013	0.036	36,000	350	0.01	0.027
2004-0075		0.75	44,000	600	0.015	0.045	42,000	550	0.015	0.045	40,000	500	0.013	0.036	36,000	350	0.01	0.027
2004-010		1	44,000	600	0.015	0.045	42,000	550	0.015	0.045	40,000	500	0.013	0.036	36,000	350	0.01	0.027
2004-0125		1.25	44,000	600	0.015	0.045	42,000	550	0.015	0.045	40,000	500	0.013	0.036	36,000	350	0.01	0.027
2004-015		1.5	44,000	600	0.015	0.045	42,000	550	0.015	0.045	40,000	500	0.013	0.036	36,000	350	0.01	0.027
2004-020		2	44,000	600	0.015	0.045	42,000	550	0.015	0.045	40,000	500	0.013	0.036	36,000	350	0.01	0.027
2004-025		2.5	35,200	420	0.011	0.034	33,600	385	0.011	0.034	32,000	350	0.01	0.027	28,800	250	0.008	0.02
2004-030		3	35,200	330	0.008	0.024	33,600	310	0.008	0.024	32,000	280	0.008	0.022	28,800	200	0.006	0.016
2004-035	3.5	35,200	300	0.007	0.022	31,900	280	0.007	0.022	30,400	250	0.007	0.02	26,600	175	0.005	0.014	
2004-040	4	35,200	270	0.006	0.019	30,240	250	0.006	0.019	28,800	220	0.006	0.018	25,200	150	0.004	0.012	
2005-010	R0.25	1	44,000	900	0.02	0.065	40,000	800	0.015	0.05	36,000	600	0.015	0.05	30,000	400	0.015	0.03
2005-015		1.5	44,000	900	0.02	0.065	40,000	800	0.015	0.05	36,000	600	0.015	0.05	30,000	400	0.015	0.03
2005-020		2	44,000	900	0.02	0.065	40,000	800	0.015	0.05	36,000	600	0.015	0.05	30,000	400	0.015	0.03
2005-025		2.5	44,000	900	0.02	0.065	40,000	800	0.015	0.05	36,000	600	0.015	0.05	30,000	400	0.015	0.03
2005-030		3	32,700	450	0.01	0.04	31,500	400	0.01	0.03	30,000	300	0.008	0.03	24,000	200	0.007	0.015
2005-035		3.5	32,700	450	0.01	0.04	31,500	400	0.01	0.03	30,000	300	0.008	0.03	24,000	200	0.007	0.015
2005-040		4	32,700	450	0.01	0.04	31,500	400	0.01	0.03	30,000	300	0.008	0.03	24,000	200	0.007	0.015
2005-045		4.5	29,430	405	0.008	0.03	28,350	360	0.008	0.025	27,000	270	0.006	0.025	21,600	180	0.005	0.013
2005-050		5	26,160	360	0.005	0.02	25,200	320	0.005	0.02	24,000	240	0.004	0.02	19,200	160	0.003	0.01
2005-060		6	26,160	360	0.005	0.02	25,200	320	0.005	0.02	24,000	240	0.004	0.02	19,200	160	0.003	0.01

UDC Series

CBN Series

Square

Long Neck Square

Radius

Long Neck Radius

Taper Neck Radius

Ball / Long Shank Ball

Long Neck Ball

Taper Neck Ball

Taper

Spiral V Cutter

Drill

EURO Series

Technical Data

Milling Conditions for HGLB

WORK MATERIAL			PREHARDENED STEELS HARDENED STEELS NAK / STAVAX (~55HRC)				HARDENED STEELS SKD11 (55~62HRC)				HARDENED STEELS HAP10 (62~66HRC)				HARDENED STEELS HAP72 (66~70HRC)			
Model Number	Radius of Ball Nose (mm)	Effective Length (mm)	Spindle Speed (min ⁻¹)	Feed Rate (mm/min)	a _p Axial Depth (mm)	a _e Radial Depth (mm)	Spindle Speed (min ⁻¹)	Feed Rate (mm/min)	a _p Axial Depth (mm)	a _e Radial Depth (mm)	Spindle Speed (min ⁻¹)	Feed Rate (mm/min)	a _p Axial Depth (mm)	a _e Radial Depth (mm)	Spindle Speed (min ⁻¹)	Feed Rate (mm/min)	a _p Axial Depth (mm)	a _e Radial Depth (mm)
2006-010	R0.3	1	40,000	1,400	0.045	0.15	36,000	1,500	0.03	0.13	32,000	1,000	0.02	0.1	25,000	600	0.02	0.1
2006-015		1.5	40,000	1,400	0.03	0.13	36,000	1,300	0.03	0.13	32,000	1,000	0.02	0.1	25,000	600	0.02	0.1
2006-020		2	40,000	1,400	0.03	0.13	36,000	1,300	0.03	0.13	32,000	1,000	0.02	0.1	25,000	600	0.02	0.1
2006-025		2.5	40,000	1,200	0.025	0.1	36,000	1,100	0.025	0.1	32,000	900	0.02	0.1	25,000	500	0.02	0.1
2006-030		3	40,000	1,200	0.025	0.1	36,000	1,100	0.025	0.1	32,000	900	0.02	0.1	25,000	500	0.02	0.1
2006-035		3.5	40,000	1,100	0.023	0.09	34,000	950	0.023	0.09	32,000	800	0.018	0.09	25,000	450	0.015	0.09
2006-040		4	40,000	1,000	0.02	0.08	32,000	800	0.02	0.08	32,000	700	0.015	0.07	25,000	400	0.01	0.075
2006-045		4.5	32,000	600	0.01	0.07	28,000	600	0.01	0.05	25,600	500	0.01	0.05	20,000	300	0.005	0.05
2006-050		5	32,000	600	0.01	0.07	28,000	600	0.01	0.05	25,600	500	0.01	0.05	20,000	300	0.005	0.05
2006-055		5.5	32,000	600	0.01	0.07	28,000	600	0.01	0.05	25,600	500	0.01	0.05	20,000	300	0.005	0.05
2006-060	6	32,000	600	0.01	0.07	28,000	600	0.01	0.05	25,600	500	0.01	0.05	20,000	300	0.005	0.05	
2006-080	8	25,600	480	0.008	0.02	22,400	480	0.008	0.02	20,480	350	0.007	0.02	16,000	210	0.004	0.01	
2006-100	10	20,480	390	0.006	0.02	17,920	390	0.006	0.02	16,400	250	0.005	0.02	12,800	150	0.003	0.01	
2008-020	R0.4	2	35,000	1,600	0.06	0.21	30,000	1,600	0.04	0.17	26,000	1,350	0.04	0.15	20,000	700	0.02	0.12
2008-025		2.5	35,000	1,600	0.06	0.21	30,000	1,600	0.04	0.17	26,000	1,350	0.04	0.15	20,000	700	0.02	0.12
2008-030		3	35,000	1,600	0.06	0.21	30,000	1,600	0.04	0.17	26,000	1,350	0.04	0.15	20,000	700	0.02	0.12
2008-040		4	35,000	1,600	0.06	0.21	30,000	1,600	0.04	0.17	26,000	1,350	0.04	0.15	20,000	700	0.02	0.12
2008-050		5	31,500	1,300	0.04	0.17	27,500	1,300	0.03	0.15	23,400	1,000	0.03	0.11	18,000	530	0.015	0.09
2008-060		6	28,000	1,000	0.02	0.12	25,000	1,000	0.02	0.12	20,800	675	0.02	0.075	16,000	350	0.01	0.06
2008-070		7	25,200	900	0.02	0.11	22,500	900	0.02	0.11	18,700	600	0.018	0.068	14,400	330	0.009	0.05
2008-080		8	22,400	800	0.02	0.1	20,000	800	0.02	0.1	16,640	540	0.016	0.06	12,800	300	0.008	0.048
2010-020	R0.5	2	30,000	1,750	0.2	0.4	24,000	2,000	0.1	0.3	21,000	1,750	0.05	0.2	16,000	875	0.05	0.2
2010-025		2.5	30,000	1,750	0.2	0.4	24,000	2,000	0.1	0.3	21,000	1,750	0.05	0.2	16,000	875	0.05	0.2
2010-030		3	30,000	1,750	0.1	0.3	24,000	2,000	0.1	0.2	21,000	1,750	0.03	0.17	16,000	875	0.03	0.17
2010-040		4	30,000	1,750	0.1	0.3	24,000	2,000	0.1	0.2	21,000	1,750	0.03	0.17	16,000	875	0.03	0.17
2010-050		5	30,000	1,750	0.1	0.3	24,000	2,000	0.1	0.2	21,000	1,750	0.03	0.17	16,000	875	0.03	0.17
2010-060		6	30,000	1,150	0.06	0.23	21,500	1,250	0.03	0.17	19,700	1,050	0.025	0.15	14,500	525	0.025	0.15
2010-070		7	27,000	980	0.04	0.19	20,000	920	0.02	0.15	19,000	770	0.02	0.14	14,200	380	0.02	0.14
2010-080		8	24,000	800	0.025	0.155	18,500	580	0.015	0.12	18,400	480	0.015	0.12	13,800	240	0.015	0.12
2010-100		10	22,000	600	0.018	0.13	14,800	430	0.01	0.09	14,700	360	0.01	0.09	14,700	360	0.01	0.09
2010-120		12	14,150	320	0.015	0.12	13,400	380	0.008	0.08	13,300	290	0.008	0.08	13,300	290	0.008	0.08
2010-140	14	13,500	280	0.012	0.1	12,000	350	0.007	0.08	12,000	220	0.007	0.08	12,000	220	0.007	0.08	
2010-160	16	12,150	250	0.011	0.09	10,800	320	0.006	0.07	10,800	200	0.006	0.07	10,800	200	0.006	0.07	
2015-030	R0.75	3	30,000	2,450	0.25	0.55	17,000	2,000	0.12	0.4	15,000	1,750	0.06	0.29	11,250	875	0.06	0.29
2015-040		4	30,000	2,450	0.25	0.55	17,000	2,000	0.12	0.4	15,000	1,750	0.06	0.29	11,250	875	0.06	0.29
2015-060		6	30,000	2,450	0.15	0.45	17,000	2,000	0.07	0.31	15,000	1,750	0.04	0.24	11,250	875	0.04	0.24
2015-080		8	23,500	1,300	0.1	0.37	15,000	1,250	0.045	0.25	14,000	1,050	0.03	0.21	10,500	525	0.03	0.21
2015-100		10	23,500	1,300	0.1	0.37	15,000	1,250	0.045	0.25	14,000	1,050	0.03	0.21	10,500	525	0.03	0.21
2015-120		12	13,100	480	0.03	0.21	13,000	580	0.02	0.17	13,000	480	0.02	0.17	9,750	240	0.02	0.17
2015-140		14	11,200	400	0.025	0.19	10,900	490	0.015	0.145	10,900	390	0.015	0.145	8,200	190	0.015	0.145
2015-160		16	10,000	360	0.023	0.17	9,800	440	0.014	0.13	9,800	350	0.014	0.13	7,380	170	0.014	0.13
2015-200		20	8,900	320	0.02	0.15	8,700	390	0.012	0.12	8,700	310	0.012	0.12	6,560	150	0.012	0.12

- UDC Series
- CBN Series
- Square
- Long Neck Square
- Radius
- Long Neck Radius
- Taper Neck Radius
- Ball / Long Shark Ball
- Long Neck Ball
- Taper Neck Ball
- Taper
- Spiral V Cutter
- Drill
- EURO Series
- Technical Data

Milling Conditions for HGLB

WORK MATERIAL			PREHARDENED STEELS HARDENED STEELS NAK / STAVAX (~55HRC)				HARDENED STEELS SKD11 (55~62HRC)				HARDENED STEELS HAP10 (62~66HRC)				HARDENED STEELS HAP72 (66~70HRC)			
Model Number	Radius of Ball Nose (mm)	Effective Length (mm)	Spindle Speed (min ⁻¹)	Feed Rate (mm/min)	a _p Axial Depth (mm)	a _e Radial Depth (mm)	Spindle Speed (min ⁻¹)	Feed Rate (mm/min)	a _p Axial Depth (mm)	a _e Radial Depth (mm)	Spindle Speed (min ⁻¹)	Feed Rate (mm/min)	a _p Axial Depth (mm)	a _e Radial Depth (mm)	Spindle Speed (min ⁻¹)	Feed Rate (mm/min)	a _p Axial Depth (mm)	a _e Radial Depth (mm)
2020-030	R1	3	28,000	2,900	0.3	0.7	14,000	2,100	0.15	0.5	14,700	2,100	0.15	0.35	12,250	1,800	0.08	0.35
2020-040		4	28,000	2,900	0.3	0.7	14,000	2,100	0.15	0.5	14,700	2,100	0.15	0.35	12,250	1,800	0.08	0.35
2020-060		6	28,000	2,900	0.2	0.6	14,000	2,100	0.1	0.4	14,700	2,100	0.15	0.3	12,250	1,800	0.06	0.3
2020-080		8	28,000	2,900	0.2	0.6	14,000	2,100	0.1	0.4	14,700	2,100	0.15	0.3	12,250	1,800	0.06	0.3
2020-100		10	28,000	2,900	0.2	0.6	14,000	2,100	0.1	0.4	14,700	2,100	0.15	0.3	12,250	1,800	0.06	0.3
2020-120		12	19,500	1,350	0.12	0.45	12,400	1,350	0.06	0.34	13,800	1,320	0.09	0.27	11,500	1,100	0.045	0.27
2020-140		14	19,500	1,350	0.12	0.45	12,400	1,350	0.06	0.34	13,800	1,320	0.09	0.27	11,500	1,100	0.045	0.27
2020-160		16	10,800	500	0.05	0.3	10,800	600	0.03	0.24	12,840	588	0.06	0.24	10,700	490	0.03	0.24
2020-200		20	10,800	500	0.035	0.25	10,800	450	0.02	0.19	10,270	440	0.04	0.19	8,560	370	0.02	0.19
2020-250		25	9,720	450	0.032	0.23	9,720	410	0.018	0.17	9,250	400	0.036	0.17	7,700	330	0.018	0.17
2020-300		30	8,650	400	0.028	0.2	8,650	360	0.016	0.15	8,200	350	0.032	0.15	6,850	300	0.016	0.15
2030-060		R1.5	6	21,000	3,000	0.4	1	13,250	2,740	0.29	0.7	11,040	2,280	0.24	0.55	9,200	1,900	0.12
2030-080	8		21,000	3,000	0.4	1	13,250	2,740	0.29	0.7	11,040	2,280	0.24	0.55	9,200	1,900	0.12	0.55
2030-100	10		21,000	3,000	0.3	0.9	13,250	2,740	0.24	0.65	11,040	2,280	0.2	0.5	9,200	1,900	0.1	0.5
2030-120	12		21,000	3,000	0.3	0.9	13,250	2,740	0.24	0.65	11,040	2,280	0.2	0.5	9,200	1,900	0.1	0.5
2030-140	14		21,000	3,000	0.3	0.9	13,250	2,740	0.24	0.65	11,040	2,280	0.2	0.5	9,200	1,900	0.1	0.5
2030-160	16		21,000	3,000	0.3	0.9	13,250	2,740	0.24	0.65	11,040	2,280	0.2	0.5	9,200	1,900	0.1	0.5
2030-180	18		17,750	2,300	0.24	0.8	12,800	2,200	0.21	0.58	10,680	1,830	0.18	0.48	8,900	1,525	0.088	0.48
2030-200	20		14,500	1,600	0.18	0.7	12,380	1,660	0.18	0.5	10,320	1,380	0.15	0.45	8,600	1,150	0.075	0.45
2030-220	22		13,000	1,440	0.16	0.63	11,950	1,200	0.15	0.44	9,960	1,000	0.13	0.42	8,300	830	0.063	0.42
2030-250	25		11,600	1,280	0.14	0.56	11,520	730	0.12	0.38	9,600	610	0.1	0.38	8,000	510	0.05	0.38
2030-270	27		10,500	1,150	0.13	0.51	9,850	630	0.1	0.34	8,200	530	0.08	0.34	6,850	440	0.04	0.34
2030-300	30		9,280	1,020	0.11	0.45	8,200	530	0.07	0.29	6,840	440	0.06	0.29	5,700	370	0.03	0.29
2040-080	R2	8	18,000	3,200	0.5	1.3	11,380	2,880	0.36	0.95	9,480	2,400	0.3	0.75	7,900	2,000	0.15	0.75
2040-100		10	18,000	3,200	0.5	1.3	11,380	2,880	0.36	0.95	9,480	2,400	0.3	0.75	7,900	2,000	0.15	0.75
2040-120		12	18,000	3,200	0.4	1.2	11,380	2,880	0.31	0.85	9,480	2,400	0.26	0.7	7,900	2,000	0.13	0.7
2040-140		14	18,000	3,200	0.4	1.2	11,380	2,880	0.31	0.85	9,480	2,400	0.26	0.7	7,900	2,000	0.13	0.7
2040-160		16	18,000	3,200	0.4	1.2	11,380	2,880	0.31	0.85	9,480	2,400	0.26	0.7	7,900	2,000	0.13	0.7
2040-180		18	18,000	3,200	0.4	1.2	11,380	2,880	0.31	0.85	9,480	2,400	0.26	0.7	7,900	2,000	0.13	0.7
2040-200		20	18,000	3,200	0.4	1.2	10,730	1,800	0.21	0.7	8,940	1,500	0.18	0.55	7,450	1,250	0.09	0.55
2040-220		22	15,250	2,250	0.33	1.1	10,730	1,800	0.21	0.7	8,940	1,500	0.18	0.55	7,450	1,250	0.09	0.55
2040-250		25	12,500	1,250	0.25	0.95	10,730	1,800	0.21	0.7	8,940	1,500	0.18	0.55	7,450	1,250	0.09	0.55
2040-270		27	11,500	1,150	0.23	0.9	10,400	1,250	0.18	0.58	8,670	1,050	0.15	0.5	7,250	890	0.075	0.5
2040-300		30	10,630	1,000	0.2	0.76	10,080	780	0.15	0.45	8,400	650	0.12	0.45	7,000	540	0.06	0.45
2040-350		35	9,030	800	0.16	0.61	8,640	730	0.13	0.43	7,200	610	0.11	0.43	6,000	510	0.055	0.43
2040-400	40	8,300	700	0.14	0.54	8,000	700	0.12	0.42	6,650	590	0.11	0.42	5,500	500	0.05	0.42	
2060-100	R3	10	14,400	3,200	0.5	1.5	9,140	2,880	0.38	1.05	7,620	2,400	0.32	0.88	6,350	2,000	0.16	0.88
2060-150		15	14,400	3,200	0.5	1.5	9,140	2,880	0.38	1.05	7,620	2,400	0.32	0.88	6,350	2,000	0.16	0.88
2060-180		18	14,400	3,200	0.5	1.5	9,140	2,880	0.38	1.05	7,620	2,400	0.32	0.88	6,350	2,000	0.16	0.88
2060-200		20	14,400	3,200	0.5	1.5	9,000	2,300	0.32	0.95	7,620	2,400	0.32	0.88	6,350	2,000	0.16	0.88
2060-250		25	14,400	3,200	0.5	1.5	8,100	2,000	0.3	0.95	7,500	1,920	0.27	0.805	6,250	1,600	0.135	0.805
2060-300		30	14,400	3,200	0.5	1.5	7,700	1,800	0.26	0.88	7,440	1,500	0.22	0.73	6,200	1,250	0.11	0.73
2060-350		35	9,200	2,050	0.32	1	6,200	1,450	0.21	0.71	6,000	1,200	0.18	0.59	5,000	1,000	0.09	0.59
2060-400		40	7,000	1,050	0.2	0.8	5,600	1,000	0.19	0.64	4,800	950	0.14	0.47	4,000	810	0.07	0.47
2060-500		50	5,600	850	0.16	0.6	4,500	810	0.15	0.52	3,900	780	0.12	0.38	3,200	650	0.06	0.38

UDC Series

CBN Series

Square

Square

Long Neck Square

Radius

Radius

Long Neck Radius

Taper Neck Radius

Ball / Long Shank Ball

Ball

Long Neck Ball

Taper Neck Ball

Taper

Taper

Spiral V Cutter

Drill

EURO Series

Technical Data

a_p : Axial Depth (mm)
 a_e : Radial Depth (mm)

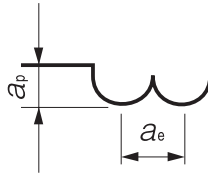

Note:

- Decrease the feed rate more than 50% from the milling parameters when slot milling.
- Decrease both spindle speed and feed rate proportionally when the milling parameters exceed the machines maximum speed, or when the tool is chattering and heats up to a red color.
- Every coolant offers stable milling.

UDC Series

CBN Series

Square

Long Neck Square

Radius

Long Neck Radius

Taper Neck Radius

Ball / Long Shank Ball

Long Neck Ball

Taper Neck Ball

Taper

Spiral V Cutter

Drill

EURO Series

Technical Data

Wear Comparison HGLB R1 × Effective Length 6 HAP72 (69HRC)

Tools after milling

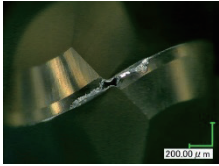

Conventional

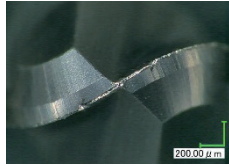

HGLB

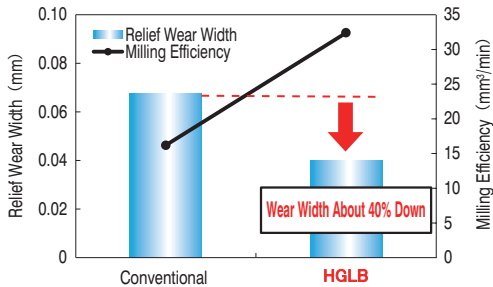

HGLB mills twice as efficient as the conventional tool.

Tool	Conventional	HGLB 2020-060
Spindle Speed	9,200 min ⁻¹	12,250 min ⁻¹
Feed Rate	900 mm/min	1,800 mm/min
Axial Depth a_p	0.06 mm	
Radial Depth a_e	0.3 mm	
Coolant	Air Blow (Through Spindle)	
Milling Shape	Square Pocket (20 x 15 x Depth 2 mm) × 2 Pockets	
Cycle Time	76 min	50 min

$$\text{Milling Efficiency (mm}^3\text{/min)} = \text{Feed Rate} \times a_p \times a_e$$

* Refer to page 581 for tool geometry, and page 582 for milling examples.

UDC Series

CBN Series

Square
Long Neck Square

Radius

Radius
Long Neck Radius

Taper Neck Radius

Ball / Long Shank Ball

Ball
Long Neck Ball

Taper Neck Ball

Taper

Spiral V Cutter

Drill

EURO Series

Technical Data



Size R0.05~R3

HSLB

Super
MG

HARD
MAX

Shank Dia
0/-0.005

Back Taper
Geometry

~Except for R0.45
 $\ell_1 / D \leq 10$

Material Applications (☆ Highly Recommended ○ Recommended ○ Suggested)

Work Material															
Carbon Steels S45C S55C	Alloy Steels SK / SCM SUS	Prehardened Steels NAK HPM	Hardened Steels			Cast Iron	Aluminum Alloys	Graphite	Copper	Plastics	Glass Filled Plastics	Titanium Alloys	Heat Resistant Alloys	Cemented Carbide	Hard Brittle (Non-Metallic) Materials
			~55HRC	~60HRC	~70HRC										
○	○	○	○	○	○	○			○			○	○		

Features

High efficiency, long tool life and excellent surface finish on material 40HRC or harder.

HARDMAX coat offers heat resistance, durability and lubricity at a high level.

Every coolant offers stable milling.

Ball tip radius point is designed with a negative rake angle that minimizes wear and improves the target dimensions.

The low negative rake angle at the peripheral side of the ball offers an excellent surface finish and prevents deflection.

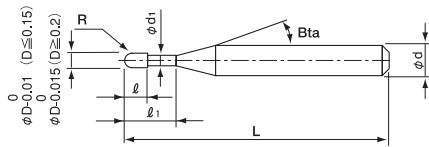

The shank taper angle shown is not an exact value and to avoid contact with the work piece, we recommend the user controls the precise value of this angle. Shank taper angle should not make contact with the work piece.

Radius of Ball Nose	Diameter Tolerance	Ball Radius Accuracy	Helix Angle
R0.05 ~ R0.075	0/-0.01	±0.002	0°
R0.1 ~ R3	0/-0.015	±0.005	30°

Total 325 models

Unit (mm)

Model Number	Radius of Ball Nose R	Effective Length ℓ_1	Length of Cut ℓ	Neck Diameter ϕd_1	Shank Taper Angle Bta	Overall Length L	Shank Diameter ϕd	Price ¥	Effective Length by Inclined Angles				
									30°	1°	1°30'	2°	3°
HSLB 2001-002	R0.05	0.2	0.08	0.095	11°	45	4	11,630	0.21	0.23	0.25	0.27	0.31
HSLB 2001-003		0.3							0.32	0.35	0.37	0.40	0.45
HSLB 2001-005		0.5							0.54	0.57	0.61	0.64	0.72
HSLB 20015-003	R0.075	0.3	0.12	0.135	11°	45	4	13,450	0.36	0.38	0.40	0.42	0.47
HSLB 20015-005		0.5							0.57	0.60	0.63	0.67	0.75
HSLB 20015-010		1							1.10	1.15	1.21	1.27	1.43

Model Number	Radius of Ball Nose R	Effective Length l_1	Length of Cut l	Neck Diameter ϕd_1	Shank Taper Angle Bta	Overall Length L	Shank Diameter ϕd	Price ¥	Effective Length by Inclined Angles				
									30°	1°	1°30'	2°	3°
HSLB 2002-003	RO.1	0.3	0.16	0.19	16°	45	4	8,090	0.39	0.42	0.44	0.46	0.50
HSLB 2002-005		0.5				45	4	8,090	0.61	0.64	0.66	0.69	0.74
HSLB 2002-005-6		0.5				50	6	11,290	0.61	0.64	0.66	0.69	0.74
HSLB 2002-0075		0.75				45	4	8,090	0.87	0.91	0.95	0.98	1.05
HSLB 2002-010		1				45	4	8,090	1.13	1.18	1.22	1.26	1.35
HSLB 2002-010-6		1				50	6	11,290	1.13	1.18	1.22	1.26	1.35
HSLB 2002-0125		1.25				45	4	8,780	1.38	1.44	1.49	1.54	1.65
HSLB 2002-015		1.5				45	4	8,780	1.64	1.71	1.76	1.82	1.96
HSLB 2002-015-6		1.5				50	6	12,250	1.64	1.71	1.76	1.82	1.96
HSLB 2002-0175		1.75				45	4	9,690	1.90	1.97	2.04	2.11	2.26
HSLB 2002-020		2				45	4	9,690	2.16	2.24	2.31	2.39	2.57
HSLB 2002-020-6		2				50	6	13,520	2.16	2.24	2.31	2.39	2.57
HSLB 2002-0225		2.25				45	4	10,600	2.42	2.51	2.59	2.68	2.87
HSLB 2002-025		2.5				45	4	10,600	2.68	2.77	2.86	2.96	3.18
HSLB 2002-030		3				45	4	11,400	3.20	3.30	3.41	3.53	3.79
HSLB 2003-005	RO.15	0.5	0.24	0.29	16°	45	4	7,980	0.60	0.63	0.66	0.68	0.73
HSLB 2003-006		0.6				45	4	7,980	0.71	0.74	0.77	0.80	0.85
HSLB 2003-0075		0.75				45	4	7,980	0.87	0.91	0.94	0.97	1.04
HSLB 2003-010		1				45	4	7,980	1.13	1.18	1.22	1.26	1.34
HSLB 2003-010-6		1				50	6	10,830	1.13	1.18	1.22	1.26	1.34
HSLB 2003-0125		1.25				45	4	8,550	1.38	1.43	1.48	1.53	1.64
HSLB 2003-015		1.5				45	4	8,550	1.64	1.70	1.76	1.82	1.94
HSLB 2003-015-6		1.5				50	6	11,860	1.64	1.70	1.76	1.82	1.94
HSLB 2003-0175		1.75				45	4	8,550	1.90	1.97	2.03	2.10	2.25
HSLB 2003-020		2				45	4	8,550	2.16	2.24	2.31	2.38	2.56
HSLB 2003-020-6		2				50	6	11,860	2.16	2.24	2.31	2.38	2.56
HSLB 2003-0225		2.25				45	4	8,780	2.42	2.50	2.58	2.67	2.86
HSLB 2003-025		2.5				45	4	8,780	2.68	2.77	2.86	2.95	3.17
HSLB 2003-030		3				45	4	8,780	3.20	3.30	3.41	3.52	3.78
HSLB 2003-040		4				45	4	9,120	4.23	4.37	4.51	4.66	5.00
HSLB 2003-050	5	45	4	10,260	5.26	5.43	5.61	5.80	6.23				
HSLB 2004-005	RO.2	0.5	0.32	0.39	16°	45	4	5,470	0.60	0.63	0.65	0.68	0.72
HSLB 2004-0075		0.75				45	4	5,470	0.86	0.90	0.93	0.96	1.03
HSLB 2004-010		1				45	4	5,470	1.13	1.17	1.21	1.25	1.33
HSLB 2004-010-6		1				50	6	7,980	1.13	1.17	1.21	1.25	1.33
HSLB 2004-0125		1.25				45	4	5,590	1.37	1.43	1.48	1.52	1.63
HSLB 2004-015		1.5				45	4	5,590	1.64	1.70	1.75	1.81	1.93
HSLB 2004-015-6		1.5				50	6	8,090	1.64	1.70	1.75	1.81	1.93
HSLB 2004-0175		1.75				45	4	5,700	1.90	1.97	2.03	2.09	2.24
HSLB 2004-020		2				45	4	5,700	2.16	2.23	2.30	2.38	2.55
HSLB 2004-020-6		2				50	6	8,320	2.16	2.23	2.30	2.38	2.55
HSLB 2004-0225		2.25				45	4	5,930	2.42	2.50	2.58	2.66	2.85
HSLB 2004-025		2.5				45	4	5,930	2.68	2.76	2.85	2.95	3.16
HSLB 2004-025-6		2.5				50	6	8,550	2.68	2.76	2.85	2.95	3.16
HSLB 2004-030		3				45	4	6,270	3.20	3.30	3.40	3.52	3.77
HSLB 2004-030-6		3				50	6	9,120	3.20	3.30	3.40	3.52	3.77
HSLB 2004-035	3.5	45	4	6,840	3.71	3.83	3.95	4.09	4.38				
HSLB 2004-040	4	45	4	6,840	4.23	4.36	4.50	4.66	4.99				
HSLB 2004-040-6	4	50	6	9,300	4.23	4.36	4.50	4.66	4.99				
HSLB 2004-045	4.5	45	4	7,180	4.74	4.89	5.05	5.22	5.61				
HSLB 2004-050	5	45	4	7,180	5.26	5.43	5.60	5.79	6.22				
HSLB 2004-060	6	45	4	8,320	6.29	6.49	6.70	6.93	7.44				

- UDC Series
- CBN Series
- Square
- Long Neck Square
- Radius
- Long Neck Radius
- Taper Neck Radius
- Ball / Long Shank Ball
- Long Neck Ball
- Taper Neck Ball
- Taper
- Spiral V Cutter
- Drill
- EURO Series
- Technical Data

Model Number	Radius of Ball Nose R	Effective Length l_1	Length of Cut l	Neck Diameter ϕd_1	Shank Taper Angle Bia	Overall Length L	Shank Diameter ϕd	Price ¥	Effective Length by Inclined Angles				
									30°	1°	1°30'	2°	3°
HSLB 2005-010	R0.25	1	0.4	0.49	16°	45	4	5,470	1.12	1.17	1.21	1.24	1.32
HSLB 2005-0125		1.25				45	4	5,470	1.37	1.43	1.47	1.52	1.62
HSLB 2005-015		1.5				45	4	5,470	1.63	1.70	1.75	1.80	1.92
HSLB 2005-015-6		1.5				50	6	7,980	1.63	1.70	1.75	1.80	1.92
HSLB 2005-0175		1.75				45	4	5,470	1.90	1.96	2.02	2.09	2.23
HSLB 2005-020		2				45	4	5,470	2.16	2.23	2.30	2.37	2.54
HSLB 2005-020-6		2				50	6	7,980	2.16	2.23	2.30	2.37	2.54
HSLB 2005-0225		2.25				45	4	5,470	2.42	2.50	2.57	2.66	2.84
HSLB 2005-025		2.5				45	4	5,470	2.68	2.76	2.85	2.94	3.15
HSLB 2005-025-6		2.5				50	6	7,980	2.68	2.76	2.85	2.94	3.15
HSLB 2005-030		3				45	4	5,470	3.20	3.29	3.40	3.51	3.76
HSLB 2005-030-6		3				50	6	7,980	3.20	3.29	3.40	3.51	3.76
HSLB 2005-035		3.5				45	4	5,470	3.71	3.83	3.95	4.08	4.37
HSLB 2005-040		4				45	4	5,470	4.23	4.36	4.50	4.65	4.98
HSLB 2005-040-6		4				50	6	7,980	4.23	4.36	4.50	4.65	4.98
HSLB 2005-045		4.5				45	4	5,590	4.74	4.89	5.05	5.22	5.59
HSLB 2005-050		5				45	4	5,590	5.26	5.42	5.60	5.79	6.21
HSLB 2005-055		5.5				45	4	5,700	5.77	5.96	6.15	6.36	6.82
HSLB 2005-060		6				45	4	5,700	6.29	6.49	6.70	6.93	7.43
HSLB 2005-070		7				45	4	6,840	7.32	7.55	7.80	8.06	8.65
HSLB 2005-080	8	45	4	6,840	8.35	8.62	8.90	9.20	9.88				
HSLB 2005-090	9	45	4	7,980	9.38	9.68	10.00	10.34	11.10				
HSLB 2005-100	10	50	4	8,500	10.42	10.75	11.10	11.48	12.32				
HSLB 2006-010	R0.3	1	0.48	0.59	16°	45	4	4,670	1.12	1.16	1.20	1.24	1.31
HSLB 2006-0125		1.25				45	4	4,220	1.37	1.42	1.47	1.51	1.61
HSLB 2006-015		1.5				45	4	4,220	1.63	1.69	1.74	1.80	1.91
HSLB 2006-015-6		1.5				50	6	6,380	1.63	1.69	1.74	1.80	1.91
HSLB 2006-0175		1.75				45	4	4,220	1.89	1.96	2.02	2.08	2.22
HSLB 2006-020		2				45	4	4,220	2.15	2.23	2.29	2.36	2.52
HSLB 2006-020-6		2				50	6	6,380	2.15	2.23	2.29	2.36	2.52
HSLB 2006-0225		2.25				45	4	4,330	2.42	2.49	2.57	2.65	2.83
HSLB 2006-025		2.5				45	4	4,330	2.67	2.76	2.84	2.93	3.14
HSLB 2006-025-6		2.5				50	6	6,380	2.67	2.76	2.84	2.93	3.14
HSLB 2006-030		3				45	4	4,330	3.19	3.29	3.39	3.50	3.75
HSLB 2006-030-6		3				50	6	6,500	3.19	3.29	3.39	3.50	3.75
HSLB 2006-035		3.5				45	4	4,450	3.71	3.82	3.94	4.07	4.36
HSLB 2006-040		4				45	4	4,450	4.23	4.36	4.49	4.64	4.97
HSLB 2006-040-6		4				50	6	6,730	4.23	4.36	4.49	4.64	4.97
HSLB 2006-045		4.5				45	4	4,450	4.74	4.89	5.04	5.21	5.58
HSLB 2006-050		5				45	4	4,450	5.26	5.42	5.59	5.78	6.20
HSLB 2006-050-6		5				50	6	6,730	5.26	5.42	5.59	5.78	6.20
HSLB 2006-055		5.5				45	4	4,450	5.77	5.95	6.14	6.35	6.81
HSLB 2006-060		6				45	4	4,450	6.29	6.49	6.69	6.92	7.42
HSLB 2006-060-6	6	50	6	6,730	6.29	6.49	6.69	6.92	7.42				
HSLB 2006-065	6.5	45	4	5,020	6.80	7.02	7.25	7.49	8.03				
HSLB 2006-070	7	45	4	5,020	7.32	7.55	7.80	8.06	8.64				
HSLB 2006-080	8	45	4	5,930	8.35	8.61	8.90	9.20	9.87				
HSLB 2006-080-6	8	50	6	8,550	8.35	8.61	8.90	9.20	9.87				
HSLB 2006-090	9	45	4	6,270	9.38	9.68	10.00	10.34	11.09				
HSLB 2006-100	10	50	4	6,040	10.41	10.74	11.10	11.47	12.31				
HSLB 2006-100-6	10	50	6	9,120	10.41	10.74	11.10	11.47	12.31				
HSLB 2006-120	12	50	4	6,840	12.48	12.87	13.30	13.75	14.76				

- UDC Series
- CBN Series
- Square
- Long Neck Square
- Radius
- Long Neck Radius
- Taper Neck Radius
- Ball / Long Shank Ball
- Long Neck Ball
- Taper Neck Ball
- Taper
- Spiral V Cutter
- Drill
- EURO Series
- Technical Data

Unit (mm)

Model Number	Radius of Ball Nose R	Effective Length l_1	Length of Cut l	Neck Diameter ϕd_1	Shank Taper Angle β	Overall Length L	Shank Diameter ϕd	Price ¥	Effective Length by Inclined Angles				
									30°	1°	1°30'	2°	3°
HSLB 2007-020	R0.35	2	0.56	0.69	16°	45	4	4,220	2.15	2.22	2.29	2.36	2.51
HSLB 2007-040		4				45	4	4,450	4.22	4.35	4.49	4.63	4.96
HSLB 2007-060		6				45	4	4,450	6.29	6.48	6.69	6.91	7.41
HSLB 2007-080		8				45	4	4,450	8.35	8.61	8.89	9.19	9.86
HSLB 2008-020	R0.4	2	0.64	0.79	16°	45	4	4,220	2.15	2.22	2.28	2.35	2.50
HSLB 2008-020-6		2				50	6	6,380	2.15	2.22	2.28	2.35	2.50
HSLB 2008-030		3				45	4	4,450	3.19	3.28	3.38	3.49	3.73
HSLB 2008-030-6		3				50	6	6,730	3.19	3.28	3.38	3.49	3.73
HSLB 2008-040		4				45	4	4,450	4.22	4.35	4.48	4.63	4.95
HSLB 2008-040-6		4				50	6	6,730	4.22	4.35	4.48	4.63	4.95
HSLB 2008-050		5				45	4	4,450	5.25	5.41	5.58	5.77	6.17
HSLB 2008-060		6				45	4	4,450	6.29	6.48	6.68	6.91	7.40
HSLB 2008-060-6		6				50	6	6,730	6.29	6.48	6.68	6.91	7.40
HSLB 2008-070		7				45	4	4,450	7.32	7.54	7.79	8.04	8.62
HSLB 2008-080		8				45	4	4,450	8.35	8.61	8.89	9.18	9.84
HSLB 2008-080-6		8				50	6	6,730	8.35	8.61	8.89	9.18	9.84
HSLB 2008-090		9				45	4	5,930	9.38	9.67	9.99	10.32	11.07
HSLB 2008-100		10				50	4	5,930	10.41	10.74	11.09	11.46	12.29
HSLB 2008-100-6		10				50	6	8,550	10.41	10.74	11.09	11.46	12.29
HSLB 2008-120		12				50	4	7,300	12.47	12.87	13.29	13.74	14.74
HSLB 2008-160	16	50	4	9,990	16.60	17.13	17.69	18.29	19.63				
HSLB 2009-020	R0.45	2	0.72	0.89	16°	45	4	4,220	2.15	2.22	2.28	2.34	2.49
HSLB 2009-040		4				45	4	4,450	4.22	4.35	4.48	4.62	4.94
HSLB 2009-060		6				45	4	4,450	6.28	6.48	6.68	6.90	7.39
HSLB 2009-080		8				45	4	4,450	8.35	8.61	8.88	9.18	9.83
HSLB 2009-100		10				45	4	5,930	10.41	10.73	11.08	11.45	12.28
HSLB 2009-120		12				50	4	7,300	12.47	12.86	13.28	13.73	14.73
HSLB 2009-140		14				50	4	8,460	14.54	14.99	15.48	16.01	17.18
HSLB 2009-160		16				50	4	9,990	16.60	17.12	17.68	18.29	19.62
HSLB 2009-180		18				55	4	9,990	18.66	19.25	19.89	20.56	22.07

Next Page →

UDC Series

CBN Series

Square

Long Neck Square

Radius

Long Neck Radius

Taper Neck Radius

Ball / Long Shank Ball

Long Neck Ball

Taper Neck Ball

Taper

Spiral V Cutter

Drill

EURO Series

Technical Data

Model Number	Radius of Ball Nose R	Effective Length l_1	Length of Cut l	Neck Diameter ϕd_1	Shank Taper Angle Bia	Overall Length L	Shank Diameter ϕd	Price ¥	Effective Length by Inclined Angles				
									30°	1°	1°30'	2°	3°
HSLB 2010-020	RO.5	2	0.8	0.98	16°	45	4	3,530	2.16	2.22	2.28	2.35	2.49
HSLB 2010-025		2.5				45	4	3,530	2.68	2.76	2.83	2.92	3.11
HSLB 2010-030		3				45	4	3,530	3.20	3.29	3.38	3.49	3.72
HSLB 2010-030-6		3				50	6	5,590	3.20	3.29	3.38	3.49	3.72
HSLB 2010-040		4				45	4	3,990	4.23	4.35	4.49	4.63	4.94
HSLB 2010-040-6		4				50	6	6,160	4.23	4.35	4.49	4.63	4.94
HSLB 2010-050		5				45	4	3,990	5.26	5.42	5.59	5.77	6.16
HSLB 2010-050-6		5				50	6	6,160	5.26	5.42	5.59	5.77	6.16
HSLB 2010-060		6				45	4	4,330	6.29	6.48	6.69	6.90	7.39
HSLB 2010-060-6		6				50	6	6,500	6.29	6.48	6.69	6.90	7.39
HSLB 2010-070		7				45	4	4,330	7.32	7.55	7.79	8.04	8.61
HSLB 2010-070-6		7				50	6	6,500	7.32	7.55	7.79	8.04	8.61
HSLB 2010-080		8				45	4	4,330	8.36	8.61	8.89	9.18	9.84
HSLB 2010-080-6		8				50	6	6,500	8.36	8.61	8.89	9.18	9.84
HSLB 2010-090		9				45	4	4,330	9.39	9.68	9.99	10.32	11.06
HSLB 2010-100		10				45	4	4,330	10.42	10.74	11.09	11.46	12.28
HSLB 2010-100-6		10				50	6	6,500	10.42	10.74	11.09	11.46	12.28
HSLB 2010-120		12				45	4	4,330	12.48	12.87	13.29	13.74	14.73
HSLB 2010-120-6		12				50	6	6,500	12.48	12.87	13.29	13.74	14.73
HSLB 2010-140		14				50	4	5,020	14.54	15.00	15.49	16.01	17.18
HSLB 2010-140-6	14	60	6	7,070	14.54	15.00	15.49	16.01	17.18				
HSLB 2010-160	16	50	4	5,930	16.61	17.13	17.69	18.29	19.62				
HSLB 2010-160-6	16	60	6	8,550	16.61	17.13	17.69	18.29	19.62				
HSLB 2010-180	18	55	4	5,930	18.67	19.26	19.89	20.57	22.07				
HSLB 2010-200	20	55	4	7,180	20.73	21.39	22.09	22.85	24.52				
HSLB 2010-200-6	20	70	6	10,150	20.73	21.39	22.09	22.85	24.52				
HSLB 2010-220-6	22	70	6	10,600	22.80	23.52	24.29	25.12	26.97				
HSLB 2012-025	RO.6	2.5	0.96	1.19	16°	45	4	5,360	2.54	2.60	2.67	2.74	2.91
HSLB 2012-040		4				45	4	5,360	4.08	4.20	4.32	4.45	4.75
HSLB 2012-060		6				45	4	5,810	6.15	6.33	6.52	6.73	7.19
HSLB 2012-060-6		6				50	6	8,270	6.15	6.33	6.52	6.73	7.19
HSLB 2012-080		8				45	4	5,810	8.21	8.46	8.72	9.01	9.64
HSLB 2012-080-6		8				50	6	8,270	8.21	8.46	8.72	9.01	9.64
HSLB 2012-100		10				45	4	5,810	10.27	10.59	10.92	11.28	12.09
HSLB 2012-100-6		10				50	6	8,270	10.27	10.59	10.92	11.28	12.09
HSLB 2012-120		12				45	4	5,810	12.33	12.72	13.12	13.56	14.54
HSLB 2012-120-6		12				50	6	8,270	12.33	12.72	13.12	13.56	14.54
HSLB 2012-140		14				50	4	6,270	14.40	14.85	15.33	15.84	16.98
HSLB 2012-160		16				50	4	6,840	16.46	16.98	17.53	18.12	19.43
HSLB 2012-160-6		16				60	6	9,410	16.46	16.98	17.53	18.12	19.43
HSLB 2012-180		18				55	4	7,410	18.52	19.11	19.73	20.39	21.88
HSLB 2012-200		20				60	4	7,410	20.58	21.23	21.93	22.67	24.33
HSLB 2014-060		RO.7				6	1.12	1.37	16°	45	4	5,020	6.18
HSLB 2014-080	8		45	4	5,020	8.24				8.49	8.75	9.03	9.66
HSLB 2014-120	12		45	4	5,020	12.37				12.75	13.15	13.59	14.56
HSLB 2014-160	16		50	4	5,020	16.49				17.01	17.56	18.14	19.45

UDC Series

CBN Series

Square
Long Neck Square

Radius

Long Neck Radius
Taper Neck Radius

Ball / Long Shank Ball
Long Neck Ball

Taper Neck Ball

Taper

Spiral V Cutter

Drill

EURO Series

Technical Data

Model Number	Radius of Ball Nose R	Effective Length l_1	Length of Cut l	Neck Diameter ϕd_1	Shank Taper Angle β	Overall Length L	Shank Diameter ϕd	Price ¥	Effective Length by Inclined Angles				
									30°	1°	1°30'	2°	3°
HSLB 2015-030	R0.75	3	1.2	1.47	16°	45	4	4,100	3.08	3.16	3.24	3.33	3.53
HSLB 2015-040		4				45	4	4,100	4.11	4.23	4.34	4.47	4.76
HSLB 2015-060		6				45	4	4,100	6.18	6.35	6.55	6.75	7.20
HSLB 2015-060-6		6				50	6	6,610	6.18	6.35	6.55	6.75	7.20
HSLB 2015-080		8				45	4	4,330	8.24	8.48	8.75	9.03	9.65
HSLB 2015-080-6		8				50	6	6,610	8.24	8.48	8.75	9.03	9.65
HSLB 2015-100		10				45	4	4,670	10.30	10.61	10.95	11.30	12.10
HSLB 2015-100-6		10				50	6	6,610	10.30	10.61	10.95	11.30	12.10
HSLB 2015-120		12				45	4	5,020	12.37	12.74	13.15	13.58	14.55
HSLB 2015-120-6		12				50	6	7,520	12.37	12.74	13.15	13.58	14.55
HSLB 2015-140		14				50	4	5,020	14.43	14.87	15.35	15.86	16.99
HSLB 2015-160		16				50	4	5,020	16.49	17.00	17.55	18.14	19.44
HSLB 2015-160-6		16				60	6	7,520	16.49	17.00	17.55	18.14	19.44
HSLB 2015-180		18				55	4	5,020	18.55	19.13	19.75	20.41	21.89
HSLB 2015-200		20				55	4	5,020	20.62	21.26	21.95	22.69	24.34
HSLB 2015-200-6		20				60	6	7,520	20.62	21.26	21.95	22.69	24.34
HSLB 2015-220		22				55	4	5,020	22.68	23.39	24.15	24.97	No Interference
HSLB 2015-250		25				65	4	7,000	25.77	26.59	27.45	28.38	No Interference
HSLB 2015-300		30				70	4	8,210	30.93	31.91	32.96	34.08	No Interference
HSLB 2016-040		R0.8				4	1.28	1.58	16°	45	4	5,700	4.09
HSLB 2016-080	8		45	4	5,810	8.22				8.46	8.72	9.00	9.62
HSLB 2016-120	12		45	4	5,810	12.35				12.72	13.12	13.55	14.51
HSLB 2016-160	16		50	4	5,810	16.47				16.98	17.53	18.11	19.41
HSLB 2016-200	20	55	4	5,810	20.60	21.24	21.93	22.66	No Interference				
HSLB 2018-040	R0.9	4	1.44	1.78	16°	45	4	4,750	4.09	4.20	4.31	4.43	4.70
HSLB 2018-060		6				45	4	4,750	6.15	6.33	6.51	6.71	7.15
HSLB 2018-080		8				45	4	5,020	8.22	8.46	8.71	8.99	9.60
HSLB 2018-100		10				45	4	5,020	10.28	10.59	10.91	11.26	12.04
HSLB 2018-120		12				45	4	5,020	12.34	12.72	13.11	13.54	14.49
HSLB 2018-160		16				50	4	5,020	16.47	16.97	17.52	18.10	19.39
HSLB 2018-180		18				55	4	5,020	18.53	19.10	19.72	20.37	21.83
HSLB 2018-200		20				55	4	5,020	20.59	21.23	21.92	22.65	No Interference
HSLB 2018-220		22				60	4	6,870	22.66	23.36	24.12	24.93	No Interference
HSLB 2018-250		25				65	4	7,000	25.75	26.56	27.42	28.34	No Interference
HSLB 2018-300		30				70	4	7,930	30.91	31.88	32.92	No Interference	No Interference

Next Page ➔

- UDC Series
- CBN Series
- Square
- Long Neck Square
- Radius
- Long Neck Radius
- Taper Neck Radius
- Ball / Long Shank Ball
- Long Neck Ball
- Taper Neck Ball
- Taper
- Spiral V Cutter
- Drill
- EURO Series
- Technical Data

Model Number	Radius of Ball Nose R	Effective Length l_1	Length of Cut l	Neck Diameter ϕd_1	Shank Taper Angle Bia	Overall Length L	Shank Diameter ϕd	Price ¥	Effective Length by Inclined Angles				
									30°	1°	1°30'	2°	3°
HSLB 2020-030	R1	3	1.6	1.98	16°	45	4	3,530	3.06	3.13	3.20	3.28	3.46
HSLB 2020-040		4				45	4	3,530	4.09	4.19	4.30	4.42	4.68
HSLB 2020-040-6		4				50	6	5,590	4.09	4.19	4.30	4.42	4.68
HSLB 2020-060		6				45	4	3,990	6.15	6.32	6.50	6.70	7.13
HSLB 2020-060-6		6				50	6	6,040	6.15	6.32	6.50	6.70	7.13
HSLB 2020-080		8				45	4	4,330	8.21	8.45	8.70	8.97	9.58
HSLB 2020-080-6		8				50	6	6,500	8.21	8.45	8.70	8.97	9.58
HSLB 2020-100		10				45	4	4,330	10.28	10.58	10.90	11.25	12.02
HSLB 2020-100-6		10				50	6	6,500	10.28	10.58	10.90	11.25	12.02
HSLB 2020-120		12				45	4	4,330	12.34	12.71	13.10	13.53	14.47
HSLB 2020-120-6		12				50	6	6,500	12.34	12.71	13.10	13.53	14.47
HSLB 2020-130		13				45	4	4,330	13.37	13.77	14.20	14.67	15.69
HSLB 2020-140		14				50	4	4,330	14.40	14.84	15.31	15.80	16.92
HSLB 2020-160		16				50	4	4,330	16.46	16.97	17.51	18.08	19.36
HSLB 2020-160-6		16				60	6	6,500	16.46	16.97	17.51	18.08	19.36
HSLB 2020-180		18				55	4	4,330	18.53	19.10	19.71	20.36	No Interference
HSLB 2020-200		20				55	4	4,330	20.59	21.23	21.91	22.64	No Interference
HSLB 2020-200-6		20				70	6	6,500	20.59	21.23	21.91	22.64	24.26
HSLB 2020-220		22				60	4	5,930	22.65	23.36	24.11	24.91	No Interference
HSLB 2020-250		25				65	4	6,040	25.75	26.55	27.41	28.33	No Interference
HSLB 2020-250-6	25	80	6	8,550	25.75	26.55	27.41	28.33	30.38				
HSLB 2020-270	27	65	4	6,040	27.81	28.68	29.61	No Interference	No Interference				
HSLB 2020-300	30	70	4	6,840	30.90	31.88	32.91	No Interference	No Interference				
HSLB 2020-300-6	30	80	6	9,690	30.90	31.88	32.91	34.02	36.50				
HSLB 2020-320	32	70	4	6,840	32.97	34.01	35.11	No Interference	No Interference				
HSLB 2020-350	35	80	4	9,350	36.06	37.20	38.42	No Interference	No Interference				
HSLB 2020-350-6	35	80	6	12,650	36.06	37.20	38.42	39.72	No Interference				
HSLB 2020-400	40	80	4	9,350	41.22	42.52	No Interference	No Interference	No Interference				
HSLB 2020-400-6	40	90	6	12,650	41.22	42.52	43.92	45.41	No Interference				
HSLB 2025-060	R1.25	6	2	2.45	16°	45	4	4,670	6.20	6.36	6.53	6.72	7.14
HSLB 2025-080		8				45	4	4,700	8.26	8.49	8.74	9.00	9.59
HSLB 2025-100		10				45	4	4,900	10.32	10.62	10.94	11.28	12.03
HSLB 2025-150		15				50	4	5,810	15.48	15.94	16.44	16.97	No Interference
HSLB 2025-200		20				55	4	6,840	20.64	21.27	21.94	22.66	No Interference
HSLB 2025-250		25				65	4	7,300	25.79	26.59	27.44	No Interference	No Interference
HSLB 2025-300		30				70	4	7,300	30.95	31.92	No Interference	No Interference	No Interference
HSLB 2025-350		35				70	4	8,440	36.11	37.24	No Interference	No Interference	No Interference

Next Page ➔

Unit (mm)

Model Number	Radius of Ball Nose R	Effective Length l_1	Length of Cut l	Neck Diameter ϕd_1	Shank Taper Angle β	Overall Length L	Shank Diameter ϕd	Price ¥	Effective Length by Inclined Angles							
									30°	1°	1°30'	2°	3°			
HSLB 2030-060	R1.5	6	2.4	2.95	16°	60	6	4,330	6.19	6.34	6.51	6.68	7.08			
HSLB 2030-060-3		6			—	60	3	3,990	No Interference	No Interference	No Interference	No Interference	No Interference			
HSLB 2030-060-4		6			60	4	3,990	6.19	6.34	6.51	6.68	7.08				
HSLB 2030-080		8			60	6	4,330	8.25	8.47	8.71	8.96	9.53				
HSLB 2030-100		10			60	6	5,020	10.31	10.60	10.91	11.24	11.98				
HSLB 2030-120		12			60	6	5,240	12.38	12.73	13.11	13.52	14.42				
HSLB 2030-140		14			60	6	5,810	14.44	14.86	15.31	15.79	16.87				
HSLB 2030-150		15			60	6	5,700	15.47	15.93	16.41	16.93	18.09				
HSLB 2030-160		16			60	6	5,810	16.50	16.99	17.51	18.07	19.32				
HSLB 2030-180		18			60	6	5,810	18.56	19.12	19.71	20.35	21.77				
HSLB 2030-200		20			70	6	5,590	20.63	21.25	21.91	22.63	24.21				
HSLB 2030-220		22			70	6	5,590	22.69	23.38	24.12	24.90	26.66				
HSLB 2030-250		25			70	6	5,590	25.78	26.57	27.42	28.32	30.33				
HSLB 2030-270		27			70	6	5,590	27.85	28.70	29.62	30.60	No Interference				
HSLB 2030-300		30			70	6	6,380	30.94	31.90	32.92	34.01	No Interference				
HSLB 2030-320		32			80	6	8,090	33.00	34.03	35.12	36.29	No Interference				
HSLB 2030-350		35			80	6	8,090	36.10	37.22	38.42	39.71	No Interference				
HSLB 2030-400		40			80	6	10,030	41.25	42.55	43.92	No Interference	No Interference				
HSLB 2035-100		R1.75			10	2.8	3.45	16°	60	6	6,380	10.31	10.59	10.88	11.21	11.92
HSLB 2035-150					15				60	6	6,380	15.46	15.91	16.39	16.90	18.04
HSLB 2035-200	20		65	6	6,840				20.62	21.23	21.89	22.59	24.16			
HSLB 2035-250	25		70	6	6,840				25.78	26.56	27.39	28.29	No Interference			
HSLB 2035-300	30		70	6	7,300				30.93	31.88	32.89	33.98	No Interference			
HSLB 2035-400	40		90	6	9,690				41.25	42.53	43.90	No Interference	No Interference			
HSLB 2035-450	45		90	6	10,600				46.40	47.85	49.40	No Interference	No Interference			
HSLB 2040-080	R2	8	3.2	3.95	16°	70	6	4,450	8.23	8.44	8.66	8.89	9.42			
HSLB 2040-080-4		8			—	70	4	4,180	No Interference	No Interference	No Interference	No Interference	No Interference			
HSLB 2040-100		10			70	6	4,450	10.30	10.57	10.86	11.17	11.87				
HSLB 2040-120		12			70	6	5,810	12.36	12.70	13.06	13.45	14.31				
HSLB 2040-140		14			70	6	5,810	14.42	14.83	15.26	15.73	16.76				
HSLB 2040-150		15			70	6	5,810	15.45	15.89	16.36	16.86	17.99				
HSLB 2040-160		16			70	6	5,810	16.49	16.96	17.46	18.00	19.21				
HSLB 2040-180		18			70	6	5,810	18.55	19.09	19.66	20.28	No Interference				
HSLB 2040-200		20			70	6	5,810	20.61	21.22	21.86	22.56	No Interference				
HSLB 2040-220		22			70	6	5,810	22.67	23.35	24.07	24.84	No Interference				
HSLB 2040-250		25			70	6	5,810	25.77	26.54	27.37	28.25	No Interference				
HSLB 2040-270		27			70	6	5,810	27.83	28.67	29.57	30.53	No Interference				
HSLB 2040-300		30			70	6	5,810	30.93	31.87	32.87	No Interference	No Interference				
HSLB 2040-320		32			80	6	6,730	32.99	34.00	35.07	No Interference	No Interference				
HSLB 2040-350		35			80	6	6,730	36.08	37.19	38.37	No Interference	No Interference				
HSLB 2040-400		40			90	6	7,520	41.24	42.51	No Interference	No Interference	No Interference				
HSLB 2040-450		45			90	6	9,690	46.40	47.84	No Interference	No Interference	No Interference				
HSLB 2040-500		50			100	6	10,370	51.55	53.16	No Interference	No Interference	No Interference				
HSLB 2040-600		60			120	6	10,580	61.87	No Interference	No Interference	No Interference	No Interference				

UDC Series

CBN Series

Square

Long Neck Square

Radius

Long Neck Radius

Taper Neck Radius

Ball / Long Shank Ball

Long Neck Ball

Taper Neck Ball

Taper

Spiral V Cutter

Drill

EURO Series

Technical Data

Model Number	Radius of Ball Nose R	Effective Length l_1	Length of Cut l	Neck Diameter ϕd_1	Shank Taper Angle Bia	Overall Length L	Shank Diameter ϕd	Price ¥	Effective Length by Inclined Angles				
									30°	1°	1°30'	2°	3°
HSLB 2050-100	R2.5	10	4	4.95	16°	70	6	6,840	10.28	10.54	10.81	11.10	11.76
HSLB 2050-150		15				70	6	9,690	15.44	15.86	16.31	16.80	No Interference
HSLB 2050-200		20				70	6	9,690	20.60	21.19	21.82	No Interference	No Interference
HSLB 2050-250		25				70	6	9,690	25.75	26.51	No Interference	No Interference	No Interference
HSLB 2050-300		30				80	6	10,370	30.91	31.83	No Interference	No Interference	No Interference
HSLB 2050-350		35				80	6	10,370	36.07	No Interference	No Interference	No Interference	No Interference
HSLB 2050-400		40				90	6	13,110	41.22	No Interference	No Interference	No Interference	No Interference
HSLB 2050-450		45				100	6	13,680	46.38	No Interference	No Interference	No Interference	No Interference
HSLB 2050-500		50				100	6	14,820	51.54	No Interference	No Interference	No Interference	No Interference
HSLB 2060-100		R3				10	4.8	5.95	—	80	6	7,300	No Interference
HSLB 2060-150	15		80	6	7,300	No Interference				No Interference	No Interference	No Interference	No Interference
HSLB 2060-180	18		80	6	7,300	No Interference				No Interference	No Interference	No Interference	No Interference
HSLB 2060-200	20		80	6	7,300	No Interference				No Interference	No Interference	No Interference	No Interference
HSLB 2060-220	22		80	6	7,300	No Interference				No Interference	No Interference	No Interference	No Interference
HSLB 2060-250	25		80	6	7,300	No Interference				No Interference	No Interference	No Interference	No Interference
HSLB 2060-270	27		80	6	7,300	No Interference				No Interference	No Interference	No Interference	No Interference
HSLB 2060-300	30		80	6	7,520	No Interference				No Interference	No Interference	No Interference	No Interference
HSLB 2060-320	32		80	6	7,520	No Interference				No Interference	No Interference	No Interference	No Interference
HSLB 2060-350	35		80	6	7,750	No Interference				No Interference	No Interference	No Interference	No Interference
HSLB 2060-400	40		90	6	8,210	No Interference				No Interference	No Interference	No Interference	No Interference
HSLB 2060-450	45		100	6	8,780	No Interference				No Interference	No Interference	No Interference	No Interference
HSLB 2060-500	50		120	6	8,890	No Interference				No Interference	No Interference	No Interference	No Interference
HSLB 2060-600	60		120	6	9,420	No Interference				No Interference	No Interference	No Interference	No Interference

UDC Series

CBN Series

Square
Long Neck Square

Radius

Radius
Long Neck Radius
Taper Neck Radius

Ball / Long Shank Ball

Ball
Long Neck Ball
Taper Neck Ball

Taper

Spiral V Cutter

Drill

EURO Series

Technical Data

Milling Conditions for HSLB / HSLB-S

WORK MATERIAL			PREHARDENED STEELS HARDENED STEELS NAK / STAVAX (~55HRC)				HARDENED STEELS SKD11 (55~62HRC)				HARDENED STEELS HAP10 (62~66HRC)				HARDENED STEELS HAP72 (66~70HRC)			
Model Number	Radius of Ball Nose (mm)	Effective Length (mm)	Spindle Speed (min ⁻¹)	Feed Rate (mm/min)	a _p Axial Depth (mm)	a _e Radial Depth (mm)	Spindle Speed (min ⁻¹)	Feed Rate (mm/min)	a _p Axial Depth (mm)	a _e Radial Depth (mm)	Spindle Speed (min ⁻¹)	Feed Rate (mm/min)	a _p Axial Depth (mm)	a _e Radial Depth (mm)	Spindle Speed (min ⁻¹)	Feed Rate (mm/min)	a _p Axial Depth (mm)	a _e Radial Depth (mm)
2001	R0.05	0.2	48,000	55	0.002	0.002	48,000	45	0.002	0.002	48,000	45	0.002	0.002	36,000	22	0.002	0.002
		0.3	48,000	55	0.002	0.002	48,000	45	0.002	0.002	48,000	45	0.002	0.002	36,000	22	0.002	0.002
		0.5	48,000	35	0.002	0.002	48,000	35	0.002	0.002	48,000	35	0.002	0.002	36,000	17	0.002	0.002
20015	R0.075	0.3	48,000	90	0.004	0.004	48,000	70	0.004	0.004	48,000	70	0.004	0.004	36,000	35	0.004	0.004
		0.5	48,000	60	0.004	0.004	48,000	50	0.004	0.004	48,000	50	0.004	0.004	36,000	25	0.004	0.004
		1	48,000	60	0.001	0.002	48,000	20	0.001	0.002	48,000	20	0.001	0.002	36,000	10	0.001	0.002
2002	R0.1	0.3	60,000	200	0.003	0.005	60,000	200	0.002	0.003	60,000	130	0.002	0.003	45,000	65	0.002	0.003
		0.5	60,000	200	0.003	0.005	60,000	200	0.002	0.003	60,000	130	0.002	0.003	45,000	65	0.002	0.003
		0.75	60,000	200	0.003	0.005	60,000	200	0.002	0.003	60,000	130	0.002	0.003	45,000	65	0.002	0.003
		1	60,000	200	0.003	0.005	60,000	200	0.002	0.003	60,000	130	0.002	0.003	45,000	65	0.002	0.003
		1.25	60,000	160	0.002	0.004	54,000	140	0.001	0.002	54,000	95	0.001	0.002	40,500	45	0.001	0.002
		1.5	60,000	130	0.002	0.003	48,000	80	0.001	0.002	48,000	65	0.001	0.002	36,000	30	0.001	0.002
		1.75	60,000	110	0.001	0.002	48,000	60	0.001	0.001	48,000	50	0.001	0.001	36,000	25	0.001	0.001
		2	60,000	90	0.001	0.002	48,000	50	0.001	0.001	48,000	40	0.001	0.001	36,000	20	0.001	0.001
		2.25	53,000	70	0.001	0.001	44,200	40	0.001	0.001	44,200	30	0.001	0.001	33,180	15	0.001	0.001
		2.5	46,850	60	0.001	0.001	40,450	30	0.001	0.001	40,450	20	0.001	0.001	30,350	10	0.001	0.001
		3	33,750	30	0.001	0.001	33,600	20	0.001	0.001	33,600	15	0.001	0.001	25,200	7	0.001	0.001
2003	R0.15	0.5	60,000	350	0.006	0.008	45,000	310	0.004	0.007	43,500	180	0.003	0.005	32,500	90	0.003	0.005
		0.6	60,000	350	0.006	0.008	45,000	310	0.004	0.007	43,500	180	0.003	0.005	32,500	90	0.003	0.005
		0.75	60,000	350	0.006	0.008	45,000	310	0.004	0.007	43,500	180	0.003	0.005	32,500	90	0.003	0.005
		1	60,000	350	0.006	0.008	45,000	310	0.004	0.007	43,500	180	0.003	0.005	32,500	90	0.003	0.005
		1.25	60,000	350	0.006	0.008	45,000	310	0.004	0.007	43,500	180	0.003	0.005	32,500	90	0.003	0.005
		1.5	60,000	350	0.006	0.008	45,000	310	0.004	0.007	43,500	180	0.003	0.005	32,500	90	0.003	0.005
		1.75	60,000	280	0.005	0.007	45,000	250	0.003	0.006	43,500	145	0.002	0.004	32,500	70	0.002	0.004
		2	60,000	210	0.004	0.007	45,000	190	0.003	0.005	43,500	110	0.002	0.004	32,500	55	0.002	0.004
		2.25	55,600	190	0.003	0.006	41,500	160	0.002	0.004	40,000	95	0.001	0.003	30,000	45	0.001	0.003
		2.5	51,250	175	0.003	0.005	38,500	135	0.002	0.004	37,750	85	0.001	0.003	28,300	40	0.001	0.003
		3	42,500	140	0.002	0.004	32,000	80	0.002	0.004	32,000	65	0.001	0.002	24,000	30	0.001	0.002
2004	R0.2	4	23,900	45	0.001	0.001	22,550	30	0.001	0.001	22,300	20	0.001	0.001	16,720	10	0.001	0.001
		5	21,000	30	0.001	0.001	20,000	20	0.001	0.001	19,500	10	0.001	0.001	14,600	5	0.001	0.001
		0.5	50,000	500	0.01	0.02	37,500	420	0.007	0.012	35,000	240	0.005	0.008	26,250	120	0.005	0.008
		0.75	50,000	500	0.01	0.02	37,500	420	0.007	0.012	35,000	240	0.005	0.008	26,250	120	0.005	0.008
		1	50,000	500	0.01	0.02	37,500	420	0.007	0.012	35,000	240	0.005	0.008	26,250	120	0.005	0.008
		1.25	50,000	500	0.01	0.02	37,500	420	0.007	0.012	35,000	240	0.005	0.008	26,250	120	0.005	0.008
		1.5	50,000	500	0.01	0.02	37,500	420	0.007	0.012	35,000	240	0.005	0.008	26,250	120	0.005	0.008
		1.75	50,000	500	0.01	0.02	37,500	420	0.007	0.012	35,000	240	0.005	0.008	26,250	120	0.005	0.008
		2	50,000	500	0.01	0.02	37,500	420	0.007	0.012	35,000	240	0.005	0.008	26,250	120	0.005	0.008
		2.25	47,500	430	0.008	0.016	36,000	360	0.006	0.01	33,750	210	0.004	0.007	25,270	100	0.004	0.007
		2.5	45,000	360	0.007	0.012	34,500	300	0.005	0.008	32,500	190	0.004	0.007	24,300	95	0.004	0.007
3	40,000	250	0.005	0.008	31,900	210	0.004	0.008	30,500	160	0.003	0.005	22,800	80	0.003	0.005		
3.5	36,000	210	0.004	0.007	28,700	180	0.003	0.006	27,400	140	0.002	0.004	20,550	70	0.002	0.004		
4	32,000	180	0.003	0.005	25,500	150	0.002	0.004	24,300	120	0.002	0.004	18,200	60	0.002	0.004		
4.5	28,500	150	0.002	0.004	23,500	125	0.002	0.003	22,400	100	0.001	0.003	16,800	50	0.001	0.003		
5	25,000	120	0.002	0.003	21,500	100	0.001	0.002	20,500	80	0.001	0.002	15,350	40	0.001	0.002		
6	18,000	60	0.001	0.002	18,000	60	0.001	0.002	17,000	45	0.001	0.002	12,750	20	0.001	0.002		

UDC Series

CBN Series

Square

Square

Long Neck Square

Radius

Long Neck Radius

Taper Neck Radius

Ball / Long Shank Ball

Long Neck Ball

Taper Neck Ball

Taper

Spiral V Cutter

Drill

EURO Series

Technical Data

Milling Conditions for HSLB / HSLB-S

WORK MATERIAL			PREHARDENED STEELS HARDENED STEELS NAK / STAVAX (~55HRC)				HARDENED STEELS SKD11 (55~62HRC)				HARDENED STEELS HAP10 (62~66HRC)				HARDENED STEELS HAP72 (66~70HRC)			
Model Number	Radius of Ball Nose (mm)	Effective Length (mm)	Spindle Speed (min ⁻¹)	Feed Rate (mm/min)	a _p Axial Depth (mm)	a _e Radial Depth (mm)	Spindle Speed (min ⁻¹)	Feed Rate (mm/min)	a _p Axial Depth (mm)	a _e Radial Depth (mm)	Spindle Speed (min ⁻¹)	Feed Rate (mm/min)	a _p Axial Depth (mm)	a _e Radial Depth (mm)	Spindle Speed (min ⁻¹)	Feed Rate (mm/min)	a _p Axial Depth (mm)	a _e Radial Depth (mm)
2005	R0.25	1	44,000	650	0.015	0.04	33,000	530	0.01	0.02	30,000	300	0.007	0.01	22,500	150	0.007	0.01
		1.25	44,000	650	0.015	0.04	33,000	530	0.01	0.02	30,000	300	0.007	0.01	22,500	150	0.007	0.01
		1.5	44,000	650	0.015	0.04	33,000	530	0.01	0.02	30,000	300	0.007	0.01	22,500	150	0.007	0.01
		1.75	44,000	650	0.015	0.04	33,000	530	0.01	0.02	30,000	300	0.007	0.01	22,500	150	0.007	0.01
		2	44,000	650	0.015	0.04	33,000	530	0.01	0.02	30,000	300	0.007	0.01	22,500	150	0.007	0.01
		2.25	44,000	650	0.015	0.04	33,000	530	0.01	0.02	30,000	300	0.007	0.01	22,500	150	0.007	0.01
		2.5	44,000	650	0.015	0.04	33,000	530	0.01	0.02	30,000	300	0.007	0.01	22,500	150	0.007	0.01
		3	40,000	500	0.01	0.02	31,000	400	0.007	0.01	28,550	230	0.005	0.008	21,400	115	0.005	0.008
		3.5	36,350	340	0.007	0.017	29,000	270	0.005	0.008	27,100	160	0.003	0.006	20,300	80	0.003	0.006
		4	32,700	180	0.005	0.015	27,150	150	0.003	0.008	25,650	100	0.002	0.005	19,900	50	0.002	0.005
		4.5	29,900	150	0.004	0.01	25,700	130	0.002	0.007	24,500	85	0.002	0.004	18,350	43	0.002	0.004
		5	27,000	135	0.003	0.008	24,200	110	0.002	0.005	23,500	75	0.002	0.004	17,600	35	0.002	0.004
		5.5	24,150	110	0.002	0.006	22,750	90	0.001	0.004	22,400	60	0.001	0.003	16,800	30	0.001	0.003
		6	21,350	90	0.002	0.005	21,300	75	0.001	0.003	21,300	50	0.001	0.002	16,000	25	0.001	0.002
		7	18,600	75	0.001	0.004	18,600	55	0.001	0.002	18,600	35	0.001	0.002	13,950	17	0.001	0.002
		8	15,900	60	0.001	0.003	15,900	40	0.001	0.002	15,900	25	0.001	0.002	11,950	12	0.001	0.002
9	15,400	55	0.001	0.002	14,750	30	0.001	0.001	14,750	20	0.001	0.001	11,050	10	0.001	0.001		
10	14,900	50	0.001	0.002	13,600	20	0.001	0.001	13,600	15	0.001	0.001	10,200	7	0.001	0.001		
2006	R0.3	1	40,000	1,400	0.045	0.15	30,000	1,500	0.03	0.13	26,500	1,000	0.015	0.09	20,000	500	0.015	0.09
		1.25	40,000	1,250	0.035	0.14	30,000	1,350	0.025	0.11	26,500	900	0.01	0.08	20,000	450	0.01	0.08
		1.5	40,000	1,100	0.03	0.13	30,000	1,200	0.02	0.1	26,500	800	0.01	0.075	20,000	400	0.01	0.075
		1.75	40,000	1,100	0.03	0.13	30,000	1,200	0.02	0.1	26,500	800	0.01	0.075	20,000	400	0.01	0.075
		2	40,000	1,100	0.03	0.13	30,000	1,200	0.02	0.1	26,500	800	0.01	0.075	20,000	400	0.01	0.075
		2.25	40,000	950	0.025	0.1	30,000	1,000	0.015	0.09	26,500	660	0.008	0.065	20,000	330	0.008	0.07
		2.5	40,000	800	0.02	0.1	30,000	800	0.015	0.09	26,500	520	0.008	0.065	20,000	260	0.008	0.065
		3	40,000	800	0.02	0.1	30,000	800	0.015	0.09	26,500	520	0.008	0.065	20,000	260	0.008	0.065
		3.5	40,000	500	0.015	0.09	30,000	500	0.01	0.075	26,500	340	0.006	0.05	20,000	170	0.006	0.05
		4	40,000	500	0.015	0.09	30,000	500	0.01	0.075	26,500	340	0.006	0.05	20,000	170	0.006	0.05
		4.5	32,000	400	0.01	0.075	25,000	390	0.007	0.05	23,000	260	0.005	0.04	18,000	130	0.005	0.04
		5	32,000	400	0.01	0.075	25,000	390	0.007	0.05	23,000	260	0.005	0.04	18,000	130	0.005	0.04
		5.5	28,000	350	0.008	0.065	23,000	350	0.006	0.05	21,000	230	0.004	0.04	15,750	115	0.004	0.04
		6	24,000	300	0.007	0.06	21,000	320	0.005	0.04	19,500	210	0.004	0.03	15,000	105	0.004	0.03
		6.5	22,000	270	0.006	0.06	19,500	300	0.004	0.04	18,500	190	0.003	0.03	13,900	95	0.003	0.03
		7	20,000	250	0.006	0.05	18,500	280	0.004	0.03	17,500	180	0.003	0.02	13,100	90	0.003	0.02
8	16,000	200	0.005	0.05	16,000	240	0.003	0.02	16,000	160	0.003	0.02	12,000	80	0.003	0.02		
9	15,450	185	0.004	0.035	15,450	200	0.002	0.017	15,450	135	0.002	0.017	11,580	65	0.002	0.017		
10	14,900	175	0.003	0.02	14,900	175	0.002	0.015	14,900	115	0.002	0.015	11,100	55	0.002	0.015		
12	13,800	150	0.002	0.015	13,800	110	0.001	0.01	13,800	70	0.001	0.01	10,350	35	0.001	0.01		
2007	R0.35	2	37,000	1,350	0.045	0.17	28,500	1,400	0.03	0.135	25,000	900	0.015	0.1	18,750	450	0.015	0.1
		4	31,250	920	0.035	0.15	25,750	975	0.025	0.12	23,750	650	0.012	0.09	17,800	325	0.012	0.09
		6	25,500	500	0.025	0.13	23,000	550	0.02	0.11	22,500	400	0.01	0.08	16,850	200	0.01	0.08
		8	19,000	270	0.007	0.06	17,000	320	0.005	0.04	16,500	220	0.004	0.025	12,350	110	0.004	0.025

Milling Conditions for HSLB / HSLB-S

WORK MATERIAL			PREHARDENED STEELS HARDENED STEELS NAK / STAVAX (~55HRC)				HARDENED STEELS SKD11 (55~62HRC)				HARDENED STEELS HAP10 (62~66HRC)				HARDENED STEELS HAP72 (66~70HRC)			
Model Number	Radius of Ball Nose (mm)	Effective Length (mm)	Spindle Speed (min ⁻¹)	Feed Rate (mm/min)	a _p Axial Depth (mm)	a _e Radial Depth (mm)	Spindle Speed (min ⁻¹)	Feed Rate (mm/min)	a _p Axial Depth (mm)	a _e Radial Depth (mm)	Spindle Speed (min ⁻¹)	Feed Rate (mm/min)	a _p Axial Depth (mm)	a _e Radial Depth (mm)	Spindle Speed (min ⁻¹)	Feed Rate (mm/min)	a _p Axial Depth (mm)	a _e Radial Depth (mm)
2008	R0.4	2	35,000	1,600	0.06	0.21	27,000	1,600	0.04	0.17	23,500	1,000	0.02	0.12	17,500	500	0.02	0.12
		3	35,000	1,400	0.05	0.19	27,000	1,400	0.03	0.15	23,500	900	0.015	0.1	17,500	450	0.015	0.1
		4	35,000	1,200	0.04	0.17	27,000	1,200	0.025	0.135	23,500	600	0.012	0.095	17,500	300	0.012	0.095
		5	31,500	900	0.03	0.15	25,000	900	0.02	0.12	22,000	500	0.01	0.085	16,500	250	0.01	0.085
		6	28,000	600	0.02	0.12	23,000	600	0.012	0.095	20,500	400	0.006	0.065	15,500	200	0.006	0.065
		7	23,750	460	0.016	0.105	20,500	480	0.009	0.08	18,750	340	0.005	0.062	14,000	170	0.005	0.062
		8	19,500	330	0.012	0.095	18,000	375	0.007	0.07	17,000	285	0.005	0.06	12,750	140	0.005	0.06
		9	17,500	290	0.011	0.09	16,000	350	0.006	0.06	15,700	250	0.005	0.05	11,800	125	0.005	0.05
		10	15,000	260	0.01	0.085	14,700	340	0.005	0.06	14,650	225	0.004	0.05	11,000	110	0.004	0.05
		12	14,000	220	0.005	0.06	13,700	290	0.003	0.04	13,650	140	0.002	0.03	10,250	70	0.002	0.03
16	13,300	185	0.003	0.02	11,100	150	0.001	0.013	11,100	90	0.001	0.013	8,300	45	0.001	0.013		
2009	R0.45	2	32,500	1,650	0.1	0.28	25,500	1,800	0.55	0.21	22,000	1,300	0.025	0.14	16,500	650	0.025	0.14
		4	32,500	1,650	0.08	0.25	25,500	1,800	0.04	0.18	22,000	1,300	0.02	0.13	16,500	650	0.02	0.13
		6	29,000	800	0.035	0.17	22,000	800	0.02	0.13	20,000	620	0.015	0.11	15,000	310	0.015	0.11
		8	25,500	700	0.015	0.11	18,500	500	0.01	0.09	18,500	420	0.01	0.09	13,850	210	0.01	0.09
		10	20,000	400	0.012	0.1	15,700	400	0.008	0.08	15,700	300	0.008	0.08	11,800	150	0.008	0.08
		12	15,000	280	0.01	0.09	13,300	300	0.006	0.07	13,300	220	0.006	0.07	10,000	110	0.006	0.07
		14	14,000	240	0.007	0.07	12,000	250	0.004	0.035	12,000	160	0.004	0.035	9,000	80	0.004	0.035
		16	13,700	220	0.005	0.05	10,800	200	0.003	0.03	10,800	130	0.003	0.03	8,100	65	0.003	0.03
18	13,000	200	0.004	0.025	9,750	150	0.002	0.015	9,750	100	0.002	0.015	7,300	50	0.002	0.015		
2010	R0.5	2	30,000	1,750	0.2	0.4	24,000	2,000	0.1	0.3	21,000	1,750	0.05	0.2	16,000	875	0.05	0.2
		2.5	30,000	1,750	0.2	0.4	24,000	2,000	0.1	0.3	21,000	1,750	0.05	0.2	16,000	875	0.05	0.2
		3	30,000	1,750	0.1	0.3	24,000	2,000	0.05	0.2	21,000	1,750	0.03	0.17	16,000	875	0.03	0.17
		4	30,000	1,750	0.1	0.3	24,000	2,000	0.05	0.2	21,000	1,750	0.03	0.17	16,000	875	0.03	0.17
		5	30,000	1,750	0.1	0.3	24,000	2,000	0.05	0.2	21,000	1,750	0.03	0.17	16,000	875	0.03	0.17
		6	30,000	1,150	0.06	0.23	21,500	1,250	0.03	0.17	19,700	1,050	0.025	0.15	14,500	525	0.025	0.15
		7	24,250	800	0.04	0.19	20,000	900	0.02	0.14	19,000	750	0.02	0.14	14,250	375	0.02	0.14
		8	24,000	800	0.025	0.155	18,500	580	0.015	0.12	18,400	480	0.015	0.12	13,800	240	0.015	0.12
		9	23,000	700	0.021	0.14	16,650	500	0.012	0.1	16,550	420	0.012	0.1	12,400	210	0.012	0.1
		10	22,000	600	0.018	0.13	14,800	430	0.01	0.09	14,700	360	0.01	0.09	11,100	180	0.01	0.09
		12	14,150	320	0.015	0.12	13,400	380	0.008	0.08	13,300	290	0.008	0.08	9,950	145	0.008	0.08
		14	13,500	280	0.012	0.1	12,000	350	0.007	0.08	12,000	220	0.007	0.08	9,000	110	0.007	0.08
		16	12,750	240	0.008	0.08	10,500	250	0.005	0.045	10,500	160	0.005	0.045	7,850	80	0.005	0.045
		18	12,350	220	0.006	0.065	9,750	200	0.004	0.035	9,750	130	0.004	0.035	7,300	65	0.004	0.035
20	12,000	200	0.005	0.03	9,000	150	0.003	0.02	9,000	100	0.003	0.02	6,750	50	0.003	0.02		
22	12,000	150	0.003	0.02	9,000	110	0.002	0.012	9,000	75	0.002	0.012	6,750	35	0.002	0.012		
2012	R0.6	2.5	30,000	2,000	0.22	0.46	20,500	2,000	0.11	0.34	17,800	1,750	0.05	0.23	13,350	875	0.05	0.23
		4	30,000	2,000	0.12	0.36	20,000	2,000	0.06	0.24	17,500	1,750	0.036	0.2	13,100	875	0.036	0.2
		6	30,000	2,000	0.12	0.36	20,000	2,000	0.06	0.24	17,500	1,750	0.036	0.2	13,100	875	0.036	0.2
		8	20,200	800	0.05	0.23	16,600	900	0.025	0.17	15,850	750	0.025	0.17	11,900	375	0.025	0.17
		10	15,500	480	0.03	0.18	15,500	580	0.015	0.13	15,350	480	0.015	0.13	11,500	240	0.015	0.13
		12	12,400	360	0.02	0.15	12,400	430	0.01	0.095	12,250	360	0.01	0.095	9,200	180	0.01	0.095
		14	11,850	320	0.018	0.14	11,200	380	0.008	0.085	11,100	290	0.008	0.085	8,300	145	0.008	0.085
		16	11,300	280	0.014	0.12	10,000	360	0.007	0.08	10,000	230	0.007	0.08	7,500	115	0.007	0.08
		18	10,900	260	0.011	0.1	9,400	300	0.006	0.07	9,400	190	0.006	0.07	7,050	95	0.006	0.07
		20	10,500	240	0.009	0.09	8,800	250	0.006	0.05	8,800	160	0.006	0.05	6,600	80	0.006	0.05

UDC Series

CBN Series

Square

Long Neck Square

Radius

Long Neck Radius

Taper Neck Radius

Ball / Long Shank Ball

Long Neck Ball

Taper Neck Ball

Taper

Spiral V Cutter

Drill

EURO Series

Technical Data

Milling Conditions for HSLB / HSLB-S

WORK MATERIAL			PREHARDENED STEELS HARDENED STEELS NAK / STAVAX (~55HRC)				HARDENED STEELS SKD11 (55~62HRC)				HARDENED STEELS HAP10 (62~66HRC)				HARDENED STEELS HAP72 (66~70HRC)							
Model Number	Radius of Ball Nose (mm)	Effective Length (mm)	Spindle Speed (min ⁻¹)	Feed Rate (mm/min)	a _p Axial Depth (mm)	a _e Radial Depth (mm)	Spindle Speed (min ⁻¹)	Feed Rate (mm/min)	a _p Axial Depth (mm)	a _e Radial Depth (mm)	Spindle Speed (min ⁻¹)	Feed Rate (mm/min)	a _p Axial Depth (mm)	a _e Radial Depth (mm)	Spindle Speed (min ⁻¹)	Feed Rate (mm/min)	a _p Axial Depth (mm)	a _e Radial Depth (mm)				
UDC Series	2014	R0.7	6	25,200	2,000	0.13	0.42	17,150	2,000	0.065	0.27	15,000	1,750	0.036	0.23	11,250	875	0.036	0.23			
			8	25,200	1,300	0.08	0.32	15,350	1,250	0.04	0.23	14,050	1,050	0.03	0.2	10,550	525	0.03	0.2			
			12	13,500	450	0.035	0.21	12,500	460	0.025	0.18	12,000	300	0.02	0.16	9,000	150	0.02	0.16			
			16	10,000	320	0.016	0.145	9,050	390	0.01	0.12	8,850	230	0.012	0.12	6,650	115	0.012	0.12			
CBN Series	2015	R0.75	3	30,000	2,450	0.25	0.55	17,000	2,000	0.12	0.4	15,000	1,750	0.06	0.29	11,250	875	0.06	0.29			
			4	30,000	2,450	0.25	0.55	17,000	2,000	0.12	0.4	15,000	1,750	0.06	0.29	11,250	875	0.06	0.29			
			6	30,000	2,450	0.15	0.45	17,000	2,000	0.07	0.31	15,000	1,750	0.04	0.24	11,250	875	0.04	0.24			
			8	23,500	1,300	0.1	0.37	15,000	1,250	0.045	0.25	14,000	1,050	0.03	0.21	10,500	525	0.03	0.21			
			10	23,500	1,300	0.1	0.37	15,000	1,250	0.045	0.25	14,000	1,050	0.03	0.21	10,500	525	0.03	0.21			
			12	13,100	480	0.03	0.21	13,000	580	0.02	0.17	13,000	480	0.02	0.17	9,750	240	0.02	0.17			
			14	11,200	400	0.025	0.19	10,900	485	0.015	0.145	10,900	385	0.015	0.145	8,200	190	0.015	0.145			
			16	9,350	320	0.02	0.17	8,850	390	0.012	0.13	8,800	290	0.012	0.13	6,600	145	0.012	0.13			
			18	9,150	300	0.019	0.165	8,400	370	0.011	0.125	8,400	255	0.011	0.125	6,300	125	0.011	0.125			
			20	9,000	280	0.018	0.16	8,000	350	0.01	0.12	8,000	220	0.01	0.12	6,000	110	0.01	0.12			
			22	8,580	245	0.014	0.13	7,150	320	0.008	0.12	7,150	165	0.008	0.12	5,350	80	0.008	0.12			
			25	8,100	210	0.01	0.11	6,250	220	0.006	0.09	6,250	120	0.005	0.08	4,700	60	0.005	0.08			
30	7,600	175	0.006	0.04	5,370	135	0.004	0.03	5,370	75	0.003	0.03	4,000	35	0.003	0.03						
Square	2016	R0.8	4	30,000	2,500	0.25	0.58	17,500	2,100	0.12	0.4	15,300	1,800	0.06	0.3	11,500	900	0.06	0.3			
			8	30,000	2,500	0.16	0.48	17,500	2,100	0.08	0.32	15,300	1,800	0.05	0.275	11,500	900	0.05	0.275			
			12	13,500	500	0.04	0.245	13,500	600	0.024	0.19	13,400	490	0.024	0.19	10,050	245	0.024	0.19			
			16	10,800	375	0.03	0.21	10,800	450	0.016	0.15	10,700	370	0.016	0.15	8,000	185	0.016	0.15			
			20	10,300	330	0.025	0.19	9,750	400	0.013	0.13	9,650	230	0.013	0.13	8,000	115	0.013	0.13			
Long Neck Square	2018	R0.9	4	30,000	2,700	0.28	0.65	15,000	2,000	0.14	0.48	13,000	1,750	0.07	0.34	9,750	875	0.07	0.34			
			6	30,000	2,700	0.18	0.54	15,000	2,000	0.07	0.34	13,000	1,750	0.04	0.26	9,750	875	0.04	0.26			
			8	30,000	2,700	0.18	0.54	15,000	2,000	0.07	0.34	13,000	1,750	0.04	0.26	9,750	875	0.04	0.26			
			10	25,750	2,000	0.14	0.48	14,400	1,650	0.06	0.32	12,900	1,425	0.035	0.24	9,700	713	0.035	0.24			
			12	21,500	1,350	0.1	0.41	13,800	1,350	0.05	0.29	12,800	1,100	0.03	0.23	9,600	550	0.03	0.23			
			16	15,550	860	0.065	0.33	11,700	900	0.03	0.22	11,150	730	0.02	0.18	8,400	385	0.02	0.18			
			18	9,600	375	0.03	0.23	9,600	450	0.015	0.16	9,500	370	0.01	0.13	7,150	185	0.01	0.13			
			20	9,300	350	0.027	0.21	9,050	420	0.014	0.15	9,000	330	0.009	0.12	6,750	165	0.009	0.12			
			22	9,000	320	0.025	0.2	8,500	400	0.012	0.14	8,500	290	0.008	0.15	6,400	145	0.008	0.15			
			25	8,500	280	0.02	0.18	7,750	320	0.01	0.1	7,750	220	0.007	0.09	5,800	110	0.007	0.09			
			30	8,000	240	0.015	0.15	7,000	250	0.009	0.07	7,000	160	0.006	0.06	5,250	80	0.006	0.06			
			Radius	2016	R0.8	4	30,000	2,500	0.25	0.58	17,500	2,100	0.12	0.4	15,300	1,800	0.06	0.3	11,500	900	0.06	0.3
8	30,000	2,500				0.16	0.48	17,500	2,100	0.08	0.32	15,300	1,800	0.05	0.275	11,500	900	0.05	0.275			
12	13,500	500				0.04	0.245	13,500	600	0.024	0.19	13,400	490	0.024	0.19	10,050	245	0.024	0.19			
16	10,800	375				0.03	0.21	10,800	450	0.016	0.15	10,700	370	0.016	0.15	8,000	185	0.016	0.15			
20	10,300	330				0.025	0.19	9,750	400	0.013	0.13	9,650	230	0.013	0.13	8,000	115	0.013	0.13			
Long Neck Radius	2018	R0.9				4	30,000	2,700	0.28	0.65	15,000	2,000	0.14	0.48	13,000	1,750	0.07	0.34	9,750	875	0.07	0.34
						6	30,000	2,700	0.18	0.54	15,000	2,000	0.07	0.34	13,000	1,750	0.04	0.26	9,750	875	0.04	0.26
						8	30,000	2,700	0.18	0.54	15,000	2,000	0.07	0.34	13,000	1,750	0.04	0.26	9,750	875	0.04	0.26
						10	25,750	2,000	0.14	0.48	14,400	1,650	0.06	0.32	12,900	1,425	0.035	0.24	9,700	713	0.035	0.24
						12	21,500	1,350	0.1	0.41	13,800	1,350	0.05	0.29	12,800	1,100	0.03	0.23	9,600	550	0.03	0.23
						16	15,550	860	0.065	0.33	11,700	900	0.03	0.22	11,150	730	0.02	0.18	8,400	385	0.02	0.18
						18	9,600	375	0.03	0.23	9,600	450	0.015	0.16	9,500	370	0.01	0.13	7,150	185	0.01	0.13
			20	9,300	350	0.027	0.21	9,050	420	0.014	0.15	9,000	330	0.009	0.12	6,750	165	0.009	0.12			
			22	9,000	320	0.025	0.2	8,500	400	0.012	0.14	8,500	290	0.008	0.15	6,400	145	0.008	0.15			
			25	8,500	280	0.02	0.18	7,750	320	0.01	0.1	7,750	220	0.007	0.09	5,800	110	0.007	0.09			
			30	8,000	240	0.015	0.15	7,000	250	0.009	0.07	7,000	160	0.006	0.06	5,250	80	0.006	0.06			
			Taper Neck Square	2016	R0.8	4	30,000	2,500	0.25	0.58	17,500	2,100	0.12	0.4	15,300	1,800	0.06	0.3	11,500	900	0.06	0.3
8	30,000	2,500				0.16	0.48	17,500	2,100	0.08	0.32	15,300	1,800	0.05	0.275	11,500	900	0.05	0.275			
12	13,500	500				0.04	0.245	13,500	600	0.024	0.19	13,400	490	0.024	0.19	10,050	245	0.024	0.19			
16	10,800	375				0.03	0.21	10,800	450	0.016	0.15	10,700	370	0.016	0.15	8,000	185	0.016	0.15			
20	10,300	330				0.025	0.19	9,750	400	0.013	0.13	9,650	230	0.013	0.13	8,000	115	0.013	0.13			
Ball / Long Shank Ball	2018	R0.9				4	30,000	2,700	0.28	0.65	15,000	2,000	0.14	0.48	13,000	1,750	0.07	0.34	9,750	875	0.07	0.34
						6	30,000	2,700	0.18	0.54	15,000	2,000	0.07	0.34	13,000	1,750	0.04	0.26	9,750	875	0.04	0.26
						8	30,000	2,700	0.18	0.54	15,000	2,000	0.07	0.34	13,000	1,750	0.04	0.26	9,750	875	0.04	0.26
						10	25,750	2,000	0.14	0.48	14,400	1,650	0.06	0.32	12,900	1,425	0.035	0.24	9,700	713	0.035	0.24
						12	21,500	1,350	0.1	0.41	13,800	1,350	0.05	0.29	12,800	1,100	0.03	0.23	9,600	550	0.03	0.23
						16	15,550	860	0.065	0.33	11,700	900	0.03	0.22	11,150	730	0.02	0.18	8,400	385	0.02	0.18
						18	9,600	375	0.03	0.23	9,600	450	0.015	0.16	9,500	370	0.01	0.13	7,150	185	0.01	0.13
			20	9,300	350	0.027	0.21	9,050	420	0.014	0.15	9,000	330	0.009	0.12	6,750	165	0.009	0.12			
			22	9,000	320	0.025	0.2	8,500	400	0.012	0.14	8,500	290	0.008	0.15	6,400	145	0.008	0.15			
			25	8,500	280	0.02	0.18	7,750	320	0.01	0.1	7,750	220	0.007	0.09	5,800	110	0.007	0.09			
			30	8,000	240	0.015	0.15	7,000	250	0.009	0.07	7,000	160	0.006	0.06	5,250	80	0.006	0.06			
			Long Neck Ball	2018	R0.9	4	30,000	2,700	0.28	0.65	15,000	2,000	0.14	0.48	13,000	1,750	0.07	0.34	9,750	875	0.07	0.34
6	30,000	2,700				0.18	0.54	15,000	2,000	0.07	0.34	13,000	1,750	0.04	0.26	9,750	875	0.04	0.26			
8	30,000	2,700				0.18	0.54	15,000	2,000	0.07	0.34	13,000	1,750	0.04	0.26	9,750	875	0.04	0.26			
10	25,750	2,000				0.14	0.48	14,400	1,650	0.06	0.32	12,900	1,425	0.035	0.24	9,700	713	0.035	0.24			
12	21,500	1,350				0.1	0.41	1														

Milling Conditions for HSLB / HSLB-S

WORK MATERIAL			PREHARDENED STEELS HARDENED STEELS NAK / STAVAX (~55HRC)				HARDENED STEELS SKD11 (55~62HRC)				HARDENED STEELS HAP10 (62~66HRC)				HARDENED STEELS HAP72 (66~70HRC)			
Model Number	Radius of Ball Nose (mm)	Effective Length (mm)	Spindle Speed (min ⁻¹)	Feed Rate (mm/min)	a _p Axial Depth (mm)	a _e Radial Depth (mm)	Spindle Speed (min ⁻¹)	Feed Rate (mm/min)	a _p Axial Depth (mm)	a _e Radial Depth (mm)	Spindle Speed (min ⁻¹)	Feed Rate (mm/min)	a _p Axial Depth (mm)	a _e Radial Depth (mm)	Spindle Speed (min ⁻¹)	Feed Rate (mm/min)	a _p Axial Depth (mm)	a _e Radial Depth (mm)
2020	R1	3	28,000	2,900	0.3	0.7	14,000	2,100	0.15	0.5	12,250	1,800	0.08	0.35	9,200	900	0.08	0.35
		4	28,000	2,900	0.3	0.7	14,000	2,100	0.15	0.5	12,250	1,800	0.08	0.35	9,200	900	0.08	0.35
		6	28,000	2,900	0.2	0.6	14,000	2,100	0.1	0.4	12,250	1,800	0.06	0.3	9,200	900	0.06	0.3
		8	28,000	2,900	0.2	0.6	14,000	2,100	0.1	0.4	12,250	1,800	0.06	0.3	9,200	900	0.06	0.3
		10	28,000	2,900	0.2	0.6	14,000	2,100	0.1	0.4	12,250	1,800	0.06	0.3	9,200	900	0.06	0.3
		12	19,500	1,350	0.12	0.45	12,400	1,350	0.06	0.34	11,500	1,100	0.045	0.27	8,650	550	0.045	0.27
		13	19,500	1,350	0.12	0.45	12,400	1,350	0.06	0.34	11,500	1,100	0.045	0.27	8,650	550	0.045	0.27
		14	19,500	1,350	0.12	0.45	12,400	1,350	0.06	0.34	11,500	1,100	0.045	0.27	8,650	550	0.045	0.27
		16	10,800	500	0.05	0.3	10,800	600	0.03	0.24	10,700	490	0.03	0.24	8,000	245	0.03	0.24
		18	9,700	435	0.04	0.28	9,700	520	0.025	0.22	9,650	430	0.025	0.22	7,250	215	0.025	0.22
		20	8,650	375	0.035	0.25	8,650	450	0.02	0.19	8,560	370	0.02	0.19	6,400	185	0.02	0.19
		22	8,450	350	0.032	0.245	8,200	440	0.018	0.18	8,200	330	0.018	0.18	6,150	165	0.018	0.18
		25	8,250	320	0.03	0.24	7,800	440	0.016	0.16	7,800	290	0.016	0.16	5,850	145	0.016	0.16
		27	8,050	300	0.027	0.22	7,400	390	0.015	0.16	7,400	250	0.015	0.16	5,550	120	0.015	0.16
		30	7,850	280	0.024	0.2	7,000	350	0.014	0.16	7,000	220	0.014	0.16	5,250	110	0.014	0.16
		32	7,650	260	0.02	0.18	6,550	300	0.012	0.12	6,550	190	0.012	0.12	4,900	90	0.012	0.12
35	7,450	240	0.016	0.16	6,150	250	0.01	0.09	6,150	160	0.01	0.09	4,600	80	0.01	0.09		
40	7,000	200	0.01	0.06	5,250	150	0.006	0.04	5,250	100	0.006	0.04	3,950	50	0.006	0.04		
2025	R1.25	6	25,000	3,000	0.35	0.85	12,400	2,200	0.17	0.6	11,000	1,850	0.1	0.45	8,250	920	0.1	0.45
		8	25,000	3,000	0.24	0.76	12,400	2,200	0.13	0.51	11,000	1,850	0.08	0.38	8,250	920	0.08	0.38
		10	25,000	3,000	0.24	0.76	12,400	2,200	0.13	0.51	11,000	1,850	0.08	0.38	8,250	920	0.08	0.38
		15	17,300	1,400	0.145	0.57	11,000	1,400	0.08	0.44	10,300	1,140	0.06	0.35	7,700	570	0.06	0.35
		20	9,600	520	0.06	0.38	9,600	630	0.04	0.31	9,600	510	0.04	0.31	7,200	255	0.04	0.31
		25	6,900	375	0.042	0.32	6,900	450	0.024	0.235	6,840	370	0.024	0.235	5,150	185	0.024	0.235
		30	6,500	320	0.025	0.24	6,200	400	0.02	0.22	6,200	280	0.02	0.22	4,650	140	0.02	0.22
35	6,200	280	0.017	0.2	5,500	350	0.014	0.18	5,500	220	0.014	0.18	4,150	110	0.014	0.18		
2030	R1.5	6	21,000	3,000	0.4	1	10,500	2,200	0.2	0.7	9,200	1,900	0.12	0.55	6,900	950	0.12	0.55
		8	21,000	3,000	0.4	1	10,500	2,200	0.2	0.7	9,200	1,900	0.12	0.55	6,900	950	0.12	0.55
		10	21,000	3,000	0.3	0.9	10,500	2,200	0.15	0.65	9,200	1,900	0.1	0.5	6,900	950	0.1	0.5
		12	21,000	3,000	0.3	0.9	10,500	2,200	0.15	0.65	9,200	1,900	0.1	0.5	6,900	950	0.1	0.5
		14	21,000	3,000	0.3	0.9	10,500	2,200	0.15	0.65	9,200	1,900	0.1	0.5	6,900	950	0.1	0.5
		15	21,000	3,000	0.3	0.9	10,500	2,200	0.15	0.65	9,200	1,900	0.1	0.5	6,900	950	0.1	0.5
		16	21,000	3,000	0.3	0.9	10,500	2,200	0.15	0.65	9,200	1,900	0.1	0.5	6,900	950	0.1	0.5
		18	17,750	2,180	0.24	0.8	9,800	1,800	0.13	0.57	8,900	1,500	0.08	0.47	6,650	760	0.08	0.47
		20	14,500	1,360	0.18	0.7	9,250	1,400	0.1	0.5	8,600	1,150	0.075	0.45	6,450	575	0.075	0.45
		22	11,250	940	0.12	0.57	8,625	1,000	0.07	0.44	8,300	830	0.06	0.41	6,200	410	0.06	0.41
		25	8,000	520	0.07	0.45	8,000	630	0.05	0.38	8,000	510	0.05	0.38	6,000	255	0.05	0.38
		27	6,850	440	0.06	0.41	6,850	540	0.04	0.33	6,850	440	0.04	0.33	5,100	220	0.04	0.33
		30	5,750	375	0.05	0.38	5,750	450	0.03	0.29	5,700	370	0.03	0.29	4,275	185	0.03	0.29
		32	5,650	350	0.045	0.37	5,550	440	0.025	0.28	5,500	340	0.025	0.28	4,100	170	0.025	0.28
35	5,550	335	0.045	0.36	5,350	440	0.025	0.27	5,350	310	0.025	0.27	4,000	155	0.025	0.27		
40	5,350	300	0.04	0.34	4,900	390	0.02	0.24	4,850	250	0.02	0.24	3,650	125	0.02	0.24		

- UDC Series
- CBN Series
- Square
- Square
- Long Neck Square
- Radius
- Radius
- Long Neck Radius
- Taper Neck Radius
- Ball / Long Shank Ball
- Ball
- Long Neck Ball
- Taper Neck Ball
- Taper
- Taper
- Spiral V Cutter
- Drill
- EURO Series
- Technical Data

Milling Conditions for HSLB / HSLB-S

WORK MATERIAL			PREHARDENED STEELS HARDENED STEELS NAK / STAVAX (~55HRC)				HARDENED STEELS SKD11 (55~62HRC)				HARDENED STEELS HAP10 (62~66HRC)				HARDENED STEELS HAP72 (66~70HRC)				
Model Number	Radius of Ball Nose (mm)	Effective Length (mm)	Spindle Speed (min ⁻¹)	Feed Rate (mm/min)	a _p Axial Depth (mm)	a _e Radial Depth (mm)	Spindle Speed (min ⁻¹)	Feed Rate (mm/min)	a _p Axial Depth (mm)	a _e Radial Depth (mm)	Spindle Speed (min ⁻¹)	Feed Rate (mm/min)	a _p Axial Depth (mm)	a _e Radial Depth (mm)	Spindle Speed (min ⁻¹)	Feed Rate (mm/min)	a _p Axial Depth (mm)	a _e Radial Depth (mm)	
UDC Series	2035	R1.75	10	19,000	3,000	0.35	1.05	10,000	2,200	0.17	0.75	8,400	1,900	0.11	0.61	6,300	950	0.11	0.61
			15	19,000	3,000	0.35	1.05	10,000	2,200	0.17	0.75	8,400	1,900	0.11	0.61	6,300	950	0.11	0.61
			20	19,000	3,000	0.35	1.05	10,000	2,200	0.17	0.75	8,400	1,900	0.11	0.61	6,300	950	0.11	0.61
			25	13,000	1,750	0.21	0.83	8,450	1,400	0.11	0.61	7,650	1,200	0.08	0.52	5,750	600	0.08	0.52
			30	6,900	520	0.08	0.52	6,900	630	0.06	0.45	6,900	510	0.06	0.45	5,200	255	0.06	0.45
			40	5,750	410	0.06	0.45	5,550	510	0.04	0.37	5,500	380	0.04	0.37	4,150	190	0.04	0.37
			45	4,600	300	0.045	0.39	4,200	390	0.025	0.29	4,100	250	0.025	0.29	3,100	125	0.025	0.29
Square	2040	R2	8	18,000	3,200	0.5	1.3	9,000	2,300	0.25	0.95	7,900	2,000	0.15	0.75	5,900	1,000	0.15	0.75
			10	18,000	3,200	0.5	1.3	9,000	2,300	0.25	0.95	7,900	2,000	0.15	0.75	5,900	1,000	0.15	0.75
			12	18,000	3,200	0.4	1.2	9,000	2,300	0.2	0.85	7,900	2,000	0.13	0.7	5,900	1,000	0.13	0.7
			14	18,000	3,200	0.4	1.2	9,000	2,300	0.2	0.85	7,900	2,000	0.13	0.7	5,900	1,000	0.13	0.7
			15	18,000	3,200	0.4	1.2	9,000	2,300	0.2	0.85	7,900	2,000	0.13	0.7	5,900	1,000	0.13	0.7
			16	18,000	3,200	0.4	1.2	9,000	2,300	0.2	0.85	7,900	2,000	0.13	0.7	5,900	1,000	0.13	0.7
			18	18,000	3,200	0.4	1.2	9,000	2,300	0.2	0.85	7,900	2,000	0.13	0.7	5,900	1,000	0.13	0.7
			20	18,000	3,200	0.4	1.2	9,000	2,300	0.2	0.85	7,900	2,000	0.13	0.7	5,900	1,000	0.13	0.7
			22	15,000	2,350	0.32	1.05	8,500	1,850	0.16	0.75	7,650	1,600	0.11	0.6	5,750	810	0.11	0.6
			25	12,500	1,500	0.25	0.95	8,000	1,450	0.13	0.7	7,450	1,250	0.09	0.55	5,600	625	0.09	0.55
			27	9,750	1,000	0.17	0.76	7,500	1,050	0.09	0.55	7,200	890	0.07	0.5	5,400	440	0.07	0.5
			30	7,000	550	0.1	0.6	7,000	660	0.06	0.45	7,000	540	0.06	0.45	5,250	270	0.06	0.45
			32	6,500	535	0.09	0.59	6,500	640	0.055	0.44	6,500	520	0.055	0.44	4,850	260	0.055	0.44
			35	6,000	520	0.09	0.59	6,000	630	0.055	0.43	6,000	510	0.055	0.43	4,500	255	0.055	0.43
40	4,300	375	0.065	0.5	4,300	450	0.04	0.39	4,300	370	0.04	0.39	3,200	185	0.04	0.39			
45	4,150	330	0.058	0.47	4,000	440	0.033	0.36	4,000	300	0.033	0.36	3,000	150	0.033	0.36			
50	4,000	300	0.053	0.44	3,750	400	0.03	0.33	3,750	260	0.03	0.33	2,800	130	0.03	0.33			
60	3,900	280	0.048	0.4	3,500	350	0.028	0.3	3,500	220	0.028	0.3	2,600	110	0.028	0.3			
Ball / Long Shank Ball	2050	R2.5	10	14,400	3,200	0.5	1.5	7,200	2,300	0.25	1.05	6,350	2,000	0.16	0.88	4,750	1,000	0.16	0.88
			15	14,400	3,200	0.5	1.5	7,200	2,300	0.25	1.05	6,350	2,000	0.16	0.88	4,750	1,000	0.16	0.88
			20	14,400	3,200	0.5	1.5	7,200	2,300	0.25	1.05	6,350	2,000	0.16	0.88	4,750	1,000	0.16	0.88
			25	12,200	2,350	0.405	1.35	6,800	1,850	0.205	0.95	6,250	1,600	0.135	0.805	4,650	800	0.135	0.805
			30	10,000	1,500	0.31	1.2	6,400	1,450	0.16	0.88	6,200	1,250	0.11	0.73	4,650	625	0.11	0.73
			35	8,000	1,050	0.21	1	6,200	1,070	0.12	0.76	6,100	900	0.095	0.68	4,600	450	0.095	0.68
			40	6,000	570	0.125	0.78	6,000	690	0.08	0.625	6,000	570	0.08	0.625	4,500	285	0.08	0.625
			45	5,150	500	0.11	0.72	5,150	600	0.07	0.4	5,100	500	0.07	0.4	3,800	250	0.07	0.4
			50	4,300	430	0.09	0.65	4,300	510	0.06	0.18	4,200	435	0.06	0.18	3,150	215	0.06	0.18

UDC Series

CBN Series

Square
Long Neck Square

Radius

Radius
Long Neck Radius
Taper Neck Radius

Ball / Long Shank Ball
Long Neck Ball

Taper

Spiral V Cutter

Drill

EURO Series

Technical Data

Milling Conditions for HSLB / HSLB-S

WORK MATERIAL			PREHARDENED STEELS HARDENED STEELS NAK / STAVAX (~55HRC)				HARDENED STEELS SKD11 (55~62HRC)				HARDENED STEELS HAP10 (62~66HRC)				HARDENED STEELS HAP72 (66~70HRC)			
Model Number	Radius of Ball Nose (mm)	Effective Length (mm)	Spindle Speed (min ⁻¹)	Feed Rate (mm/min)	a_p Axial Depth (mm)	a_e Radial Depth (mm)	Spindle Speed (min ⁻¹)	Feed Rate (mm/min)	a_p Axial Depth (mm)	a_e Radial Depth (mm)	Spindle Speed (min ⁻¹)	Feed Rate (mm/min)	a_p Axial Depth (mm)	a_e Radial Depth (mm)	Spindle Speed (min ⁻¹)	Feed Rate (mm/min)	a_p Axial Depth (mm)	a_e Radial Depth (mm)
2060	R3	10	13,000	3,500	0.6	1.8	6,500	2,500	0.3	1.3	5,700	2,200	0.2	1	4,300	1,100	0.2	1
		15	13,000	3,500	0.6	1.8	6,500	2,500	0.3	1.3	5,700	2,200	0.2	1	4,300	1,100	0.2	1
		18	13,000	3,500	0.6	1.8	6,500	2,500	0.3	1.3	5,700	2,200	0.2	1	4,300	1,100	0.2	1
		20	13,000	3,500	0.6	1.8	6,500	2,500	0.3	1.3	5,700	2,200	0.2	1	4,300	1,100	0.2	1
		22	13,000	3,500	0.6	1.8	6,500	2,500	0.3	1.3	5,700	2,200	0.2	1	4,300	1,100	0.2	1
		25	13,000	3,500	0.6	1.8	6,500	2,500	0.3	1.3	5,700	2,200	0.2	1	4,300	1,100	0.2	1
		27	13,000	3,500	0.6	1.8	6,500	2,500	0.3	1.3	5,700	2,200	0.2	1	4,300	1,100	0.2	1
		30	13,000	3,500	0.6	1.8	6,500	2,500	0.3	1.3	5,700	2,200	0.2	1	4,300	1,100	0.2	1
		32	12,000	3,100	0.54	1.7	6,300	2,250	0.27	1.15	5,600	2,000	0.18	0.9	4,200	1,000	0.18	0.9
		35	11,000	2,750	0.48	1.6	6,100	2,050	0.25	1.05	5,500	1,800	0.175	0.8	4,150	900	0.175	0.8
		40	9,000	2,050	0.375	1.35	5,750	1,600	0.2	0.8	5,350	1,400	0.15	0.65	4,000	700	0.15	0.65
		45	7,000	1,300	0.26	1.1	5,350	1,150	0.15	0.55	5,150	1,000	0.125	0.45	3,850	500	0.125	0.45
50	5,000	600	0.15	0.9	5,000	720	0.1	0.3	5,000	600	0.1	0.3	3,750	300	0.1	0.3		
60	3,600	430	0.105	0.75	3,600	510	0.08	0.22	3,550	435	0.08	0.22	2,650	215	0.08	0.22		

a_p : Axial Depth (mm)
 a_e : Radial Depth (mm)

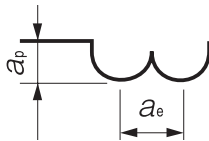

- Note:
- Decrease the feed rate more than 50% from the milling parameters when slot milling.
 - Decrease both spindle speed and feed rate proportionally when the milling parameters exceed the machines maximum speed, or when the tool is chattering and heats up to a red color.
 - Every coolant offers stable milling.

- UDC Series
- CBN Series
- Square
- Long Neck Square
- Radius
- Long Neck Radius
- Taper Neck Radius
- Ball / Long Shank Ball
- Long Neck Ball
- Taper Neck Ball
- Taper
- Spiral V Cutter
- Drill
- EURO Series
- Technical Data

Copper Electrode Milling Comparison : HSLB generates **less side force to reduce work piece deflection**

Variable rake cutting edge reduces tool deflection!
 Better wear resistance than conventional +Rake.
 After extended milling time, **new HSLB makes less deflection than conventional HLB!**

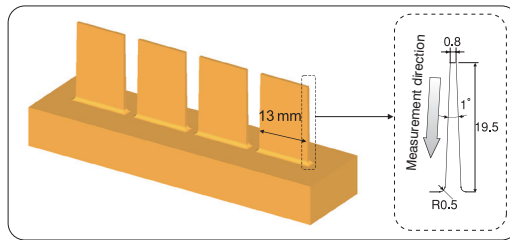
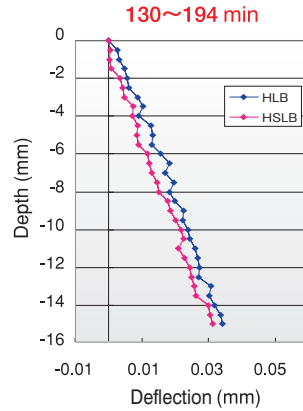
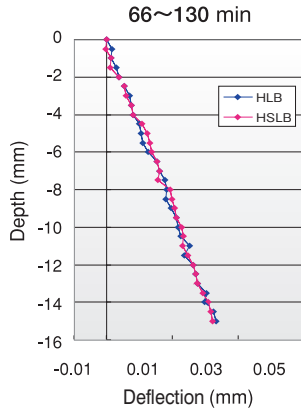

Tool: HSLB R0.5 x Effective Length 20 mm

Work Material	Copper (C1100)
Spindle Speed n	9,350 min^{-1}
Feed Rate V_f	540 mm/min
Velocity V_c	29.4 m/min
Feed per tooth f_z	0.029 mm/tooth
Axial Depth a_p	0.017 mm
Radial Depth a_e	0.01 mm
Overhang Length	30 mm
Cycle Time	66 min/pocket
Coolant	Water Soluble
Milling Method	Contouring

* Refer to page 580 for tool geometry.

Wear Comparison: Better wear resistance compared to HB / HLB, for a wide range of materials.

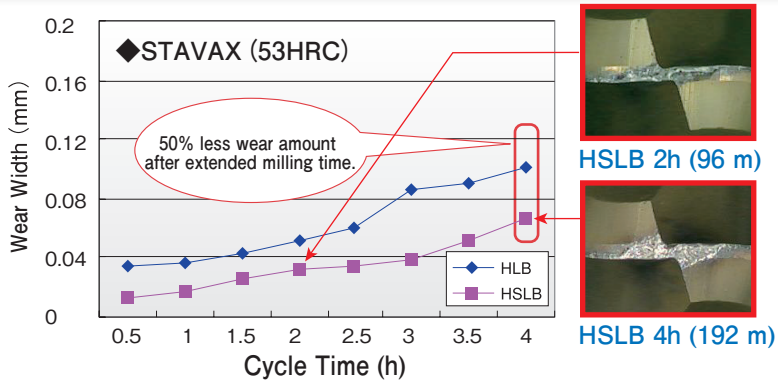

Tool: HSLB R0.5 x Effective Length 6 mm

Work Material	STAVAX (53HRC)
Spindle Speed n	24,000 min^{-1}
Feed Rate V_f	800 mm/min
Velocity V_c	75.4 m/min
Feed per tooth f_z	0.017 mm/tooth
Axial Depth a_p	0.024 mm
Radial Depth a_e	0.057 mm
Overhang Length	20 mm
Coolant	Air Blow
Milling Method	Flat Pocket Milling

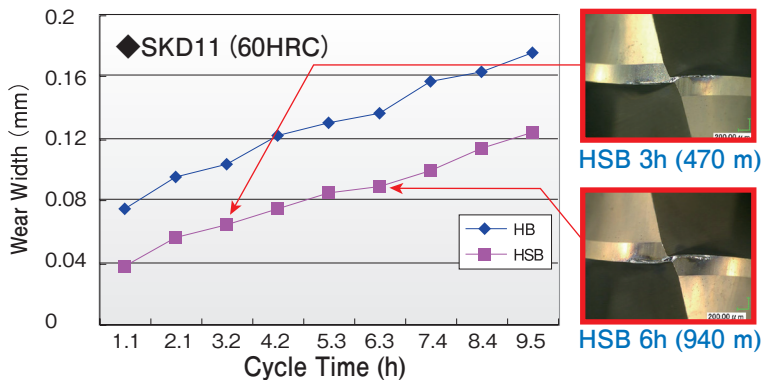

Tool: HSB R3 x Length of Cut 9 mm

Work Material	SKD11 (60HRC)
Spindle Speed n	10,000 min^{-1}
Feed Rate V_f	3,000 mm/min
Velocity V_c	188 m/min
Feed per tooth f_z	0.15 mm/tooth
Axial Depth a_p	0.1 mm
Radial Depth a_e	0.15 mm
Overhang Length	20 mm
Coolant	Air Blow
Milling Method	Flat Milling (both ways)

UDC Series

CBN Series

Square

Long Neck Square

Radius

Long Neck Radius

Taper Neck Radius

Ball / Long Shank Ball

Long Neck Ball

Taper Neck Ball

Taper

Spiral V Cutter

Drill

EURO Series

Technical Data



Size R0.1~R3

Short Shank Series

HSLB-S



R0.1~R2

R3

~Except for R0.4
ℓ₁ / D ≤ 10

Material Applications (☆ Highly Recommended ○ Recommended ○ Suggested)

Work Material															
Carbon Steels S45C S55C	Alloy Steels SK / SCM SUS	Prehardened Steels NAK HPM	Hardened Steels			Cast Iron	Aluminum Alloys	Graphite	Copper	Plastics	Glass Filled Plastics	Titanium Alloys	Heat Resistant Alloys	Cemented Carbide	Hard Brittle (Non-Metallic) Materials
			~55HRC	~60HRC	~70HRC										
○	○	○	○	○	○	○			○			○	○		

Features

Short Shank Long Neck Ball End Mills for high accuracy shrink-fit holder.
 Offers high efficiency, long tool life and excellent surface finish on hard materials over 40HRC.
 HARDMAX coat offers heat resistance, durability and lubricity at a high level.
 Every coolant offers stable milling.
 Ball tip point is designed with a negative rake angle that minimizes wear and improves the target dimensions.
 The low negative rake angle at the peripheral side of the ball offers an excellent surface finish and prevents deflection.

Better Tolerance Design! Diameter Tolerance, Ball Radius Accuracy, and Shank Diameter Tolerance

HSB / HSLB Tolerance

Radius of Ball Nose	Diameter Tolerance	Ball Radius Accuracy	Shank Diameter Tolerance
R0.1 ~ R3	0/-0.015	±0.005	0/-0.005 (h5)

HSB-S / HSLB-S Tolerance

Radius of Ball Nose	Diameter Tolerance	Ball Radius Accuracy	Shank Diameter Tolerance
R0.1 ~ R1	0/-0.008	±0.003	0/-0.004 (h4)
R1.5 ~ R2	0/-0.01		
R3		±0.005	

Shank diameter tolerance h4!

Short overhang length with short shank length!

Conventional series **New Short shank series**

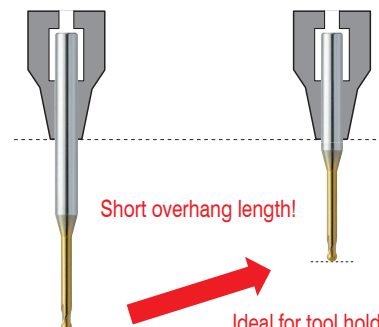

Short overhang length minimizes tool run-out

High precision milling

Minimizes vibration and chattering

Longer tool life

Ideal for tool holders where the maximum insertion is short.

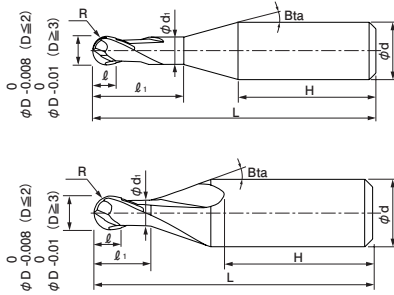

The shank taper angle and the shank length (H) shown are not an exact value and to avoid contact with the work piece, we recommend the user controls the precise value of this angle. Shank taper angle should not make contact with the work piece.

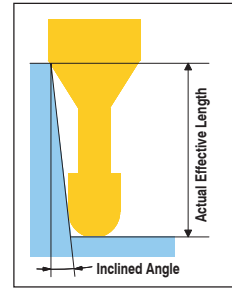

Total 61 models

Unit (mm)

Model Number	Radius of Ball Nose R	Effective Length ℓ_1	Length of Cut ℓ	Neck Diameter ϕd_1	Shank Taper Angle Bta	Overall Length L	Shank Diameter ϕd	Shank Length H	Price ¥	Effective Length by Inclined Angles				
										30'	1°	1°30'	2°	3°
HSLB 2002-005S	RO.1	0.5	0.16	0.19	16°	35	4	26.0	8,090	0.63	0.66	0.68	0.71	0.76
HSLB 2002-010S		1				35	4	25.5	8,090	1.15	1.20	1.24	1.28	1.37
HSLB 2003-005S	RO.15	0.5	0.24	0.29	16°	35	4	26.0	7,980	0.63	0.65	0.68	0.70	0.75
HSLB 2003-0075S		0.75				35	4	26.0	7,980	0.89	0.92	0.96	0.99	1.05
HSLB 2003-010S		1				35	4	25.5	7,980	1.15	1.19	1.23	1.27	1.36
HSLB 2003-015S		1.5				35	4	25.0	8,550	1.66	1.72	1.77	1.83	1.96
HSLB 2004-005S	RO.2	0.5	0.32	0.39	16°	35	4	26.5	5,470	0.63	0.65	0.67	0.70	0.74
HSLB 2004-010S		1				35	4	26.0	5,470	1.15	1.19	1.23	1.26	1.35
HSLB 2004-015S		1.5				35	4	25.5	5,590	1.66	1.71	1.77	1.82	1.95
HSLB 2004-020S		2				35	4	25.0	5,700	2.18	2.25	2.32	2.39	2.56
HSLB 2004-025S		2.5				35	4	24.5	5,930	2.70	2.78	2.87	2.96	3.17
HSLB 2004-030S		3				35	4	24.0	6,270	3.21	3.31	3.42	3.53	3.79
HSLB 2005-010S	RO.25	1	0.4	0.49	16°	35	4	26.0	5,470	1.15	1.19	1.22	1.26	1.34
HSLB 2005-015S		1.5				35	4	25.5	5,470	1.65	1.71	1.76	1.82	1.94
HSLB 2005-020S		2				35	4	25.0	5,470	2.18	2.24	2.31	2.39	2.55
HSLB 2005-025S		2.5				35	4	24.5	5,470	2.69	2.78	2.86	2.96	3.16
HSLB 2005-030S		3				35	4	24.0	5,470	3.21	3.31	3.41	3.53	3.77
HSLB 2006-010S	RO.3	1	0.48	0.59	16°	35	4	26.0	4,670	1.14	1.18	1.22	1.25	1.33
HSLB 2006-015S		1.5				35	4	25.5	4,220	1.65	1.71	1.76	1.81	1.93
HSLB 2006-020S		2				35	4	25.0	4,220	2.17	2.24	2.31	2.38	2.54
HSLB 2006-030S		3				35	4	24.0	4,330	3.21	3.31	3.41	3.52	3.76
HSLB 2006-040S		4				40	4	28.0	4,450	4.24	4.37	4.51	4.66	4.99
HSLB 2006-050S		5				40	4	27.0	4,450	5.27	5.44	5.61	5.80	6.21
HSLB 2006-060S		6				40	4	26.0	4,450	6.30	6.50	6.71	6.93	7.43
HSLB 2008-020S		RO.4				2	0.64	0.79	16°	35	4	25.5	4,220	2.17
HSLB 2008-030S	3		35	4	24.5	4,450				3.21	3.30	3.40	3.50	3.74
HSLB 2008-040S	4		35	4	23.5	4,450				4.24	4.36	4.50	4.64	4.97
HSLB 2008-060S	6		40	4	26.5	4,450				6.30	6.49	6.70	6.92	7.41

Next Page ➔

UDC Series

CBN Series

Square

Long Neck Square

Radius

Long Neck Radius

Taper Neck Radius

Ball / Long Shank Ball

Long Neck Ball

Taper Neck Ball

Taper

Spiral V Cutter

Drill

EURO Series

Technical Data

Model Number	Radius of Ball Nose R	Effective Length ℓ_1	Length of Cut ℓ	Neck Diameter ϕd_1	Shank Taper Angle Bita	Overall Length L	Shank Diameter ϕd	Shank Length H	Price ¥	Effective Length by Inclined Angles							
										30°	1°	1°30'	2°	3°			
HSLB 2010-020S	R0.5	2	0.8	0.98	16°	35	4	25.5	3,530	2.18	2.24	2.30	2.36	2.51			
HSLB 2010-025S		2.5								2.70	2.77	2.85	2.93	3.12			
HSLB 2010-030S		3								3.21	3.30	3.40	3.50	3.73			
HSLB 2010-040S		4								4.24	4.37	4.50	4.64	4.96			
HSLB 2010-060S		6								6.31	6.50	6.70	6.92	7.40			
HSLB 2010-080S		8								8.37	8.63	8.90	9.20	9.85			
HSLB 2015-030S	R0.75	3	1.2	1.47	16°	35	4	25.5	4,100	3.10	3.18	3.26	3.35	3.55			
HSLB 2015-040S		4								4.13	4.24	4.36	4.49	4.77			
HSLB 2015-060S		6								6.19	6.37	6.56	6.76	7.22			
HSLB 2015-080S		8								8.25	8.50	8.76	9.04	9.67			
HSLB 2015-100S		10								10.32	10.63	10.96	11.32	12.11			
HSLB 2020-030S	R1	3	1.6	1.98	16°	35	4	26.5	3,530	3.07	3.14	3.21	3.29	3.47			
HSLB 2020-040S		4								4.10	4.20	4.31	4.43	4.70			
HSLB 2020-060S		6								6.16	6.33	6.51	6.71	7.14			
HSLB 2020-080S		8								8.23	8.46	8.72	8.99	9.59			
HSLB 2020-100S		10								10.29	10.59	10.92	11.26	12.04			
HSLB 2020-120S		12								12.35	12.72	13.12	13.54	14.48			
HSLB 2020-140S		14								14.41	14.85	15.32	15.82	16.93			
HSLB 2020-160S		16								16.48	16.98	17.52	18.10	19.38			
HSLB 2020-200S		20								20.60	21.24	21.92	22.65	No Interference			
HSLB 2030-060-4S		R1.5								6	2.4	2.95	16°	35	4	25.0	4,330
HSLB 2030-080-4S	8		8.26	8.48	8.72	8.97	9.54										
HSLB 2030-100-4S	10		10.32	10.61	10.92	11.25	No Interference										
HSLB 2030-120-4S	12		12.38	12.74	13.12	13.53	No Interference										
HSLB 2030-160-4S	16		16.51	17.00	17.52	No Interference	No Interference										
HSLB 2030-200-4S	20		20.64	21.26	No Interference	No Interference	No Interference										
HSLB 2040-080-4S	R2	8	3.2	3.95	—	35	4	24.0	4,450	No Interference	No Interference	No Interference	No Interference	No Interference			
HSLB 2040-100-4S		10								4.0	4.28	4.450	No Interference	No Interference	No Interference	No Interference	No Interference
HSLB 2040-120-4S		12								4.0	4.26	5.810	No Interference	No Interference	No Interference	No Interference	No Interference
HSLB 2040-160-4S		16								4.5	4.27	5.810	No Interference	No Interference	No Interference	No Interference	No Interference
HSLB 2040-200-4S		20								5.0	4.28	5.810	No Interference	No Interference	No Interference	No Interference	No Interference
HSLB 2060-150S	R3	15	4.8	5.95	—	45	6	28.0	7,300	No Interference	No Interference	No Interference	No Interference	No Interference			
HSLB 2060-200S		20								5.0	6	28.0	7,300	No Interference	No Interference	No Interference	No Interference

UDC Series

CBN Series

 Square
 Long Neck Square

 Radius
 Long Neck Radius
 Taper Neck Radius

 Ball / Long Shank Ball
 Long Neck Ball
 Taper Neck Ball

Taper

Spiral V Cutter

Drill

EURO Series

Technical Data

UDC Series

CBN Series

Square

Square

Long Neck Square

Radius

Radius

Long Neck Radius

Taper Neck Radius

Ball

Ball / Long Shank Ball

Long Neck Ball

Taper Neck Ball

Taper

Taper

Spiral V Cutter

Drill

EURO Series

Technical Data



Size R0.05~R3

CSELB

Super
MG

UT
COAT

Shank Dia
0/-0.005

Back Taper
Geometry

Material Applications (☆ Highly Recommended ○ Recommended ○ Suggested)

Work Material															
Carbon Steels S45C S55C	Alloy Steels SK / SCM SUS	Prehardened Steels NAK HPM	Hardened Steels			Cast Iron	Aluminum Alloys	Graphite	Copper	Plastics	Glass Filled Plastics	Titanium Alloys	Heat Resistant Alloys	Cemented Carbide	Hard Brittle (Non-Metallic) Materials
			~55HRC	~60HRC	~70HRC										
○	○	○	○			○	○		○			○	○		

Features

The robust geometry offers durability when roughing, yet gives excellent surface quality for finishing. UTCOAT with improved hardness, durability, lubricity and adhesion offers better wear resistance and surface roughness.

Broad application range from Copper and raw materials to Hardened Steels (55HRC).

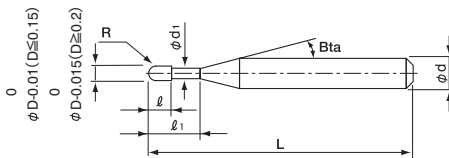

The shank taper angle shown is not an exact value and to avoid contact with the work piece, we recommend the user controls the precise value of this angle. Shank taper angle should not make contact with the work piece.

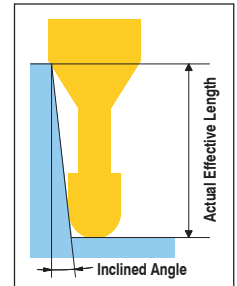

Radius of Ball Nose	Diameter Tolerance	Ball Radius Accuracy	Helix Angle
R0.05 ~ R0.075	0/-0.01	±0.002	
R0.1 ~ R3	0/-0.015	±0.005	

Total 325 models

Unit (mm)

Model Number	Radius of Ball Nose R	Effective Length ℓ_1	Length of Cut ℓ	Neck Diameter ϕd_1	Shank Taper Angle Bta	Overall Length L	Shank Diameter ϕd	Price ¥	Effective Length by Inclined Angles				
									30°	1°	1°30'	2°	3°
CSELB 2001-002	R0.05	0.2	0.08	0.095	11°	45	4	11,630	0.22	0.24	0.26	0.28	0.31
CSELB 2001-003		0.3							0.33	0.35	0.38	0.40	0.45
CSELB 2001-005		0.5							0.54	0.58	0.61	0.64	0.72
CSELB 20015-003	R0.075	0.3	0.12	0.135	11°	45	4	13,450	0.36	0.38	0.40	0.42	0.48
CSELB 20015-005		0.5							0.58	0.60	0.63	0.67	0.75
CSELB 20015-010		1							1.10	1.15	1.21	1.28	1.43

Model Number	Radius of Ball Nose R	Effective Length l_1	Length of Cut l	Neck Diameter ϕd	Shank Taper Angle Bta	Overall Length L	Shank Diameter ϕd	Price ¥	Effective Length by Inclined Angles								
									30°	1°	1°30'	2°	3°				
CSELB 2002-003	RO.1	0.3	0.16	0.19	11°	45	4	8,090	0.40	0.42	0.44	0.46	0.52				
CSELB 2002-005		0.5				45	4	8,090	0.61	0.64	0.67	0.71	0.79				
CSELB 2002-005-6		0.5				50	6	11,290	0.61	0.64	0.67	0.71	0.79				
CSELB 2002-0075		0.75				45	4	8,090	0.87	0.92	0.96	1.01	1.13				
CSELB 2002-010		1				45	4	8,090	1.14	1.19	1.25	1.32	1.48				
CSELB 2002-010-6		1				50	6	11,290	1.14	1.19	1.25	1.32	1.48				
CSELB 2002-0125		1.25				45	4	8,780	1.39	1.45	1.53	1.61	1.80				
CSELB 2002-015		1.5				45	4	8,780	1.65	1.73	1.81	1.91	2.14				
CSELB 2002-015-6		1.5				50	6	12,250	1.65	1.73	1.81	1.91	2.14				
CSELB 2002-0175		1.75				45	4	9,690	1.91	2.00	2.10	2.22	2.49				
CSELB 2002-020		2				45	4	9,690	2.17	2.28	2.39	2.52	2.83				
CSELB 2002-020-6		2				50	6	13,520	2.17	2.28	2.39	2.52	2.83				
CSELB 2002-0225		2.25				45	4	10,600	2.43	2.55	2.68	2.83	3.17				
CSELB 2002-025		2.5				45	4	10,600	2.69	2.83	2.97	3.13	3.51				
CSELB 2002-030		3				45	4	11,400	3.22	3.37	3.55	3.74	4.20				
CSELB 2003-005		RO.15				0.5	0.24	0.29	11°	45	4	7,980	0.61	0.64	0.67	0.70	0.77
CSELB 2003-006						0.6				45	4	7,980	0.71	0.75	0.78	0.82	0.91
CSELB 2003-0075						0.75				45	4	7,980	0.87	0.91	0.95	1.00	1.12
CSELB 2003-010						1				45	4	7,980	1.13	1.19	1.24	1.31	1.46
CSELB 2003-010-6						1				50	6	10,830	1.13	1.19	1.24	1.31	1.46
CSELB 2003-0125	1.25		45	4	8,550	1.38				1.45	1.52	1.60	1.78				
CSELB 2003-015	1.5		45	4	8,550	1.64				1.72	1.81	1.90	2.12				
CSELB 2003-015-6	1.5		50	6	11,860	1.64				1.72	1.81	1.90	2.12				
CSELB 2003-0175	1.75		45	4	8,550	1.91				2.00	2.10	2.21	2.47				
CSELB 2003-020	2		45	4	8,550	2.17				2.27	2.38	2.51	2.81				
CSELB 2003-020-6	2		50	6	11,860	2.17				2.27	2.38	2.51	2.81				
CSELB 2003-0225	2.25		45	4	8,780	2.43				2.55	2.67	2.82	3.15				
CSELB 2003-025	2.5		45	4	8,780	2.69				2.82	2.96	3.12	3.49				
CSELB 2003-030	3		45	4	8,780	3.22				3.37	3.54	3.73	4.18				
CSELB 2003-040	4		45	4	9,120	4.26				4.47	4.70	4.95	5.55				
CSELB 2003-050	5		45	4	10,260	5.31				5.57	5.85	6.17	6.92				
CSELB 2004-005	RO.2		0.5	0.32	0.39	11°				45	4	5,470	0.61	0.63	0.66	0.69	0.76
CSELB 2004-0075			0.75							45	4	5,470	0.87	0.91	0.95	0.99	1.10
CSELB 2004-010			1							45	4	5,470	1.13	1.18	1.24	1.30	1.44
CSELB 2004-010-6			1							50	6	7,980	1.13	1.18	1.24	1.30	1.44
CSELB 2004-0125		1.25	45				4	5,590	1.38	1.44	1.51	1.59	1.76				
CSELB 2004-015		1.5	45				4	5,590	1.64	1.72	1.80	1.89	2.11				
CSELB 2004-015-6		1.5	50				6	8,090	1.64	1.72	1.80	1.89	2.11				
CSELB 2004-0175		1.75	45				4	5,700	1.90	1.99	2.09	2.19	2.45				
CSELB 2004-020		2	45				4	5,700	2.17	2.27	2.38	2.50	2.79				
CSELB 2004-020-6		2	50				6	8,320	2.17	2.27	2.38	2.50	2.79				
CSELB 2004-0225		2.25	45				4	5,930	2.43	2.54	2.67	2.80	3.13				
CSELB 2004-025		2.5	45				4	5,930	2.69	2.82	2.95	3.11	3.48				
CSELB 2004-025-6		2.5	50				6	8,550	2.69	2.82	2.95	3.11	3.48				
CSELB 2004-030		3	45				4	6,270	3.21	3.36	3.53	3.72	4.16				
CSELB 2004-030-6		3	50				6	9,120	3.21	3.36	3.53	3.72	4.16				
CSELB 2004-035		3.5	45				4	6,840	3.74	3.91	4.11	4.33	4.85				
CSELB 2004-040		4	45				4	6,840	4.26	4.46	4.69	4.94	5.53				
CSELB 2004-040-6		4	50				6	9,300	4.26	4.46	4.69	4.94	5.53				
CSELB 2004-045		4.5	45				4	7,180	4.78	5.01	5.27	5.55	6.21				
CSELB 2004-050		5	45				4	7,180	5.31	5.56	5.84	6.16	6.90				
CSELB 2004-060	6	45	4	8,320	6.35	6.66	7.00	7.38	8.27								

UDC Series

CBN Series

Square

Long Neck Square

Radius

Long Neck Radius

Taper Neck Radius

Ball / Long Shank Ball

Long Neck Ball

Taper Neck Ball

Taper

Spiral V Cutter

Drill

EURO Series

Technical Data

Model Number	Radius of Ball Nose R	Effective Length ℓ_1	Length of Cut ℓ	Neck Diameter ϕd_1	Shank Taper Angle Bia	Overall Length L	Shank Diameter ϕd	Price ¥	Effective Length by Inclined Angles				
									30°	1°	1°30'	2°	3°
CSELB 2005-010	R0.25	1	0.4	0.49	11°	45	4	5,470	1.13	1.17	1.23	1.28	1.42
CSELB 2005-0125		1.25				45	4	5,470	1.38	1.43	1.50	1.57	1.74
CSELB 2005-015		1.5				45	4	5,470	1.64	1.71	1.79	1.88	2.09
CSELB 2005-015-6		1.5				50	6	7,980	1.64	1.71	1.79	1.88	2.09
CSELB 2005-0175		1.75				45	4	5,470	1.90	1.98	2.08	2.18	2.43
CSELB 2005-020		2				45	4	5,470	2.16	2.26	2.37	2.49	2.77
CSELB 2005-020-6		2				50	6	7,980	2.16	2.26	2.37	2.49	2.77
CSELB 2005-0225		2.25				45	4	5,470	2.42	2.53	2.65	2.79	3.11
CSELB 2005-025		2.5				45	4	5,470	2.68	2.81	2.94	3.10	3.45
CSELB 2005-025-6		2.5				50	6	7,980	2.68	2.81	2.94	3.10	3.45
CSELB 2005-030		3				45	4	5,470	3.21	3.36	3.52	3.70	4.14
CSELB 2005-030-6		3				50	6	7,980	3.21	3.36	3.52	3.70	4.14
CSELB 2005-035		3.5				45	4	5,470	3.73	3.91	4.10	4.31	4.82
CSELB 2005-040		4				45	4	5,470	4.25	4.46	4.68	4.92	5.51
CSELB 2005-040-6		4				50	6	7,980	4.25	4.46	4.68	4.92	5.51
CSELB 2005-045		4.5				45	4	5,590	4.78	5.00	5.26	5.53	6.19
CSELB 2005-050		5				45	4	5,590	5.30	5.55	5.83	6.14	6.88
CSELB 2005-055		5.5				45	4	5,700	5.83	6.10	6.41	6.75	7.56
CSELB 2005-060		6				45	4	5,700	6.35	6.65	6.99	7.36	8.25
CSELB 2005-070		7				45	4	6,840	7.40	7.75	8.14	8.58	9.62
CSELB 2005-080	8	45	4	6,840	8.44	8.85	9.30	9.80	10.99				
CSELB 2005-090	9	45	4	7,980	9.49	9.95	10.46	11.02	12.35				
CSELB 2005-100	10	50	4	8,500	10.54	11.05	11.61	12.24	13.72				
CSELB 2006-010	R0.3	1	0.48	0.59	11°	45	4	4,670	1.12	1.17	1.22	1.27	1.40
CSELB 2006-0125		1.25				45	4	4,220	1.37	1.43	1.49	1.56	1.73
CSELB 2006-015		1.5				45	4	4,220	1.63	1.70	1.78	1.87	2.07
CSELB 2006-015-6		1.5				50	6	6,380	1.63	1.70	1.78	1.87	2.07
CSELB 2006-0175		1.75				45	4	4,220	1.90	1.98	2.07	2.17	2.41
CSELB 2006-020		2				45	4	4,220	2.16	2.25	2.36	2.48	2.75
CSELB 2006-020-6		2				50	6	6,380	2.16	2.25	2.36	2.48	2.75
CSELB 2006-0225		2.25				45	4	4,330	2.42	2.53	2.65	2.78	3.09
CSELB 2006-025		2.5				45	4	4,330	2.68	2.80	2.94	3.08	3.44
CSELB 2006-025-6		2.5				50	6	6,380	2.68	2.80	2.94	3.08	3.44
CSELB 2006-030		3				45	4	4,330	3.21	3.35	3.51	3.69	4.12
CSELB 2006-030-6		3				50	6	6,500	3.21	3.35	3.51	3.69	4.12
CSELB 2006-035		3.5				45	4	4,450	3.73	3.90	4.09	4.30	4.81
CSELB 2006-040		4				45	4	4,450	4.25	4.45	4.67	4.91	5.49
CSELB 2006-040-6		4				50	6	6,730	4.25	4.45	4.67	4.91	5.49
CSELB 2006-045		4.5				45	4	4,450	4.78	5.00	5.25	5.52	6.18
CSELB 2006-050		5				45	4	4,450	5.30	5.55	5.83	6.13	6.86
CSELB 2006-050-6		5				50	6	6,730	5.30	5.55	5.83	6.13	6.86
CSELB 2006-055		5.5				45	4	4,450	5.82	6.10	6.40	6.74	7.54
CSELB 2006-060		6				45	4	4,450	6.35	6.65	6.98	7.35	8.23
CSELB 2006-060-6	6	50	6	6,730	6.35	6.65	6.98	7.35	8.23				
CSELB 2006-065	6.5	45	4	5,020	6.87	7.20	7.56	7.96	8.91				
CSELB 2006-070	7	45	4	5,020	7.39	7.75	8.14	8.57	9.60				
CSELB 2006-080	8	45	4	5,930	8.44	8.85	9.29	9.79	10.97				
CSELB 2006-080-6	8	50	6	8,550	8.44	8.85	9.29	9.79	10.97				
CSELB 2006-090	9	45	4	6,270	9.49	9.94	10.45	11.01	12.34				
CSELB 2006-100	10	50	4	6,040	10.53	11.04	11.60	12.23	13.71				
CSELB 2006-100-6	10	50	6	9,120	10.53	11.04	11.60	12.23	13.71				
CSELB 2006-120	12	50	4	6,840	12.63	13.24	13.92	14.66	16.44				

- UDC Series
- CBN Series
- Square
- Long Neck Square
- Radius
- Long Neck Radius
- Taper Neck Radius
- Ball / Long Shank Ball
- Long Neck Ball
- Taper Neck Ball
- Taper
- Spiral V Cutter
- Drill
- EURO Series
- Technical Data

Unit (mm)

Model Number	Radius of Ball Nose R	Effective Length l_1	Length of Cut l	Neck Diameter ϕd	Shank Taper Angle β	Overall Length L	Shank Diameter ϕd	Price ¥	Effective Length by Inclined Angles				
									30°	1°	1°30'	2°	3°
CSELB 2007-020	RO.35	2	0.56	0.69	11°	45	4	4,220	2.16	2.25	2.35	2.46	2.73
CSELB 2007-040		4				45	4	4,450	4.25	4.45	4.66	4.90	5.47
CSELB 2007-060		6				45	4	4,450	6.34	6.64	6.97	7.34	8.21
CSELB 2007-080		8				45	4	4,450	8.44	8.84	9.28	9.78	10.95
CSELB 2008-020	RO.4	2	0.64	0.79	11°	45	4	4,220	2.15	2.24	2.34	2.45	2.72
CSELB 2008-020-6		2				50	6	6,380	2.15	2.24	2.34	2.45	2.72
CSELB 2008-030		3				45	4	4,450	3.20	3.34	3.50	3.67	4.09
CSELB 2008-030-6		3				50	6	6,730	3.20	3.34	3.50	3.67	4.09
CSELB 2008-040		4				45	4	4,450	4.25	4.44	4.65	4.89	5.45
CSELB 2008-040-6		4				50	6	6,730	4.25	4.44	4.65	4.89	5.45
CSELB 2008-050		5				45	4	4,450	5.29	5.54	5.81	6.11	6.82
CSELB 2008-060		6				45	4	4,450	6.34	6.64	6.97	7.33	8.19
CSELB 2008-060-6		6				50	6	6,730	6.34	6.64	6.97	7.33	8.19
CSELB 2008-070		7				45	4	4,450	7.39	7.74	8.12	8.55	9.56
CSELB 2008-080		8				45	4	4,450	8.44	8.84	9.28	9.77	10.93
CSELB 2008-080-6		8				50	6	6,730	8.44	8.84	9.28	9.77	10.93
CSELB 2008-090		9				45	4	5,930	9.48	9.93	10.43	10.99	12.30
CSELB 2008-100		10				50	4	5,930	10.53	11.03	11.59	12.21	13.67
CSELB 2008-100-6		10				50	6	8,550	10.53	11.03	11.59	12.21	13.67
CSELB 2008-120		12				45	4	7,300	12.62	13.23	13.90	14.64	16.41
CSELB 2008-160	16	50	4	9,990	16.81	17.62	18.52	19.52	21.88				
CSELB 2009-020	RO.45	2	0.72	0.89	11°	45	4	4,220	2.15	2.24	2.34	2.44	2.70
CSELB 2009-040		4				45	4	4,450	4.25	4.44	4.65	4.88	5.44
CSELB 2009-060		6				45	4	4,450	6.34	6.63	6.96	7.32	8.17
CSELB 2009-080		8				45	4	4,450	8.43	8.83	9.27	9.76	10.91
CSELB 2009-100		10				45	4	5,930	10.53	11.03	11.58	12.19	13.65
CSELB 2009-120		12				45	4	7,300	12.62	13.23	13.89	14.63	16.39
CSELB 2009-140		14				50	4	8,460	14.72	15.42	16.20	17.07	19.13
CSELB 2009-160		16				50	4	9,990	16.81	17.62	18.51	19.51	21.87
CSELB 2009-180		18				55	4	9,990	18.90	19.82	20.83	21.95	24.60

Next Page →

UDC Series

CBN Series

Square

Long Neck Square

Radius

Long Neck Radius

Taper Neck Radius

Ball / Long Shank Ball

Long Neck Ball

Taper Neck Ball

Taper

Spiral V Cutter

Drill

EURO Series

Technical Data

Model Number	Radius of Ball Nose R	Effective Length ℓ_1	Length of Cut ℓ	Neck Diameter ϕd_i	Shank Taper Angle Bia	Overall Length L	Shank Diameter ϕd	Price ¥	Effective Length by Inclined Angles				
									30°	1°	1°30'	2°	3°
CSELB 2010-020	RO.5	2	0.8	0.98	11°	45	4	3,530	2.17	2.25	2.35	2.45	2.70
CSELB 2010-025		2.5				45	4	3,530	2.69	2.80	2.92	3.06	3.39
CSELB 2010-030		3				45	4	3,530	3.21	3.35	3.50	3.67	4.07
CSELB 2010-030-6		3				50	6	5,590	3.21	3.35	3.50	3.67	4.07
CSELB 2010-040		4				45	4	3,990	4.26	4.45	4.66	4.89	5.44
CSELB 2010-040-6		4				50	6	6,160	4.26	4.45	4.66	4.89	5.44
CSELB 2010-050		5				45	4	3,990	5.31	5.55	5.81	6.11	6.81
CSELB 2010-050-6		5				50	6	6,160	5.31	5.55	5.81	6.11	6.81
CSELB 2010-060		6				45	4	4,330	6.35	6.65	6.97	7.33	8.18
CSELB 2010-060-6		6				50	6	6,500	6.35	6.65	6.97	7.33	8.18
CSELB 2010-070		7				45	4	4,330	7.40	7.74	8.12	8.55	9.55
CSELB 2010-070-6		7				50	6	6,500	7.40	7.74	8.12	8.55	9.55
CSELB 2010-080		8				45	4	4,330	8.45	8.84	9.28	9.76	10.92
CSELB 2010-080-6		8				50	6	6,500	8.45	8.84	9.28	9.76	10.92
CSELB 2010-090		9				45	4	4,330	9.49	9.94	10.44	10.98	12.29
CSELB 2010-100		10				45	4	4,330	10.54	11.04	11.59	12.20	13.65
CSELB 2010-100-6		10				50	6	6,500	10.54	11.04	11.59	12.20	13.65
CSELB 2010-120		12				45	4	4,330	12.64	13.24	13.90	14.64	16.39
CSELB 2010-120-6		12				50	6	6,500	12.64	13.24	13.90	14.64	16.39
CSELB 2010-140		14				50	4	5,020	14.73	15.43	16.21	17.08	19.13
CSELB 2010-140-6	14	60	6	7,070	14.73	15.43	16.21	17.08	19.13				
CSELB 2010-160	16	50	4	5,930	16.82	17.63	18.53	19.52	21.87				
CSELB 2010-160-6	16	60	6	8,550	16.82	17.63	18.53	19.52	21.87				
CSELB 2010-180	18	55	4	5,930	18.92	19.83	20.84	21.95	24.61				
CSELB 2010-200	20	55	4	7,180	21.01	22.03	23.15	24.39	27.35				
CSELB 2010-200-6	20	70	6	10,150	21.01	22.03	23.15	24.39	27.35				
CSELB 2010-220-6	22	70	6	10,600	23.11	24.22	25.46	26.83	30.08				
CSELB 2012-025	RO.6	2.5	0.96	1.19	11°	45	4	5,360	2.58	2.68	2.80	2.92	3.22
CSELB 2012-040		4				45	4	5,360	4.15	4.33	4.53	4.75	5.27
CSELB 2012-060		6				45	4	5,810	6.25	6.53	6.84	7.19	8.01
CSELB 2012-060-6		6				50	6	8,270	6.25	6.53	6.84	7.19	8.01
CSELB 2012-080		8				45	4	5,810	8.34	8.73	9.15	9.63	10.75
CSELB 2012-080-6		8				50	6	8,270	8.34	8.73	9.15	9.63	10.75
CSELB 2012-100		10				45	4	5,810	10.44	10.92	11.46	12.06	13.49
CSELB 2012-100-6		10				50	6	8,270	10.44	10.92	11.46	12.06	13.49
CSELB 2012-120		12				45	4	5,810	12.53	13.12	13.78	14.50	16.23
CSELB 2012-120-6		12				50	6	8,270	12.53	13.12	13.78	14.50	16.23
CSELB 2012-140		14				50	4	6,270	14.62	15.32	16.09	16.94	18.96
CSELB 2012-160		16				50	4	6,840	16.72	17.52	18.40	19.38	21.70
CSELB 2012-160-6		16				60	6	9,410	16.72	17.52	18.40	19.38	21.70
CSELB 2012-180		18				55	4	7,410	18.81	19.71	20.71	21.82	24.44
CSELB 2012-200		20				60	4	7,410	20.91	21.91	23.02	24.25	27.18

UDC Series

CBN Series

Square
Long Neck Square

Radius
Long Neck Radius
Taper Neck Radius

Ball / Long Shank Ball
Long Neck Ball
Taper Neck Ball

Taper
Spiral V Cutter

Drill

EURO Series

Technical Data

Unit (mm)

Model Number	Radius of Ball Nose R	Effective Length l_1	Length of Cut l	Neck Diameter ϕd	Shank Taper Angle Bta	Overall Length L	Shank Diameter ϕd	Price ¥	Effective Length by Inclined Angles				
									30°	1°	1°30'	2°	3°
CSELB 2014-060	RO.7	6	1.12	1.37	11°	45	4	5,020	6.30	6.58	6.89	7.23	8.04
CSELB 2014-080		8				45	4	5,020	8.39	8.77	9.20	9.67	10.78
CSELB 2014-120		12				45	4	5,020	12.58	13.17	13.82	14.54	16.26
CSELB 2014-160		16				50	4	5,020	16.77	17.56	18.44	19.42	21.74
CSELB 2015-030	RO.75	3	1.2	1.47	11°	45	4	4,100	3.15	3.28	3.41	3.56	3.92
CSELB 2015-040		4				45	4	4,100	4.20	4.37	4.57	4.78	5.29
CSELB 2015-060		6				45	4	4,100	6.29	6.57	6.88	7.22	8.03
CSELB 2015-060-6		6				50	6	6,610	6.29	6.57	6.88	7.22	8.03
CSELB 2015-080		8				45	4	4,330	8.39	8.77	9.19	9.66	10.77
CSELB 2015-080-6		8				50	6	6,610	8.39	8.77	9.19	9.66	10.77
CSELB 2015-100		10				45	4	4,670	10.48	10.97	11.50	12.09	13.50
CSELB 2015-100-6		10				50	6	6,610	10.48	10.97	11.50	12.09	13.50
CSELB 2015-120		12				45	4	5,020	12.58	13.16	13.81	14.53	16.24
CSELB 2015-120-6		12				50	6	7,520	12.58	13.16	13.81	14.53	16.24
CSELB 2015-140		14				50	4	5,020	14.67	15.36	16.12	16.97	18.98
CSELB 2015-160		16				50	4	5,020	16.76	17.56	18.43	19.41	21.72
CSELB 2015-160-6		16				60	6	7,520	16.76	17.56	18.43	19.41	21.72
CSELB 2015-180		18				55	4	5,020	18.86	19.76	20.75	21.85	24.46
CSELB 2015-200		20				55	4	5,020	20.95	21.95	23.06	24.28	No Interference
CSELB 2015-200-6		20				60	6	7,520	20.95	21.95	23.06	24.28	27.19
CSELB 2015-220		22				55	4	5,020	23.05	24.15	25.37	26.72	No Interference
CSELB 2015-250		25				65	4	7,000	26.19	27.45	28.84	30.38	No Interference
CSELB 2015-300		30				70	4	8,210	31.42	32.94	34.61	36.47	No Interference
CSELB 2016-040		RO.8				4	1.28	1.58	11°	45	4	5,700	4.17
CSELB 2016-080	8		45	4	5,810	8.36				8.74	9.15	9.61	10.71
CSELB 2016-120	12		45	4	5,810	12.55				13.13	13.77	14.49	16.19
CSELB 2016-160	16		50	4	5,810	16.74				17.53	18.40	19.37	21.66
CSELB 2016-200	20		55	4	5,810	20.92				21.92	23.02	24.24	No Interference
CSELB 2018-040	RO.9	4	1.44	1.78	11°	45	4	4,750	4.17	4.33	4.51	4.72	5.20
CSELB 2018-060		6				45	4	4,750	6.26	6.53	6.83	7.15	7.94
CSELB 2018-080		8				45	4	5,020	8.35	8.73	9.14	9.59	10.68
CSELB 2018-100		10				45	4	5,020	10.45	10.92	11.45	12.03	13.41
CSELB 2018-120		12				45	4	5,020	12.54	13.12	13.76	14.47	16.15
CSELB 2018-160		16				50	4	5,020	16.73	17.52	18.38	19.34	21.63
CSELB 2018-180		18				55	4	5,020	18.82	19.71	20.69	21.78	No Interference
CSELB 2018-200		20				55	4	5,020	20.92	21.91	23.00	24.22	No Interference
CSELB 2018-220		22				60	4	6,870	23.01	24.11	25.32	26.66	No Interference
CSELB 2018-250		25				65	4	7,000	26.15	27.40	28.78	30.32	No Interference
CSELB 2018-300		30				70	4	7,930	31.39	32.90	34.56	No Interference	No Interference

- UDC Series
- CBN Series
- Square
- Long Neck Square
- Radius
- Long Neck Radius
- Taper Neck Radius
- Ball / Long Shank Ball
- Long Neck Ball
- Taper Neck Ball
- Taper
- Spiral V Cutter
- Drill
- EURO Series
- Technical Data

Model Number	Radius of Ball Nose R	Effective Length l_1	Length of Cut l	Neck Diameter ϕd_1	Shank Taper Angle Bia	Overall Length L	Shank Diameter ϕd	Price ¥	Effective Length by Inclined Angles				
									30°	1°	1°30'	2°	3°
CSELB 2020-030	R1	3	1.6	1.98	11°	45	4	3,530	3.11	3.22	3.34	3.48	3.79
CSELB 2020-040		4				45	4	3,530	4.16	4.32	4.50	4.70	5.16
CSELB 2020-040-6		4				50	6	5,590	4.16	4.32	4.50	4.70	5.16
CSELB 2020-060		6				45	4	3,990	6.26	6.52	6.81	7.13	7.90
CSELB 2020-060-6		6				50	6	6,040	6.26	6.52	6.81	7.13	7.90
CSELB 2020-080		8				45	4	4,330	8.35	8.72	9.12	9.57	10.64
CSELB 2020-080-6		8				50	6	6,500	8.35	8.72	9.12	9.57	10.64
CSELB 2020-100		10				45	4	4,330	10.44	10.91	11.43	12.01	13.38
CSELB 2020-100-6		10				50	6	6,500	10.44	10.91	11.43	12.01	13.38
CSELB 2020-120		12				45	4	4,330	12.54	13.11	13.74	14.45	16.12
CSELB 2020-120-6		12				50	6	6,500	12.54	13.11	13.74	14.45	16.12
CSELB 2020-130		13				45	4	4,330	13.59	14.21	14.90	15.67	17.49
CSELB 2020-140		14				50	4	4,330	14.63	15.31	16.06	16.89	18.85
CSELB 2020-160		16				50	4	4,330	16.73	17.51	18.37	19.32	No Interference
CSELB 2020-160-6		16				60	6	6,500	16.73	17.51	18.37	19.32	21.59
CSELB 2020-180		18				55	4	4,330	18.82	19.70	20.68	21.76	No Interference
CSELB 2020-200		20				55	4	4,330	20.91	21.90	22.99	24.20	No Interference
CSELB 2020-200-6		20				70	6	6,500	20.91	21.90	22.99	24.20	27.07
CSELB 2020-220		22				60	4	5,930	23.01	24.10	25.30	26.64	No Interference
CSELB 2020-250		25				65	4	6,040	26.15	27.39	28.77	No Interference	No Interference
CSELB 2020-250-6	25	80	6	8,550	26.15	27.39	28.77	30.29	33.92				
CSELB 2020-270	27	65	4	6,040	28.24	29.59	31.08	No Interference	No Interference				
CSELB 2020-300	30	70	4	6,840	31.38	32.89	34.55	No Interference	No Interference				
CSELB 2020-300-6	30	80	6	9,690	31.38	32.89	34.55	36.39	No Interference				
CSELB 2020-320	32	70	4	6,840	33.48	35.08	36.86	No Interference	No Interference				
CSELB 2020-350	35	80	4	9,350	36.62	38.38	No Interference	No Interference	No Interference				
CSELB 2020-350-6	35	80	6	12,650	36.62	38.38	40.32	42.48	No Interference				
CSELB 2020-400	40	80	4	9,350	41.85	43.87	No Interference	No Interference	No Interference				
CSELB 2020-400-6	40	90	6	12,650	41.85	43.87	46.10	48.58	No Interference				
CSELB 2025-060	R1.25	6	2	2.45	11°	45	4	4,670	6.33	6.58	6.86	7.17	7.92
CSELB 2025-080		8				45	4	4,700	8.42	8.78	9.17	9.61	10.66
CSELB 2025-100		10				45	4	4,900	10.51	10.97	11.48	12.05	13.39
CSELB 2025-150		15				50	4	5,810	15.75	16.47	17.26	18.14	No Interference
CSELB 2025-200		20				55	4	6,840	20.98	21.96	23.04	No Interference	No Interference
CSELB 2025-250		25				65	4	7,300	26.22	27.45	28.82	No Interference	No Interference
CSELB 2025-300		30				70	4	7,300	31.45	32.95	No Interference	No Interference	No Interference
CSELB 2025-350		35				70	4	8,440	36.69	38.44	No Interference	No Interference	No Interference

Next Page ➔

Model Number	Radius of Ball Nose R	Effective Length l_1	Length of Cut l	Neck Diameter ϕd	Shank Taper Angle β	Overall Length L	Shank Diameter ϕd	Price ¥	Effective Length by Inclined Angles							
									30°	1°	1°30'	2°	3°			
CSELB 2030-060	R1.5	6	2.4	2.95	11°	60	6	4,330	6.31	6.55	6.82	7.12	7.83			
CSELB 2030-060-3		6			—	60	3	3,990	No Interference	No Interference	No Interference	No Interference	No Interference			
CSELB 2030-060-4		6			60	4	3,990	6.31	6.55	6.82	7.12	7.83				
CSELB 2030-080		8			60	6	4,330	8.41	8.75	9.13	9.56	10.57				
CSELB 2030-100		10			60	6	5,020	10.50	10.95	11.44	12.00	13.30				
CSELB 2030-120		12			60	6	5,240	12.60	13.15	13.76	14.43	16.04				
CSELB 2030-140		14			60	6	5,810	14.69	15.34	16.07	16.87	18.78				
CSELB 2030-150		15			60	6	5,700	15.74	16.44	17.22	18.09	20.15				
CSELB 2030-160		16			60	6	5,810	16.78	17.54	18.38	19.31	21.52				
CSELB 2030-180		18			60	6	5,810	18.88	19.74	20.69	21.75	24.26				
CSELB 2030-200		20			70	6	5,590	20.97	21.94	23.00	24.19	27.00				
CSELB 2030-220		22			70	6	5,590	23.07	24.13	25.31	26.62	29.73				
CSELB 2030-250		25			70	6	5,590	26.21	27.43	28.78	30.28	No Interference				
CSELB 2030-270		27			70	6	5,590	28.30	29.63	31.09	32.72	No Interference				
CSELB 2030-300		30			70	6	6,380	31.44	32.92	34.56	36.38	No Interference				
CSELB 2030-320		32			80	6	8,090	33.54	35.12	36.87	38.81	No Interference				
CSELB 2030-350		35			80	6	8,090	36.68	38.42	40.34	42.47	No Interference				
CSELB 2030-400		40			80	6	10,030	41.91	43.91	46.12	No Interference	No Interference				
CSELB 2035-100		R1.75			10	2.8	3.45	11°	60	6	6,380	10.49	10.93	11.41	11.94	13.21
CSELB 2035-150					15				60	6	6,380	15.72	16.42	17.19	18.04	20.06
CSELB 2035-200	20		65	6	6,840				20.96	21.91	22.96	24.13	No Interference			
CSELB 2035-250	25		70	6	6,840				26.19	27.40	28.74	30.23	No Interference			
CSELB 2035-300	30		70	6	7,300				31.43	32.90	34.52	36.32	No Interference			
CSELB 2035-400	40		90	6	9,690				41.90	43.88	46.08	No Interference	No Interference			
CSELB 2035-450	45		90	6	10,600				47.13	49.38	No Interference	No Interference	No Interference			
CSELB 2040-080	R2		8	3.2	3.95				11°	70	6	4,450	8.38	8.70	9.06	9.45
CSELB 2040-080-4		8	—			70	4	4,180	No Interference	No Interference	No Interference	No Interference	No Interference			
CSELB 2040-100		10	70			6	4,450	10.48	10.90	11.37	11.89	13.12				
CSELB 2040-120		12	70			6	5,810	12.57	13.10	13.68	14.33	15.86				
CSELB 2040-140		14	70			6	5,810	14.67	15.30	15.99	16.76	18.60				
CSELB 2040-150		15	70			6	5,810	15.71	16.39	17.15	17.98	19.97				
CSELB 2040-160		16	70			6	5,810	16.76	17.49	18.30	19.20	No Interference				
CSELB 2040-180		18	70			6	5,810	18.85	19.69	20.61	21.64	No Interference				
CSELB 2040-200		20	70			6	5,810	20.95	21.89	22.93	24.08	No Interference				
CSELB 2040-220		22	70			6	5,810	23.04	24.08	25.24	26.52	No Interference				
CSELB 2040-250		25	70			6	5,810	26.18	27.38	28.70	30.17	No Interference				
CSELB 2040-270		27	70			6	5,810	28.28	29.58	31.01	No Interference	No Interference				
CSELB 2040-300		30	70			6	5,810	31.42	32.87	34.48	No Interference	No Interference				
CSELB 2040-320		32	80			6	6,730	33.51	35.07	36.79	No Interference	No Interference				
CSELB 2040-350		35	80			6	6,730	36.65	38.37	40.26	No Interference	No Interference				
CSELB 2040-400		40	90			6	7,520	41.89	43.86	No Interference	No Interference	No Interference				
CSELB 2040-450		45	90			6	9,690	47.12	49.35	No Interference	No Interference	No Interference				
CSELB 2040-500		50	100			6	10,370	52.36	54.85	No Interference	No Interference	No Interference				
CSELB 2040-600		60	120			6	10,580	62.83	No Interference	No Interference	No Interference	No Interference				

- UDC Series
- CBN Series
- Square
- Long Neck Square
- Radius
- Long Neck Radius
- Taper Neck Radius
- Ball / Long Shank Ball
- Long Neck Ball
- Taper Neck Ball
- Taper
- Spiral V Cutter
- Drill
- EURO Series
- Technical Data

Model Number	Radius of Ball Nose R	Effective Length ℓ_1	Length of Cut ℓ	Neck Diameter ϕd_i	Shank Taper Angle Bia	Overall Length L	Shank Diameter ϕd	Price ¥	Effective Length by Inclined Angles				
									30°	1°	1°30'	2°	3°
CSELB 2050-100	R2.5	10	4	4.95	11°	70	6	6,840	10.45	10.85	11.29	11.78	No Interference
CSELB 2050-150		15				70	6	9,690	15.69	16.35	17.07	No Interference	No Interference
CSELB 2050-200		20				70	6	9,690	20.92	21.84	No Interference	No Interference	No Interference
CSELB 2050-250		25				70	6	9,690	26.16	27.33	No Interference	No Interference	No Interference
CSELB 2050-300		30				80	6	10,370	31.39	No Interference	No Interference	No Interference	No Interference
CSELB 2050-350		35				80	6	10,370	36.63	No Interference	No Interference	No Interference	No Interference
CSELB 2050-400		40				90	6	13,110	41.86	No Interference	No Interference	No Interference	No Interference
CSELB 2050-450		45				100	6	13,680	47.10	No Interference	No Interference	No Interference	No Interference
CSELB 2050-500		50				100	6	14,820	52.33	No Interference	No Interference	No Interference	No Interference
CSELB 2060-100		R3				10	4.8	5.95	—	80	6	7,300	No Interference
CSELB 2060-150	15		80	6	7,300	No Interference				No Interference	No Interference	No Interference	No Interference
CSELB 2060-180	18		80	6	7,300	No Interference				No Interference	No Interference	No Interference	No Interference
CSELB 2060-200	20		80	6	7,300	No Interference				No Interference	No Interference	No Interference	No Interference
CSELB 2060-220	22		80	6	7,300	No Interference				No Interference	No Interference	No Interference	No Interference
CSELB 2060-250	25		80	6	7,300	No Interference				No Interference	No Interference	No Interference	No Interference
CSELB 2060-270	27		80	6	7,300	No Interference				No Interference	No Interference	No Interference	No Interference
CSELB 2060-300	30		80	6	7,520	No Interference				No Interference	No Interference	No Interference	No Interference
CSELB 2060-320	32		80	6	7,520	No Interference				No Interference	No Interference	No Interference	No Interference
CSELB 2060-350	35		80	6	7,750	No Interference				No Interference	No Interference	No Interference	No Interference
CSELB 2060-400	40		90	6	8,210	No Interference				No Interference	No Interference	No Interference	No Interference
CSELB 2060-450	45		100	6	8,780	No Interference				No Interference	No Interference	No Interference	No Interference
CSELB 2060-500	50		120	6	8,890	No Interference				No Interference	No Interference	No Interference	No Interference
CSELB 2060-600	60		120	6	9,420	No Interference				No Interference	No Interference	No Interference	No Interference

UDC Series

CBN Series

Square
Long Neck Square

Radius
Long Neck Radius
Taper Neck Radius

Ball / Long Shank Ball
Long Neck Ball
Taper Neck Ball

Taper

Spiral V Cutter

Drill

EURO Series

Technical Data

Milling Conditions for CSELB

WORK MATERIAL		COPPER / ALUMINUM ALLOYS					CARBON STEELS / ALLOY STEELS S45C / S50C / SK / SCM (~325HB)				PREHARDENED STEELS NAK80 / STAVAX / HPM38 (30~45HRC)				HARDENED STEELS STAVAX / HPM38 / SKD61 (45~55HRC)				
Model Number	Radius of Ball Nose (mm)	Effective Length (mm)	Spindle Speed (min ⁻¹)	Feed Rate (mm/min)	a _p Axial Depth (mm)	a _e Radial Depth (mm)	Spindle Speed (min ⁻¹)	Feed Rate (mm/min)	a _p Axial Depth (mm)	a _e Radial Depth (mm)	Spindle Speed (min ⁻¹)	Feed Rate (mm/min)	a _p Axial Depth (mm)	a _e Radial Depth (mm)	Spindle Speed (min ⁻¹)	Feed Rate (mm/min)	a _p Axial Depth (mm)	a _e Radial Depth (mm)	
2001-002	R0.05	0.2	54,000	85	0.004	0.004	54,000	85	0.004	0.004	48,000	55	0.002	0.002	48,000	55	0.002	0.002	
2001-003		0.3	54,000	85	0.004	0.004	54,000	85	0.004	0.004	48,000	55	0.002	0.002	48,000	55	0.002	0.002	
2001-005		0.5	54,000	75	0.004	0.004	54,000	75	0.004	0.004	48,000	35	0.002	0.002	48,000	35	0.002	0.002	
20015-003	R0.075	0.3	54,000	160	0.007	0.009	54,000	160	0.007	0.009	48,000	90	0.004	0.004	48,000	90	0.004	0.004	
20015-005		0.5	54,000	140	0.007	0.009	54,000	140	0.007	0.009	48,000	60	0.004	0.004	48,000	60	0.004	0.004	
20015-010		1	54,000	100	0.003	0.005	54,000	100	0.003	0.005	48,000	60	0.001	0.002	48,000	60	0.001	0.002	
2002-003	R0.1	0.3	60,000	350	0.008	0.024	60,000	350	0.008	0.016	60,000	300	0.008	0.024	60,000	300	0.006	0.018	
2002-005		0.5	60,000	350	0.008	0.024	60,000	350	0.008	0.016	60,000	300	0.008	0.024	60,000	300	0.006	0.018	
2002-0075		0.75	60,000	300	0.007	0.021	60,000	320	0.007	0.015	60,000	300	0.007	0.021	60,000	270	0.005	0.015	
2002-010		1	60,000	250	0.006	0.018	60,000	250	0.005	0.015	60,000	250	0.006	0.018	60,000	220	0.005	0.015	
2002-0125		1.25	54,000	225	0.005	0.016	54,000	215	0.004	0.013	60,000	225	0.005	0.016	54,000	195	0.004	0.013	
2002-015		1.5	48,000	200	0.005	0.015	48,000	180	0.004	0.012	60,000	200	0.005	0.015	48,000	170	0.004	0.012	
2002-0175		1.75	48,000	175	0.004	0.012	48,000	165	0.003	0.01	60,000	175	0.004	0.012	48,000	145	0.003	0.009	
2002-020		2	48,000	150	0.003	0.009	48,000	150	0.003	0.009	60,000	150	0.003	0.009	48,000	120	0.003	0.007	
2002-0225		2.25	44,000	125	0.003	0.007	44,000	125	0.003	0.007	53,000	125	0.002	0.007	44,000	110	0.002	0.005	
2002-025		2.5	40,000	100	0.003	0.006	40,000	100	0.003	0.006	46,000	100	0.002	0.006	40,000	100	0.002	0.004	
2002-030		3	33,000	50	0.002	0.003	33,000	50	0.002	0.003	33,000	50	0.002	0.003	33,000	50	0.002	0.002	
2003-005		R0.15	0.5	43,000	500	0.012	0.036	43,000	500	0.012	0.024	54,000	450	0.012	0.036	43,000	450	0.008	0.024
2003-006			0.6	43,000	500	0.012	0.036	43,000	500	0.012	0.024	54,000	450	0.012	0.036	43,000	450	0.008	0.024
2003-0075			0.75	43,000	500	0.012	0.036	43,000	500	0.012	0.024	54,000	450	0.012	0.036	43,000	450	0.008	0.024
2003-010			1	43,000	450	0.01	0.03	43,000	450	0.008	0.024	54,000	400	0.01	0.03	43,000	400	0.007	0.021
2003-0125	1.25		43,000	425	0.009	0.027	43,000	425	0.007	0.022	54,000	400	0.009	0.027	43,000	400	0.006	0.019	
2003-015	1.5		43,000	400	0.008	0.024	43,000	400	0.007	0.021	54,000	400	0.008	0.024	43,000	400	0.006	0.018	
2003-0175	1.75		41,500	350	0.007	0.021	41,500	350	0.006	0.019	52,000	350	0.007	0.022	41,500	350	0.005	0.016	
2003-020	2		40,000	300	0.006	0.018	40,000	300	0.006	0.018	50,000	300	0.007	0.021	40,000	300	0.005	0.015	
2003-0225	2.25		40,000	275	0.005	0.016	40,000	275	0.005	0.016	48,000	275	0.006	0.018	40,000	275	0.004	0.013	
2003-025	2.5		40,000	250	0.005	0.015	40,000	250	0.005	0.015	46,000	250	0.005	0.015	40,000	250	0.004	0.012	
2003-030	3		38,000	200	0.004	0.012	38,000	200	0.004	0.012	42,000	200	0.004	0.012	38,000	200	0.004	0.008	
2003-040	4		35,000	100	0.003	0.009	35,000	100	0.003	0.009	35,000	100	0.003	0.009	32,000	100	0.003	0.005	
2003-050	5		26,000	60	0.003	0.004	26,000	60	0.003	0.004	26,000	60	0.003	0.004	26,000	60	0.003	0.003	
2004-005	R0.2		0.5	35,000	1,200	0.03	0.09	35,000	1,200	0.02	0.04	50,000	650	0.025	0.075	35,000	650	0.015	0.045
2004-0075			0.75	35,000	1,200	0.03	0.09	35,000	1,200	0.02	0.04	50,000	650	0.025	0.075	35,000	650	0.015	0.045
2004-010		1	35,000	1,200	0.03	0.09	35,000	1,200	0.02	0.04	50,000	650	0.025	0.075	35,000	650	0.015	0.045	
2004-0125		1.25	35,000	1,050	0.025	0.075	35,000	1,050	0.018	0.036	50,000	600	0.022	0.067	35,000	575	0.013	0.04	
2004-015		1.5	35,000	900	0.02	0.06	35,000	900	0.016	0.033	50,000	550	0.02	0.06	35,000	500	0.012	0.036	
2004-0175		1.75	35,000	750	0.017	0.052	35,000	750	0.013	0.033	50,000	525	0.017	0.052	35,000	450	0.011	0.033	
2004-020		2	35,000	600	0.015	0.045	35,000	600	0.011	0.033	50,000	500	0.015	0.045	35,000	400	0.01	0.03	
2004-0225		2.25	35,000	525	0.013	0.04	35,000	525	0.01	0.031	48,000	475	0.013	0.04	35,000	380	0.01	0.027	
2004-025		2.5	35,000	450	0.012	0.036	35,000	450	0.01	0.03	46,000	450	0.012	0.036	35,000	360	0.01	0.025	
2004-030		3	35,000	400	0.01	0.03	35,000	400	0.008	0.024	42,000	400	0.01	0.03	35,000	330	0.007	0.021	
2004-035		3.5	35,000	350	0.007	0.02	35,000	350	0.006	0.018	38,000	350	0.007	0.021	35,000	300	0.007	0.018	
2004-040		4	35,000	300	0.005	0.015	35,000	300	0.005	0.015	35,000	300	0.005	0.015	35,000	250	0.005	0.015	
2004-045		4.5	32,000	230	0.004	0.012	32,000	230	0.004	0.012	32,000	230	0.004	0.012	32,000	200	0.004	0.01	
2004-050		5	30,000	160	0.003	0.01	30,000	160	0.003	0.01	30,000	160	0.003	0.01	30,000	150	0.003	0.008	
2004-060		6	23,000	90	0.003	0.005	23,000	90	0.003	0.005	23,000	90	0.003	0.005	23,000	80	0.003	0.004	

UDC Series

CBN Series

Square

Square

Radius

Radius

Radius

Radius

Ball / Long

Ball

Ball

Taper

Taper

Spiral

V Cutter

Drill

EURO Series

Technical Data

Milling Conditions for CSELB

WORK MATERIAL			COPPER / ALUMINUM ALLOYS				CARBON STEELS / ALLOY STEELS S45C / S50C / SK / SCM (~325HB)				PREHARDENED STEELS NAK80 / STAVAX / HPM38 (30~45HRC)				HARDENED STEELS STAVAX / HPM38 / SKD61 (45~55HRC)				
Model Number	Radius of Ball Nose (mm)	Effective Length (mm)	Spindle Speed (min ⁻¹)	Feed Rate (mm/min)	a _p Axial Depth (mm)	a _e Radial Depth (mm)	Spindle Speed (min ⁻¹)	Feed Rate (mm/min)	a _p Axial Depth (mm)	a _e Radial Depth (mm)	Spindle Speed (min ⁻¹)	Feed Rate (mm/min)	a _p Axial Depth (mm)	a _e Radial Depth (mm)	Spindle Speed (min ⁻¹)	Feed Rate (mm/min)	a _p Axial Depth (mm)	a _e Radial Depth (mm)	
2005-010	R0.25	1	34,000	1,300	0.035	0.105	34,000	1,300	0.03	0.06	45,000	900	0.03	0.09	32,000	900	0.02	0.06	
2005-0125		1.25	34,000	1,150	0.032	0.097	34,000	1,150	0.027	0.055	45,000	850	0.027	0.082	32,000	850	0.019	0.057	
2005-015		1.5	34,000	1,000	0.03	0.09	34,000	1,000	0.025	0.05	45,000	800	0.025	0.075	32,000	800	0.018	0.054	
2005-0175		1.75	34,000	900	0.027	0.082	34,000	900	0.024	0.048	45,000	750	0.023	0.07	32,000	750	0.017	0.051	
2005-020		2	34,000	800	0.025	0.075	34,000	800	0.023	0.046	45,000	700	0.022	0.066	32,000	700	0.016	0.048	
2005-0225		2.25	34,000	750	0.022	0.067	34,000	750	0.019	0.045	45,000	650	0.02	0.06	32,000	650	0.015	0.046	
2005-025		2.5	34,000	700	0.02	0.06	34,000	700	0.015	0.045	45,000	600	0.018	0.054	32,000	600	0.015	0.045	
2005-030		3	32,000	550	0.016	0.048	32,000	550	0.012	0.036	41,000	550	0.014	0.042	31,000	500	0.012	0.036	
2005-035		3.5	32,000	500	0.014	0.042	32,000	500	0.011	0.033	38,000	500	0.012	0.036	30,500	450	0.01	0.03	
2005-040		4	31,000	450	0.012	0.036	31,000	450	0.01	0.03	35,000	450	0.01	0.03	30,000	390	0.01	0.03	
2005-045		4.5	30,000	390	0.01	0.03	30,000	390	0.008	0.024	32,000	390	0.008	0.024	29,500	350	0.008	0.024	
2005-050		5	29,000	340	0.007	0.021	29,000	340	0.007	0.021	29,000	340	0.006	0.018	29,000	300	0.006	0.018	
2005-055		5.5	26,000	280	0.007	0.021	26,000	280	0.007	0.021	26,000	280	0.006	0.018	26,000	250	0.006	0.018	
2005-060		6	24,000	220	0.006	0.018	24,000	220	0.006	0.018	24,000	220	0.005	0.015	24,000	200	0.005	0.015	
2005-070		7	21,000	180	0.005	0.015	21,000	180	0.005	0.015	21,000	180	0.004	0.012	21,000	160	0.004	0.012	
2005-080		8	19,000	130	0.004	0.012	19,000	130	0.004	0.012	19,000	130	0.003	0.009	19,000	110	0.003	0.009	
2005-090		9	18,000	120	0.003	0.009	18,000	120	0.003	0.009	18,000	120	0.002	0.008	18,000	100	0.002	0.008	
2005-100		10	17,000	100	0.003	0.009	17,000	100	0.003	0.009	17,000	100	0.002	0.006	17,000	80	0.002	0.006	
2006-010		R0.3	1	33,000	1,500	0.05	0.15	33,000	1,500	0.04	0.08	40,000	1,300	0.045	0.09	30,000	1,300	0.04	0.06
2006-0125			1.25	33,000	1,500	0.05	0.15	33,000	1,500	0.04	0.08	40,000	1,300	0.045	0.09	30,000	1,300	0.04	0.06
2006-015	1.5		33,000	1,500	0.05	0.15	33,000	1,500	0.04	0.08	40,000	1,300	0.045	0.09	30,000	1,300	0.04	0.06	
2006-0175	1.75		33,000	1,450	0.047	0.142	33,000	1,450	0.038	0.076	40,000	1,250	0.045	0.09	30,000	1,250	0.038	0.057	
2006-020	2		33,000	1,400	0.045	0.135	33,000	1,400	0.036	0.072	40,000	1,200	0.045	0.09	30,000	1,200	0.036	0.054	
2006-0225	2.25		33,000	1,250	0.042	0.127	33,000	1,300	0.034	0.069	40,000	1,100	0.042	0.085	30,000	1,150	0.034	0.053	
2006-025	2.5		33,000	1,100	0.04	0.12	33,000	1,200	0.033	0.066	40,000	1,000	0.04	0.08	30,000	1,100	0.033	0.053	
2006-030	3		33,000	900	0.035	0.105	33,000	900	0.025	0.066	40,000	800	0.03	0.075	30,000	900	0.026	0.052	
2006-035	3.5		32,000	900	0.03	0.09	32,000	800	0.022	0.066	38,000	650	0.025	0.075	28,000	720	0.02	0.06	
2006-040	4		31,000	700	0.027	0.081	31,000	700	0.02	0.06	35,000	560	0.022	0.066	28,000	600	0.018	0.054	
2006-045	4.5		29,000	500	0.024	0.072	29,000	550	0.017	0.051	32,000	500	0.018	0.054	26,000	500	0.015	0.045	
2006-050	5		29,000	440	0.018	0.054	29,000	440	0.015	0.045	29,000	440	0.015	0.045	26,000	440	0.012	0.036	
2006-055	5.5		26,000	410	0.016	0.048	26,000	410	0.014	0.042	26,000	410	0.014	0.042	25,000	410	0.01	0.03	
2006-060	6		24,000	380	0.012	0.036	24,000	380	0.012	0.036	24,000	380	0.01	0.03	24,000	380	0.008	0.024	
2006-065	6.5		22,000	340	0.011	0.033	22,000	340	0.011	0.033	22,000	340	0.009	0.027	22,000	340	0.007	0.021	
2006-070	7		21,000	310	0.01	0.03	21,000	310	0.01	0.03	21,000	310	0.008	0.024	21,000	310	0.006	0.018	
2006-080	8		18,000	240	0.008	0.024	18,000	240	0.008	0.024	18,000	240	0.006	0.018	18,000	240	0.005	0.015	
2006-090	9		16,000	180	0.007	0.021	16,000	180	0.007	0.021	16,000	180	0.005	0.015	16,000	180	0.004	0.012	
2006-100	10		15,000	160	0.006	0.018	15,000	160	0.006	0.018	15,000	160	0.004	0.012	15,000	160	0.003	0.01	
2006-120	12		14,000	150	0.005	0.015	14,000	150	0.005	0.015	14,000	150	0.003	0.009	14,000	150	0.002	0.008	
2007-020	R0.35	2	32,000	1,800	0.07	0.21	32,000	1,600	0.05	0.1	38,000	1,600	0.06	0.12	28,000	1,600	0.05	0.075	
2007-040		4	32,000	1,000	0.05	0.15	32,000	900	0.03	0.09	34,000	800	0.04	0.12	28,000	800	0.03	0.06	
2007-060		6	26,000	550	0.022	0.066	26,000	550	0.018	0.054	26,000	500	0.018	0.054	23,000	500	0.014	0.042	
2007-080		8	19,000	340	0.012	0.036	19,000	340	0.012	0.036	19,000	320	0.01	0.03	19,000	320	0.008	0.024	

Milling Conditions for CSELB

WORK MATERIAL			COPPER / ALUMINUM ALLOYS				CARBON STEELS / ALLOY STEELS S45C / S50C / SK / SCM (~325HB)				PREHARDENED STEELS NAK80 / STAVAX / HPM38 (30~45HRC)				HARDENED STEELS STAVAX / HPM38 / SKD61 (45~55HRC)				
Model Number	Radius of Ball Nose (mm)	Effective Length (mm)	Spindle Speed (min ⁻¹)	Feed Rate (mm/min)	a _p Axial Depth (mm)	a _e Radial Depth (mm)	Spindle Speed (min ⁻¹)	Feed Rate (mm/min)	a _p Axial Depth (mm)	a _e Radial Depth (mm)	Spindle Speed (min ⁻¹)	Feed Rate (mm/min)	a _p Axial Depth (mm)	a _e Radial Depth (mm)	Spindle Speed (min ⁻¹)	Feed Rate (mm/min)	a _p Axial Depth (mm)	a _e Radial Depth (mm)	
2008-020	R0.4	2	30,000	2,200	0.1	0.3	30,000	1,800	0.06	0.12	35,000	1,800	0.07	0.14	25,000	1,700	0.07	0.1	
2008-030		3	30,000	1,700	0.08	0.24	30,000	1,600	0.05	0.1	35,000	1,600	0.06	0.12	25,000	1,500	0.06	0.09	
2008-040		4	30,000	1,400	0.07	0.21	30,000	1,300	0.04	0.1	35,000	1,300	0.05	0.12	25,000	1,200	0.045	0.09	
2008-050		5	30,000	1,100	0.06	0.18	30,000	1,100	0.035	0.1	30,000	1,100	0.04	0.12	25,000	1,000	0.04	0.08	
2008-060		6	27,000	900	0.04	0.12	27,000	900	0.025	0.075	27,000	800	0.03	0.09	23,000	800	0.023	0.069	
2008-070		7	24,000	700	0.025	0.075	24,000	700	0.022	0.066	24,000	600	0.02	0.06	21,000	600	0.015	0.045	
2008-080		8	19,000	450	0.02	0.06	19,000	450	0.02	0.06	19,000	450	0.015	0.045	19,000	450	0.01	0.03	
2008-090		9	18,000	400	0.016	0.048	18,000	400	0.016	0.048	18,000	360	0.013	0.039	18,000	360	0.009	0.027	
2008-100		10	15,000	350	0.012	0.036	15,000	350	0.012	0.036	15,000	300	0.01	0.03	15,000	300	0.007	0.021	
2008-120		12	14,000	300	0.01	0.03	14,000	300	0.01	0.03	14,000	240	0.006	0.018	14,000	240	0.006	0.018	
2008-160		16	13,500	240	0.006	0.018	13,500	240	0.006	0.018	13,500	190	0.003	0.01	13,500	190	0.003	0.01	
2009-020		R0.45	2	30,000	2,100	0.11	0.33	30,000	1,600	0.07	0.14	33,000	1,700	0.08	0.16	24,000	1,600	0.08	0.12
2009-040			4	30,000	1,600	0.08	0.24	30,000	1,500	0.055	0.12	33,000	1,400	0.06	0.14	24,000	1,300	0.05	0.1
2009-060			6	27,000	1,100	0.06	0.18	27,000	1,100	0.035	0.1	27,000	850	0.04	0.12	22,000	800	0.034	0.1
2009-080			8	22,000	710	0.03	0.09	22,000	700	0.023	0.069	22,000	560	0.021	0.063	18,500	550	0.017	0.051
2009-100			10	18,000	500	0.02	0.06	18,000	500	0.018	0.054	18,000	430	0.015	0.045	18,000	430	0.01	0.03
2009-120	12		16,000	420	0.015	0.045	16,000	420	0.015	0.045	16,000	350	0.009	0.027	16,000	350	0.007	0.021	
2009-140	14		14,000	380	0.012	0.042	14,000	380	0.012	0.042	14,000	280	0.006	0.018	14,000	280	0.006	0.018	
2009-160	16		13,500	360	0.01	0.04	13,500	360	0.01	0.04	13,500	200	0.004	0.016	13,500	200	0.004	0.016	
2009-180	18		13,000	340	0.006	0.024	13,000	340	0.006	0.024	13,000	120	0.003	0.012	13,000	120	0.003	0.012	
2010-020	R0.5		2	30,000	2,000	0.12	0.36	30,000	1,600	0.08	0.16	30,000	1,600	0.09	0.18	22,000	1,600	0.09	0.13
2010-025		2.5	30,000	2,000	0.12	0.36	30,000	1,600	0.08	0.16	30,000	1,600	0.09	0.18	22,000	1,600	0.09	0.13	
2010-030		3	30,000	1,800	0.11	0.33	24,000	1,600	0.07	0.14	30,000	1,500	0.08	0.16	21,500	1,400	0.08	0.12	
2010-040		4	30,000	1,700	0.09	0.27	24,000	1,500	0.065	0.13	30,000	1,300	0.075	0.15	21,500	1,300	0.075	0.1	
2010-050		5	30,000	1,600	0.08	0.24	24,000	1,400	0.06	0.12	30,000	1,200	0.07	0.14	21,500	1,200	0.06	0.09	
2010-060		6	30,000	1,400	0.06	0.18	18,000	1,200	0.04	0.12	30,000	1,100	0.06	0.12	21,500	1,100	0.05	0.1	
2010-070		7	27,000	1,200	0.05	0.15	17,000	1,000	0.03	0.09	24,000	800	0.04	0.12	20,000	900	0.03	0.09	
2010-080		8	24,000	1,000	0.04	0.12	16,500	900	0.027	0.081	18,500	620	0.035	0.1	18,500	580	0.025	0.1	
2010-090		9	22,000	720	0.035	0.11	15,500	700	0.02	0.08	16,500	550	0.025	0.1	16,500	500	0.02	0.08	
2010-100		10	20,000	650	0.03	0.09	15,000	500	0.018	0.072	14,800	490	0.02	0.08	14,800	430	0.015	0.06	
2010-120		12	18,000	600	0.02	0.08	15,000	500	0.016	0.064	13,400	380	0.01	0.05	13,400	380	0.008	0.04	
2010-140		14	16,000	530	0.015	0.06	14,000	460	0.015	0.06	12,000	350	0.008	0.04	12,000	350	0.006	0.03	
2010-160		16	14,000	460	0.014	0.056	14,000	460	0.014	0.056	10,500	250	0.005	0.025	10,500	250	0.005	0.025	
2010-180		18	13,500	440	0.012	0.06	13,500	440	0.012	0.06	9,500	200	0.004	0.02	9,500	200	0.004	0.02	
2010-200	20	13,000	430	0.008	0.04	13,000	430	0.008	0.04	9,000	150	0.003	0.015	9,000	150	0.003	0.015		
2010-220	22	12,000	380	0.007	0.035	12,000	380	0.007	0.035	8,500	120	0.002	0.01	8,500	120	0.002	0.01		
2012-025	R0.6	2.5	30,000	2,000	0.13	0.39	30,000	1,600	0.09	0.18	30,000	1,600	0.1	0.2	18,000	1,600	0.1	0.15	
2012-040		4	30,000	1,800	0.12	0.36	20,000	1,500	0.08	0.16	30,000	1,400	0.09	0.18	18,000	1,400	0.09	0.13	
2012-060		6	30,000	1,600	0.09	0.27	20,000	1,200	0.07	0.14	30,000	1,100	0.08	0.16	18,000	1,100	0.08	0.12	
2012-080		8	25,000	1,200	0.06	0.18	15,000	900	0.05	0.12	20,000	800	0.06	0.15	16,500	750	0.05	0.11	
2012-100		10	20,000	900	0.05	0.15	13,500	650	0.035	0.11	16,000	640	0.045	0.12	15,500	550	0.03	0.09	
2012-120		12	16,500	600	0.035	0.12	12,500	480	0.025	0.1	12,000	440	0.03	0.12	12,500	430	0.018	0.072	
2012-140		14	14,500	520	0.025	0.1	12,500	480	0.022	0.088	11,000	400	0.015	0.06	11,500	370	0.014	0.056	
2012-160		16	13,000	470	0.018	0.072	11,500	440	0.018	0.072	10,000	350	0.01	0.05	10,000	350	0.01	0.05	
2012-180		18	12,000	460	0.014	0.07	11,250	440	0.014	0.07	9,500	260	0.008	0.04	9,500	260	0.007	0.035	
2012-200		20	11,000	440	0.013	0.065	11,000	440	0.013	0.065	9,000	220	0.006	0.03	9,000	220	0.005	0.025	

UDC Series

CBN Series

Square

Square
Long Neck Square

Radius

Radius
Long Neck Radius

Taper Neck Radius

Ball / Long Shank Ball

Ball
Long Neck Ball

Taper Neck Ball

Taper
Taper

Spiral V Cutter

Drill

EURO Series

Technical Data

Milling Conditions for CSELB

WORK MATERIAL			COPPER / ALUMINUM ALLOYS				CARBON STEELS / ALLOY STEELS S45C / S50C / SK / SCM (~325HB)				PREHARDENED STEELS NAK80 / STAVAX / HPM38 (30~45HRC)				HARDENED STEELS STAVAX / HPM38 / SKD61 (45~55HRC)				
Model Number	Radius of Ball Nose (mm)	Effective Length (mm)	Spindle Speed (min ⁻¹)	Feed Rate (mm/min)	a _p Axial Depth (mm)	a _e Radial Depth (mm)	Spindle Speed (min ⁻¹)	Feed Rate (mm/min)	a _p Axial Depth (mm)	a _e Radial Depth (mm)	Spindle Speed (min ⁻¹)	Feed Rate (mm/min)	a _p Axial Depth (mm)	a _e Radial Depth (mm)	Spindle Speed (min ⁻¹)	Feed Rate (mm/min)	a _p Axial Depth (mm)	a _e Radial Depth (mm)	
2014-060	R0.7	6	30,000	1,700	0.11	0.33	23,000	1,500	0.08	0.16	30,000	1,300	0.09	0.18	16,000	1,200	0.09	0.13	
2014-080		8	30,000	1,400	0.09	0.27	17,000	1,000	0.06	0.15	30,000	1,000	0.07	0.17	15,000	900	0.06	0.12	
2014-120		12	17,000	900	0.06	0.18	13,000	600	0.04	0.12	13,000	580	0.045	0.14	12,500	550	0.03	0.1	
2014-160		16	12,500	540	0.028	0.12	11,000	500	0.024	0.1	9,500	380	0.016	0.08	9,500	380	0.015	0.06	
2015-030	R0.75	3	30,000	2,000	0.15	0.45	30,000	1,600	0.12	0.24	30,000	1,700	0.12	0.24	18,000	1,500	0.12	0.18	
2015-040		4	30,000	1,800	0.14	0.42	30,000	1,500	0.11	0.22	30,000	1,600	0.11	0.22	18,000	1,400	0.11	0.17	
2015-060		6	30,000	1,800	0.12	0.36	23,000	1,300	0.1	0.2	30,000	1,400	0.1	0.2	15,000	1,200	0.1	0.16	
2015-080		8	30,000	1,600	0.11	0.33	18,000	1,100	0.08	0.16	30,000	1,200	0.08	0.2	14,000	1,000	0.08	0.16	
2015-100		10	23,000	1,200	0.09	0.27	15,000	850	0.06	0.15	23,500	900	0.06	0.18	14,000	700	0.05	0.15	
2015-120		12	16,000	900	0.07	0.21	13,000	600	0.05	0.15	13,000	650	0.05	0.15	13,000	550	0.03	0.12	
2015-140		14	14,500	700	0.05	0.19	10,500	550	0.04	0.12	10,500	500	0.04	0.12	10,500	470	0.025	0.1	
2015-160		16	13,000	650	0.04	0.16	10,000	550	0.03	0.12	8,850	400	0.03	0.12	8,850	390	0.02	0.08	
2015-180		18	12,000	580	0.03	0.15	10,000	510	0.025	0.1	8,500	350	0.018	0.09	8,500	360	0.014	0.07	
2015-200		20	10,500	530	0.02	0.1	9,200	470	0.02	0.1	8,000	320	0.012	0.06	8,000	320	0.012	0.06	
2015-220		22	10,000	500	0.015	0.075	9,000	460	0.015	0.075	7,500	270	0.01	0.05	7,500	270	0.008	0.04	
2015-250		25	9,000	440	0.014	0.07	8,750	440	0.014	0.07	7,250	250	0.008	0.04	7,250	250	0.006	0.03	
2015-300		30	8,500	420	0.012	0.06	8,500	420	0.012	0.06	7,000	130	0.006	0.03	7,000	130	0.004	0.02	
2016-040		R0.8	4	30,000	2,000	0.16	0.48	30,000	1,600	0.12	0.24	30,000	1,800	0.12	0.36	18,000	1,400	0.1	0.2
2016-080			8	30,000	1,700	0.15	0.45	15,000	1,100	0.1	0.2	30,000	1,500	0.12	0.24	13,500	1,000	0.08	0.24
2016-120			12	23,000	1,200	0.1	0.3	11,000	700	0.06	0.18	18,000	1,000	0.06	0.18	12,500	650	0.04	0.16
2016-160	16		15,000	800	0.05	0.2	10,000	530	0.034	0.13	10,000	530	0.035	0.14	9,000	420	0.02	0.1	
2016-200	20		11,000	580	0.034	0.17	9,400	490	0.025	0.12	8,500	400	0.018	0.09	7,800	380	0.014	0.07	
2018-040	4		30,000	2,000	0.18	0.54	30,000	1,800	0.16	0.32	30,000	1,900	0.16	0.48	16,000	1,300	0.14	0.28	
2018-060	6	30,000	1,800	0.18	0.52	24,000	1,500	0.15	0.29	30,000	1,700	0.16	0.4	14,000	1,200	0.13	0.27		
2018-080	8	30,000	1,800	0.17	0.5	18,000	1,200	0.13	0.26	30,000	1,700	0.16	0.32	12,000	1,000	0.11	0.26		
2018-100	10	30,000	1,800	0.16	0.48	15,000	1,100	0.11	0.23	24,000	1,400	0.12	0.28	12,000	900	0.09	0.23		
2018-120	12	24,000	1,450	0.12	0.36	13,000	1,000	0.08	0.2	18,000	1,100	0.09	0.23	12,000	750	0.07	0.21		
2018-160	R0.9	16	15,000	900	0.07	0.3	12,000	750	0.05	0.18	15,000	750	0.04	0.14	9,500	480	0.025	0.11	
2018-180		18	13,000	800	0.06	0.24	11,000	650	0.04	0.16	11,000	600	0.035	0.14	8,800	440	0.02	0.1	
2018-200		20	11,500	650	0.05	0.2	9,500	600	0.03	0.15	8,500	450	0.025	0.11	8,300	420	0.018	0.08	
2018-220		22	10,000	590	0.035	0.18	8,500	550	0.03	0.14	8,000	400	0.02	0.1	7,800	400	0.015	0.075	
2018-250		25	8,000	500	0.035	0.17	8,000	480	0.025	0.12	7,000	350	0.018	0.09	7,000	350	0.012	0.06	
2018-300		30	7,500	450	0.025	0.13	7,500	420	0.02	0.08	6,500	280	0.014	0.07	6,500	280	0.008	0.04	

UDC Series

CBN Series

Square

Long Neck Square

Radius

Long Neck Radius

Taper Neck Radius

Ball / Long Shark Ball

Long Neck Ball

Taper Neck Ball

Taper

Spiral V Cutter

Drill

EURO Series

Technical Data

Milling Conditions for CSELB

WORK MATERIAL		COPPER / ALUMINUM ALLOYS					CARBON STEELS / ALLOY STEELS S45C / S50C / SK / SCM (~325HB)					PREHARDENED STEELS NAK80 / STAVAX / HPM38 (30~45HRC)				HARDENED STEELS STAVAX / HPM38 / SKD61 (45~55HRC)			
Model Number	Radius of Ball Nose (mm)	Effective Length (mm)	Spindle Speed (min ⁻¹)	Feed Rate (mm/min)	a _p Axial Depth (mm)	a _e Radial Depth (mm)	Spindle Speed (min ⁻¹)	Feed Rate (mm/min)	a _p Axial Depth (mm)	a _e Radial Depth (mm)	Spindle Speed (min ⁻¹)	Feed Rate (mm/min)	a _p Axial Depth (mm)	a _e Radial Depth (mm)	Spindle Speed (min ⁻¹)	Feed Rate (mm/min)	a _p Axial Depth (mm)	a _e Radial Depth (mm)	
2020-030	R1	3	30,000	2,000	0.2	0.6	30,000	2,000	0.21	0.42	30,000	2,000	0.2	0.6	16,000	1,300	0.17	0.5	
2020-040		4	30,000	2,000	0.2	0.6	30,000	2,000	0.21	0.42	30,000	2,000	0.2	0.6	16,000	1,300	0.17	0.5	
2020-060		6	30,000	2,000	0.2	0.6	30,000	2,000	0.21	0.42	30,000	2,000	0.2	0.6	14,000	1,100	0.15	0.4	
2020-080		8	30,000	2,000	0.2	0.6	30,000	2,000	0.18	0.36	30,000	2,000	0.16	0.56	12,000	950	0.12	0.4	
2020-100		10	30,000	2,000	0.2	0.6	30,000	2,000	0.14	0.42	30,000	2,000	0.13	0.45	10,800	850	0.1	0.4	
2020-120		12	30,000	2,000	0.18	0.54	30,000	2,000	0.12	0.36	30,000	2,000	0.1	0.35	10,800	850	0.08	0.32	
2020-130		13	26,000	1,700	0.17	0.52	26,000	1,700	0.11	0.34	25,000	1,600	0.09	0.3	10,800	850	0.07	0.28	
2020-140		14	22,000	1,450	0.15	0.5	22,000	1,450	0.11	0.33	20,000	1,300	0.08	0.24	10,800	850	0.06	0.24	
2020-160		16	15,000	1,000	0.1	0.4	15,000	1,000	0.07	0.28	10,800	700	0.06	0.18	10,800	600	0.03	0.15	
2020-180		18	13,500	900	0.08	0.32	13,500	900	0.06	0.24	9,700	600	0.05	0.15	9,700	520	0.025	0.12	
2020-200		20	12,000	800	0.07	0.28	12,000	800	0.05	0.2	8,650	500	0.04	0.16	8,650	450	0.02	0.1	
2020-220		22	10,500	700	0.05	0.25	10,500	700	0.04	0.2	8,200	470	0.03	0.12	8,200	440	0.018	0.09	
2020-250		25	9,000	600	0.04	0.2	9,000	600	0.035	0.17	7,800	440	0.025	0.1	7,800	440	0.016	0.08	
2020-270		27	8,000	530	0.037	0.18	8,000	530	0.032	0.16	7,400	390	0.022	0.09	7,400	390	0.013	0.06	
2020-300		30	7,000	470	0.035	0.17	7,000	470	0.03	0.15	7,000	350	0.02	0.08	7,000	350	0.01	0.05	
2020-320		32	6,750	450	0.032	0.16	6,750	450	0.027	0.13	6,550	300	0.017	0.07	6,550	300	0.009	0.04	
2020-350		35	6,500	430	0.03	0.15	6,500	430	0.025	0.12	6,150	250	0.015	0.06	6,150	250	0.008	0.04	
2020-400		40	6,500	430	0.02	0.1	6,500	430	0.02	0.1	5,250	150	0.01	0.05	5,250	150	0.006	0.03	
2025-060		R1.25	6	27,000	2,300	0.28	0.75	27,000	2,300	0.25	0.5	27,000	2,300	0.25	0.75	13,000	1,100	0.21	0.63
2025-080			8	27,000	2,300	0.28	0.75	27,000	2,300	0.25	0.5	27,000	2,300	0.25	0.75	13,000	1,100	0.21	0.63
2025-100	10		25,000	2,100	0.26	0.67	25,000	2,100	0.23	0.46	24,000	2,200	0.2	0.65	11,000	930	0.14	0.44	
2025-150	15		22,000	1,950	0.23	0.59	22,000	1,950	0.15	0.45	20,000	1,600	0.13	0.42	9,000	720	0.08	0.32	
2025-200	20		11,000	1,150	0.14	0.38	11,000	1,150	0.1	0.3	8,000	600	0.06	0.24	7,600	470	0.04	0.12	
2025-250	25		8,300	1,000	0.09	0.27	8,300	1,000	0.06	0.24	6,200	450	0.045	0.18	5,800	400	0.03	0.1	
2025-300	30		7,000	700	0.06	0.24	7,000	700	0.05	0.2	5,000	380	0.03	0.12	4,800	360	0.022	0.088	
2025-350	35		5,500	530	0.04	0.2	5,500	530	0.035	0.17	4,200	300	0.025	0.1	4,200	270	0.015	0.06	
2030-060	R1.5		6	24,000	2,500	0.32	0.9	24,000	2,500	0.32	0.9	24,000	2,500	0.3	0.9	14,000	1,400	0.25	0.76
2030-080			8	24,000	2,500	0.32	0.9	24,000	2,500	0.32	0.9	24,000	2,500	0.3	0.9	14,000	1,400	0.25	0.76
2030-100		10	22,000	2,300	0.28	0.8	22,000	2,300	0.28	0.8	24,000	2,500	0.25	0.75	13,000	1,200	0.25	0.76	
2030-120		12	22,000	2,300	0.28	0.7	22,000	2,300	0.28	0.7	20,000	2,100	0.2	0.65	10,700	1,000	0.18	0.54	
2030-140		14	20,000	2,100	0.24	0.6	20,000	2,100	0.24	0.6	18,000	1,850	0.18	0.5	9,400	800	0.16	0.48	
2030-150		15	20,000	2,100	0.24	0.6	20,000	2,100	0.24	0.6	17,000	1,750	0.17	0.5	9,200	750	0.14	0.42	
2030-160		16	20,000	2,100	0.24	0.6	20,000	2,100	0.24	0.6	16,000	1,650	0.16	0.5	9,000	700	0.14	0.42	
2030-180		18	17,000	1,950	0.22	0.5	17,000	1,950	0.22	0.5	13,500	1,300	0.14	0.43	8,000	650	0.12	0.36	
2030-200		20	14,000	1,800	0.2	0.45	14,000	1,800	0.2	0.45	11,000	1,000	0.12	0.36	7,000	600	0.1	0.3	
2030-220		22	11,000	1,500	0.18	0.38	11,000	1,500	0.18	0.38	8,700	750	0.1	0.3	6,300	490	0.08	0.24	
2030-250		25	8,000	1,250	0.16	0.32	8,000	1,250	0.16	0.32	6,400	510	0.08	0.24	5,600	390	0.06	0.18	
2030-270		27	7,000	1,100	0.13	0.31	7,000	1,100	0.13	0.31	5,500	480	0.06	0.22	4,700	380	0.05	0.15	
2030-300		30	6,000	1,000	0.1	0.3	6,000	1,000	0.1	0.3	4,600	450	0.05	0.2	3,900	370	0.04	0.12	
2030-320		32	5,700	900	0.085	0.29	5,700	900	0.085	0.29	3,900	380	0.045	0.18	3,400	320	0.035	0.11	
2030-350		35	5,500	800	0.07	0.28	5,500	800	0.07	0.28	3,300	320	0.04	0.16	2,900	270	0.03	0.1	
2030-400		40	4,500	700	0.05	0.25	4,500	700	0.05	0.25	2,700	240	0.03	0.12	2,300	210	0.02	0.08	

UDC Series

CBN Series

Square

Long Neck Square

Radius

Long Neck Radius

Taper Neck Radius

Ball / Long Shank Ball

Long Neck Ball

Taper Neck Ball

Taper

Spiral V Cutter

Drill

EURO Series

Technical Data

Milling Conditions for CSELB

WORK MATERIAL			COPPER / ALUMINUM ALLOYS				CARBON STEELS / ALLOY STEELS S45C / S50C / SK / SCM (~325HB)				PREHARDENED STEELS NAK80 / STAVAX / HPM38 (30~45HRC)				HARDENED STEELS STAVAX / HPM38 / SKD61 (45~55HRC)			
Model Number	Radius of Ball Nose (mm)	Effective Length (mm)	Spindle Speed (min ⁻¹)	Feed Rate (mm/min)	a _p Axial Depth (mm)	a _e Radial Depth (mm)	Spindle Speed (min ⁻¹)	Feed Rate (mm/min)	a _p Axial Depth (mm)	a _e Radial Depth (mm)	Spindle Speed (min ⁻¹)	Feed Rate (mm/min)	a _p Axial Depth (mm)	a _e Radial Depth (mm)	Spindle Speed (min ⁻¹)	Feed Rate (mm/min)	a _p Axial Depth (mm)	a _e Radial Depth (mm)
2035-100	R1.75	10	24,000	2,700	0.35	1	24,000	2,700	0.35	1	21,000	2,400	0.35	1	12,000	1,700	0.3	0.9
2035-150		15	20,000	2,200	0.29	0.8	20,000	2,200	0.29	0.8	17,000	2,000	0.25	0.7	9,100	1,000	0.19	0.57
2035-200		20	15,000	1,800	0.24	0.6	15,000	1,800	0.24	0.6	12,000	1,450	0.14	0.45	6,800	600	0.13	0.39
2035-250		25	10,000	1,600	0.2	0.47	10,000	1,600	0.2	0.47	8,500	950	0.12	0.34	6,000	540	0.09	0.27
2035-300		30	6,900	1,200	0.18	0.36	6,900	1,200	0.18	0.36	5,500	480	0.09	0.24	4,800	380	0.06	0.18
2035-400		40	4,500	780	0.07	0.3	4,500	780	0.07	0.3	3,000	310	0.04	0.18	2,800	260	0.035	0.11
2035-450		45	3,900	680	0.06	0.26	3,900	680	0.06	0.26	2,300	240	0.03	0.14	2,000	200	0.025	0.1
2040-080		8	24,000	2,900	0.4	1.2	24,000	2,900	0.4	1.2	18,000	2,400	0.4	1.2	11,000	2,000	0.34	1
2040-100	R2	10	24,000	2,900	0.4	1.2	24,000	2,900	0.4	1.2	18,000	2,400	0.4	1.2	11,000	2,000	0.34	1
2040-120		12	24,000	2,900	0.4	1.2	24,000	2,900	0.4	1.2	18,000	2,400	0.4	1.2	9,700	1,500	0.28	0.85
2040-140		14	21,000	2,630	0.35	1.1	21,000	2,630	0.35	1.1	15,000	2,150	0.3	1.1	9,700	1,200	0.28	0.8
2040-150		15	19,000	2,350	0.32	1	19,000	2,350	0.32	1	15,000	2,150	0.3	1	8,800	1,100	0.24	0.7
2040-160		16	18,000	2,250	0.3	1	18,000	2,250	0.3	1	15,000	2,150	0.3	0.9	8,000	1,000	0.2	0.6
2040-180		18	16,500	2,050	0.3	0.95	16,500	2,050	0.3	0.95	13,500	1,950	0.25	0.8	7,500	850	0.17	0.5
2040-200		20	15,000	1,900	0.3	0.9	15,000	1,900	0.3	0.9	12,000	1,750	0.2	0.7	7,000	750	0.15	0.45
2040-220		22	13,500	1,700	0.27	0.8	13,500	1,700	0.27	0.8	10,500	1,500	0.17	0.6	6,500	650	0.13	0.4
2040-250		25	12,000	1,550	0.25	0.7	12,000	1,550	0.25	0.7	9,000	1,300	0.15	0.5	6,000	560	0.12	0.36
2040-270		27	9,500	1,450	0.22	0.6	9,500	1,450	0.22	0.6	8,000	1,050	0.12	0.4	5,500	510	0.1	0.28
2040-300		30	7,000	1,400	0.2	0.5	7,000	1,400	0.2	0.5	7,000	850	0.1	0.3	5,000	460	0.08	0.2
2040-320		32	6,500	1,300	0.2	0.45	6,500	1,300	0.2	0.45	5,900	650	0.1	0.27	4,500	410	0.075	0.18
2040-350		35	6,000	1,200	0.2	0.4	6,000	1,200	0.2	0.4	4,800	450	0.1	0.25	4,000	370	0.07	0.17
2040-400		40	4,000	1,000	0.11	0.33	4,000	1,000	0.11	0.33	3,450	400	0.06	0.24	2,900	270	0.06	0.15
2040-450		45	3,800	760	0.08	0.32	3,800	760	0.08	0.32	2,700	300	0.05	0.2	2,300	240	0.04	0.12
2040-500		50	3,400	680	0.07	0.28	3,400	680	0.07	0.28	2,000	240	0.04	0.16	1,700	190	0.03	0.12
2040-600		60	3,000	600	0.05	0.2	3,000	600	0.05	0.2	1,800	220	0.03	0.12	1,600	170	0.02	0.08
2050-100		R2.5	10	18,000	3,000	0.5	1.5	18,000	3,000	0.5	1.5	13,750	2,400	0.45	1.4	8,800	1,800	0.42
2050-150	15		18,000	3,000	0.5	1.5	18,000	3,000	0.5	1.5	13,750	2,400	0.45	1.4	7,800	1,300	0.34	1
2050-200	20		14,000	2,600	0.37	1.2	15,600	2,600	0.37	1.2	12,000	1,800	0.36	1.1	6,300	830	0.27	0.75
2050-250	25		12,000	2,000	0.33	1.1	12,000	2,000	0.33	1.1	9,600	1,350	0.25	1	5,700	750	0.25	0.67
2050-300	30		9,600	1,800	0.31	0.9	9,600	1,800	0.31	0.9	8,400	1,100	0.23	0.8	5,000	650	0.2	0.5
2050-350	35		8,400	1,700	0.3	0.75	8,400	1,700	0.3	0.75	7,200	850	0.2	0.6	4,400	530	0.16	0.33
2050-400	40		5,500	1,500	0.25	0.5	4,800	1,500	0.25	0.5	3,800	440	0.13	0.35	3,300	390	0.09	0.22
2050-450	45		4,000	1,200	0.2	0.42	4,000	1,200	0.2	0.42	3,300	400	0.11	0.3	2,800	330	0.08	0.18
2050-500	50		3,200	1,000	0.16	0.37	3,200	1,000	0.16	0.37	2,750	350	0.08	0.27	2,350	270	0.07	0.15
2060-100	R3		10	16,000	3,100	0.6	1.8	16,000	3,100	0.6	1.8	11,000	2,310	0.55	1.7	7,500	1,800	0.5
2060-150		15	16,000	3,100	0.6	1.8	16,000	3,100	0.6	1.8	11,000	2,310	0.55	1.7	7,500	1,800	0.5	1.5
2060-180		18	16,000	3,100	0.6	1.8	16,000	3,100	0.6	1.8	11,000	2,310	0.55	1.7	7,000	1,500	0.45	1.45
2060-200		20	16,000	3,100	0.6	1.8	16,000	3,100	0.6	1.8	11,000	2,310	0.55	1.7	6,500	1,300	0.4	1.4
2060-220		22	14,500	2,850	0.52	1.6	14,500	2,850	0.52	1.6	10,500	2,050	0.47	1.5	5,900	1,050	0.36	1.1
2060-250		25	13,000	2,600	0.45	1.5	13,000	2,600	0.45	1.5	10,000	1,800	0.4	1.3	5,300	840	0.32	0.9
2060-270		27	11,500	2,350	0.42	1.4	11,500	2,350	0.42	1.4	9,000	1,550	0.35	1.2	5,000	790	0.31	0.85
2060-300		30	10,000	2,100	0.4	1.3	10,000	2,100	0.4	1.3	8,000	1,350	0.3	1.1	4,700	750	0.3	0.8
2060-320		32	9,000	1,950	0.39	1.2	9,000	1,950	0.39	1.2	7,500	1,200	0.28	1	4,400	710	0.27	0.7
2060-350		35	8,000	1,800	0.38	1.1	8,000	1,800	0.38	1.1	7,000	1,100	0.26	0.9	4,200	670	0.25	0.6
2060-400		40	7,000	1,800	0.36	0.9	7,000	1,800	0.36	0.9	6,000	900	0.23	0.75	3,700	550	0.2	0.4
2060-450		45	5,800	1,700	0.33	0.75	5,800	1,700	0.33	0.75	4,600	670	0.19	0.6	3,200	470	0.15	0.3
2060-500		50	4,000	1,500	0.3	0.6	4,000	1,500	0.3	0.6	3,200	450	0.15	0.4	2,800	400	0.1	0.2
2060-600		60	2,700	1,000	0.21	0.42	2,700	1,000	0.21	0.42	2,300	320	0.1	0.3	1,950	270	0.08	0.16

a_p : Axial Depth (mm)
 a_e : Radial Depth (mm)

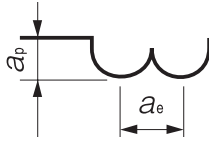

- Note:
- Decrease the feed rate more than 50% from the milling parameters when slot milling.
 - Decrease both spindle speed and feed rate proportionally when the milling parameters exceed the machines maximum speed, or when the tool is chattering and heats up to a red color.
 - Recommend oil coolant for Stainless Steels and Heat Resistant Alloys.
 - Recommend wet coolant for Copper.

* Refer to page 579 for tool shape.

UDC Series

CBN Series

Square

Long Neck Square

Radius

Long Neck Radius

Taper Neck Radius

Ball

Ball / Long Shank Ball

Long Neck Ball

Taper Neck Ball

Taper

Taper

Spiral V Cutter

Drill

EURO Series

Technical Data



Size R0.2~R3

DCLB



Material Applications (☆ Highly Recommended ● Recommended ○ Suggested)

Work Material															
Carbon Steels S45C S55C	Alloy Steels SK / SCM SUS	Prehardened Steels NAK HPM	Hardened Steels			Cast Iron	Aluminum Alloys	Graphite	Copper	Plastics	Glass Filled Plastics	Titanium Alloys	Heat Resistant Alloys	Cemented Carbide	Hard Brittle (Non-Metallic) Materials
			~55HRC	~60HRC	~70HRC										
							○	☆	○	○	●				○

Features

Diamond coated 2 flute long neck ball end mills for Graphite Electrodes.

A highly adhesive coating base, offers long tool life and excellent wear resistance.

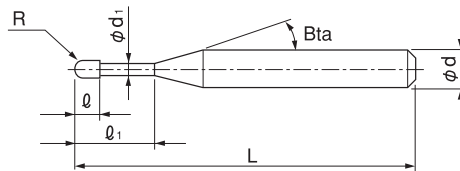

The shank taper angle shown is not an exact value and to avoid contact with the work piece, we recommend the user controls the precise value of this angle. Shank taper angle should not make contact with the work piece.

Neck diameter / effective length by inclined angles have been changed.
Change date: From production in December, 2012.

Total 68 models

Unit (mm)

Model Number	Radius of Ball Nose R	Effective Length l_1	Length of Cut l	Neck Diameter ϕd_1	Shank Taper Angle Bta	Overall Length L	Shank Diameter ϕd	Price ¥	Effective Length by Inclined Angles				
									30°	1°	1° 30'	2°	3°
DCLB 2004-0020	R0.2	2	0.32	0.37	16°	45	4	13,000	2.24	2.41	2.54	2.65	2.85
DCLB 2004-0030		3							3.33	3.52	3.67	3.80	4.08
DCLB 2004-0040		4							4.39	4.61	4.78	4.94	5.30
DCLB 2004-0050	R0.25	5	0.4	0.47	16°	45	4	13,000	5.45	5.69	5.88	6.08	6.52
DCLB 2005-0020		2							2.29	2.49	2.64	2.78	3.01
DCLB 2005-0030		3							3.39	3.61	3.79	3.95	4.24
DCLB 2005-0060	R0.3	6	0.48	0.57	16°	45	4	13,000	6.59	6.89	7.13	7.37	7.91
DCLB 2005-0100		10							10.78	11.16	11.53	11.93	12.80
DCLB 2006-0020		2							2.33	2.55	2.73	2.89	3.16
DCLB 2006-0030	R0.3	3	0.48	0.57	16°	45	4	13,000	3.44	3.70	3.90	4.08	4.40
DCLB 2006-0040		4							4.53	4.82	5.05	5.24	5.62
DCLB 2006-0060		6							6.67	7.01	7.28	7.52	8.07
DCLB 2006-0100	R0.4	10	0.64	0.77	16°	45	4	13,000	10.89	11.31	11.68	12.08	12.96
DCLB 2006-0120		12							12.98	13.44	13.88	14.36	15.41
DCLB 2008-0100		10							10.88	11.30	11.67	12.07	12.94
DCLB 2008-0120	R0.4	12	0.64	0.77	16°	45	4	13,000	12.97	13.43	13.87	14.34	15.39
DCLB 2008-0160		16							17.13	17.69	18.27	18.90	20.28

Model Number	Radius of Ball Nose R	Effective Length l_1	Length of Cut l	Neck Diameter ϕd	Shank Taper Angle Bta	Overall Length L	Shank Diameter ϕd	Price ¥	Effective Length by Inclined Angles					
									30°	1°	1° 30'	2°	3°	
DCLB 2010-0030	RO.5	3	0.8	0.96	16°	45	4	13,000	3.45	3.69	3.89	4.06	4.37	
DCLB 2010-0050		5				45	4	13,000	5.61	5.91	6.16	6.37	6.81	
DCLB 2010-0060		6				45	4	13,000	6.67	7.01	7.27	7.51	8.04	
DCLB 2010-0080		8				45	4	13,000	8.79	9.17	9.47	9.78	10.48	
DCLB 2010-0100		10	1.5			60	4	13,000	10.89	11.31	11.67	12.06	12.93	
DCLB 2010-0100-08		10	0.8			45	4	13,000	10.89	11.31	11.67	12.06	12.93	
DCLB 2010-0120		12				50	4	13,000	12.98	13.44	13.87	14.34	15.38	
DCLB 2010-0160		16				50	4	13,000	17.14	17.70	18.27	18.89	20.27	
DCLB 2010-0200	20	1.5		60	4	13,000	21.28	21.95	22.68	23.45	25.17			
DCLB 2015-0060	RO.75	6	1.2	1.44	16°	45	4	15,000	6.14	6.32	6.51	6.71	7.16	
DCLB 2015-0100		10				45	4	15,000	10.27	10.58	10.91	11.27	12.06	
DCLB 2015-0160		16				50	4	15,000	16.46	16.97	17.51	18.10	19.40	
DCLB 2020-0040	R1	4	1.6	1.9	16°	45	4	13,000	4.13	4.23	4.34	4.46	4.73	
DCLB 2020-0060		6				45	4	13,000	6.19	6.36	6.54	6.74	7.17	
DCLB 2020-0080		8				45	4	13,000	8.25	8.49	8.74	9.02	9.62	
DCLB 2020-0100		10				45	4	13,000	10.31	10.62	10.94	11.29	12.07	
DCLB 2020-0120		12				45	4	13,000	12.38	12.75	13.15	13.57	14.52	
DCLB 2020-0160		16				50	4	13,000	16.50	17.01	17.55	18.12	19.41	
DCLB 2020-0200-16		20				3	60	4	13,000	20.63	21.27	21.95	22.68	No Interference
DCLB 2020-0200		20					70	4	13,000	20.63	21.27	21.95	22.68	No Interference
DCLB 2020-0250		25	1.6	65	4	13,000	25.79	26.59	27.45	28.37	No Interference			
DCLB 2020-0250-30		25	3	65	4	13,000	25.79	26.59	27.45	28.37	No Interference			
DCLB 2020-0300-16		30	1.6	70	4	13,000	30.94	31.92	32.95	No Interference	No Interference			
DCLB 2020-0300		30	3	70	4	13,000	30.94	31.92	32.95	No Interference	No Interference			
DCLB 2020-0350		35		1.91	70	4	13,000	36.09	37.23	38.45	No Interference	No Interference		
DCLB 2020-0400		40	1.6	80	4	13,500	41.25	42.55	No Interference	No Interference	No Interference			
DCLB 2030-0160		R1.5	16	2.4	2.9	16°	60	6	15,000	16.49	16.98	17.50	18.06	19.30
DCLB 2030-0200			20				60	6	15,000	20.61	21.23	21.90	22.61	24.20
DCLB 2030-0250	25		70				6	17,000	25.77	26.56	27.40	28.30	30.31	
DCLB 2030-0300	30		4.5				80	4	13,500	30.93	No Interference	No Interference	No Interference	No Interference
DCLB 2030-0300-S6	30		2.4				80	6	17,000	30.93	31.88	32.90	34.00	No Interference
DCLB 2030-0400-S6	40						80	6	18,500	41.24	42.53	43.91	No Interference	No Interference
DCLB 2030-0400	40		4.5				80	4	15,000	41.24	No Interference	No Interference	No Interference	No Interference
DCLB 2040-0160	R2	16	3.2	3.9	16°	70	6	16,500	16.47	16.94	17.45	17.99	19.19	
DCLB 2040-0200		20				70	6	16,500	20.60	21.20	21.85	22.54	No Interference	
DCLB 2040-0250		25				70	6	16,500	25.75	26.53	27.35	28.24	No Interference	
DCLB 2040-0300		30				70	6	16,500	30.91	31.85	32.85	No Interference	No Interference	
DCLB 2040-0300-60		30				6	100	4	18,500	No Interference	No Interference	No Interference	No Interference	No Interference
DCLB 2040-0400-S6		40	3.2	16°	90	6	18,500	41.22	42.50	No Interference	No Interference	No Interference		
DCLB 2040-0400		40	6	—	100	4	18,500	No Interference	No Interference	No Interference	No Interference	No Interference		
DCLB 2040-0500-S6		50	3.2	16°	100	6	19,800	51.54	53.15	No Interference	No Interference	No Interference		
DCLB 2040-0500		50	6	—	100	4	19,000	No Interference	No Interference	No Interference	No Interference	No Interference		
DCLB 2040-0600		60		3.91	—	100	4	19,000	No Interference	No Interference	No Interference	No Interference	No Interference	
DCLB 2050-0200	R2.5	20	4	4.8	16°	70	6	16,500	20.76	21.36	21.99	No Interference	No Interference	
DCLB 2050-0300		30				80	6	17,000	31.08	32.00	No Interference	No Interference	No Interference	
DCLB 2060-0300	R3	30	4.8	5.7	—	80	6	17,000	No Interference	No Interference	No Interference	No Interference	No Interference	
DCLB 2060-0400		40				100	6	19,800	No Interference	No Interference	No Interference	No Interference	No Interference	
DCLB 2060-0500		50				120	6	19,800	No Interference	No Interference	No Interference	No Interference	No Interference	
DCLB 2060-0600		60		120		6	23,000	No Interference	No Interference	No Interference	No Interference	No Interference		
DCLB 2060-0700		70		5.71		—	120	6	23,000	No Interference	No Interference	No Interference	No Interference	No Interference
DCLB 2060-0800		80					120	6	25,300	No Interference	No Interference	No Interference	No Interference	No Interference

- UDC Series
- CBN Series
- Square
- Long Neck Square
- Radius
- Long Neck Radius
- Taper Neck Radius
- Ball / Long Shank Ball
- Long Neck Ball
- Taper Neck Ball
- Taper
- Spiral V Cutter
- Drill
- EURO Series
- Technical Data

Milling Conditions for DCLB

WORK MATERIAL			GRAPHITE			
Model Number	Radius of Ball Nose (mm)	Effective Length (mm)	Spindle Speed (min ⁻¹)	Feed Rate (mm/min)	a _p Axial Depth (mm)	a _e Radial Depth (mm)
2004-0020	R0.2	2	33,500	1,100	0.1	0.04
2004-0030		3	33,500	1,100	0.09	0.04
2004-0040		4	33,500	1,100	0.08	0.04
2004-0050		5	33,500	1,100	0.06	0.04
2005-0020	R0.25	2	33,500	1,200	0.11	0.05
2005-0030		3	33,500	1,200	0.1	0.05
2005-0060		6	33,500	1,200	0.07	0.05
2005-0100		10	33,500	1,200	0.03	0.05
2006-0020	R0.3	2	33,500	1,300	0.15	0.06
2006-0030		3	33,500	1,300	0.13	0.06
2006-0040		4	33,500	1,300	0.12	0.06
2006-0060		6	33,500	1,300	0.1	0.06
2006-0100		10	33,500	1,300	0.04	0.06
2006-0120		12	33,500	1,300	0.04	0.06
2008-0100	R0.4	10	33,500	1,400	0.13	0.08
2008-0120		12	33,500	1,400	0.1	0.08
2008-0160		16	33,500	1,400	0.08	0.08
2010-0030		3	33,500	1,500	0.2	0.1
2010-0050	R0.5	5	33,500	1,500	0.19	0.1
2010-0060		6	33,500	1,500	0.19	0.1
2010-0080		8	33,500	1,500	0.18	0.1
2010-0100(-08)		10	33,500	1,500	0.16	0.1
2010-0120		12	33,500	1,500	0.15	0.1
2010-0160		16	33,500	1,500	0.12	0.1
2010-0200		20	33,500	1,500	0.1	0.1
2015-0060		R0.75	6	30,000	1,500	0.35
2015-0100	10		30,000	1,500	0.3	0.15
2015-0160	16		30,000	1,500	0.25	0.15
2020-0040	R1	4	27,000	1,500	0.5	0.2
2020-0060		6	27,000	1,500	0.49	0.2
2020-0080		8	27,000	1,500	0.48	0.2
2020-0100		10	27,000	1,500	0.46	0.2
2020-0120		12	27,000	1,500	0.43	0.2
2020-0160		16	27,000	1,500	0.38	0.2
2020-0200(-16)		20	27,000	1,500	0.24	0.2
2020-0250(-30)		25	27,000	1,500	0.19	0.2
2020-0300(-16)		30	27,000	1,500	0.12	0.2
2020-0350		35	27,000	1,500	0.11	0.2
2020-0400		40	27,000	1,500	0.09	0.2

UDC Series

CBN Series

Square
Long Neck Square

Radius

Long Neck Radius
Taper Neck Radius

Ball / Long Shank Ball
Long Neck Ball
Taper Neck Ball

Taper

Spiral V Cutter

Drill

EURO Series

Technical Data

Milling Conditions for DCLB

WORK MATERIAL			GRAPHITE			
Model Number	Radius of Ball Nose (mm)	Effective Length (mm)	Spindle Speed (min ⁻¹)	Feed Rate (mm/min)	a_p Axial Depth (mm)	a_e Radial Depth (mm)
2030-0160	R1.5	16	18,000	1,650	0.5	0.45
2030-0200		20	18,000	1,650	0.44	0.45
2030-0250		25	18,000	1,650	0.36	0.45
2030-0300(-S6)		30	18,000	1,650	0.3	0.45
2030-0400(-S6)		40	18,000	1,650	0.2	0.45
2040-0160	R2	16	13,500	1,750	0.7	0.6
2040-0200		20	13,500	1,750	0.65	0.6
2040-0250		25	13,500	1,750	0.55	0.6
2040-0300		30	13,500	1,750	0.5	0.6
2040-0300(-60)		30	13,500	1,750	0.5	0.6
2040-0400(-S6)		40	13,500	1,750	0.4	0.6
2040-0500(-S6)		50	13,500	1,750	0.24	0.6
2040-0600	R2.5	60	13,500	1,750	0.18	0.6
2050-0200		20	10,800	1,600	0.8	0.75
2050-0300		30	10,800	1,600	0.6	0.75
2060-0300	R3	30	9,000	1,400	0.9	0.9
2060-0400		40	9,000	1,400	0.75	0.9
2060-0500		50	9,000	1,400	0.6	0.9
2060-0600		60	9,000	1,400	0.51	0.9
2060-0700		70	9,000	1,400	0.4	0.9
2060-0800		80	9,000	1,400	0.23	0.9

Note:

- Use a milling machine dedicated for Graphite.
- Decrease the feed rate more than 50% from the milling parameters when slot milling.
- Recommend air blow for Graphite.

Milling Amount (mm)
 a_p : Axial Depth (mm)
 a_e : Radial Depth (mm)

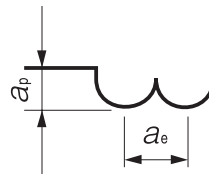

UDC Series

CBN Series

Square
Long Neck Square

Radius

Long Neck Radius

Taper Neck Radius

Ball

Ball / Long Shank Ball

Taper Neck Ball

Taper

Spiral V Cutter

Drill

EURO Series

Technical Data



Size R0.05~R3

DLCLB



NEW

Back taper geometry does not apply to R0.15 or below.

Material Applications (☆ Highly Recommended ● Recommended ○ Suggested)

Work Material															
Carbon Steels S45C S55C	Alloy Steels SK / SCM SUS	Prehardened Steels NAK HPM	Hardened Steels			Cast Iron	Aluminum Alloys	Graphite	Copper	Plastics	Glass Filled Plastics	Titanium Alloys	Heat Resistant Alloys	Cemented Carbide	Hard Brittle (Non-Metallic) Materials
			~55HRC	~60HRC	~70HRC										

Total 71 models

Model Number	Radius of Ball Nose R	Effective Length l_1	Length of Cut l	Neck Diameter ϕd_1	Shank Taper Angle Bta	Overall Length L	Shank Diameter ϕd	Price ¥	
DLCLB 2001-003	R0.05	0.3	0.08	0.095	11°	45	4	14,100	
DLCLB 2001-005		0.5							14,700
DLCLB 20015-003	R0.075	0.3	0.12	0.14	11°	45	4	15,600	
DLCLB 20015-005		0.5							16,500
DLCLB 20015-010		1							17,200
DLCLB 2002-003	R0.1	0.3	0.16	0.19	11°	45	4	11,300	
DLCLB 2002-005		0.5							11,300
DLCLB 2002-010		1							11,800
DLCLB 2002-015		1.5							12,300
DLCLB 2003-006	R0.15	0.6	0.24	0.29	11°	45	4	11,800	
DLCLB 2003-010		1							11,800
DLCLB 2003-015		1.5							12,300
DLCLB 2003-020		2							12,800
DLCLB 2004-010	R0.2	1	0.32	0.39	11°	45	4	10,300	
DLCLB 2004-020		2							10,500
DLCLB 2004-030		3							10,700
DLCLB 2004-040		4							10,900
DLCLB 2005-010	R0.25	1	0.4	0.49	11°	45	4	10,100	
DLCLB 2005-020		2							10,100
DLCLB 2005-030		3							10,300
DLCLB 2005-040		4							10,500
DLCLB 2005-050		5							10,700

2 Flutes DLC for Copper Electrode

Model Number	Radius of Ball Nose R	Effective Length ℓ_1	Length of Cut ℓ	Neck Diameter ϕd_1	Shank Taper Angle B α	Overall Length L	Shank Diameter ϕd	Price ¥
DLCLB 2006-010	R0.3	1	0.48	0.59	11°	45	4	7,900
DLCLB 2006-020		2				45		7,900
DLCLB 2006-030		3				45		8,100
DLCLB 2006-040		4				45		8,300
DLCLB 2006-050		5				45		8,500
DLCLB 2006-060		6				45		8,700
DLCLB 2008-020	R0.4	2	0.64	0.79	11°	45	4	8,100
DLCLB 2008-030		3				45		8,100
DLCLB 2008-040		4				45		8,300
DLCLB 2008-060		6				45		8,500
DLCLB 2008-080		8				45		8,700
DLCLB 2010-020	R0.5	2	0.8	0.98	11°	45	4	7,700
DLCLB 2010-030		3				45		7,700
DLCLB 2010-040		4				45		7,700
DLCLB 2010-050		5				45		7,900
DLCLB 2010-060		6				45		7,900
DLCLB 2010-080		8				45		8,300
DLCLB 2010-100		10				45		8,300
DLCLB 2010-120		12				45		8,300
DLCLB 2015-040	R0.75	4	1.2	1.47	11°	45	4	7,900
DLCLB 2015-060		6				45		7,900
DLCLB 2015-120		12				50		8,900
DLCLB 2015-180		18				55		9,900
DLCLB 2020-040	R1	4	1.6	1.98	11°	45	4	8,100
DLCLB 2020-060		6				45		8,100
DLCLB 2020-080		8				45		8,300
DLCLB 2020-100		10				45		8,300
DLCLB 2020-120		12				50		8,300
DLCLB 2020-140		14				50		8,300
DLCLB 2020-160		16				50		8,300
DLCLB 2020-200		20				55		9,200
DLCLB 2020-250		25				65		10,200

UDC Series

CBN Series

Square

Long Neck Square

Radius

Long Neck Radius

Taper Neck Radius

Ball / Long Shank Ball

Long Neck Ball

Taper Neck Ball

Taper

Spiral V Cutter

Drill

EURO Series

Technical Data

Model Number	Radius of Ball Nose R	Effective Length l_1	Effective Length by Inclined Angles				
			30°	1°	1° 30'	2°	3°
DLCLB 2006-010	RO.3	1	1.14	1.18	1.23	1.28	1.41
DLCLB 2006-020		2	2.18	2.28	2.38	2.50	2.78
DLCLB 2006-030		3	3.23	3.38	3.54	3.72	4.15
DLCLB 2006-040		4	4.28	4.48	4.70	4.94	5.52
DLCLB 2006-050		5	5.32	5.57	5.85	6.16	6.89
DLCLB 2006-060		6	6.37	6.67	7.01	7.38	8.26
DLCLB 2008-020	RO.4	2	2.18	2.27	2.37	2.48	2.75
DLCLB 2008-030		3	3.22	3.37	3.52	3.70	4.12
DLCLB 2008-040		4	4.27	4.47	4.68	4.92	5.48
DLCLB 2008-060		6	6.37	6.66	6.99	7.36	8.22
DLCLB 2008-080		8	8.46	8.86	9.30	9.79	10.96
DLCLB 2010-020	RO.5	2	2.19	2.28	2.37	2.48	2.73
DLCLB 2010-030		3	3.24	3.37	3.53	3.70	4.10
DLCLB 2010-040		4	4.28	4.47	4.68	4.92	5.47
DLCLB 2010-050		5	5.33	5.57	5.84	6.14	6.84
DLCLB 2010-060		6	6.38	6.67	6.99	7.35	8.21
DLCLB 2010-080		8	8.47	8.87	9.31	9.79	10.95
DLCLB 2010-100		10	10.57	11.07	11.62	12.23	13.68
DLCLB 2010-120	12	12.66	13.26	13.93	14.67	16.42	
DLCLB 2015-040	RO.75	4	4.21	4.39	4.58	4.80	5.31
DLCLB 2015-060		6	6.31	6.59	6.89	7.23	8.04
DLCLB 2015-120		12	12.59	13.18	13.83	14.55	16.26
DLCLB 2015-180		18	18.87	19.77	20.76	21.86	24.47
DLCLB 2020-040	R1	4	4.18	4.34	4.51	4.71	5.18
DLCLB 2020-060		6	6.27	6.53	6.82	7.15	7.92
DLCLB 2020-080		8	8.36	8.73	9.14	9.59	10.66
DLCLB 2020-100		10	10.46	10.93	11.45	12.02	13.39
DLCLB 2020-120		12	12.55	13.12	13.76	14.46	16.13
DLCLB 2020-140		14	14.65	15.32	16.07	16.90	18.87
DLCLB 2020-160		16	16.74	17.52	18.38	19.34	No Interference
DLCLB 2020-200		20	20.93	21.91	23.00	24.21	No Interference
DLCLB 2020-250		25	26.16	27.41	28.78	No Interference	No Interference

UDC Series

CBN Series

Square
Long Neck Square

Radius

Long Neck Radius
Taper Neck RadiusBall / Long Shank Ball
Long Neck Ball
Taper Neck Ball

Taper

Spiral V Cutter

Drill

EURO Series

Technical Data

2 Flutes DLC for Copper Electrode

Model Number	Radius of Ball Nose R	Effective Length ℓ_1	Length of Cut ℓ	Neck Diameter ϕd_1	Shank Taper Angle B α	Overall Length L	Shank Diameter ϕd	Price ¥
DLCLB 2030-100	R1.5	10	2.4	2.95	11°	60	6	10,500
DLCLB 2030-120		12				60	6	10,800
DLCLB 2030-140		14				60	6	10,800
DLCLB 2030-160		16				60	6	11,200
DLCLB 2030-200		20				70	6	11,200
DLCLB 2030-250		25				70	6	11,200
DLCLB 2030-300		30				70	6	12,200
DLCLB 2040-100	R2	10	3.2	3.95	11°	70	6	9,700
DLCLB 2040-150		15				70	6	9,700
DLCLB 2040-200		20				70	6	11,500
DLCLB 2040-250		25				70	6	12,200
DLCLB 2040-300		30				70	6	12,700
DLCLB 2040-400		40				80	6	13,700
DLCLB 2060-100		R3				10	4.8	5.95
DLCLB 2060-150	15		80	6	12,700			
DLCLB 2060-200	20		80	6	12,700			
DLCLB 2060-300	30		80	6	13,300			

UDC Series

CBN Series

Square

Long Neck Square

Radius

Long Neck Radius

Taper Neck Radius

Ball / Long Shank Ball

Long Neck Ball

Taper Neck Ball

Taper

Spiral V Cutter

Drill

EURO Series

Technical Data

Model Number	Radius of Ball Nose R	Effective Length l_1	Effective Length by Inclined Angles				
			30'	1°	1° 30'	2°	3°
DLCLB 2030-100	R1.5	10	10.51	10.96	11.46	12.01	13.32
DLCLB 2030-120		12	12.61	13.16	13.77	14.45	16.06
DLCLB 2030-140		14	14.70	15.36	16.08	16.89	18.80
DLCLB 2030-160		16	16.80	17.56	18.39	19.32	21.54
DLCLB 2030-200		20	20.98	21.95	23.02	24.20	27.01
DLCLB 2030-250		25	26.22	27.44	28.79	30.30	No Interference
DLCLB 2030-300		30	31.45	32.94	34.57	36.39	No Interference
DLCLB 2040-100	R2	10	10.49	10.91	11.38	11.90	13.14
DLCLB 2040-150		15	15.73	16.41	17.16	18.00	19.99
DLCLB 2040-200		20	20.96	21.90	22.94	24.09	No Interference
DLCLB 2040-250		25	26.20	27.39	28.72	30.19	No Interference
DLCLB 2040-300		30	31.43	32.89	34.50	No Interference	No Interference
DLCLB 2040-400		40	41.90	43.87	No Interference	No Interference	No Interference
DLCLB 2060-100	R3	10	No Interference	No Interference	No Interference	No Interference	No Interference
DLCLB 2060-150		15	No Interference	No Interference	No Interference	No Interference	No Interference
DLCLB 2060-200		20	No Interference	No Interference	No Interference	No Interference	No Interference
DLCLB 2060-300		30	No Interference	No Interference	No Interference	No Interference	No Interference

UDC Series

CBN Series

Square

Long Neck Square

Radius

Long Neck Radius

Taper Neck Radius

Ball / Long Shank Ball

Long Neck Ball

Taper Neck Ball

Taper

Spiral V Cutter

Drill

EURO Series

Technical Data

Milling Conditions for DLCLB

WORK MATERIAL			COPPER				TUNGSTEN COPPER			
Model Number	Radius of Ball Nose (mm)	Effective Length (mm)	Spindle Speed (min ⁻¹)	Feed Rate (mm/min)	a _p Axial Depth (mm)	a _e Radial Depth (mm)	Spindle Speed (min ⁻¹)	Feed Rate (mm/min)	a _p Axial Depth (mm)	a _e Radial Depth (mm)
2001-003	R0.05	0.3	43,600	220	0.01	0.01	32,700	160	0.008	0.008
2001-005		0.5	43,600	160	0.007	0.007	32,700	110	0.005	0.005
20015-003		0.3	43,600	250	0.015	0.02	32,700	190	0.012	0.016
20015-005	R0.075	0.5	43,600	220	0.015	0.02	32,700	150	0.012	0.016
20015-010		1	43,600	160	0.007	0.01	32,700	120	0.006	0.008
2002-003	R0.1	0.3	43,600	550	0.025	0.05	32,700	380	0.02	0.04
2002-005		0.5	43,600	550	0.025	0.05	32,700	380	0.02	0.04
2002-010		1	43,600	440	0.02	0.04	32,700	270	0.015	0.03
2002-015		1.5	32,900	250	0.015	0.03	24,700	120	0.008	0.02
2003-006	R0.15	0.6	43,600	760	0.03	0.07	32,700	550	0.03	0.07
2003-010		1	43,600	760	0.03	0.07	32,700	550	0.03	0.07
2003-015		1.5	43,600	550	0.025	0.05	32,700	290	0.02	0.05
2003-020	R0.2	2	39,200	390	0.02	0.03	29,400	200	0.01	0.02
2004-010		1	43,600	1,090	0.05	0.1	32,700	760	0.04	0.08
2004-020		2	43,600	650	0.035	0.06	32,700	380	0.02	0.05
2004-030		3	35,000	470	0.02	0.04	29,200	230	0.01	0.03
2004-040	R0.25	4	27,300	270	0.008	0.015	19,600	110	0.005	0.01
2005-010		1	43,600	1,420	0.08	0.15	32,700	890	0.08	0.15
2005-020		2	43,600	870	0.08	0.15	32,700	550	0.08	0.15
2005-030		3	38,200	650	0.06	0.1	29,500	390	0.06	0.08
2005-040		4	32,700	440	0.04	0.08	24,000	220	0.025	0.05
2005-050	R0.3	5	27,300	330	0.02	0.04	19,600	160	0.01	0.02
2006-010		1	43,600	1,870	0.12	0.2	32,700	1,400	0.12	0.2
2006-020		2	43,600	1,750	0.12	0.2	32,700	1,310	0.12	0.2
2006-030		3	43,600	1,090	0.1	0.14	32,700	760	0.08	0.1
2006-040		4	32,700	760	0.07	0.1	27,300	440	0.04	0.06
2006-050		5	29,500	650	0.05	0.08	24,000	330	0.02	0.04
2006-060	R0.4	6	27,300	550	0.04	0.06	21,800	220	0.01	0.03
2008-020		2	43,600	2,820	0.15	0.3	32,700	1,980	0.15	0.3
2008-030		3	43,600	2,180	0.15	0.3	32,700	1,530	0.15	0.3
2008-040		4	38,200	1,750	0.12	0.2	29,500	1,090	0.1	0.16
2008-060		6	32,700	1,090	0.08	0.15	21,800	550	0.05	0.1
2008-080	R0.5	8	23,800	760	0.05	0.06	17,300	320	0.02	0.025
2010-020		2	39,100	2,740	0.25	0.4	30,000	2,050	0.25	0.4
2010-030		3	39,100	2,740	0.25	0.4	30,000	1,960	0.25	0.4
2010-040		4	39,100	2,350	0.2	0.4	29,500	1,560	0.2	0.4
2010-050	R0.5	5	38,200	2,180	0.16	0.3	29,500	1,530	0.12	0.25
2010-060		6	34,500	1,840	0.14	0.3	26,200	1,150	0.1	0.25
2010-080		8	27,300	1,090	0.12	0.2	19,600	550	0.06	0.1
2010-100		10	20,300	810	0.08	0.15	16,200	300	0.03	0.05
2010-120	12	13,100	490	0.06	0.1	9,800	160	0.015	0.04	

UDC Series

CBN Series

Square

Long Neck Square

Radius

Long Neck Radius

Taper Neck Radius

Ball / Long Shark Ball

Long Neck Ball

Taper Neck Ball

Taper

Spiral V Cutter

Drill

EURO Series

Technical Data

Milling Conditions for DLCLB

WORK MATERIAL			COPPER				TUNGSTEN COPPER				
Model Number	Radius of Ball Nose (mm)	Effective Length (mm)	Spindle Speed (min ⁻¹)	Feed Rate (mm/min)	a_p Axial Depth (mm)	a_e Radial Depth (mm)	Spindle Speed (min ⁻¹)	Feed Rate (mm/min)	a_p Axial Depth (mm)	a_e Radial Depth (mm)	
2015-040	R0.75	4	25,500	2,270	0.3	0.6	21,300	1,700	0.3	0.6	
2015-060		6	25,500	2,040	0.3	0.6	21,300	1,530	0.3	0.6	
2015-120		12	17,500	1,090	0.15	0.3	13,100	550	0.1	0.2	
2015-180		18	8,500	590	0.08	0.12	6,800	170	0.02	0.06	
2020-040	R1	4	18,700	2,490	0.45	0.8	14,000	1,500	0.45	0.8	
2020-060		6	18,700	2,080	0.45	0.8	14,000	1,250	0.45	0.8	
2020-080		8	18,700	1,800	0.4	0.8	13,500	1,200	0.4	0.8	
2020-100		10	18,700	1,700	0.3	0.6	13,500	1,190	0.25	0.5	
2020-120		12	16,800	1,470	0.3	0.6	12,600	950	0.25	0.5	
2020-140		14	15,000	1,250	0.28	0.5	11,200	750	0.18	0.4	
2020-160		16	13,100	1,090	0.25	0.5	9,800	550	0.12	0.25	
2020-200		20	10,000	800	0.15	0.3	8,000	350	0.06	0.1	
2020-250		25	6,700	500	0.08	0.15	5,000	170	0.03	0.05	
2030-100		R1.5	10	15,000	2,550	0.6	1.2	12,000	1,800	0.6	1.2
2030-120			12	15,000	2,550	0.6	1.2	11,800	1,740	0.6	1.2
2030-140			14	15,000	2,510	0.6	1.2	11,700	1,670	0.6	1.2
2030-160	16		14,200	2,140	0.6	1	10,700	1,600	0.5	1	
2030-200	20		12,700	1,910	0.5	0.8	9,500	1,110	0.4	0.6	
2030-250	25		10,100	1,520	0.4	0.6	8,400	760	0.2	0.3	
2030-300	30		8,700	1,310	0.2	0.4	6,500	550	0.08	0.15	
2040-100	R2	10	11,500	2,880	0.8	1.6	8,600	2,010	0.8	1.6	
2040-150		15	11,500	2,670	0.8	1.6	8,600	1,880	0.8	1.6	
2040-200		20	11,500	2,460	0.8	1.6	8,200	1,640	0.8	1.2	
2040-250		25	10,300	2,210	0.6	1.2	6,700	1,270	0.5	1	
2040-300		30	9,000	1,800	0.5	1	5,300	900	0.3	0.5	
2040-400		40	6,000	900	0.4	0.8	3,800	380	0.15	0.3	
2060-100	R3	10	10,000	4,190	1	2.2	7,500	3,150	1	2.2	
2060-150		15	10,000	4,190	1	2.2	7,500	2,800	1	2.2	
2060-200		20	10,000	3,000	1	2	7,500	2,000	0.7	1.5	
2060-300		30	10,000	3,000	0.8	1.6	7,000	1,800	0.4	0.8	

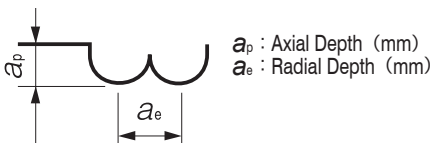

Note:

- Decrease the feed rate more than 50% from the milling parameters when slot milling.
- Decrease both spindle speed and feed rate proportionally when the milling parameters exceed the machine's maximum spindle speed, or when chattering occurs.
- Recommend wet coolant for Copper and Tungsten-Copper.

UDC Series

CBN Series

Square
Long Neck Square

Radius

Long Neck Radius
Taper Neck RadiusBall / Long Shank Ball
Long Neck Ball

Taper Neck Ball

Taper

Spiral V Cutter

Drill

EURO Series

Technical Data

Milling Example of Copper Electrode Model
DLCLB R1 × Effective Length 16

Tough Pitch Copper C1100

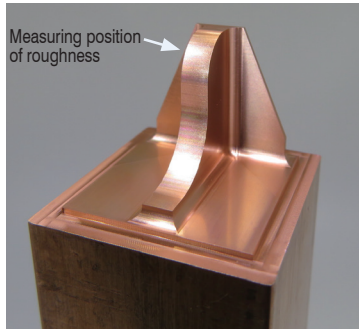

Model Size : 20 x 20 x Depth 16 mm
Coolant : Oil Mist

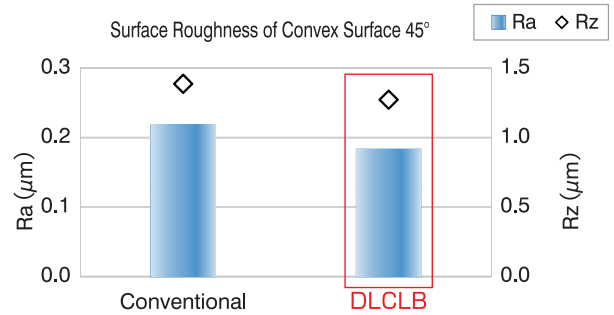

Improved surface roughness compared to the conventional model.

No	Milling Process	Milling Method	Tool	Spindle Speed (min ⁻¹)	Feed Rate (mm/min)	a_p Axial Depth (mm)	a_e Radial Depth (mm)	Overhang Length (mm)	Cycle Time
1	Roughing	Contour Milling	DLCLB 2020-160	10,800	1,090	0.25	0.5	24	1:31:59
2	Semi-finishing			10,800	1,090	0.05	0.05		1:31:15
3	Finishing			13,090	545	0.0001 (Cusp Height)	0.03		1:15:26
								Total	4:18:40

Conventional

DLCLB

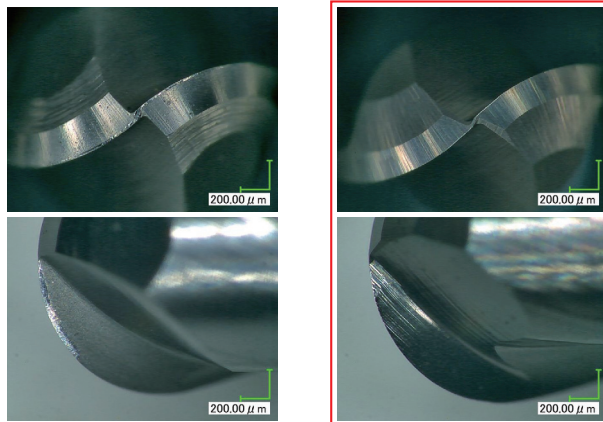

Tools after milling

DLCLB has less wear and damage after 4 hours of milling, and enables stable milling throughout the long cycle time.

- UDC Series
- CBN Series
- Square
- Long Neck Square
- Radius
- Long Neck Radius
- Taper Neck Radius
- Ball / Long Shank Ball
- Long Neck Ball
- Taper Neck Ball
- Taper
- Spiral V Cutter
- Drill
- EURO Series
- Technical Data

DLCLB series
Introduction Video



DLCLB series
Housing-rib
Electrode Milling Video



UDC Series

CBN Series

Square
Long Neck Square

Radius
Long Neck Radius
Taper Neck Radius

Ball / Long Shank Ball
Long Neck Ball
Taper Neck Ball

Taper
Taper

Spiral V Cutter

Drill

EURO Series

Technical Data



Size R0.2~R3

CPRB



Material Applications (☆ Highly Recommended ◎ Recommended ○ Suggested)

Work Material															
Carbon Steels S45C S55C	Alloy Steels SK / SCM SUS	Prehardened Steels NAK HPM	Hardened Steels			Cast Iron	Aluminum Alloys	Graphite	Copper	Plastics	Glass Filled Plastics	Titanium Alloys	Heat Resistant Alloys	Cemented Carbide	Hard Brittle (Non-Metallic) Materials
			~55HRC	~60HRC	~70HRC										
							○		◎	☆					

Features

Long neck ball design for milling Plastics.
Designed especially for deep rib milling using an undercut form.

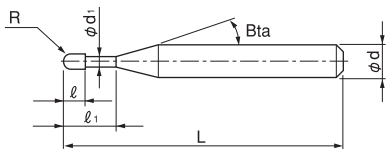

The shank taper angle shown is not an exact value and to avoid contact with the work piece, we recommend the user controls the precise value of this angle. Shank taper angle should not make contact with the work piece.

Total 80 models

Unit (mm)

Model Number	Radius of Ball Nose R	Effective Length l_1	Length of Cut l	Neck Diameter ϕd_1	Shank Taper Angle Bta	Overall Length L	Shank Diameter ϕd	Price ¥
CPRB 2004-1	R0.2	1	0.4	0.36	11°	45	4	8,000
CPRB 2004-2		2				45		8,800
CPRB 2004-3		3				45		9,800
CPRB 2005-2	R0.25	2	0.8	0.46	11°	45	4	8,000
CPRB 2005-4		4				45		8,000
CPRB 2005-6		6				45		8,800
CPRB 2005-8		8				45		8,800
CPRB 2005-10		10				50		9,500
CPRB 2006-2	R0.3	2	1	0.56	11°	45	4	7,200
CPRB 2006-4		4				45		7,200
CPRB 2006-6		6				45		7,200
CPRB 2006-8		8				45		7,200
CPRB 2008-2	R0.4	2	1.1	0.76	11°	45	4	7,080
CPRB 2008-4		4				45		7,080
CPRB 2008-6		6				45		7,080
CPRB 2008-8		8				45		7,080
CPRB 2008-10		10				50		7,080

Model Number	Radius of Ball Nose R	Effective Length ℓ_1	Length of Cut ℓ	Neck Diameter ϕd_1	Shank Taper Angle $B\alpha$	Overall Length L	Shank Diameter ϕd	Price ¥
CPRB 2010-3	R0.5	3	1.2	0.93	11°	45	4	6,120
CPRB 2010-4		4				45	4	6,120
CPRB 2010-6		6				45	4	6,120
CPRB 2010-8		8				45	4	6,120
CPRB 2010-10		10				45	4	6,120
CPRB 2010-12		12				45	4	6,120
CPRB 2010-14		14				50	4	6,120
CPRB 2010-16		16				50	4	6,120
CPRB 2010-20		20				55	4	7,200
CPRB 2012-8		R0.6				8	1.3	1.13
CPRB 2012-12	12		45	4	8,000			
CPRB 2014-8	R0.7	8	1.4	1.33	11°	45	4	8,000
CPRB 2014-12		12				45	4	8,000
CPRB 2014-16		16				50	4	8,000
CPRB 2015-6	R0.75	6	1.45	1.43	11°	45	4	6,240
CPRB 2015-8		8				45	4	6,240
CPRB 2015-10		10				45	4	6,240
CPRB 2015-12		12				45	4	6,240
CPRB 2015-16		16				50	4	6,240
CPRB 2015-20		20				55	4	6,240
CPRB 2016-8	R0.8	8	1.5	1.5	11°	45	4	8,000
CPRB 2016-12		12				45	4	8,000
CPRB 2016-16		16				50	4	8,000
CPRB 2016-20		20				55	4	8,000
CPRB 2018-8	R0.9	8	1.6	1.7	11°	45	4	8,000
CPRB 2018-12		12				45	4	8,000
CPRB 2018-16		16				50	4	8,000
CPRB 2018-20		20				55	4	8,000
CPRB 2020-4	R1	4	1.7	1.9	11°	45	4	6,120
CPRB 2020-6		6				45	4	6,120
CPRB 2020-8		8				45	4	6,120
CPRB 2020-10		10				45	4	6,120
CPRB 2020-12		12				45	4	6,120
CPRB 2020-14		14				50	4	6,120
CPRB 2020-16		16				50	4	6,120
CPRB 2020-20		20				55	4	6,120
CPRB 2020-22		22				60	4	6,120
CPRB 2020-25		25				65	4	6,120
CPRB 2020-30		30				70	4	7,440

UDC Series

CBN Series

Square

Long Neck Square

Radius

Long Neck Radius

Taper Neck Radius

Ball / Long Shank Ball

Long Neck Ball

Taper Neck Ball

Taper

Spiral V Cutter

Drill

EURO Series

Technical Data

Unit (mm)

Model Number	Radius of Ball Nose R	Effective Length l_1	Length of Cut l	Neck Diameter ϕd_1	Shank Taper Angle B α	Overall Length L	Shank Diameter ϕd	Price ¥
CPRB 2030-8	R1.5	8	2.5	2.9	11°	60	6	8,640
CPRB 2030-10		10				60	6	8,640
CPRB 2030-12		12				60	6	8,640
CPRB 2030-16		16				60	6	8,640
CPRB 2030-20		20				70	6	8,640
CPRB 2030-25		25				70	6	8,640
CPRB 2030-30		30				70	6	8,640
CPRB 2030-35		35				80	6	10,080
CPRB 2040-10	R2	10	3	3.8	11°	70	6	8,640
CPRB 2040-12		12				70	6	8,640
CPRB 2040-16		16				70	6	8,640
CPRB 2040-20		20				70	6	8,640
CPRB 2040-25		25				70	6	8,640
CPRB 2040-30		30				70	6	8,640
CPRB 2040-35		35				80	6	8,880
CPRB 2040-40		40				90	6	9,120
CPRB 2040-45	45	90	6	10,320				
CPRB 2040-50	50	100	6	11,280				
CPRB 2050-20	R2.5	20	3.5	4.8	11°	70	6	12,080
CPRB 2050-25		25				70	6	12,080
CPRB 2050-30		30				80	6	13,130
CPRB 2050-35		35				80	6	13,130
CPRB 2060-30	R3	30	6	5.8	—	80	6	10,080
CPRB 2060-50		50			—	120	6	12,180

UDC Series

CBN Series

Square

Long Neck Square

Radius

Long Neck Radius

Taper Neck Radius

Ball / Long Shank Ball

Long Neck Ball

Taper Neck Ball

Taper

Spiral V Cutter

Drill

EURO Series

Technical Data

Milling Conditions for CPRB

WORK MATERIAL		ALUMINUM ALLOYS			PLASTICS		
Model Number	Radius of Ball Nose (mm)	Spindle Speed (min ⁻¹)	Feed Rate (mm/min)	axial Depth (mm)	Spindle Speed (min ⁻¹)	Feed Rate (mm/min)	axial Depth (mm)
2004	R0.2	35,000	560	0.005~0.01	35,000	1,100	0.07~0.2
2005	R0.25	35,000	700	0.003~0.01	28,000	1,200	0.08~0.25
2006	R0.3	35,000	910	0.006~0.03	24,000	1,200	0.1 ~0.3
2008	R0.4	26,000	940	0.006~0.05	18,000	900	0.13~0.4
2010	R0.5	21,000	970	0.005~0.08	14,000	700	0.17~0.5
2012	R0.6	18,000	1,010	0.04 ~0.09	12,000	600	0.2 ~0.6
2014	R0.7	15,000	1,020	0.05 ~0.1	10,000	500	0.23~0.7
2015	R0.75	14,000	1,010	0.06 ~0.12	9,500	480	0.25~0.75
2016	R0.8	13,000	1,010	0.08 ~0.13	9,000	450	0.27~0.8
2018	R0.9	12,000	1,060	0.09 ~0.15	8,000	400	0.3 ~0.9
2020	R1	11,000	1,100	0.03 ~0.21	7,000	350	0.33~1
2030	R1.5	6,900	760	0.03 ~0.23	4,800	240	0.5 ~1.5
2040	R2	5,200	690	0.01 ~0.28	3,600	180	0.6 ~2
2050	R2.5	4,200	590	0.16 ~0.31	2,900	150	0.8 ~2.5
2060	R3	3,500	550	0.22 ~0.36	2,400	120	1 ~3

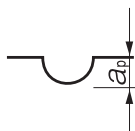

Slotting

 a_p : Axial Depth (mm)

Note:

- Adjust the axial depth (a_p) based on the effective length and milling condition.
- Recommend water soluble coolant for Aluminum Alloys and Copper.
- Recommend air blow for Plastics.
- Remove chips from the work piece to keep the milling surface quality.
- If chips clog on the tool, stop the operation and remove them accordingly.

UDC Series

CBN Series

Square
Long Neck Square

Radius

Long Neck Radius

Taper Neck Radius

Ball / Long Shank Ball

Ball
Long Neck Ball

Taper Neck Ball

Taper

Spiral V Cutter

Drill

EURO Series

Technical Data



Size R0.3~R3

CFLB



R0.3~R1.5

R2~R3

Material Applications (☆ Highly Recommended ○ Recommended ○ Suggested)

Work Material															
Carbon Steels S45C S55C	Alloy Steels SK / SCM SUS	Prehardened Steels NAK HPM	Hardened Steels			Cast Iron	Aluminum Alloys	Graphite	Copper	Plastics	Glass Filled Plastics	Titanium Alloys	Heat Resistant Alloys	Cemented Carbide	Hard Brittle (Non-Metallic) Materials
			~55HRC	~60HRC	~70HRC										
○	○	○	○			○	○		○	○		○	○		

Features

3 flute design that offers higher feed rate milling when compared to a similar specification 2 flute end mill. UTCOAT offers excellent lubricity and longer tool life. Variable pitch design minimizes tool chatter and enables high-precision mold milling. The 3 slots at the tip offers chip evacuation and improved surface finish. (Except R.075 or below) Diameter Tolerance: 0/-0.02

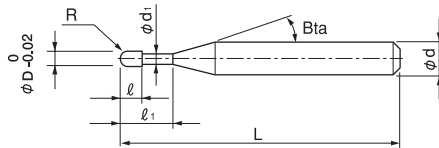

The shank taper angle shown is not an exact value and to avoid contact with the work piece, we recommend the user controls the precise value of this angle. Shank taper angle should not make contact with the work piece.

Total 47 models

Unit (mm)

Model Number	Radius of Ball Nose R	Effective Length l_1	Length of Cut l	Neck Diameter ϕd_1	Shank Taper Angle Bta	Overall Length L	Shank Diameter ϕd	Price ¥	Effective Length by Inclined Angles				
									30°	1°	1°30'	2°	3°
CFLB 3006-020	R0.3	2	0.48	0.58	16°	50	4	6,970	2.16	2.23	2.30	2.37	2.53
CFLB 3006-030		3				50	4	7,130	3.20	3.30	3.40	3.51	3.76
CFLB 3006-040		4				50	4	7,380	4.23	4.36	4.50	4.65	4.98
CFLB 3006-060		6				50	4	7,380	6.30	6.49	6.70	6.93	7.43
CFLB 3008-040	R0.4	4	0.64	0.78	16°	50	4	7,380	4.23	4.36	4.49	4.64	4.96
CFLB 3008-060		6				50	4	7,380	6.29	6.49	6.69	6.91	7.41
CFLB 3008-080		8				50	4	7,380	8.36	8.62	8.89	9.19	9.85
CFLB 3010-025	R0.5	2.5	0.8	0.96	16°	50	4	6,310	2.71	2.79	2.87	2.95	3.14
CFLB 3010-030		3				50	4	6,310	3.23	3.32	3.42	3.52	3.75
CFLB 3010-040		4				50	4	6,560	4.26	4.38	4.52	4.66	4.98
CFLB 3010-050		5				50	4	6,560	5.29	5.45	5.62	5.80	6.20
CFLB 3010-060		6				50	4	6,970	6.32	6.51	6.72	6.94	7.42
CFLB 3010-080		8				50	4	6,970	8.39	8.64	8.92	9.21	9.87
CFLB 3010-100		10				50	4	6,970	10.45	10.77	11.12	11.49	12.32
CFLB 3010-120		12				50	4	6,970	12.51	12.90	13.32	13.77	14.76

Unit (mm)

Model Number	Radius of Ball Nose R	Effective Length l_1	Length of Cut l	Neck Diameter ϕd	Shank Taper Angle $B\alpha$	Overall Length L	Shank Diameter ϕd	Price ¥	Effective Length by Inclined Angles				
									30°	1°	1°30'	2°	3°
CFLB 3015-040	R0.75	4	1.2	1.43	16°	50	4	6,970	4.18	4.29	4.41	4.54	4.83
CFLB 3015-060		6				50	4	6,970	6.24	6.42	6.61	6.82	7.28
CFLB 3015-080		8				50	4	7,220	8.30	8.55	8.82	9.10	9.73
CFLB 3015-100		10				50	4	7,380	10.37	10.68	11.02	11.38	12.18
CFLB 3015-120		12				50	4	7,950	12.43	12.81	13.22	13.65	14.62
CFLB 3015-160		16				50	4	7,950	16.56	17.07	17.62	18.21	19.52
CFLB 3020-040	R1	4	1.6	1.83	16°	50	4	6,300	4.35	4.46	4.58	4.71	4.99
CFLB 3020-060		6				50	4	6,810	6.41	6.59	6.78	6.99	7.44
CFLB 3020-080		8				50	4	6,970	8.48	8.72	8.98	9.26	9.89
CFLB 3020-100		10				50	4	6,970	10.54	10.85	11.18	11.54	12.33
CFLB 3020-120		12				50	4	7,220	12.60	12.98	13.38	13.82	14.78
CFLB 3020-140		14				50	4	7,220	14.66	15.11	15.59	16.09	17.23
CFLB 3020-160		16				50	4	7,220	16.73	17.24	17.79	18.37	19.68
CFLB 3020-180		18				55	4	7,220	18.79	19.37	19.99	20.65	No Interference
CFLB 3020-200		20				55	4	7,220	20.85	21.50	22.19	22.93	No Interference
CFLB 3030-080		R1.5				8	2.4	2.73	16°	60	6	6,970	8.64
CFLB 3030-100	10		60	6	7,630	10.70				11.00	11.33	11.67	12.44
CFLB 3030-120	12		60	6	7,630	12.77				13.14	13.53	13.96	14.89
CFLB 3030-160	16		60	6	7,950	16.89				17.39	17.93	18.50	19.78
CFLB 3030-200	20		70	6	8,040	21.02				21.65	22.33	23.06	24.68
CFLB 3030-250	25		70	6	8,040	26.17				26.98	27.83	28.75	No Interference
CFLB 3040-100	R2	10	3.2	3.63	16°	70	6	7,200	10.87	11.16	11.47	11.80	12.54
CFLB 3040-120		12				70	6	7,380	12.93	13.29	13.67	14.08	14.99
CFLB 3040-160		16				70	6	7,710	17.06	17.55	18.07	18.63	19.89
CFLB 3040-200		20				70	6	8,200	21.18	21.81	22.47	23.19	No Interference
CFLB 3040-250		25				70	6	8,200	26.34	27.13	27.98	28.88	No Interference
CFLB 3040-300		30				70	6	8,200	31.50	32.45	33.48	No Interference	No Interference
CFLB 3060-200	R3	20	4.8	5.42	—	80	6	9,840	No Interference	No Interference	No Interference	No Interference	No Interference
CFLB 3060-250		25				80	6	9,840	No Interference	No Interference	No Interference	No Interference	No Interference
CFLB 3060-300		30				80	6	10,090	No Interference	No Interference	No Interference	No Interference	No Interference
CFLB 3060-350		35				80	6	10,500	No Interference	No Interference	No Interference	No Interference	No Interference
CFLB 3060-400		40				90	6	11,070	No Interference	No Interference	No Interference	No Interference	No Interference

3 Flutes

UDC Series

CBN Series

Square

Long Neck Square

Radius

Long Neck Radius

Taper Neck Radius

Ball / Long Shank Ball

Long Neck Ball

Taper Neck Ball

Taper

Spiral V Cutter

Drill

EURO Series

Technical Data

Milling Conditions for CFLB

WORK MATERIAL			COPPER ALUMINUM ALLOYS C1100 / A5052 / A7075 etc.				CARBON STEELS / ALLOY STEELS / HARDENED STEELS S50C / NAK80 etc. (~45HRC)				HARDENED STEELS STAVAX / SKD61 etc. (~55HRC)			
Coolant			WET				WET / DRY				WET / DRY			
Model Number	Outside Diameter (mm)	Effective Length (mm)	Spindle Speed (min ⁻¹)	Feed Rate (mm/min)	a _p Axial Depth (mm)	a _e Radial Depth (mm)	Spindle Speed (min ⁻¹)	Feed Rate (mm/min)	a _p Axial Depth (mm)	a _e Radial Depth (mm)	Spindle Speed (min ⁻¹)	Feed Rate (mm/min)	a _p Axial Depth (mm)	a _e Radial Depth (mm)
UDC Series	R0.3	2	30,000	1,000	0.03	0.13	30,000	1,000	0.03	0.13	30,000	700	0.03	0.13
		3	30,000	1,000	0.03	0.13	30,000	1,000	0.03	0.13	30,000	700	0.03	0.13
		4	30,000	700	0.02	0.1	30,000	700	0.02	0.1	30,000	480	0.02	0.1
		6	30,000	475	0.01	0.05	30,000	475	0.01	0.05	30,000	300	0.01	0.05
CBN Series	R0.4	4	30,000	1,250	0.04	0.17	30,000	1,250	0.04	0.17	30,000	850	0.04	0.17
		6	30,000	1,000	0.03	0.14	30,000	1,000	0.03	0.14	30,000	680	0.03	0.14
		8	27,000	770	0.018	0.12	27,000	770	0.018	0.12	27,000	510	0.018	0.12
		10	24,100	620	0.023	0.15	24,100	620	0.023	0.15	24,100	440	0.023	0.15
Square	R0.5	2.5	30,000	1,500	0.05	0.21	30,000	1,500	0.05	0.21	30,000	1,000	0.05	0.21
		3	30,000	1,500	0.05	0.21	30,000	1,500	0.05	0.21	30,000	1,000	0.05	0.21
		4	30,000	1,500	0.05	0.21	30,000	1,500	0.05	0.21	30,000	1,000	0.05	0.21
		5	30,000	1,500	0.05	0.21	30,000	1,500	0.05	0.21	30,000	1,000	0.05	0.21
Long Neck Square	R0.5	6	30,000	1,500	0.04	0.19	30,000	1,500	0.04	0.19	30,000	1,000	0.04	0.19
		8	25,200	1,200	0.03	0.17	25,200	1,200	0.03	0.17	25,200	800	0.03	0.17
		10	24,100	930	0.023	0.15	24,100	930	0.023	0.15	24,100	620	0.023	0.155
		12	23,000	660	0.017	0.135	23,000	660	0.017	0.135	23,000	440	0.017	0.135
Radius	R0.75	4	30,000	2,500	0.075	0.32	30,000	2,500	0.075	0.32	30,000	1,700	0.075	0.32
		6	30,000	2,500	0.075	0.32	30,000	2,500	0.075	0.32	30,000	1,700	0.075	0.32
		8	30,000	2,500	0.075	0.32	30,000	2,500	0.075	0.32	30,000	1,700	0.075	0.32
		10	24,000	2,000	0.05	0.26	24,000	2,000	0.05	0.26	24,000	1,350	0.05	0.26
Long Neck Radius	R0.75	12	20,800	1,400	0.035	0.25	20,800	1,400	0.035	0.25	20,800	925	0.035	0.23
		16	17,500	800	0.025	0.24	17,500	800	0.025	0.24	17,500	500	0.017	0.2
		4	30,000	3,200	0.2	0.6	30,000	3,200	0.2	0.6	30,000	2,500	0.2	0.6
		6	30,000	3,200	0.2	0.6	30,000	3,200	0.2	0.6	30,000	2,500	0.2	0.6
Ball / Long Shark Ball	R1	8	30,000	3,200	0.2	0.6	30,000	3,200	0.2	0.6	29,150	2,400	0.2	0.6
		10	27,000	3,000	0.2	0.6	27,000	3,000	0.2	0.6	24,300	2,000	0.2	0.6
		12	21,600	2,400	0.15	0.5	21,600	2,400	0.15	0.5	21,000	1,600	0.14	0.5
		14	16,200	1,600	0.12	0.45	16,200	1,600	0.12	0.45	16,200	1,200	0.08	0.35
Long Neck Ball	R1	16	12,600	1,200	0.1	0.4	12,600	1,200	0.1	0.4	12,600	1,200	0.05	0.3
		18	12,350	1,060	0.07	0.375	12,350	1,060	0.07	0.375	12,350	900	0.035	0.285
		20	12,050	930	0.04	0.35	12,050	930	0.04	0.35	12,050	600	0.017	0.27
		8	24,000	4,000	0.3	0.9	24,000	4,000	0.3	0.9	21,600	2,700	0.3	0.9
Taper Neck Ball	R1.5	10	24,000	4,000	0.3	0.9	24,000	4,000	0.3	0.9	21,600	2,700	0.3	0.9
		12	24,000	3,600	0.3	0.9	24,000	3,600	0.3	0.9	21,600	2,450	0.3	0.9
		16	16,800	2,800	0.27	0.85	16,800	2,800	0.27	0.85	15,100	1,900	0.27	0.85
		20	12,000	2,000	0.24	0.75	12,000	2,000	0.24	0.75	10,800	1,350	0.24	0.75
Taper	R1.5	25	8,400	1,200	0.15	0.65	8,400	1,200	0.15	0.65	7,500	800	0.15	0.65

Milling Conditions for CFLB

WORK MATERIAL			TITANIUM ALLOYS STAINLESS STEELS Ti-6Al-4V / SUS etc.				HEAT RESISTANT ALLOYS Inconel718			
Coolant			WET				WET			
Model Number	Outside Diameter (mm)	Effective Length (mm)	Spindle Speed (min ⁻¹)	Feed Rate (mm/min)	a_p Axial Depth (mm)	a_e Radial Depth (mm)	Spindle Speed (min ⁻¹)	Feed Rate (mm/min)	a_p Axial Depth (mm)	a_e Radial Depth (mm)
3006-020	R0.3	2	20,000	1,000	0.015	0.09	9,000	225	0.015	0.09
3006-030		3	20,000	1,000	0.015	0.09	7,500	185	0.012	0.08
3006-040		4	20,000	700	0.01	0.07	4,500	100	0.01	0.07
3006-060		6	20,000	200	0.005	0.035	2,400	30	0.004	0.035
3008-040	R0.4	4	20,000	1,250	0.02	0.12	10,000	310	0.02	0.12
3008-060		6	20,000	950	0.013	0.075	7,200	200	0.013	0.075
3008-080		8	18,000	600	0.007	0.06	4,450	95	0.007	0.06
3010-025	R0.5	2.5	20,000	1,500	0.025	0.15	10,000	375	0.025	0.15
3010-030		3	20,000	1,500	0.025	0.15	10,000	375	0.025	0.15
3010-040		4	20,000	1,500	0.025	0.15	9,000	330	0.025	0.15
3010-050		5	20,000	1,500	0.025	0.15	7,500	280	0.02	0.14
3010-060		6	20,000	1,500	0.02	0.14	6,000	220	0.02	0.13
3010-080		8	16,800	1,200	0.015	0.12	3,500	110	0.015	0.11
3010-100		10	16,050	930	0.011	0.1	3,350	85	0.011	0.095
3010-120		12	15,300	660	0.008	0.095	3,200	60	0.008	0.085
3015-040	R0.75	4	20,000	2,500	0.035	0.22	9,000	380	0.03	0.22
3015-060		6	20,000	2,500	0.035	0.22	9,000	380	0.03	0.22
3015-080		8	20,000	2,500	0.035	0.22	6,000	250	0.025	0.18
3015-100		10	16,000	2,000	0.025	0.19	4,500	170	0.02	0.17
3015-120		12	14,000	1,370	0.02	0.18	4,100	135	0.017	0.17
3015-160		16	12,000	730	0.013	0.17	3,600	100	0.013	0.165
3020-040	R1	4	20,000	3,200	0.1	0.43	12,000	1,000	0.1	0.4
3020-060		6	20,000	3,200	0.1	0.43	12,000	1,000	0.1	0.4
3020-080		8	20,000	3,200	0.1	0.43	10,800	900	0.1	0.4
3020-100		10	18,000	3,000	0.1	0.43	9,000	750	0.08	0.36
3020-120		12	14,400	2,400	0.075	0.38	7,200	600	0.08	0.34
3020-140		14	10,800	1,600	0.06	0.34	5,400	400	0.07	0.32
3020-160		16	8,400	1,200	0.05	0.34	4,200	300	0.06	0.3
3020-180		18	8,250	1,000	0.035	0.26	4,100	250	0.035	0.26
3020-200		20	8,050	800	0.017	0.245	4,000	200	0.015	0.23
3030-080		R1.5	8	16,000	4,000	0.15	0.65	8,000	1,000	0.15
3030-100	10		16,000	4,000	0.15	0.65	7,200	900	0.15	0.65
3030-120	12		16,000	3,600	0.15	0.65	7,200	800	0.15	0.65
3030-160	16		11,200	2,800	0.135	0.62	4,800	600	0.12	0.55
3030-200	20		8,000	2,000	0.12	0.58	3,600	400	0.1	0.52
3030-250	25		5,600	1,200	0.075	0.46	2,800	300	0.09	0.48

UDC Series

CBN Series

Square

Long Neck Square

Radius

Long Neck Radius

Taper Neck Radius

Ball / Long Shank Ball

Long Neck Ball

Taper Neck Ball

Taper

Spiral V Cutter

Drill

EURO Series

Technical Data

Milling Conditions for CFLB

WORK MATERIAL			COPPER ALUMINUM ALLOYS C1100 / A5052 / A7075 etc.				CARBON STEELS / ALLOY STEELS / HARDENED STEELS S50C / NAK80 etc (~45HRC)				HARDENED STEELS STAVAX / SKD61 etc. (~55HRC)			
Coolant			WET				WET / DRY				WET / DRY			
Model Number	Outside Diameter (mm)	Effective Length (mm)	Spindle Speed (min ⁻¹)	Feed Rate (mm/min)	a _p Axial Depth (mm)	a _e Radial Depth (mm)	Spindle Speed (min ⁻¹)	Feed Rate (mm/min)	a _p Axial Depth (mm)	a _e Radial Depth (mm)	Spindle Speed (min ⁻¹)	Feed Rate (mm/min)	a _p Axial Depth (mm)	a _e Radial Depth (mm)
3040-100	R2	10	18,000	4,000	0.4	1.2	18,000	4,000	0.4	1.2	16,200	2,700	0.4	1.2
3040-120		12	18,000	4,000	0.4	1.2	18,000	4,000	0.4	1.2	16,200	2,700	0.4	1.2
3040-160		16	16,200	3,600	0.4	1.2	16,200	3,600	0.4	1.2	14,600	2,450	0.4	1.2
3040-200		20	13,500	3,000	0.4	1.2	13,500	3,000	0.4	1.2	12,200	2,000	0.4	1.2
3040-250		25	9,900	2,200	0.32	1.05	9,900	2,200	0.32	1.05	8,900	1,450	0.32	1.05
3040-300		30	7,200	1,400	0.2	0.85	7,200	1,400	0.2	0.85	6,500	950	0.2	0.85
3060-200	R3	20	12,000	4,000	0.6	1.8	12,000	4,000	0.6	1.8	10,800	2,700	0.6	1.8
3060-250		25	10,500	3,500	0.6	1.8	10,500	3,500	0.6	1.8	9,450	2,350	0.6	1.8
3060-300		30	9,000	3,000	0.6	1.8	9,000	3,000	0.6	1.8	8,100	2,000	0.6	1.8
3060-350		35	7,500	2,500	0.6	1.8	7,500	2,500	0.5	1.6	6,750	1,650	0.5	1.6
3060-400		40	6,000	2,000	0.4	1.4	6,000	2,000	0.4	1.4	5,400	1,350	0.4	1.4

a_p : Axial Depth (mm)
a_e : Radial Depth (mm)

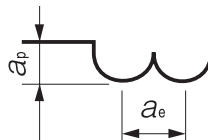

Note:

- Decrease the feed rate more than 50% from the milling parameters when slot milling.
- Decrease both spindle speed and feed rate proportionally when the milling parameters exceed the machines maximum speed, or when the tool is chattering and heats up to a red color.
- Recommend wet coolant for Copper.
- DRY: air blow, WET: water soluble or oil coolant.

Milling Conditions for CFLB

WORK MATERIAL			TITANIUM ALLOYS STAINLESS STEELS Ti-6Al-4V / SUS etc.				HEAT RESISTANT ALLOYS Inconel718			
Coolant			WET				WET			
Model Number	Outside Diameter (mm)	Effective Length (mm)	Spindle Speed (min ⁻¹)	Feed Rate (mm/min)	a _p Axial Depth (mm)	a _e Radial Depth (mm)	Spindle Speed (min ⁻¹)	Feed Rate (mm/min)	a _p Axial Depth (mm)	a _e Radial Depth (mm)
3040-100	R2	10	12,000	4,000	0.2	0.87	6,000	1,000	0.2	0.85
3040-120		12	12,000	4,000	0.2	0.87	6,000	1,000	0.2	0.85
3040-160		16	10,800	3,600	0.2	0.87	5,400	900	0.2	0.85
3040-200		20	9,000	3,000	0.2	0.87	4,500	750	0.17	0.76
3040-250		25	6,600	2,200	0.16	0.78	2,700	400	0.14	0.68
3040-300		30	4,800	1,400	0.1	0.62	2,100	300	0.12	0.63
3060-200	R3	20	8,000	4,000	0.3	1.3	3,600	900	0.3	1.3
3060-250		25	7,000	3,500	0.3	1.3	3,300	820	0.27	1.2
3060-300		30	6,000	3,000	0.3	1.3	3,000	750	0.25	1.17
3060-350		35	5,000	2,500	0.25	1.15	2,400	570	0.23	1.1
3060-400		40	4,000	2,000	0.2	1.05	1,800	400	0.21	1.04

Tool Life Comparison with Conventional Model (2 flutes) R0.3 x Effective Length 3mm

S50C Pocket Milling

Milling Conditions

Spindle Speed	30,000 min ⁻¹
Feed Rate	1,000 mm/min
Axial Depth a _p	0.03 mm
Radial Depth a _e	0.13 mm
Coolant	Air Blow (Through Spindle)
Overhang Length	12 mm
Pocket Size	φ5 × 3 mm
Cycle Time	14 min/pocket

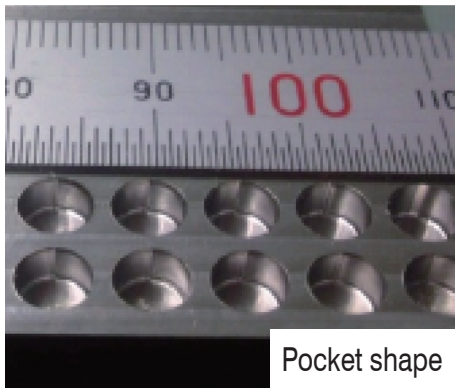
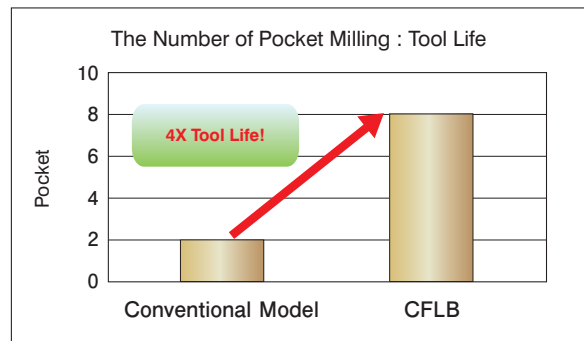
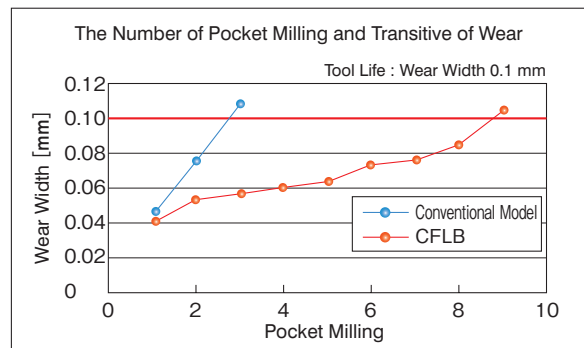

- UDC Series
- CBN Series
- Square
- Long Neck Square
- Radius
- Long Neck Radius
- Taper Neck Radius
- Ball / Long Shank Ball
- Long Neck Ball
- Taper Neck Ball
- Taper
- Spiral V Cutter
- Drill
- EURO Series
- Technical Data



Size R0.1~R2

HTNB



Additional 48 models

Material Applications (☆ Highly Recommended ● Recommended ○ Suggested)

Work Material															
Carbon Steels S45C S55C	Alloy Steels SK / SCM SUS	Prehardened Steels NAK HPM	Hardened Steels			Cast Iron	Aluminum Alloys	Graphite	Copper	Plastics	Glass Filled Plastics	Titanium Alloys	Heat Resistant Alloys	Cemented Carbide	Hard Brittle (Non-Metallic) Materials
			~55HRC	~60HRC	~70HRC										
○	○	●	●	●	○			●				○	○		

Total 245 models

Model Number	Radius of Ball Nose R	Neck Taper Angle TN	Neck Length ℓ ₂	Effective Length ℓ ₁	Length of Cut ℓ	Neck Diameter φ _{d₁}	Shank Taper Angle B _{ta}	Overall Length L	Shank Diameter φ _d	Shape	Price ¥																
HTNB 2002-015-1	R0.1	30°	1.5	—	0.16	—	16°	50	4	A	11,520																
HTNB 2002-020-1			2					50	4		12,120																
HTNB 2002-030-1			3					50	4		14,400																
HTNB 2002-015-2		1°	30°					1.5	—		0.16	—	16°	50	4	A	11,520										
HTNB 2002-020-2								2						50	4		12,120										
HTNB 2002-030-2								3						50	4		14,400										
HTNB 2002-015-3		1°30'	30°					1.5						—	0.16		—	16°	50	4	A	11,520					
HTNB 2002-020-3								2											50	4		12,120					
HTNB 2002-030-3								3											50	4		14,400					
HTNB 2003-020-1		R0.15	30°					2											—	0.24		—	16°	50	4	A	11,520
HTNB 2003-030-1								3																50	4		12,120
HTNB 2003-020-2								2																50	4		11,520
HTNB 2003-030-2	3		50	4	12,120																						
HTNB 2003-020-3	1°30'		30°	2	—	0.24	—	16°		50														4	A		11,520
HTNB 2003-030-3				3						50														4			12,120
HTNB 2004-030-1	R0.2	30°	3	—					0.32	—	16°	50	4			A			8,880								
HTNB 2004-040-1			4									50	4						8,880								
HTNB 2004-060-1			6									50	4						9,600								
HTNB 2004-030-2			1°									30°	3	—	0.32		—	16°	50	4	A	8,880					
HTNB 2004-040-2					4	50	4	8,880																			
HTNB 2004-060-2					6	50	4	9,600																			
HTNB 2004-030-3		1°30'			30°	3	—	0.32					—						16°	50		4	A	8,880			
HTNB 2004-040-3						4														50		4		8,880			
HTNB 2004-060-3						6														50		4		9,600			

Features

Taper Neck design offers high rigidity.
 Stable milling and excellent surface even on deep milling.
 HARDMAX coat offers heat resistance, toughness and lubricity at a high level.
 Suitable for hard materials up to 65HRC.

The shank taper angle shown is not an exact value and to avoid contact with the work piece, we recommend the user controls the precise value of this angle. Shank taper angle should not make contact with the work piece.

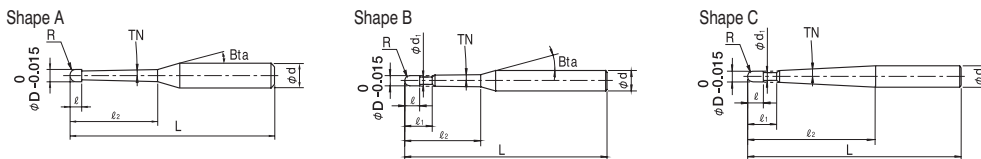
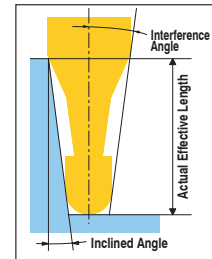

Unit (mm)

Model Number	Radius of Ball Nose R	Neck Taper Angle TN	Neck Length ℓ_2	Interference Angle	Effective Length by Inclined Angles — : Interference					
					30°	1°	1°30'	2°	3°	
HTNB 2002-015-1	RO.1	30°	1.5	13.36°	—	1.50	1.55	1.60	1.72	
HTNB 2002-020-1			2	12.63°	—	2.01	2.08	2.15	2.31	
HTNB 2002-030-1			3	11.37°	—	3.05	3.15	3.26	3.50	
HTNB 2002-015-2		1°	1°	1.5	13.41°	—	—	1.51	1.56	1.68
HTNB 2002-020-2				2	12.69°	—	—	2.03	2.10	2.25
HTNB 2002-030-2				3	11.46°	—	—	3.06	3.17	3.40
HTNB 2002-015-3		1°30'	1°30'	1.5	13.46°	—	—	—	1.53	1.64
HTNB 2002-020-3				2	12.76°	—	—	—	2.04	2.19
HTNB 2002-030-3				3	11.56°	—	—	—	3.08	3.31
HTNB 2003-020-1		RO.15	30°	2	12.62°	—	2.01	2.08	2.15	2.30
HTNB 2003-030-1				3	11.34°	—	3.05	3.15	3.25	3.49
HTNB 2003-020-2			1°	1°	2	12.68°	—	—	2.03	2.10
HTNB 2003-030-2	3				11.43°	—	—	3.06	3.17	3.40
HTNB 2003-020-3	1°30'		1°30'	2	12.75°	—	—	—	2.05	2.19
HTNB 2003-030-3				3	11.52°	—	—	—	3.08	3.31
HTNB 2004-030-1	RO.2	30°	3	11.30°	—	3.04	3.14	3.25	3.48	
HTNB 2004-040-1			4	10.23°	—	4.08	4.21	4.35	4.67	
HTNB 2004-060-1			6	8.60°	—	6.14	6.34	6.56	7.04	
HTNB 2004-030-2		1°	1°	3	11.38°	—	—	3.06	3.17	3.39
HTNB 2004-040-2				4	10.33°	—	—	4.10	4.23	4.54
HTNB 2004-060-2				6	8.72°	—	—	6.16	6.37	6.84
HTNB 2004-030-3		1°30'	1°30'	3	11.48°	—	—	—	3.08	3.30
HTNB 2004-040-3				4	10.44°	—	—	—	4.12	4.42
HTNB 2004-060-3				6	8.84°	—	—	—	6.19	6.64

Next Page ➔

UDC Series

CBN Series

Square

Long Neck Square

Radius

Long Neck Radius

Taper Neck Radius

Ball / Long Shank Ball

Long Neck Ball

Taper Neck Ball

Taper

Spiral V Cutter

Drill

EURO Series

Technical Data

2 Flutes HARDMAX

Model Number	Radius of Ball Nose R	Neck Taper Angle TN	Neck Length ℓ_2	Effective Length ℓ_1	Length of Cut ℓ	Neck Diameter ϕd_1	Shank Taper Angle Bta	Overall Length L	Shank Diameter ϕd	Shape	Price ¥
HTNB 2005-040-1	R0.25	30°	4	—	0.4	—	16°	50	4	A	8,400
HTNB 2005-060-1			6					8,880			
HTNB 2005-080-1			8					8,880			
HTNB 2005-100-1			10					9,600			
HTNB 2005-040-2		1°	4					8,400			
HTNB 2005-060-2			6					8,880			
HTNB 2005-080-2			8					8,880			
HTNB 2005-100-2			10					9,600			
HTNB 2005-040-3		1°30'	4					8,640			
HTNB 2005-060-3			6					8,880			
HTNB 2005-080-3			8					8,880			
HTNB 2005-100-3			10					9,600			
HTNB 2006-040-1	R0.3	30°	4	0.9	0.48	0.56	16°	50	4	B	8,280
HTNB 2006-060-1			6					8,520			
HTNB 2006-080-1			8					8,520			
HTNB 2006-100-1			10					8,640			
HTNB 2006-120-1			12					9,360			
HTNB 2006-140-1			14					9,360			
HTNB 2006-160-1			16					9,360			
HTNB 2006-200-1			20					12,500			
HTNB 2006-040-2		1°	4					8,280			
HTNB 2006-060-2			6					8,520			
HTNB 2006-080-2			8					8,520			
HTNB 2006-100-2			10					8,640			
HTNB 2006-120-2			12					9,360			
HTNB 2006-140-2			14					9,360			
HTNB 2006-160-2			16					9,360			
HTNB 2006-200-2			20					12,500			
HTNB 2006-040-3		1°30'	4					8,280			
HTNB 2006-060-3			6					8,520			
HTNB 2006-080-3			8					8,520			
HTNB 2006-100-3			10					8,640			
HTNB 2006-120-3			12					9,360			
HTNB 2006-140-3			14					9,360			
HTNB 2006-160-3			16					9,360			
HTNB 2006-200-3			20					12,500			
HTNB 2006-080-4		2°	8					8,520			
HTNB 2006-120-4			12					9,360			
HTNB 2006-200-4			20					12,500			
HTNB 2006-080-6			3°					8	8,520		
HTNB 2006-120-6	12	9,360									
HTNB 2006-200-6	20	12,500									
HTNB 2006-120-10	5°	12		9,360							
HTNB 2006-200-10		20	12,500								

※Additional model

UDC Series

CBN Series

Square
Long Neck Square

Radius
Long Neck Radius
Taper Neck Radius

Ball / Long Shank Ball
Long Neck Ball
Taper Neck Ball

Taper

Spiral V Cutter

Drill

EURO Series

Technical Data

Unit (mm)

Model Number	Radius of Ball Nose R	Neck Taper Angle TN	Neck Length ℓ_2	Interference Angle	Effective Length by Inclined Angles — : Interference					
					30°	1°	1°30'	2°	3°	
HTNB 2005-040-1	R0.25	30°	4	10.17°	—	4.08	4.21	4.35	4.66	
HTNB 2005-060-1			6	8.52°	—	6.14	6.34	6.55	7.03	
HTNB 2005-080-1			8	7.33°	—	8.21	8.48	8.76	9.41	
HTNB 2005-100-1			10	6.43°	—	10.27	10.61	10.97	11.78	
HTNB 2005-040-2		1°	30°	4	10.27°	—	—	4.10	4.23	4.54
HTNB 2005-060-2				6	8.64°	—	—	6.16	6.37	6.84
HTNB 2005-080-2				8	7.45°	—	—	8.23	8.51	9.13
HTNB 2005-100-2				10	6.55°	—	—	10.30	10.65	11.43
HTNB 2005-040-3		1°30'	30°	4	10.38°	—	—	—	4.12	4.41
HTNB 2005-060-3				6	8.76°	—	—	—	6.19	6.64
HTNB 2005-080-3				8	7.57°	—	—	—	8.26	8.86
HTNB 2005-100-3				10	6.67°	—	—	—	10.33	11.09
HTNB 2006-040-1	R0.3	30°	4	10.10°	—	4.08	4.21	4.34	4.65	
HTNB 2006-060-1			6	8.44°	—	6.14	6.34	6.55	7.03	
HTNB 2006-080-1			8	7.24°	—	8.21	8.47	8.76	9.40	
HTNB 2006-100-1			10	6.33°	—	10.27	10.61	10.97	11.77	
HTNB 2006-120-1			12	5.63°	—	12.34	12.74	13.18	14.14	
HTNB 2006-140-1			14	5.07°	—	14.39	14.87	15.37	16.51	
HTNB 2006-160-1			16	4.61°	—	16.46	17.01	17.59	18.89	
HTNB 2006-200-1			20	3.90°	—	20.60	21.28	22.01	23.64	
HTNB 2006-040-2		1°	30°	4	10.21°	—	—	4.10	4.23	4.53
HTNB 2006-060-2				6	8.55°	—	—	6.17	6.37	6.83
HTNB 2006-080-2				8	7.36°	—	—	8.23	8.51	9.13
HTNB 2006-100-2				10	6.45°	—	—	10.30	10.65	11.43
HTNB 2006-120-2				12	5.74°	—	—	12.37	12.79	13.72
HTNB 2006-140-2				14	5.18°	—	—	14.43	14.93	16.03
HTNB 2006-160-2				16	4.71°	—	—	16.50	17.07	18.32
HTNB 2006-200-2				20	3.99°	—	—	20.64	21.34	22.92
HTNB 2006-040-3		1°30'	30°	4	10.31°	—	—	—	4.12	4.41
HTNB 2006-060-3				6	8.67°	—	—	—	6.19	6.64
HTNB 2006-080-3				8	7.48°	—	—	—	8.26	8.86
HTNB 2006-100-3				10	6.57°	—	—	—	10.34	11.09
HTNB 2006-120-3				12	5.86°	—	—	—	12.40	13.31
HTNB 2006-140-3				14	5.29°	—	—	—	14.46	15.52
HTNB 2006-160-3				16	4.82°	—	—	—	16.54	17.76
HTNB 2006-200-3				20	4.09°	—	—	—	20.67	22.19
HTNB 2006-080-4	2°	30°	8	7.60°	—	—	—	8.59		
HTNB 2006-120-4			12	5.98°	—	—	—	12.89		
HTNB 2006-200-4			20	4.19°	—	—	—	21.49		
HTNB 2006-080-6	3°	30°	8	7.86°	—	—	—	—		
HTNB 2006-120-6			12	6.23°	—	—	—	—		
HTNB 2006-200-6			20	4.41°	—	—	—	—		
HTNB 2006-120-10	5°	30°	12	6.82°	—	—	—	—		
HTNB 2006-200-10			20	4.92°	—	—	—	—		

Next Page ➡

UDC Series

CBN Series

Square

Long Neck Square

Radius

Long Neck Radius

Taper Neck Radius

Ball / Long Shank Ball

Long Neck Ball

Taper Neck Ball

Taper

Spiral V Cutter

Drill

EURO Series

Technical Data

Model Number	Radius of Ball Nose R	Neck Taper Angle TN	Neck Length ℓ_2	Effective Length ℓ_1	Length of Cut ℓ	Neck Diameter ϕd_1	Shank Taper Angle Bta	Overall Length L	Shank Diameter ϕd	Shape	Price ¥
HTNB 2008-060-1	RO.4	30°	6	1.2	0.64	0.76	16°	50	4	B	8,880
HTNB 2008-080-1			8					50	4		8,880
HTNB 2008-120-1			12					60	4		9,360
HTNB 2008-160-1			16					60	4		11,500
HTNB 2008-060-2		1°	6					50	4		8,880
HTNB 2008-080-2			8					50	4		8,880
HTNB 2008-120-2			12					60	4		9,360
HTNB 2008-160-2			16					60	4		11,500
HTNB 2008-060-3		1°30'	6					50	4		8,880
HTNB 2008-080-3			8					50	4		8,880
HTNB 2008-120-3			12					60	4		9,360
HTNB 2008-160-3			16					60	4		11,500
HTNB 2010-060-1	RO.5	30°	6	1.5	0.8	0.95	16°	50	4	B	7,560
HTNB 2010-080-1			8					50	4		7,560
HTNB 2010-100-1			10					50	4		7,560
HTNB 2010-120-1			12					50	4		7,560
※ HTNB 2010-140-1		14	50					4	7,560		
HTNB 2010-160-1		16	50					4	7,560		
※ HTNB 2010-180-1		18	50					4	7,560		
HTNB 2010-200-1		20	60					4	9,600		
HTNB 2010-220-1		22	60					4	9,600		
HTNB 2010-260-1		26	65					4	10,080		
※ HTNB 2010-300-1		30	70					4	10,560		
HTNB 2010-320-1		32	70					4	10,560		
HTNB 2010-360-1	36	80	4	11,040							

※Additional model

UDC Series

CBN Series

Square

Long Neck Square

Radius

Long Neck Radius

Taper Neck Radius

※ Ball / Long Shank Ball

※ Long Neck Ball

Taper Neck Ball

※ Taper

Spiral V Cutter

Drill

EURO Series

Technical Data

Unit (mm)

Model Number	Radius of Ball Nose R	Neck Taper Angle TN	Neck Length ℓ_2	Interference Angle	Effective Length by Inclined Angles — : Interference				
					30°	1°	1°30'	2°	3°
HTNB 2008-060-1	RO.4	30°	6	8.26°	—	6.14	6.34	6.54	7.01
HTNB 2008-080-1			8	7.04°	—	8.21	8.47	8.75	9.38
HTNB 2008-120-1			12	5.44°	—	12.33	12.74	13.17	14.13
HTNB 2008-160-1			16	4.43°	—	16.47	17.01	17.59	18.88
HTNB 2008-060-2		1°	6	8.37°	—	—	6.17	6.37	6.82
HTNB 2008-080-2			8	7.16°	—	—	8.23	8.51	9.12
HTNB 2008-120-2			12	5.55°	—	—	12.37	12.79	13.72
HTNB 2008-160-2			16	4.53°	—	—	16.50	17.06	18.31
HTNB 2008-060-3		1°30'	6	8.49°	—	—	—	6.20	6.64
HTNB 2008-080-3			8	7.28°	—	—	—	8.26	8.86
HTNB 2008-120-3			12	5.67°	—	—	—	12.40	13.30
HTNB 2008-160-3			16	4.63°	—	—	—	16.54	17.75
HTNB 2010-060-1	RO.5	30°	6	8.06°	—	6.14	6.33	6.54	7.00
HTNB 2010-080-1			8	6.84°	—	8.21	8.47	8.75	9.37
HTNB 2010-100-1			10	5.93°	—	10.27	10.60	10.96	11.74
HTNB 2010-120-1			12	5.24°	—	12.33	12.73	13.16	14.11
HTNB 2010-140-1			14	4.69°	—	14.39	14.85	15.35	16.47
HTNB 2010-160-1			16	4.25°	—	16.46	17.00	17.58	18.86
HTNB 2010-180-1			18	3.88°	—	18.51	19.12	19.77	21.21
HTNB 2010-200-1			20	3.57°	—	20.60	21.27	22.00	23.61
HTNB 2010-220-1			22	3.31°	—	22.66	23.41	24.20	25.98
HTNB 2010-260-1			26	2.88°	—	26.79	27.67	28.62	No Interference
HTNB 2010-300-1			30	2.55°	—	30.90	31.93	33.02	No Interference
HTNB 2010-320-1			32	2.41°	—	32.98	34.07	35.24	No Interference
HTNB 2010-360-1	36	2.18°	—	37.11	38.34	39.66	No Interference		

Next Page ➔

UDC Series

CBN Series

Square

Long Neck Square

Radius

Long Neck Radius

Taper Neck Radius

Ball / Long Shank Ball

Long Neck Ball

Taper Neck Ball

Taper

Spiral V Cutter

Drill

EURO Series

Technical Data

2 Flutes HARDMAX

Model Number	Radius of Ball Nose R	Neck Taper Angle TN	Neck Length ℓ_2	Effective Length ℓ_1	Length of Cut ℓ	Neck Diameter ϕd_1	Shank Taper Angle Bta	Overall Length L	Shank Diameter ϕd	Shape	Price ¥	
HTNB 2010-060-2	R0.5	1°	6	1.5	0.8	0.95	16°	50	4	B	7,560	
HTNB 2010-080-2			8					50	4		7,560	
HTNB 2010-100-2			10					50	4		7,560	
HTNB 2010-120-2			12					50	4		7,560	
HTNB 2010-140-2			14					50	4		7,560	
HTNB 2010-160-2			16					50	4		7,560	
HTNB 2010-180-2			18					50	4		7,560	
HTNB 2010-200-2			20					60	4		9,600	
HTNB 2010-220-2			22					60	4		9,600	
HTNB 2010-260-2			26					65	4		10,080	
※ HTNB 2010-300-2			30					70	4		10,560	
HTNB 2010-320-2			32					70	4		10,560	
HTNB 2010-360-2		36	80					4	11,040			
HTNB 2010-060-3		1°30'	6					50	4		7,560	
HTNB 2010-080-3			8					50	4		7,560	
HTNB 2010-100-3			10					50	4		7,560	
HTNB 2010-120-3			12					50	4		7,560	
※ HTNB 2010-140-3			14					50	4		7,560	
HTNB 2010-160-3			16					50	4		7,560	
※ HTNB 2010-180-3			18					50	4		7,560	
HTNB 2010-200-3			20					60	4		9,600	
HTNB 2010-220-3			22					60	4		9,600	
HTNB 2010-260-3			26					65	4		10,080	
※ HTNB 2010-300-3			30					70	4		10,560	
HTNB 2010-320-3			32					70	4		10,560	
HTNB 2010-360-3		36	80					4	11,040			
※ HTNB 2010-120-4		2°	12					50	4		7,560	
※ HTNB 2010-160-4			16					50	4		7,560	
※ HTNB 2010-200-4			20					60	4		9,600	
※ HTNB 2010-300-4			30					70	4		10,560	
※ HTNB 2010-120-6		3°	12					50	4		7,560	
※ HTNB 2010-160-6			16					50	4		7,560	
※ HTNB 2010-200-6			20					60	4		9,600	
※ HTNB 2010-298-6			29.8					—	70		4	C
※ HTNB 2010-120-10		5°	12					50	4		7,560	
※ HTNB 2010-200-10			20					70	6		B	9,600

※Additional model

Unit (mm)

Model Number	Radius of Ball Nose R	Neck Taper Angle TN	Neck Length ℓ_2	Interference Angle	Effective Length by Inclined Angles — : Interference						
					30°	1°	1°30'	2°	3°		
HTNB 2010-060-2	RO.5	1°	6	8.17°	—	—	6.18	6.38	6.82		
HTNB 2010-080-2			8	6.95°	—	—	8.24	8.51	9.12		
HTNB 2010-100-2			10	6.04°	—	—	10.31	10.66	11.42		
HTNB 2010-120-2			12	5.35°	—	—	12.38	12.79	13.72		
HTNB 2010-140-2			14	4.79°	—	—	14.45	14.93	16.02		
HTNB 2010-160-2			16	4.34°	—	—	16.51	17.07	18.31		
HTNB 2010-180-2			18	3.97°	—	—	18.58	19.21	20.61		
HTNB 2010-200-2			20	3.65°	—	—	20.64	21.35	22.91		
HTNB 2010-220-2			22	3.39°	—	—	22.71	23.48	25.21		
HTNB 2010-260-2			26	2.95°	—	—	26.85	27.76	No Interference		
HTNB 2010-300-2			30	2.62°	—	—	30.97	32.03	No Interference		
HTNB 2010-320-2			32	2.48°	—	—	33.05	34.18	No Interference		
HTNB 2010-360-2		36	2.24°	—	—	37.18	38.46	No Interference			
HTNB 2010-060-3		1°30'	1°30'	6	8.28°	—	—	—	6.21	6.65	
HTNB 2010-080-3				8	7.06°	—	—	—	8.28	8.87	
HTNB 2010-100-3				10	6.16°	—	—	—	10.35	11.10	
HTNB 2010-120-3				12	5.45°	—	—	—	12.42	13.32	
HTNB 2010-140-3				14	4.90°	—	—	—	14.47	15.52	
HTNB 2010-160-3				16	4.44°	—	—	—	16.56	17.77	
HTNB 2010-180-3				18	4.06°	—	—	—	18.61	19.97	
HTNB 2010-200-3				20	3.74°	—	—	—	20.70	22.21	
HTNB 2010-220-3				22	3.47°	—	—	—	22.77	24.44	
HTNB 2010-260-3				26	3.03°	—	—	—	26.91	28.88	
HTNB 2010-300-3				30	2.69°	—	—	—	31.03	No Interference	
HTNB 2010-320-3				32	2.55°	—	—	—	33.11	No Interference	
HTNB 2010-360-3		36	2.30°	—	—	—	37.25	No Interference			
HTNB 2010-120-4		2°	2°	12	5.57°	—	—	—	—	12.88	
HTNB 2010-160-4				16	4.55°	—	—	—	—	—	17.18
HTNB 2010-200-4				20	3.84°	—	—	—	—	—	21.48
HTNB 2010-300-4				30	2.77°	—	—	—	—	—	No Interference
HTNB 2010-120-6		3°	3°	12	5.82°	—	—	—	—	—	
HTNB 2010-160-6				16	4.77°	—	—	—	—	—	—
HTNB 2010-200-6				20	4.05°	—	—	—	—	—	—
HTNB 2010-298-6		5°	5°	29.8	—	—	—	—	—	—	
HTNB 2010-120-10				12	6.38°	—	—	—	—	—	—
HTNB 2010-200-10				20	6.35°	—	—	—	—	—	—

UDC Series

CBN Series

Square

Long Neck Square

Radius

Long Neck Radius

Taper Neck Radius

Ball / Long Shank Ball

Long Neck Ball

Taper Neck Ball

Taper

Spiral V Cutter

Drill

EURO Series

Technical Data

Next Page ➡

2 Flutes HARDMAX

Model Number	Radius of Ball Nose R	Neck Taper Angle TN	Neck Length ℓ_2	Effective Length ℓ_1	Length of Cut ℓ	Neck Diameter ϕd_1	Shank Taper Angle Bta	Overall Length L	Shank Diameter ϕd	Shape	Price ¥	
HTNB 2015-100-1	R0.75	30°	10	2.25	1.2	1.42	16°	60	4	B	7,920	
HTNB 2015-120-1			12					60	4		7,920	
HTNB 2015-160-1			16					60	4		8,640	
HTNB 2015-200-1			20					60	4		8,640	
HTNB 2015-220-1			22					60	4		8,640	
HTNB 2015-260-1			26					70	4		9,360	
HTNB 2015-300-1		30	70					4	9,360			
HTNB 2015-360-1		36	80					4	11,040			
HTNB 2015-100-2		1°	10					60	4		7,920	
HTNB 2015-120-2			12					60	4		7,920	
HTNB 2015-160-2			16					60	4		8,640	
HTNB 2015-200-2			20					60	4		8,640	
HTNB 2015-260-2			26					70	4		9,360	
HTNB 2015-300-2			30					70	4		9,360	
HTNB 2015-360-2		36	80					4	11,040			
HTNB 2015-100-3		1°30'	10					60	4		7,920	
HTNB 2015-120-3			12					60	4		7,920	
HTNB 2015-160-3			16					60	4		8,640	
HTNB 2015-200-3			20					60	4		8,640	
HTNB 2015-260-3			26					70	4		9,360	
HTNB 2015-300-3			30					70	4		9,360	
HTNB 2015-360-3			36					80	4		11,040	
※ HTNB 2015-120-4			2°					12	60		4	7,920
※ HTNB 2015-160-4								16	60		4	8,640
※ HTNB 2015-200-4								20	60		4	8,640
※ HTNB 2015-300-4								30	70		6	11,040
※ HTNB 2015-120-6			3°					12	60		4	7,920
※ HTNB 2015-160-6		16						60	4		8,640	
※ HTNB 2015-200-6		20						60	4		8,640	
※ HTNB 2015-300-6		30						70	6		11,040	

※Additional model

UDC Series

CBN Series

Square

Long Neck Square

Radius

Long Neck Radius

Ball / Long Shank Ball

Long Neck Ball

Taper Neck Ball

Taper

Spiral V Cutter

Drill

EURO Series

Technical Data

Unit (mm)

Model Number	Radius of Ball Nose R	Neck Taper Angle TN	Neck Length ℓ_2	Interference Angle	Effective Length by Inclined Angles — : Interference				
					30°	1°	1°30'	2°	3°
HTNB 2015-100-1	R0.75	30°	10	5.36°	—	10.27	10.59	10.93	11.70
HTNB 2015-120-1			12	4.69°	—	12.33	12.72	13.14	14.08
HTNB 2015-160-1			16	3.75°	—	16.46	16.99	17.56	18.82
HTNB 2015-200-1			20	3.12°	—	20.59	21.26	21.98	23.57
HTNB 2015-220-1			22	2.88°	—	22.66	23.39	24.18	No Interference
HTNB 2015-260-1			26	2.50°	—	26.79	27.66	28.60	No Interference
HTNB 2015-300-1			30	2.20°	—	30.92	31.93	33.01	No Interference
HTNB 2015-360-1			36	1.87°	—	37.11	38.33	No Interference	No Interference
HTNB 2015-100-2		1°	10	5.46°	—	—	10.31	10.65	11.39
HTNB 2015-120-2			12	4.79°	—	—	12.38	12.78	13.69
HTNB 2015-160-2			16	3.83°	—	—	16.51	17.06	18.29
HTNB 2015-200-2			20	3.20°	—	—	20.65	21.34	22.89
HTNB 2015-260-2			26	2.56°	—	—	26.85	27.76	No Interference
HTNB 2015-300-2			30	2.26°	—	—	30.98	32.03	No Interference
HTNB 2015-360-2			36	1.92°	—	—	37.18	No Interference	No Interference
HTNB 2015-100-3			1°30'	10	5.57°	—	—	—	10.36
HTNB 2015-120-3		12		4.89°	—	—	—	12.43	13.31
HTNB 2015-160-3		16		3.92°	—	—	—	16.57	17.76
HTNB 2015-200-3		20		3.28°	—	—	—	20.71	22.21
HTNB 2015-260-3		26		2.63°	—	—	—	26.91	No Interference
HTNB 2015-300-3		30		2.32°	—	—	—	31.05	No Interference
HTNB 2015-360-3		36		1.98°	—	—	—	No Interference	No Interference
HTNB 2015-120-4		2°		12	4.98°	—	—	—	—
HTNB 2015-160-4			16	4.02°	—	—	—	—	17.20
HTNB 2015-200-4			20	3.36°	—	—	—	—	21.50
HTNB 2015-300-4			30	3.84°	—	—	—	—	32.25
HTNB 2015-120-6		3°	12	5.21°	—	—	—	—	—
HTNB 2015-160-6			16	4.22°	—	—	—	—	—
HTNB 2015-200-6			20	3.55°	—	—	—	—	—
HTNB 2015-300-6			30	4.04°	—	—	—	—	—

Next Page ➡

UDC Series

CBN Series

Square

Long Neck Square

Radius

Long Neck Radius

Taper Neck Radius

Ball / Long Shank Ball

Long Neck Ball

Taper Neck Ball

Taper

Spiral V Cutter

Drill

EURO Series

Technical Data

2 Flutes HARDMAX

Model Number	Radius of Ball Nose R	Neck Taper Angle TN	Neck Length ℓ_2	Effective Length ℓ_1	Length of Cut ℓ	Neck Diameter ϕd_1	Shank Taper Angle Bta	Overall Length L	Shank Diameter ϕd	Shape	Price ¥																
HTNB 2020-120-1	R1	30°	12	3	1.6	1.91	16°	60	4	B	8,100																
HTNB 2020-160-1			16					60	4		8,100																
HTNB 2020-200-1			20					60	4		8,640																
HTNB 2020-220-1			22					60	4		8,640																
HTNB 2020-240-1			24					60	4		9,600																
HTNB 2020-260-1			26					60	4		9,600																
HTNB 2020-280-1			28					70	4		10,560																
HTNB 2020-300-1			30					70	4		10,560																
HTNB 2020-320-1			32					70	4		10,560																
HTNB 2020-340-1			34					70	4		11,040																
HTNB 2020-360-1			36					80	4		11,040																
HTNB 2020-400-1			40					80	4		12,480																
HTNB 2020-100-2		1°	30°					10	3		1.6	1.91	16°	60	4	B	8,100										
HTNB 2020-120-2								12						60	4		8,100										
HTNB 2020-160-2								16						60	4		8,100										
HTNB 2020-200-2								20						60	4		8,640										
HTNB 2020-220-2								22						60	4		8,640										
HTNB 2020-240-2								24						60	4		9,600										
HTNB 2020-260-2								26						60	4		9,600										
HTNB 2020-280-2								28						70	4		10,560										
HTNB 2020-300-2								30						70	4		10,560										
HTNB 2020-320-2								32						70	4		10,560										
HTNB 2020-340-2								34						70	4		11,040										
HTNB 2020-360-2								36						80	4		11,040										
HTNB 2020-400-2			40					80						4	13,100												
※ HTNB 2020-100-3			1°30'					30°						10	3		1.6	1.91	16°	60	4	B	8,100				
※ HTNB 2020-120-3														12						60	4		8,100				
※ HTNB 2020-160-3														16						60	4		8,100				
※ HTNB 2020-200-3														20						60	4		8,640				
※ HTNB 2020-220-3														22						60	4		8,640				
※ HTNB 2020-240-3														24						60	4		9,600				
※ HTNB 2020-260-3														26						60	4		9,600				
※ HTNB 2020-280-3														28						70	4		10,560				
※ HTNB 2020-300-3														30						70	4		10,560				
※ HTNB 2020-320-3														32						70	4		10,560				
※ HTNB 2020-340-3														34						70	4		11,040				
※ HTNB 2020-360-3		36												80						4	11,040						
※ HTNB 2020-400-3		40	80					4						13,100													
※ HTNB 2020-120-4		2°	30°					12						3						1.6	1.91		16°	60	4	B	8,100
※ HTNB 2020-160-4								16																60	4		8,100
※ HTNB 2020-200-4	20			60	4	8,640																					
※ HTNB 2020-300-4	30			70	6	11,440																					
※ HTNB 2020-400-4	40		80	6	13,980																						
※ HTNB 2020-120-6	3°		30°	12	3	1.6	1.91	16°		60														4	B		8,100
※ HTNB 2020-160-6				16						60														4			8,100
※ HTNB 2020-200-6				20						60														4			8,640
※ HTNB 2020-300-6		30		70						6														11,440			
※ HTNB 2020-400-6	40	80	6	13,980																							

※Additional model

- UDC Series
- CBN Series
- Square
- Long Neck Square
- Radius
- Long Neck Radius
- Taper Neck Radius
- Ball / Long Shank Ball
- Long Neck Ball
- Taper Neck Ball
- Taper
- Spiral V Cutter
- Drill
- EURO Series
- Technical Data

Unit (mm)

Model Number	Radius of Ball Nose R	Neck Taper Angle TN	Neck Length ℓ_2	Interference Angle	Effective Length by Inclined Angles — : Interference					
					30°	1°	1°30'	2°	3°	
HTNB 2020-120-1	R1	30°	12	4.05°	—	12.34	12.72	13.14	14.05	
HTNB 2020-160-1			16	3.19°	—	16.47	16.99	17.55	18.80	
HTNB 2020-200-1			20	2.63°	—	20.60	21.26	21.97	No Interference	
HTNB 2020-220-1			22	2.42°	—	22.66	23.39	24.17	No Interference	
HTNB 2020-240-1			24	2.23°	—	24.73	25.53	26.38	No Interference	
HTNB 2020-260-1			26	2.08°	—	26.79	27.66	28.59	No Interference	
HTNB 2020-280-1			28	1.94°	—	28.86	29.80	No Interference	No Interference	
HTNB 2020-300-1			30	1.83°	—	30.92	31.93	No Interference	No Interference	
HTNB 2020-320-1			32	1.72°	—	32.99	34.07	No Interference	No Interference	
HTNB 2020-340-1			34	1.63°	—	35.05	36.20	No Interference	No Interference	
HTNB 2020-360-1			36	1.54°	—	37.12	38.33	No Interference	No Interference	
HTNB 2020-400-1			40	1.40°	—	41.25	No Interference	No Interference	No Interference	
HTNB 2020-100-2			1°	1°	10	4.77°	—	—	10.34	10.66
HTNB 2020-120-2		12			4.13°	—	—	12.40	12.80	13.69
HTNB 2020-160-2		16			3.26°	—	—	16.53	17.08	18.29
HTNB 2020-200-2		20			2.69°	—	—	20.67	21.35	No Interference
HTNB 2020-220-2		22			2.48°	—	—	22.73	23.49	No Interference
HTNB 2020-240-2		24			2.29°	—	—	24.80	25.63	No Interference
HTNB 2020-260-2		26			2.13°	—	—	26.87	27.77	No Interference
HTNB 2020-280-2		28			2.00°	—	—	28.94	29.91	No Interference
HTNB 2020-300-2		30			1.88°	—	—	31.00	No Interference	No Interference
HTNB 2020-320-2		32			1.77°	—	—	33.07	No Interference	No Interference
HTNB 2020-340-2		34			1.67°	—	—	35.14	No Interference	No Interference
HTNB 2020-360-2		36			1.59°	—	—	37.20	No Interference	No Interference
HTNB 2020-400-2		40			1.44°	—	—	No Interference	No Interference	No Interference
HTNB 2020-100-3		1°30'	1°30'	10	4.83°	—	—	10.38	11.09	
HTNB 2020-120-3				12	4.22°	—	—	—	12.46	13.33
HTNB 2020-160-3				16	3.34°	—	—	—	16.60	17.78
HTNB 2020-200-3				20	2.76°	—	—	—	20.74	No Interference
HTNB 2020-220-3				22	2.54°	—	—	—	22.81	No Interference
HTNB 2020-240-3				24	2.35°	—	—	—	24.88	No Interference
HTNB 2020-260-3				26	2.19°	—	—	—	26.95	No Interference
HTNB 2020-280-3				28	2.05°	—	—	—	29.02	No Interference
HTNB 2020-300-3				30	1.93°	—	—	—	No Interference	No Interference
HTNB 2020-320-3				32	1.82°	—	—	—	No Interference	No Interference
HTNB 2020-340-3				34	1.72°	—	—	—	No Interference	No Interference
HTNB 2020-360-3				36	1.63°	—	—	—	No Interference	No Interference
HTNB 2020-400-3				40	1.48°	—	—	—	No Interference	No Interference
HTNB 2020-120-4		2°	2°	12	4.29°	—	—	—	12.97	
HTNB 2020-160-4				16	3.41°	—	—	—	—	17.26
HTNB 2020-200-4	20			2.83°	—	—	—	—	No Interference	
HTNB 2020-300-4	30			3.52°	—	—	—	—	32.31	
HTNB 2020-400-4	40			2.78°	—	—	—	—	No Interference	
HTNB 2020-120-6	3°	3°	12	4.48°	—	—	—	—		
HTNB 2020-160-6			16	3.58°	—	—	—	—	—	
HTNB 2020-200-6			20	2.98°	—	—	—	—	—	
HTNB 2020-300-6			30	3.71°	—	—	—	—	—	
HTNB 2020-400-6			40	2.94°	—	—	—	—	—	

UDC Series

CBN Series

Square

Square

Long Neck Square

Radius

Radius

Long Neck Radius

Taper Neck Radius

Ball / Long Shank Ball

Ball

Long Neck Ball

Taper Neck Ball

Taper

Spiral V Cutter

Drill

EURO Series

Technical Data

2 Flutes HARDMAX

Model Number	Radius of Ball Nose R	Neck Taper Angle TN	Neck Length ℓ_2	Effective Length ℓ_1	Length of Cut ℓ	Neck Diameter ϕd_1	Shank Taper Angle Bta	Overall Length L	Shank Diameter ϕd	Shape	Price ¥							
HTNB 2030-200-1	R1.5	30°	20	4.5	2.4	2.89	16°	60	6	B	9,740							
HTNB 2030-220-1			22					60	6		9,740							
HTNB 2030-260-1			26					70	6		10,400							
HTNB 2030-300-1			30					70	6		11,880							
HTNB 2030-320-1			32					70	6		12,480							
HTNB 2030-360-1			36					80	6		13,000							
HTNB 2030-400-1			40					80	6		13,200							
HTNB 2030-420-1			42					90	6		13,680							
HTNB 2030-520-1			52					100	6		15,360							
HTNB 2030-200-2			20					60	6		9,740							
HTNB 2030-260-2		26	70					6	10,400									
HTNB 2030-300-2		30	70					6	11,880									
HTNB 2030-320-2		32	70					6	12,480									
HTNB 2030-360-2		36	80					6	13,000									
HTNB 2030-400-2		40	80					6	13,200									
HTNB 2030-420-2		42	90					6	13,680									
HTNB 2030-480-2		48	100					6	15,360									
HTNB 2030-520-2		52	100					6	15,360									
HTNB 2030-620-2		62	100					6	18,230									
HTNB 2030-200-3		1°	1°30'					20	6		3.2	3.87	16°	60	6	B	9,740	
HTNB 2030-260-3	26			70	6	10,400												
HTNB 2030-300-3	30			70	6	11,880												
HTNB 2030-320-3	32			70	6	12,480												
HTNB 2030-360-3	36			80	6	13,000												
HTNB 2030-400-3	40			80	6	13,200												
HTNB 2030-420-3	42			90	6	13,680												
HTNB 2030-580-3	58			100	6	15,360												
HTNB 2040-300-1	R2			30°	30	6	3.2	3.87		16°				80	6		B	11,590
HTNB 2040-400-1					40									80	6			15,000
HTNB 2040-620-1		62	120		6				19,200									
HTNB 2040-200-2		20	80		6				11,590									
HTNB 2040-300-2		30	80		6				11,590									
HTNB 2040-360-2		36	80	6	13,420													
HTNB 2040-400-2		40	80	6	15,000													
HTNB 2040-600-2		60	120	6	19,200													
HTNB 2040-410-3		41	80	6	15,000													
※ HTNB 2040-600-3		1°30'	60	120	8				28,000									
HTNB 2040-800-3	80		130	8	C	30,360												

※Additional model

UDC Series

CBN Series

Square
Long Neck Square

Radius
Long Neck Radius
Taper Neck Radius

Ball / Long Shank Ball
Long Neck Ball
Taper Neck Ball

Taper

Spiral V Cutter

Drill

EURO Series

Technical Data

※

Unit (mm)

Model Number	Radius of Ball Nose R	Neck Taper Angle TN	Neck Length ℓ_2	Interference Angle	Effective Length by Inclined Angles — : Interference						
					30°	1°	1°30'	2°	3°		
HTNB 2030-200-1	R1.5	30°	20	3.71°	—	20.59	21.23	21.92	23.46		
HTNB 2030-220-1			22	3.43°	—	22.65	23.36	24.13	25.83		
HTNB 2030-260-1			26	2.97°	—	26.78	27.63	28.54	No Interference		
HTNB 2030-300-1			30	2.62°	—	30.91	31.90	32.96	No Interference		
HTNB 2030-320-1			32	2.48°	—	32.98	34.04	35.17	No Interference		
HTNB 2030-360-1			36	2.23°	—	37.11	38.30	39.58	No Interference		
HTNB 2030-400-1			40	2.03°	—	41.23	42.57	44.00	No Interference		
HTNB 2030-420-1			42	1.94°	—	43.30	44.70	No Interference	No Interference		
HTNB 2030-520-1			52	1.60°	—	53.62	55.38	No Interference	No Interference		
HTNB 2030-200-2			1°	30°	20	3.79°	—	—	20.66	21.33	22.83
HTNB 2030-260-2		26			3.04°	—	—	26.87	27.75	29.72	
HTNB 2030-300-2		30			2.69°	—	—	31.00	32.03	No Interference	
HTNB 2030-320-2		32			2.54°	—	—	33.07	34.17	No Interference	
HTNB 2030-360-2		36			2.29°	—	—	37.20	38.44	No Interference	
HTNB 2030-400-2		40			2.08°	—	—	41.33	42.72	No Interference	
HTNB 2030-420-2		42			1.99°	—	—	43.40	No Interference	No Interference	
HTNB 2030-480-2		48			1.77°	—	—	49.60	No Interference	No Interference	
HTNB 2030-520-2		52			1.64°	—	—	53.74	No Interference	No Interference	
HTNB 2030-620-2		62			1.39°	—	—	No Interference	No Interference	No Interference	
HTNB 2030-200-3		1°30'	30°	20	3.88°	—	—	—	20.75	22.20	
HTNB 2030-260-3				26	3.12°	—	—	—	26.96	28.87	
HTNB 2030-300-3				30	2.76°	—	—	—	31.09	No Interference	
HTNB 2030-320-3				32	2.61°	—	—	—	33.16	No Interference	
HTNB 2030-360-3				36	2.35°	—	—	—	37.30	No Interference	
HTNB 2030-400-3				40	2.14°	—	—	—	41.44	No Interference	
HTNB 2030-420-3				42	2.05°	—	—	—	43.51	No Interference	
HTNB 2030-580-3				58	1.53°	—	—	—	No Interference	No Interference	
HTNB 2040-300-1				R2	30°	30	1.88°	—	30.91	31.88	No Interference
HTNB 2040-400-1	40					1.43°	—	41.23	No Interference	No Interference	No Interference
HTNB 2040-620-1	62	0.94°	—			No Interference	No Interference	No Interference	No Interference		
HTNB 2040-200-2	1°	30°	20		2.81°	—	—	20.67	21.32	No Interference	
HTNB 2040-300-2			30		1.93°	—	—	31.00	No Interference	No Interference	
HTNB 2040-360-2			36		1.63°	—	—	37.21	No Interference	No Interference	
HTNB 2040-400-2			40		1.47°	—	—	No Interference	No Interference	No Interference	
HTNB 2040-600-2			60		1.00°	—	—	No Interference	No Interference	No Interference	
HTNB 2040-410-3			1°30'		30°	41	1.48°	—	—	—	No Interference
HTNB 2040-600-3	60	1.92°				—	—	—	No Interference	No Interference	
HTNB 2040-800-3	80	—				—	—	—	No Interference	No Interference	

UDC Series

CBN Series

Square

Square
Long Neck Square

Radius

Radius
Long Neck Radius

Taper Neck Radius

Ball / Long Shank Ball

Ball
Long Neck Ball

Taper Neck Ball

Taper

Spiral V Cutter

Drill

EURO Series

Technical Data

Milling Conditions for HTNB

WORK MATERIAL			COPPER / CARBON STEELS Cu / S45C / S50C					PREHARDENED STEELS / HARDENED STEELS NAK / SKD (30~45HRC)					
Model Number	Radius of Ball Nose (mm)	Neck Length (mm)	Spindle Speed (min ⁻¹)	Feed Rate (mm/min)	a _p Axial Depth (mm)	a _e Radial Depth		Spindle Speed (min ⁻¹)	Feed Rate (mm/min)	a _p Axial Depth (mm)	a _e Radial Depth		
						Roughing (mm)	Finishing (mm)				Roughing (mm)	Finishing (mm)	
UDC Series	2002	R0.1	1.5	42,000	640	0.008	0.02	0.015	29,000	430	0.006	0.02	0.015
			2	33,000	370	0.006	0.02	0.011	23,500	260	0.005	0.02	0.011
			3	27,000	270	0.002	0.02	0.01	19,000	165	0.001	0.02	0.009
CBN Series	2003	R0.15	2	36,000	650	0.009	0.03	0.018	25,200	400	0.007	0.03	0.016
			3	33,000	500	0.004	0.03	0.015	23,000	330	0.003	0.03	0.014
Square	2004	R0.2	3	42,000	1,300	0.018	0.04	0.031	29,000	800	0.014	0.04	0.028
			4	33,000	800	0.008	0.04	0.024	23,000	520	0.006	0.04	0.023
			6	27,000	550	0.005	0.04	0.02	19,000	330	0.004	0.04	0.017
Long Neck Square	2005	R0.25	4	36,000	1,330	0.02	0.05	0.037	28,000	870	0.016	0.05	0.031
			6	29,000	900	0.012	0.05	0.031	23,000	650	0.009	0.05	0.028
			8	23,500	600	0.007	0.05	0.026	19,000	450	0.006	0.05	0.024
			10	20,000	480	0.004	0.05	0.024	18,000	380	0.003	0.05	0.021
Radius	2006	R0.3	4	44,000	2,340	0.032	0.06	0.053	32,500	1,500	0.025	0.06	0.046
			6	36,000	1,500	0.018	0.06	0.042	29,000	1,100	0.014	0.06	0.038
			8	28,500	1,150	0.018	0.06	0.04	24,000	770	0.014	0.06	0.032
			10	28,500	950	0.014	0.06	0.033	24,000	720	0.011	0.06	0.03
			12	28,500	950	0.009	0.06	0.033	24,000	720	0.007	0.06	0.03
			14	26,500	800	0.007	0.06	0.03	23,000	660	0.005	0.06	0.029
			16	25,000	700	0.005	0.06	0.028	22,000	600	0.004	0.06	0.027
			20	20,000	400	0.003	0.06	0.02	17,000	330	0.002	0.06	0.019
Long Neck Radius	2008	R0.4	6	36,000	2,000	0.023	0.08	0.056	24,000	1,300	0.019	0.08	0.054
			8	28,500	1,500	0.023	0.08	0.053	20,000	950	0.019	0.08	0.048
			12	28,500	1,200	0.018	0.08	0.042	16,500	600	0.014	0.08	0.036
			16	25,000	900	0.01	0.08	0.036	15,000	500	0.008	0.08	0.033
Taper Neck Radius	2010	R0.5	6	35,000	2,900	0.05	0.1	0.083	23,000	1,850	0.04	0.1	0.08
			8	28,000	2,200	0.05	0.1	0.079	19,000	1,500	0.04	0.1	0.079
			10	24,000	1,800	0.035	0.1	0.075	17,000	1,300	0.03	0.1	0.076
			12	19,000	1,360	0.027	0.1	0.072	14,000	1,000	0.022	0.1	0.071
			14	18,000	1,200	0.025	0.1	0.067	13,000	900	0.02	0.1	0.069
			16	18,000	1,150	0.025	0.1	0.064	13,000	850	0.02	0.1	0.065
			18	17,500	1,120	0.018	0.1	0.064	12,500	800	0.013	0.1	0.064
			20	17,000	1,080	0.016	0.1	0.064	12,000	780	0.013	0.1	0.064
			22	17,000	1,080	0.016	0.1	0.064	12,000	780	0.013	0.1	0.064
			26	16,000	1,000	0.015	0.1	0.063	11,000	700	0.012	0.1	0.064
			29.8	13,400	840	0.012	0.1	0.063	10,000	620	0.01	0.1	0.062
			30	13,400	840	0.012	0.1	0.063	10,000	620	0.01	0.1	0.062
			32	12,000	750	0.011	0.1	0.063	9,000	550	0.009	0.1	0.061
36	10,000	620	0.009	0.1	0.062	7,000	420	0.007	0.1	0.06			
Ball / Long Shark Ball	2015	R0.75	10	20,000	2,300	0.065	0.15	0.115	13,000	1,600	0.05	0.15	0.123
			12	18,000	2,000	0.055	0.15	0.111	13,000	1,500	0.045	0.15	0.115
			16	16,000	1,600	0.05	0.15	0.1	12,000	1,200	0.03	0.15	0.1
			20	14,000	1,400	0.035	0.15	0.1	10,000	950	0.025	0.15	0.095
			22	14,000	1,400	0.035	0.15	0.1	10,000	950	0.025	0.15	0.095
			26	12,000	1,200	0.025	0.15	0.1	10,000	900	0.02	0.15	0.09
			30	10,000	950	0.02	0.15	0.095	8,000	700	0.015	0.15	0.088
			36	10,000	950	0.02	0.15	0.095	7,000	600	0.015	0.15	0.086

Milling Conditions for HTNB

WORK MATERIAL			HARDENED STEELS SKD / SKT (45~55HRC)					HARDENED STEELS SKD / SKS (55~65HRC)				
Model Number	Radius of Ball Nose (mm)	Neck Length (mm)	Spindle Speed (min ⁻¹)	Feed Rate (mm/min)	a_p Axial Depth (mm)	a_e Radial Depth		Spindle Speed (min ⁻¹)	Feed Rate (mm/min)	a_p Axial Depth (mm)	a_e Radial Depth	
						Roughing (mm)	Finishing (mm)				Roughing (mm)	Finishing (mm)
2002	R0.1	1.5	28,000	330	0.006	0.016	0.012	28,000	260	0.005	0.012	0.009
		2	22,000	210	0.004	0.016	0.01	22,000	190	0.004	0.012	0.009
		3	17,500	150	0.001	0.016	0.009	17,500	130	0.001	0.012	0.007
2003	R0.15	2	23,500	350	0.006	0.024	0.015	23,500	300	0.005	0.018	0.013
		3	21,500	250	0.003	0.024	0.012	21,500	200	0.002	0.018	0.009
2004	R0.2	3	27,000	670	0.012	0.032	0.025	27,000	500	0.01	0.024	0.019
		4	22,000	430	0.006	0.032	0.02	22,000	380	0.005	0.024	0.017
		6	18,000	300	0.004	0.032	0.017	18,000	260	0.003	0.024	0.014
2005	R0.25	4	27,500	650	0.014	0.04	0.024	27,500	625	0.011	0.03	0.023
		6	22,000	530	0.008	0.04	0.024	22,000	500	0.007	0.03	0.023
		8	17,000	380	0.005	0.04	0.022	17,000	350	0.004	0.03	0.021
		10	16,000	330	0.002	0.04	0.021	16,000	300	0.002	0.03	0.019
2006	R0.3	4	25,500	850	0.022	0.048	0.033	25,500	713	0.018	0.036	0.028
		6	21,000	700	0.012	0.048	0.033	21,000	550	0.01	0.036	0.026
		8	17,000	510	0.012	0.048	0.03	17,000	425	0.01	0.036	0.025
		10	17,000	470	0.009	0.048	0.028	16,000	390	0.008	0.036	0.024
		12	16,000	400	0.006	0.048	0.025	15,000	350	0.005	0.036	0.023
		14	15,500	370	0.004	0.048	0.024	14,500	320	0.004	0.036	0.022
		16	15,000	350	0.003	0.048	0.023	14,500	300	0.003	0.036	0.021
2008	R0.4	6	21,000	900	0.016	0.064	0.043	21,000	800	0.013	0.048	0.038
		8	17,000	680	0.016	0.064	0.04	17,000	600	0.013	0.048	0.035
		12	14,000	480	0.012	0.064	0.034	14,000	420	0.01	0.048	0.03
		16	13,000	420	0.006	0.064	0.032	12,500	350	0.006	0.048	0.028
2010	R0.5	6	23,000	1,500	0.034	0.08	0.065	22,000	1,200	0.028	0.06	0.055
		8	19,000	1,130	0.034	0.08	0.059	18,000	920	0.028	0.06	0.051
		10	16,000	950	0.027	0.08	0.059	15,500	770	0.022	0.06	0.05
		12	12,600	760	0.019	0.08	0.06	12,600	615	0.015	0.06	0.049
		14	12,000	700	0.017	0.08	0.058	12,000	540	0.014	0.06	0.045
		16	12,000	700	0.017	0.08	0.058	12,000	540	0.014	0.06	0.045
		18	11,000	640	0.011	0.08	0.058	11,000	490	0.01	0.06	0.045
		20	11,000	640	0.011	0.08	0.058	11,000	490	0.009	0.06	0.045
		22	11,000	640	0.011	0.08	0.058	11,000	490	0.009	0.06	0.045
		26	10,000	570	0.01	0.08	0.057	10,000	460	0.009	0.06	0.046
		29.8	9,500	530	0.009	0.08	0.055	9,500	410	0.008	0.06	0.043
		30	9,500	530	0.009	0.08	0.055	9,500	410	0.008	0.06	0.043
2015	R0.75	32	9,000	490	0.008	0.08	0.054	9,000	380	0.007	0.06	0.042
		36	7,000	380	0.006	0.08	0.054	7,000	280	0.005	0.06	0.04
		10	13,000	1,200	0.04	0.12	0.092	13,000	950	0.035	0.09	0.073
		12	11,000	950	0.035	0.12	0.086	11,000	750	0.03	0.09	0.068
		16	11,000	900	0.03	0.12	0.082	11,000	750	0.025	0.09	0.068
		20	10,000	800	0.02	0.12	0.08	10,000	650	0.018	0.09	0.065
		22	10,000	800	0.02	0.12	0.08	10,000	650	0.018	0.09	0.065
		26	9,000	700	0.017	0.12	0.078	9,000	600	0.015	0.09	0.067
30	8,000	600	0.013	0.12	0.075	8,000	500	0.013	0.09	0.063		
36	7,000	500	0.013	0.12	0.071	7,000	400	0.013	0.09	0.057		

UDC Series

CBN Series

Square

Square

Long Neck Square

Radius

Radius

Long Neck Radius

Taper Neck Radius

Ball / Long Shank Ball

Ball

Long Neck Ball

Taper Neck Ball

Taper

Taper

Spiral V Cutter

Drill

EURO Series

Technical Data

Milling Conditions for HTNB

WORK MATERIAL			COPPER / CARBON STEELS Cu / S45C / S50C					PREHARDENED STEELS / HARDENED STEELS NAK / SKD (30~45HRC)				
Model Number	Radius of Ball Nose (mm)	Neck Length (mm)	Spindle Speed (min ⁻¹)	Feed Rate (mm/min)	a _p Axial Depth (mm)	a _e Radial Depth		Spindle Speed (min ⁻¹)	Feed Rate (mm/min)	a _p Axial Depth (mm)	a _e Radial Depth	
						Roughing (mm)	Finishing (mm)				Roughing (mm)	Finishing (mm)
2020	R1	10	19,000	3,300	0.11	0.2	0.174	12,000	2,100	0.1	0.2	0.175
		12	17,000	2,900	0.09	0.2	0.171	12,000	2,000	0.095	0.2	0.167
		16	15,000	2,350	0.081	0.2	0.157	11,000	1,700	0.065	0.2	0.155
		20	11,000	1,600	0.068	0.2	0.145	8,400	1,100	0.055	0.2	0.131
		22	11,000	1,600	0.063	0.2	0.145	8,400	1,050	0.05	0.2	0.125
		24	11,000	1,500	0.063	0.2	0.136	8,400	1,050	0.05	0.2	0.125
		26	10,000	1,350	0.063	0.2	0.135	7,350	900	0.05	0.2	0.122
		28	10,000	1,350	0.05	0.2	0.135	7,350	870	0.038	0.2	0.118
		30	10,000	1,350	0.05	0.2	0.135	7,350	870	0.038	0.2	0.118
		32	10,000	1,350	0.041	0.2	0.135	7,350	850	0.032	0.2	0.116
		34	10,000	1,350	0.041	0.2	0.135	7,000	800	0.032	0.2	0.114
		36	10,000	1,350	0.041	0.2	0.135	7,000	800	0.032	0.2	0.114
40	10,000	1,350	0.041	0.2	0.135	7,000	800	0.032	0.2	0.114		
2030	R1.5	20	11,000	2,350	0.095	0.3	0.214	8,400	1,500	0.075	0.3	0.179
		22	11,000	2,350	0.09	0.3	0.214	8,400	1,500	0.071	0.3	0.179
		26	10,000	2,050	0.085	0.3	0.205	7,600	1,300	0.068	0.3	0.171
		30	10,000	2,000	0.081	0.3	0.2	7,500	1,250	0.065	0.3	0.167
		32	10,000	1,900	0.081	0.3	0.19	7,500	1,200	0.065	0.3	0.16
		36	9,000	1,700	0.073	0.3	0.189	6,000	950	0.058	0.3	0.158
		40	8,500	1,600	0.065	0.3	0.188	6,000	950	0.053	0.3	0.158
		42	8,500	1,600	0.063	0.3	0.188	6,000	950	0.05	0.3	0.158
		48	8,500	1,570	0.052	0.3	0.185	6,000	920	0.042	0.3	0.153
		52	8,500	1,550	0.045	0.3	0.182	6,000	900	0.036	0.3	0.15
62	5,600	930	0.035	0.3	0.166	5,000	700	0.025	0.3	0.14		
2040	R2	20	8,400	1,900	0.125	0.4	0.226	5,400	1,030	0.096	0.4	0.191
		30	7,600	1,600	0.1	0.4	0.211	4,800	850	0.083	0.4	0.177
		36	6,900	1,400	0.094	0.4	0.203	3,900	650	0.074	0.4	0.167
		40	6,500	1,300	0.086	0.4	0.2	3,900	650	0.068	0.4	0.167
		41	6,500	1,300	0.086	0.4	0.2	3,900	650	0.068	0.4	0.167
		60	4,300	780	0.063	0.4	0.181	3,300	500	0.05	0.4	0.152
		62	4,300	750	0.063	0.4	0.174	3,300	480	0.05	0.4	0.145
		80	4,300	750	0.063	0.4	0.174	3,300	480	0.05	0.4	0.145
Radial Depth (mm)	Roughing	$a_e \leq 0.1D$					$a_e \leq 0.1D$					
	Finishing	$a_e \leq V_f / n$										

a_p : Axial Depth (mm)
a_e : Radial Depth (mm)
D : Outside Diameter (mm)

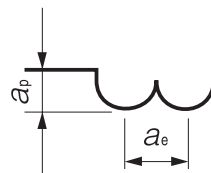

Milling Conditions for HTNB

WORK MATERIAL			HARDENED STEELS SKD / SKT (45~55HRC)					HARDENED STEELS SKD / SKS (55~65HRC)				
Model Number	Radius of Ball Nose (mm)	Neck Length (mm)	Spindle Speed (min ⁻¹)	Feed Rate (mm/min)	a_p Axial Depth (mm)	a_e Radial Depth		Spindle Speed (min ⁻¹)	Feed Rate (mm/min)	a_p Axial Depth (mm)	a_e Radial Depth	
						Roughing (mm)	Finishing (mm)				Roughing (mm)	Finishing (mm)
2020	R1	10	12,000	1,800	0.074	0.16	0.15	12,000	1,350	0.064	0.12	0.113
		12	10,500	1,430	0.065	0.16	0.136	10,500	1,070	0.055	0.12	0.102
		16	10,500	1,360	0.056	0.16	0.13	10,500	1,070	0.046	0.12	0.102
		20	9,450	1,150	0.048	0.16	0.122	9,450	920	0.038	0.12	0.097
		22	9,450	1,150	0.043	0.16	0.122	9,450	920	0.036	0.12	0.097
		24	8,400	1,020	0.043	0.16	0.121	8,400	800	0.036	0.12	0.095
		26	8,400	1,020	0.043	0.16	0.121	8,400	800	0.036	0.12	0.095
		28	7,350	850	0.033	0.16	0.116	7,350	690	0.028	0.12	0.094
		30	7,350	850	0.033	0.16	0.116	7,350	690	0.028	0.12	0.094
		32	7,350	850	0.028	0.16	0.116	7,350	690	0.023	0.12	0.094
		34	6,500	745	0.028	0.16	0.115	6,500	610	0.023	0.12	0.094
		36	6,500	745	0.028	0.16	0.115	6,500	610	0.023	0.12	0.094
40	6,500	745	0.028	0.16	0.115	6,500	610	0.023	0.12	0.094		
2030	R1.5	20	8,000	1,400	0.065	0.24	0.175	8,000	1,200	0.053	0.18	0.15
		22	8,000	1,400	0.062	0.24	0.175	8,000	1,200	0.05	0.18	0.15
		26	7,500	1,200	0.06	0.24	0.16	7,500	1,050	0.048	0.18	0.14
		30	7,000	1,100	0.057	0.24	0.157	7,000	980	0.047	0.18	0.14
		32	7,000	1,100	0.056	0.24	0.157	7,000	950	0.046	0.18	0.136
		36	6,000	950	0.05	0.24	0.158	6,000	800	0.042	0.18	0.133
		40	5,500	850	0.045	0.24	0.155	5,500	750	0.038	0.18	0.136
		42	5,500	850	0.043	0.24	0.155	5,500	750	0.036	0.18	0.136
		48	5,500	820	0.035	0.24	0.149	5,500	720	0.03	0.18	0.131
		52	5,500	800	0.031	0.24	0.145	5,500	700	0.026	0.18	0.127
62	4,700	600	0.023	0.24	0.128	4,700	530	0.021	0.18	0.113		
2040	R2	20	5,200	980	0.085	0.32	0.188	5,200	840	0.066	0.24	0.162
		30	4,500	770	0.074	0.32	0.171	4,500	690	0.059	0.24	0.153
		36	3,900	670	0.065	0.32	0.172	3,900	560	0.052	0.24	0.144
		40	3,600	600	0.059	0.32	0.167	3,600	530	0.048	0.24	0.147
		41	3,600	600	0.059	0.32	0.167	3,600	530	0.048	0.24	0.147
		60	3,100	450	0.043	0.32	0.145	3,100	400	0.036	0.24	0.129
		62	3,100	420	0.043	0.32	0.135	3,100	380	0.036	0.24	0.123
		80	2,900	340	0.035	0.32	0.117	2,500	200	0.02	0.24	0.08
Radial Depth (mm)		Roughing	$a_e \leq 0.08D$					$a_e \leq 0.06D$				
		Finishing	$a_e \leq V_f / n$									

Note:

- Decrease both spindle speed and feed rate proportionally when the milling parameters exceed the machine's maximum spindle speed.
- The neck length and taper angle may affect the milling parameters. In operation, fine adjustments may be required.
- Recommend air blow or oil mist.
- Recommend oil coolant for Stainless Steels and Heat Resistant Alloys.
- Recommend water soluble or oil base coolant for Copper.

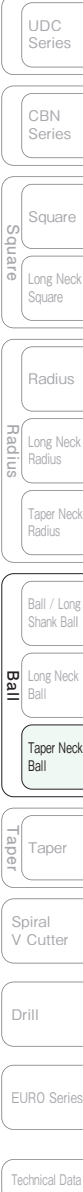



Size R0.5~R1

DCTNB

MG DIA 35° R ±0.01 Shank Dia 0/-0.005

Material Applications (☆ Highly Recommended ● Recommended ○ Suggested)

Work Material															
Carbon Steels S45C S55C	Alloy Steels SK / SCM SUS	Prehardened Steels NAK HPM	Hardened Steels			Cast Iron	Aluminum Alloys	Graphite	Copper	Plastics	Glass Filled Plastics	Titanium Alloys	Heat Resistant Alloys	Cemented Carbide	Hard Brittle (Non-Metallic) Materials
			~55HRC	~60HRC	~70HRC										
							○	☆	○	○	●				○

Features

2 Flute Diamond coated Taper Neck Ball End Mills for Graphite Electrodes.
Taper Neck design improves the tool rigidity and provides high-efficiency & high-precision milling.
Original and optimized Diamond coating offers outstanding resistance to wear on Graphite.
Excellent adhesion coating with long-life tool design.

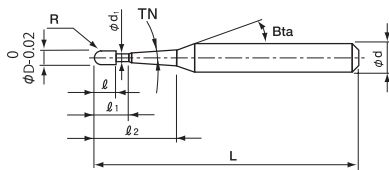
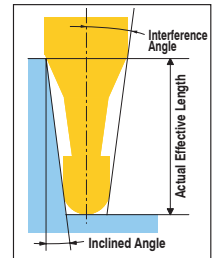

The shank taper angle shown is not an exact value and to avoid contact with the work piece, we recommend the user controls the precise value of this angle. Shank taper angle should not make contact with the work piece.

Total 15 models

Unit (mm)

Model Number	Radius of Ball Nose R	Neck Taper Angle TN	Neck Length ℓ ₂	Effective Length ℓ ₁	Length of Cut ℓ	Neck Diameter φ _{d1}	Shank Taper Angle Bta	Overall Length L	Shank Diameter φ _d	Price ¥	Interference Angle	Effective Length by Inclined Angles - : Interference				
												30'	1°	1°30'	2°	3°
DCTNB 2010-200-1.8	R0.5	0.9°	20	4	0.8	0.96	16°	80	6	18,730	5.25°	-	20.24	20.90	21.61	23.20
DCTNB 2010-250-1.8			25					80	6	21,850	4.48°	-	25.27	26.10	26.99	28.98
DCTNB 2010-400-1.8			40					100	6	25,470	3.11°	-	40.36	41.70	43.13	46.32
DCTNB 2010-600-1.8			60					120	6	33,220	2.21°	-	60.49	62.50	64.65	No Interference
DCTNB 2010-700-1.8			70					120	6	33,220	1.93°	-	70.55	72.90	No Interference	No Interference
DCTNB 2010-800-1.8			80					140	6	33,490	1.72°	-	80.62	83.30	No Interference	No Interference
DCTNB 2010-900-1.8			90					150	6	35,230	1.54°	-	90.68	93.71	No Interference	No Interference
DCTNB 2020-200-1.8	R1	0.9°	20	7	1.6	1.9	16°	80	6	18,730	4.55°	-	20.34	21.00	21.69	23.25
DCTNB 2020-250-1.8			25					80	6	21,850	3.84°	-	25.38	26.20	27.08	29.03
DCTNB 2020-400-1.8			40					100	6	25,470	2.61°	-	40.47	41.80	43.22	No Interference
DCTNB 2020-450-1.8			45					100	6	25,470	2.36°	-	45.51	47.00	48.60	No Interference
DCTNB 2020-600-1.8			60					120	6	33,220	1.83°	-	60.59	62.59	No Interference	No Interference
DCTNB 2020-700-1.8			70					120	6	33,220	1.59°	-	70.66	73.00	No Interference	No Interference
DCTNB 2020-800-1.8			80					140	6	33,490	1.41°	-	80.72	No Interference	No Interference	No Interference
DCTNB 2020-1000-1.8			100					150	6	37,910	1.15°	-	100.85	No Interference	No Interference	No Interference

Milling Conditions for DCTNB

WORK MATERIAL			GRAPHITE			
Model Number	Radius of Ball Nose (mm)	Neck Length (mm)	Spindle Speed (min ⁻¹)	Feed Rate (mm/min)	a_p Axial Depth (mm)	a_e Radial Depth (mm)
2010-200-1.8	R0.5	20	30,000	1,500	0.1	0.12
2010-250-1.8		25	30,000	1,500	0.08	0.12
2010-400-1.8		40	27,000	1,200	0.07	0.12
2010-600-1.8		60	23,000	800	0.06	0.12
2010-700-1.8		70	20,000	600	0.05	0.12
2010-800-1.8		80	18,000	500	0.04	0.12
2010-900-1.8		90	15,000	400	0.03	0.12
2020-200-1.8		R1	20	27,000	2,000	0.24
2020-250-1.8	25		27,000	2,000	0.19	0.5
2020-400-1.8	40		27,000	2,000	0.13	0.4
2020-450-1.8	45		27,000	2,000	0.11	0.4
2020-600-1.8	60		23,000	1,500	0.1	0.3
2020-700-1.8	70		20,000	1,200	0.09	0.3
2020-800-1.8	80		17,000	900	0.09	0.2
2020-10001.8	100		14,000	600	0.09	0.2

Note:

- Use a milling machine dedicated for Graphite.
- Decrease the feed rate more than 50% from the milling parameters when slot milling.
- Recommend air blow for Graphite.

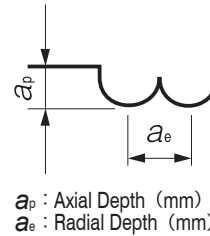

UDC Series

CBN Series

Square
Long Neck SquareRadius
Long Neck Radius

Taper Neck Radius

Ball / Long Shank Ball

Long Neck Ball

Taper Neck Ball

Taper

Spiral V Cutter

Drill

EURO Series

Technical Data



Size R0.5~R2

HFTNB



Additional 2 models

Material Applications (☆ Highly Recommended ○ Recommended ○ Suggested)

Work Material															
Carbon Steels	Alloy Steels	Prehardened Steels	Hardened Steels			Cast Iron	Aluminum Alloys	Graphite	Copper	Plastics	Glass Filled Plastics	Titanium Alloys	Heat Resistant Alloys	Cemented Carbide	Hard Brittle (Non-Metallic) Materials
S45C S55C	SK / SCM SUS	NAK HPM	~55HRC	~60HRC	~70HRC										
○	○	○	○	○	○	○						○	○		

Features

3 Flute Taper Neck Ball End Mills for Hard Materials.
 The negative rake angle design improves wear resistance.
 Back taper design reduces cutting resistance.
 Suitable for both roughing and finishing. Diameter Tolerance : 0/-0.015.

Shape A

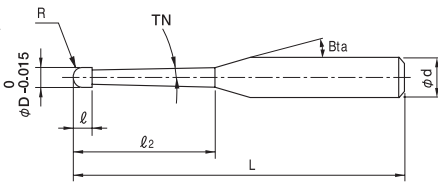

Shape B

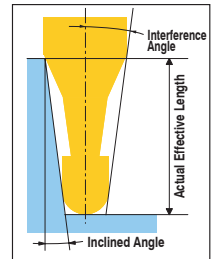
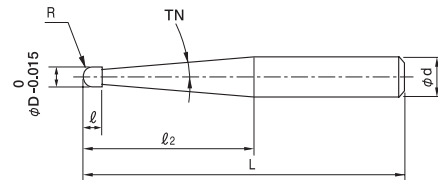

The shank taper angle shown is not an exact value and to avoid contact with the work piece, we recommend the user controls the precise value of this angle. Shank taper angle should not make contact with the work piece.

- **Variable Pitch design**
Minimizing vibration and chattering

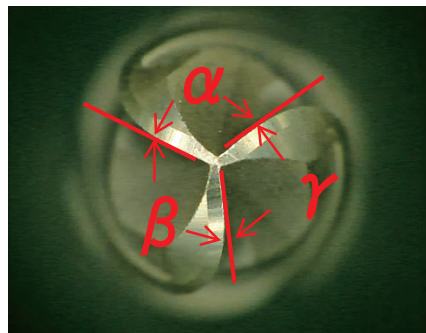

※Variable Pitch $\alpha \neq \beta \neq \gamma$

- **A wide choice of Taper Neck Angles**
 Useful sizes: 0.4° · 0.9° · 1.4° · 1.9° · 2.9°
 Using with HTNRS, Taper Neck Radius End Mill, offers higher efficient milling.
 Refer to page 386 for HTNRS.

Total 75 models

Unit (mm)

Model Number	Radius of Ball Nose R	Neck Taper Angle TN	Neck Length ℓ_2	Length of Cut ℓ	Shank Taper Angle Bta	Overall Length L	Shank Diameter ϕd	Shape	Price ¥	Interference Angle	Effective Length by Inclined Angles — : Interference					
											30'	1°	1°30'	2°	3°	
											HFTNB 3010-080-08	RO.5	0.4°	8	0.8	16°
HFTNB 3010-100-08	10	60	6	8,690	7.89°	10.07	10.38	10.71	11.07	11.87						
HFTNB 3010-120-08	12	60	6	8,690	7.13°	12.08	12.46	12.86	13.29	14.26						
HFTNB 3010-160-08	16	60	6	8,690	5.98°	16.10	16.61	17.16	17.74	19.03						
HFTNB 3010-200-08	20	60	6	11,040	5.15°	20.13	20.77	21.45	22.18	23.81						
HFTNB 3010-260-08	26	70	6	11,590	4.26°	26.17	27.00	27.89	28.85	30.97						
HFTNB 3010-300-08	30	70	6	12,140	3.82°	30.19	31.16	32.19	33.29	35.75						
HFTNB 3010-060-18	0.9°	6	60	6	8,690	10.11°	—	6.06	6.25	6.45	6.90					
HFTNB 3010-080-18		8	60	6	8,690	8.94°	—	8.07	8.33	8.60	9.21					
HFTNB 3010-100-18		10	60	6	8,690	8.01°	—	10.08	10.41	10.75	11.53					
HFTNB 3010-120-18		12	60	6	8,690	7.25°	—	12.10	12.49	12.91	13.84					
HFTNB 3010-160-18		16	60	6	8,690	6.10°	—	16.12	16.65	17.21	18.47					
HFTNB 3010-200-18		20	60	6	11,040	5.26°	—	20.15	20.81	21.52	23.09					
HFTNB 3010-260-18		26	70	6	11,590	4.36°	—	26.19	27.05	27.98	30.03					
HFTNB 3010-300-18		30	70	6	12,140	3.91°	—	30.21	31.21	32.28	34.66					
HFTNB 3010-100-28		1.4°	10	60	6	8,690	8.13°	—	—	10.10	10.43		11.18			
HFTNB 3010-120-28	12		60	6	8,690	7.38°	—	—	12.11	12.52	13.42					
HFTNB 3010-160-28	16		60	6	8,690	6.22°	—	—	16.14	16.68	17.90					
HFTNB 3010-200-28	20		60	6	11,040	5.37°	—	—	20.17	20.85	22.38					
HFTNB 3010-260-28	26		70	6	11,590	4.46°	—	—	26.21	27.10	29.09					
HFTNB 3015-100-08	RO.75		0.4°	10	1.2	16°	60	6	A	9,110	7.55°	10.11	10.41	10.74	11.09	11.87
HFTNB 3015-160-08		16		60			6	9,940		5.64°	16.14	16.65	17.18	17.75	19.03	
HFTNB 3015-200-08		20		60			6	9,940		4.82°	20.17	20.80	21.48	22.20	23.81	
HFTNB 3015-300-08		30		70			6	10,760		3.54°	30.23	31.19	32.21	33.31	35.75	
HFTNB 3015-100-18		0.9°	10	60			6	9,110		7.66°	—	10.13	10.45	10.79	11.54	
HFTNB 3015-160-18			16	60			6	9,940		5.75°	—	16.17	16.69	17.24	18.48	
HFTNB 3015-200-18			20	60			6	9,940		4.93°	—	20.19	20.85	21.55	23.11	
HFTNB 3015-300-18			30	70			6	10,760		3.63°	—	30.26	31.25	32.31	34.67	
HFTNB 3015-100-28		1.4°	10	60			6	9,110		7.79°	—	—	10.15	10.48	11.21	
HFTNB 3015-160-28			16	60			6	9,940		5.87°	—	—	16.19	16.73	17.93	
HFTNB 3015-200-28			20	60			6	9,940		5.03°	—	—	20.22	20.90	22.41	
HFTNB 3015-300-28			30	80			6	10,760		3.72°	—	—	30.28	31.31	33.60	

Next Page ➡

3 Flutes

UDC Series

CBN Series

Square

Long Neck Square

Radius

Long Neck Radius

Taper Neck Radius

Ball / Long Shank Ball

Long Neck Ball

Taper Neck Ball

Taper

Spiral V Cutter

Drill

EURO Series

Technical Data

Model Number	Radius of Ball Nose R	Neck Taper Angle TN	Neck Length ℓ_2	Length of Cut ℓ	Shank Taper Angle Bta	Overall Length L	Shank Diameter ϕd	Shape	Price ¥	Interference Angle	Effective Length by Inclined Angles - : Interference							
											30'	1°	1°30'	2°	3°			
HFTNB 3020-120-08	R1	0.4°	12	1.6	16°	60	6	A	9,100	6.40°	12.12	12.49	12.87	13.29	14.22			
HFTNB 3020-160-08			16						9,320	5.27°	16.15	16.64	17.17	17.73	18.99			
HFTNB 3020-200-08			20						9,940	4.47°	20.17	20.80	21.46	22.18	23.77			
HFTNB 3020-220-08			22						9,940	4.16°	22.18	22.87	23.61	24.40	26.16			
HFTNB 3020-260-08			26						11,040	3.65°	26.21	27.03	27.90	28.84	30.93			
HFTNB 3020-300-08			30						12,140	3.25°	30.23	31.18	32.20	33.29	35.71			
HFTNB 3020-320-08			32						12,140	3.08°	32.25	33.26	34.35	35.51	38.09			
※ HFTNB 3020-360-08			36						12,140	2.79°	36.26	37.40	38.63	39.94	No Interference			
HFTNB 3020-400-08			40						14,350	2.55°	40.30	41.57	42.94	44.40	No Interference			
HFTNB 3020-120-18			0.9°						12	60	6	9,100	6.52°	—	12.15	12.52	12.93	13.83
HFTNB 3020-160-18		16							60	6	9,320	5.38°	—	16.17	16.68	17.23	18.46	
HFTNB 3020-200-18		20							60	6	9,940	4.57°	—	20.20	20.85	21.54	23.08	
HFTNB 3020-260-18		26							70	6	11,040	3.74°	—	26.24	27.09	28.00	30.02	
HFTNB 3020-300-18		30							70	6	12,140	3.33°	—	30.26	31.25	32.30	34.65	
HFTNB 3020-360-18		36							80	6	12,140	2.86°	—	36.30	37.49	38.76	No Interference	
HFTNB 3020-400-18		40							80	6	14,350	2.62°	—	40.33	41.65	43.06	No Interference	
HFTNB 3020-500-18		50							100	6	16,000	2.16°	—	50.39	52.05	53.83	No Interference	
HFTNB 3020-160-28		1.4°							16	60	6	9,320	5.49°	—	—	16.20	16.73	17.92
HFTNB 3020-200-28									20	60	6	9,940	4.68°	—	—	20.23	20.90	22.40
HFTNB 3020-260-28			26						70	6	11,040	3.83°	—	—	26.27	27.15	29.11	
HFTNB 3020-300-28	30		70	6	12,140	3.41°	—	—	30.30	31.32	33.59							
HFTNB 3020-400-28	40		80	6	15,070	2.69°	—	—	40.36	41.73	No Interference							
HFTNB 3020-620-38	1.9°		62	—	100	6	B	18,000	—	—	—	No Interference						
HFTNB 3020-410-58	2.9°	41	—	80	6	B	17,000	—	—	—	No Interference							
HFTNB 3030-200-08	R1.5	0.4°	20	2.4	16°	60	6	A	11,200	3.67°	20.23	20.84	21.49	22.19	23.75			
HFTNB 3030-260-08			26						70	6	11,960	2.94°	26.27	27.07	27.93	28.86	No Interference	
HFTNB 3030-300-08			30						70	6	13,660	2.60°	30.29	31.23	32.23	33.30	No Interference	
HFTNB 3030-320-08			32						80	6	14,350	2.46°	32.31	33.31	34.38	35.52	No Interference	
※ HFTNB 3030-360-08			36						80	6	14,950	2.21°	36.31	37.45	38.65	39.95	No Interference	
HFTNB 3030-400-08			40						80	6	15,180	2.01°	40.36	41.62	42.97	44.41	No Interference	
HFTNB 3030-200-18			0.9°						20	60	6	11,200	3.76°	—	20.27	20.90	21.58	23.09
HFTNB 3030-300-18									30	70	6	13,660	2.67°	—	30.34	31.31	32.34	No Interference
HFTNB 3030-400-18									40	80	6	15,180	2.07°	—	40.40	41.71	43.11	No Interference
HFTNB 3030-500-18									50	100	6	17,500	1.69°	—	50.46	52.11	No Interference	No Interference
HFTNB 3030-600-18		60							100	6	19,000	1.43°	—	60.52	No Interference	No Interference	No Interference	
HFTNB 3030-400-28		40							80	6	15,180	2.12°	—	—	40.45	41.80	No Interference	
HFTNB 3030-500-28		1.4°	50						100	6	17,000	1.74°	—	—	50.51	No Interference	No Interference	
HFTNB 3030-650-28			65						—	100	6	B	19,000	—	—	—	No Interference	No Interference
HFTNB 3040-300-18			0.9°						30	80	6	13,330	1.90°	—	30.51	31.47	No Interference	No Interference
HFTNB 3040-400-18									40	80	6	17,250	1.45°	—	40.58	No Interference	No Interference	No Interference
HFTNB 3040-500-18		50							100	6	19,000	1.18°	—	50.64	No Interference	No Interference	No Interference	
HFTNB 3040-600-18		60							100	6	20,200	0.99°	—	No Interference	No Interference	No Interference	No Interference	
HFTNB 3040-480-28		1.4°							48	—	80	6	B	17,250	—	—	—	No Interference

※Additional model

Milling Conditions for HFTNB

WORK MATERIAL			PREHARDENED STEELS / HARDENED STEELS NAK / SKD (30~45HRC)				HARDENED STEELS SKD / SKT (45~55HRC)				HARDENED STEELS SKD / SKH (55~65HRC)			
Model Number	Radius of Ball Nose (mm)	Neck Length (mm)	Spindle Speed (min ⁻¹)	Feed Rate (mm/min)	a _p Axial Depth (mm)	a _e Radial Depth (mm)	Spindle Speed (min ⁻¹)	Feed Rate (mm/min)	a _p Axial Depth (mm)	a _e Radial Depth (mm)	Spindle Speed (min ⁻¹)	Feed Rate (mm/min)	a _p Axial Depth (mm)	a _e Radial Depth (mm)
3010	R0.5	6	14,500	1,300	0.1	0.2	14,500	1,250	0.06	0.12	14,500	1,200	0.04	0.08
		8	14,000	1,200	0.09	0.18	13,750	1,160	0.06	0.1	13,500	1,120	0.04	0.06
		10	13,300	1,000	0.08	0.16	12,650	1,000	0.05	0.09	12,000	1,000	0.04	0.05
		12	13,000	870	0.07	0.14	12,000	850	0.04	0.08	11,000	880	0.03	0.05
		16	12,500	680	0.05	0.1	10,250	600	0.04	0.06	8,000	550	0.03	0.04
		20	12,000	600	0.04	0.08	9,500	500	0.03	0.06	7,000	400	0.02	0.04
		26	11,700	520	0.03	0.06	8,600	370	0.02	0.04	5,500	220	0.02	0.03
		30	11,500	500	0.02	0.05	8,250	350	0.02	0.04	5,000	200	0.02	0.03
3015	R0.75	10	12,000	1,230	0.13	0.3	11,500	1,100	0.09	0.2	11,000	1,100	0.06	0.14
		16	11,200	930	0.1	0.25	10,600	910	0.07	0.16	10,000	900	0.05	0.11
		20	10,800	750	0.08	0.22	9,500	700	0.06	0.14	8,200	680	0.04	0.09
		30	10,000	550	0.06	0.16	8,300	450	0.04	0.1	6,600	380	0.03	0.08
3020	R1	12	10,300	1,200	0.16	0.38	10,150	1,130	0.12	0.25	10,000	1,100	0.1	0.18
		16	10,000	1,100	0.15	0.35	9,900	1,100	0.1	0.23	9,800	1,050	0.09	0.16
		20	9,500	950	0.15	0.32	9,300	940	0.1	0.21	9,000	930	0.08	0.15
		22	9,400	900	0.14	0.3	9,100	850	0.09	0.2	8,600	840	0.08	0.14
		26	9,300	750	0.12	0.28	8,700	730	0.08	0.2	8,000	700	0.07	0.13
		30	9,200	630	0.11	0.25	8,400	590	0.08	0.17	7,500	550	0.05	0.1
		32	8,800	580	0.1	0.24	8,200	550	0.07	0.16	7,300	480	0.04	0.1
		36	8,700	570	0.09	0.22	7,900	510	0.07	0.16	7,000	450	0.04	0.1
		40	8,300	500	0.08	0.2	7,500	450	0.06	0.15	6,600	400	0.04	0.1
		41	8,300	500	0.08	0.2	7,500	450	0.06	0.15	6,600	400	0.04	0.1
		50	8,000	430	0.06	0.15	6,700	340	0.04	0.12	5,300	250	0.03	0.1
		62	7,500	350	0.04	0.1	6,000	350	0.04	0.13	5,000	300	0.02	0.05
3030	R1.5	20	9,000	1,150	0.25	0.48	8,900	1,100	0.18	0.36	8,800	1,100	0.12	0.25
		26	8,600	1,000	0.22	0.42	8,300	1,000	0.16	0.32	8,200	980	0.11	0.22
		30	8,400	950	0.21	0.4	8,100	930	0.15	0.3	7,800	920	0.1	0.21
		32	8,300	900	0.2	0.37	7,800	860	0.14	0.28	7,400	840	0.09	0.2
		36	8,100	800	0.18	0.35	7,400	720	0.13	0.26	6,800	680	0.08	0.2
		40	8,000	720	0.17	0.33	7,000	630	0.12	0.24	6,000	550	0.08	0.19
		50	7,600	570	0.14	0.28	6,400	450	0.09	0.2	5,200	400	0.06	0.17
		60	7,200	480	0.12	0.24	6,000	400	0.07	0.18	4,700	320	0.05	0.16
		65	7,200	480	0.12	0.24	6,000	400	0.07	0.18	4,700	320	0.05	0.16

UDC Series

CBN Series

Square

Long Neck Square

Radius

Long Neck Radius

Taper Neck Radius

Ball / Long Shank Ball

Long Neck Ball

Taper Neck Ball

Taper

Spiral V Cutter

Drill

EURO Series

Technical Data

Milling Conditions for HFTNB

WORK MATERIAL			PREHARDENED STEELS / HARDENED STEELS NAK / SKD (30~45HRC)				HARDENED STEELS SKD / SKT (45~55HRC)				HARDENED STEELS SKD / SKH (55~65HRC)			
Model Number	Radius of Ball Nose (mm)	Neck Length (mm)	Spindle Speed (min ⁻¹)	Feed Rate (mm/min)	a_p Axial Depth (mm)	a_e Radial Depth (mm)	Spindle Speed (min ⁻¹)	Feed Rate (mm/min)	a_p Axial Depth (mm)	a_e Radial Depth (mm)	Spindle Speed (min ⁻¹)	Feed Rate (mm/min)	a_p Axial Depth (mm)	a_e Radial Depth (mm)
3040	R2	30	8,000	1,100	0.35	0.55	7,800	1,050	0.24	0.4	7,600	1,000	0.16	0.33
		40	7,500	930	0.3	0.48	7,300	900	0.2	0.35	7,000	900	0.15	0.3
		48	7,200	750	0.26	0.42	6,500	650	0.16	0.3	5,800	600	0.13	0.27
		50	7,200	750	0.26	0.42	6,500	650	0.16	0.3	5,800	600	0.13	0.27
		60	7,000	600	0.22	0.36	6,000	520	0.13	0.26	5,000	440	0.11	0.25

Note:

- Decrease both spindle speed and feed rate proportionally when the milling parameters exceed the machine's maximum spindle speed.
- Decrease the feed rate more than 50% from the milling parameters when slot milling.
- Every coolant offers stable milling.

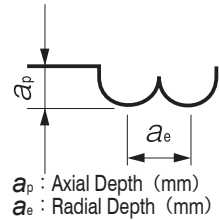

Roughness Comparison

HFTNB R1 × Neck Length 20 × Neck Taper Angle 0.4° SKD61 (48HRC)

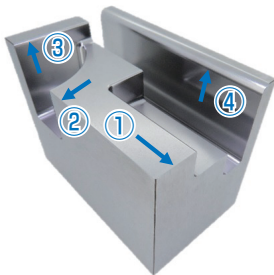

Work Size : 30 x 50 x 40 mm

Measurement Spot	Surface Roughness Ra (μm)	
	HFTNB	Competitor
①	0.353	0.451
②	0.480	0.865
③	0.200	0.270
④	0.168	0.248

Better surface roughness compared to competitor's!

No.	Milling Process	Tool	Spindle Speed (min ⁻¹)	Feed Rate (mm/min)	Axial Depth a_p (mm)	Radial Depth a_e (mm)	Allowance (mm)	Coolant	Cycle Time
1	Roughing	HSLB 2060-200 (R3 x Effective Length 20)	13,000	3,500	0.6	0.6	0.05	Air Blow	0:25:33
2	Semi-finishing	HSLB 2030-200 (R1.5 x Effective Length 20)	14,500	1,360	0.18	0.1	0.02		0:49:48
3	Finishing	HFTNB 3020-200-08 / Competitor (R1 x Neck Length 20 x Neck Taper Angle 0.4°)	4,650	940	0.05	0.05	0		2:29:29

Total 3:44:50

Taper Pocket Milling Examples
HFTNB R1 × Neck Length 30 × Neck Taper Angle 0.9° SKD61 (50HRC)

Milling Shape : Taper Pocket 25 x 5 x Depth 4 mm Vertical Wall Inclined Angle 1°

Tools after milling

HFTNB

After 40 min



After 120 min



Normal wear condition after 120 min milling. No chipping or any damages.

Competitor A After 40 min

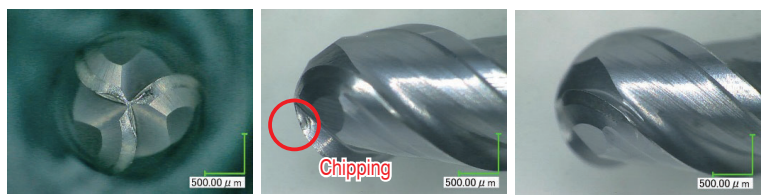

Chipping on the cutting edges of all 3 flutes after 40 min.

Competitor B After 40 min

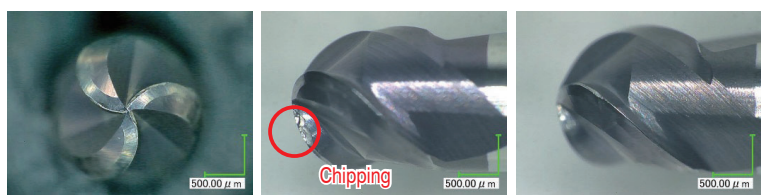

Large chipping on the cutting edge after 40 min. Chipping also on the other 2 flutes.

High durability throughout the long cycle time.

Tool	Spindle Speed (min ⁻¹)	Feed Rate (mm/min)	Axial Depth a_p (mm)	Radial Depth a_e (mm)	Coolant	Cycle Time
HFTNB 3020-300-18	8,400	590	0.08	0.17	Air Blow	40 min / pocket

UDC Series

CBN Series

Square
Long Neck Square

Radius
Long Neck Radius

Taper Neck Radius

Ball / Long Shank Ball

Ball
Long Neck Ball
Taper Neck Ball

Taper
Taper

Spiral V Cutter

Drill

EURO Series

Technical Data



Size $\phi 0.2 \sim \phi 2.5$

C-CTE2000



$\phi 0.2 \sim \phi 0.4$ $\phi 0.5 \sim \phi 2.5$

Material Applications (☆ Highly Recommended ○ Recommended ○ Suggested)

Work Material															
Carbon Steels S45C S55C	Alloy Steels SK / SCM SUS	Prehardened Steels NAK HPM	Hardened Steels			Cast Iron	Aluminum Alloys	Graphite	Copper	Plastics	Glass Filled Plastics	Titanium Alloys	Heat Resistant Alloys	Cemented Carbide	Hard Brittle (Non-Metallic) Materials
			~55HRC	~60HRC	~70HRC										
○	○	○	○			○			○						

Features

Extensive line up of tapered design from 30° to 15° of half included angle.
Refer to page 538 for 4 flute C-CTE.

Total 108 models

Unit (mm)

Model Number	Tip Diameter	Half Included Angle	Length of Cut	Dia. at Large End	Overall Length	Shank Diameter	Price ¥
C-CTE 2002-1	0.2	30°	0.8	0.21	38	3	15,500
C-CTE 2002-2		1°		0.23	38	3	15,500
C-CTE 2002-3		1°30'		0.24	38	3	15,500
C-CTE 2002-4		2°		0.26	38	3	15,500
C-CTE 2002-6		3°		0.28	38	3	15,500
C-CTE 2002-8		4°		0.31	38	3	16,500
C-CTE 2002-10		5°		0.34	38	3	18,500
C-CTE 2002-14		7°		0.40	38	3	20,000
C-CTE 2002-20		10°		0.48	38	3	22,000
C-CTE 2003-1		0.3		30°	1.2	0.32	38
C-CTE 2003-2	1°		0.34	38		3	13,000
C-CTE 2003-3	1°30'		0.36	38		3	13,000
C-CTE 2003-4	2°		0.38	38		3	13,000
C-CTE 2003-6	3°		0.43	38		3	13,000
C-CTE 2003-8	4°		0.47	38		3	14,000
C-CTE 2003-10	5°		0.51	38		3	15,000
C-CTE 2003-14	7°		0.59	38		3	16,500
C-CTE 2003-20	10°		0.72	38		3	18,500

Next Page ➡

Unit (mm)

Model Number	Tip Diameter	Half Included Angle	Length of Cut	Dia. at Large End	Overall Length	Shank Diameter	Price ¥		
C-CTE 2004-1	0.4	30°	1.6	0.43	38	3	13,000		
C-CTE 2004-2		1°		0.46	38	3	13,000		
C-CTE 2004-3		1°30'		0.48	38	3	13,000		
C-CTE 2004-4		2°		0.51	38	3	13,000		
C-CTE 2004-6		3°		0.57	38	3	13,000		
C-CTE 2004-8		4°		0.62	38	3	14,000		
C-CTE 2004-10		5°		0.68	38	3	15,000		
C-CTE 2004-14		7°		0.79	38	3	16,500		
C-CTE 2004-20		10°		0.96	38	3	18,500		
C-CTE 2005-1		0.5		30°	2	0.53	38	3	12,960
C-CTE 2005-2	1°		0.57	38		3	12,960		
C-CTE 2005-3	1°30'		0.60	38		3	12,960		
C-CTE 2005-4	2°		0.64	38		3	12,960		
C-CTE 2005-6	3°		0.71	38		3	12,960		
C-CTE 2005-8	4°		0.78	38		3	14,040		
C-CTE 2005-10	5°		0.85	38		3	15,120		
C-CTE 2005-14	7°		0.99	38		3	17,280		
C-CTE 2005-20	10°		1.21	38		3	18,360		
C-CTE 2005-24	12°		1.35	38		3	18,960		
C-CTE 2005-30	15°		1.57	38		3	19,680		
C-CTE 2006-1	0.6		30°	2		0.63	38	3	12,120
C-CTE 2006-2			1°			0.67	38	3	12,120
C-CTE 2006-3			1°30'			0.70	38	3	12,120
C-CTE 2006-4		2°	0.74		38	3	12,120		
C-CTE 2006-5		2°30'	0.77		38	3	12,120		
C-CTE 2006-6		3°	0.81		38	3	12,120		
C-CTE 2006-10		5°	0.95		38	3	14,280		
C-CTE 2006-14		7°	1.09		38	3	16,440		
C-CTE 2006-20		10°	1.31		38	3	17,520		
C-CTE 2006-24		12°	1.45		38	3	18,000		
C-CTE 2006-30	15°	1.67	38	3	18,600				
C-CTE 2008-1	0.8	30°	3	0.85	38	3	12,120		
C-CTE 2008-2		1°		0.90	38	3	12,120		
C-CTE 2008-3		1°30'		0.96	38	3	12,120		
C-CTE 2008-4		2°		1.01	38	3	12,120		
C-CTE 2008-5		2°30'		1.06	38	3	12,120		
C-CTE 2008-6		3°		1.11	38	3	12,120		
C-CTE 2008-10		5°		1.32	38	3	14,280		
C-CTE 2008-14		7°		1.54	38	3	16,440		
C-CTE 2008-20		10°		1.86	38	3	17,520		
C-CTE 2008-24		12°		2.08	38	3	18,000		
C-CTE 2008-30		15°		2.41	38	3	18,600		
C-CTE 2010-1		1		30°	4	1.07	45	4	9,480
C-CTE 2010-2	1°		1.14	45		4	9,480		
C-CTE 2010-3	1°30'		1.21	45		4	9,480		

Next Page ➡

UDC Series

CBN Series

Square

Long Neck Square

Radius

Long Neck Radius

Taper Neck Radius

Ball / Long Shank Ball

Long Neck Ball

Taper Neck Ball

Taper

Spiral V Cutter

Drill

EURO Series

Technical Data

Unit (mm)

Model Number	Tip Diameter	Half Included Angle	Length of Cut	Dia. at Large End	Overall Length	Shank Diameter	Price ¥		
C-CTE 2010-4	1	2°	4	1.28	45	4	9,480		
C-CTE 2010-5		2°30'		1.35	45	4	9,480		
C-CTE 2010-6		3°		1.42	45	4	9,720		
C-CTE 2010-8		4°		1.56	45	4	11,760		
C-CTE 2010-10		5°		1.70	45	4	11,760		
C-CTE 2010-14		7°		1.98	45	4	15,720		
C-CTE 2010-20		10°		2.41	45	4	16,800		
C-CTE 2010-24		12°		2.70	45	4	18,000		
C-CTE 2010-30		15°		3.14	50	6	18,720		
C-CTE 2015-1		1.5		30'	5	1.59	45	4	9,480
C-CTE 2015-2	1°		1.67	45		4	9,480		
C-CTE 2015-3	1°30'		1.76	45		4	9,480		
C-CTE 2015-4	2°		1.85	45		4	9,480		
C-CTE 2015-5	2°30'		1.94	45		4	9,480		
C-CTE 2015-6	3°		2.02	45		4	9,720		
C-CTE 2015-8	4°		2.20	45		4	11,760		
C-CTE 2015-10	5°		2.37	45		4	11,760		
C-CTE 2015-14	7°		2.73	45		4	15,720		
C-CTE 2015-20	10°		3.26	45		4	16,800		
C-CTE 2015-24	12°		3.63	45		4	18,000		
C-CTE 2015-30	15°		4.18	50		6	18,720		
C-CTE 2020-1	2		30'	6		2.10	45	4	9,480
C-CTE 2020-2			1°			2.21	45	4	9,480
C-CTE 2020-3		1°30'	2.31		45	4	9,480		
C-CTE 2020-4		2°	2.42		45	4	9,480		
C-CTE 2020-5		2°30'	2.52		45	4	9,480		
C-CTE 2020-6		3°	2.63		45	4	9,720		
C-CTE 2020-8		4°	2.84		45	4	10,080		
C-CTE 2020-10		5°	3.05		45	4	11,200		
C-CTE 2020-14		7°	3.47		45	4	15,720		
C-CTE 2020-20		10°	4.12		50	6	18,720		
C-CTE 2020-24		12°	4.55		50	6	19,680		
C-CTE 2020-30		15°	5.22		50	6	20,640		
C-CTE 2025-1		2.5	30'		8	2.64	45	4	10,800
C-CTE 2025-2			1°			2.78	45	4	10,800
C-CTE 2025-3	1°30'		2.92	45		4	10,800		
C-CTE 2025-4	2°		3.06	45		4	10,800		
C-CTE 2025-5	2°30'		3.20	45		4	10,800		
C-CTE 2025-6	3°		3.34	45		4	10,800		
C-CTE 2025-8	4°		3.62	45		4	11,100		
C-CTE 2025-10	5°		3.90	45		4	11,400		
C-CTE 2025-14	7°		4.45	45		6	13,340		
C-CTE 2025-20	10°		5.32	50		6	24,150		
C-CTE 2025-24	12°		5.90	50		8	26,400		
C-CTE 2025-30	15°		6.79	50		8	27,500		

UDC Series

CBN Series

Square
Long Neck Square

Radius
Long Neck Radius
Taper Neck Radius

Ball / Long Shank Ball
Long Neck Ball
Taper Neck Ball

Taper

Spiral V Cutter

Drill

EURO Series

Technical Data

Milling Conditions for C-CTE (2 Flutes)

WORK MATERIAL		CARBON STEELS ALLOY STEELS (~325HB)		TOOL STEELS PREHARDENED STEELS (30~40HRC)		PREHARDENED STEELS HARDENED STEELS (40~50HRC)	
Model Number	Tip Diameter (mm)	Spindle Speed (min ⁻¹)	Feed Rate (mm/min)	Spindle Speed (min ⁻¹)	Feed Rate (mm/min)	Spindle Speed (min ⁻¹)	Feed Rate (mm/min)
2002	0.2	32,000	45	25,000	30	18,000	20
2003	0.3	30,000	50	23,000	30	16,200	25
2004	0.4	28,000	60	21,000	35	14,500	25
2005	0.5	25,500	70	19,100	40	12,700	25
2006	0.6	21,300	70	15,900	40	10,600	25
2008	0.8	15,900	100	11,900	60	8,000	40
2010	1	12,800	150	9,600	110	6,400	70
2015	1.5	8,500	150	6,400	110	4,300	70
2020	2	6,400	150	4,800	110	3,200	70
2025	2.5	5,100	150	3,800	110	2,600	70

Milling Amount for Side Milling (mm)

\varnothing = Length of Cut

$\Delta t = \tan \text{Half Included Taper Angle} \times 0.9 \varnothing$

Note:

- Recommend water soluble or oil coolant.
- Recommend wet coolant for Copper.

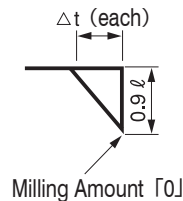

UDC Series
CBN Series
Square
Long Neck Square
Radius
Long Neck Radius
Taper Neck Radius
Ball / Long Shank Ball
Long Neck Ball
Taper Neck Ball
Taper
Spiral V Cutter
Drill
EURO Series
Technical Data



Size $\phi 3 \sim \phi 10$

C-CTE4000



Material Applications (☆ Highly Recommended ○ Recommended ○ Suggested)

Work Material															
Carbon Steels S45C S55C	Alloy Steels SK / SCM SUS	Prehardened Steels NAK HPM	Hardened Steels			Cast Iron	Aluminum Alloys	Graphite	Copper	Plastics	Glass Filled Plastics	Titanium Alloys	Heat Resistant Alloys	Cemented Carbide	Hard Brittle (Non-Metallic) Materials
			~55HRC	~60HRC	~70HRC										
○	○	○	○			○			○						

Features

Extensive line up of tapered design from 30° to 7° of half included angle.
Refer to page 534 for 2 flute C-CTE.

Total 46 models

Unit (mm)

Model Number	Tip Diameter	Half Included Angle	Length of Cut	Dia. at Large End	Overall Length	Shank Diameter	Price ¥
C-CTE 4030-1	3	30°	10	3.17	50	6	11,340
C-CTE 4030-2		1°		3.35	50	6	11,340
C-CTE 4030-3		1°30'		3.52	50	6	11,340
C-CTE 4030-4		2°		3.70	50	6	11,340
C-CTE 4030-5		2°30'		3.87	50	6	11,340
C-CTE 4030-6		3°		4.05	50	6	11,340
C-CTE 4030-10		5°		4.75	50	6	12,290
C-CTE 4030-14		7°		5.46	50	6	13,650
C-CTE 4040-1		4		30°	15	4.26	50
C-CTE 4040-2	1°		4.52	50		6	11,760
C-CTE 4040-3	1°30'		4.79	50		6	11,760
C-CTE 4040-4	2°		5.05	50		6	11,760
C-CTE 4040-5	2°30'		5.31	50		6	11,760
C-CTE 4040-6	3°		5.57	50		6	11,760
C-CTE 4040-10	5°		6.63	50		8	16,280
C-CTE 4040-14	7°		7.68	50		8	18,150

Next Page ➔

Unit (mm)

Model Number	Tip Diameter	Half Included Angle	Length of Cut	Dia. at Large End	Overall Length	Shank Diameter	Price ¥
C-CTE 4050-1	5	30'	20	5.35	60	6	13,650
C-CTE 4050-2		1°		5.70	60	6	13,650
C-CTE 4050-3		1°30'		6.05	60	8	14,300
C-CTE 4050-4		2°		6.40	60	8	14,300
C-CTE 4050-5		2°30'		6.75	60	8	14,300
C-CTE 4050-6		3°		7.10	60	8	14,300
C-CTE 4050-10		5°		8.50	60	10	21,780
C-CTE 4050-14		7°		9.91	60	10	24,200
C-CTE 4060-1	6	30'	20	6.35	60	8	14,300
C-CTE 4060-2		1°		6.70	60	8	14,300
C-CTE 4060-3		1°30'		7.05	60	8	14,300
C-CTE 4060-4		2°		7.40	60	8	14,300
C-CTE 4060-5		2°30'		7.75	60	8	15,840
C-CTE 4060-6		3°		8.10	60	10	15,840
C-CTE 4060-10		5°		9.50	60	10	23,320
C-CTE 4060-14		7°		10.91	60	12	25,960
C-CTE 4080-1	8	30'	25	8.44	70	10	22,440
C-CTE 4080-2		1°		8.87	70	10	23,100
C-CTE 4080-3		1°30'		9.31	70	10	24,750
C-CTE 4080-4		2°		9.75	70	10	26,070
C-CTE 4080-5		2°30'		10.18	75	12	28,600
C-CTE 4080-6		3°		10.62	75	12	30,360
C-CTE 4080-10		5°		12.37	90	12	52,800
C-CTE 4100-1		10		30'	35	10.61	90
C-CTE 4100-2	1°		11.22	90		12	40,260
C-CTE 4100-3	1°30'		11.83	90		12	42,900
C-CTE 4100-4	2°		12.44	90		12	49,500
C-CTE 4100-5	2°30'		13.05	90		12	53,900
C-CTE 4100-6	3°		13.67	90		12	57,750
C-CTE 4100-10	5°		16.12	90		16	69,300

4 Flutes

UDC Series

CBN Series

Square

Long Neck Square

Radius

Radius

Long Neck Radius

Taper Neck Radius

Ball / Long Shank Ball

Ball

Long Neck Ball

Taper Neck Ball

Taper

Spiral V Cutter

Drill

EURO Series

Technical Data

Milling Conditions for C-CTE (4 Flutes)

WORK MATERIAL		CARBON STEELS ALLOY STEELS (~325HB)		TOOL STEELS PREHARDENED STEELS (30~40HRC)		PREHARDENED STEELS HARDENED STEELS (40~50HRC)	
Model Number	Tip Diameter (mm)	Spindle Speed (min ⁻¹)	Feed Rate (mm/min)	Spindle Speed (min ⁻¹)	Feed Rate (mm/min)	Spindle Speed (min ⁻¹)	Feed Rate (mm/min)
4030	3	4,200	200	3,200	150	2,100	90
4040	4	3,200	200	2,400	150	1,600	90
4050	5	2,600	200	1,900	150	1,300	90
4060	6	2,100	200	1,600	150	1,100	90
4080	8	1,600	200	1,200	150	800	90
4100	10	1,300	200	1,000	150	600	90

Milling Amount for Side Milling(mm)

ℓ = Length of Cut

$$\Delta t = \tan \text{ Half Included Taper Angle} \times 0.9 \ell$$

Note:

- Recommend water soluble or oil coolant.
- Recommend wet coolant for Copper.

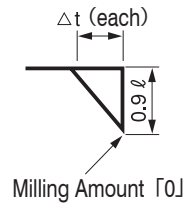

UDC Series

CBN Series

Square
Long Neck Square

Radius

Radius
Long Neck Radius
Taper Neck Radius

Ball / Long Shank Ball

Ball
Long Neck Ball
Taper Neck Ball

Taper

Spiral V Cutter

Drill

EURO Series

Technical Data



UDC Series

CBN Series

Square
Long Neck Square

Radius
Long Neck Radius
Taper Neck Radius

Ball / Long Shank Ball
Long Neck Ball
Taper Neck Ball

Taper
Taper

Spiral V Cutter

Drill

EURO Series

Technical Data



Size $\phi 3 \sim \phi 12$

SV



Material Applications (☆ Highly Recommended ○ Recommended ○ Suggested)

Work Material															
Carbon Steels S45C S55C	Alloy Steels SK / SCM SUS	Prehardened Steels NAK HPM	Hardened Steels			Cast Iron	Aluminum Alloys	Graphite	Copper	Plastics	Glass Filled Plastics	Titanium Alloys	Heat Resistant Alloys	Cemented Carbide	Hard Brittle (Non-Metallic) Materials
			~55HRC	~60HRC	~70HRC										
○	○	○				○	○	○	○	○					

Features

Spiral type Chamfering cutter.

Half included angle 45°.

By applying a spiral peripheral cutting edge, burrs are greatly reduced when compared to a straight cutting edge design.

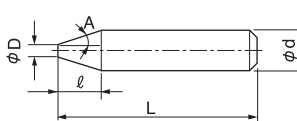
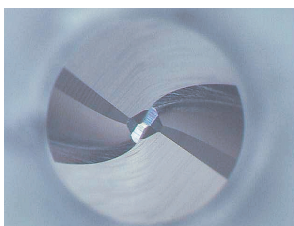

Total 6 models

Unit (mm)

Model Number	Tip Diameter ϕD	Length of Cut ℓ	Overall Length L	Half Included Angle A	Shank Diameter ϕd	Price ¥
SV 2030	0.8	1.1	40	45°	3	13,000
SV 2040		1.6	45		4	14,000
SV 2060	1	2.5	50		6	15,750
SV 2080		3.5	60		8	19,250
SV 2100		4.5	70		10	27,500
SV 2120		5.5	75		12	32,230

Milling Conditions for SV

WORK MATERIAL		CARBON STEELS S45C / S50C (~225HB)		ALLOY STEELS SK / SCM / SUS (225~325HB)		PREHARDENED STEELS HARDENED STEELS NAK / SKD (30~45HRC)	
Model Number	Shank Diameter (mm)	Spindle Speed (min ⁻¹)	Feed Rate (mm/min)	Spindle Speed (min ⁻¹)	Feed Rate (mm/min)	Spindle Speed (min ⁻¹)	Feed Rate (mm/min)
2030	3	2,700~5,300	59~86	2,100~4,200	46~67	1,600~3,200	35~51
2040	4	2,000~4,000	48~68	1,600~3,200	38~54	1,200~2,400	29~41
2060	6	1,300~2,700	36~49	1,100~2,100	31~42	800~1,600	22~30
2080	8	1,000~2,000	32~42	800~1,600	26~34	600~1,200	22~30
2100	10	800~1,600	30~37	640~1,300	23~29	600~1,200	17~22
2120	12	700~1,300	28~35	530~1,100	21~27	400~800	17~22

Milling Amount (mm)

$$a_p = 0.1D$$

a_p : Axial Depth (mm)

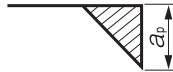

Note:

- The figures listed above are for nominal diameters. Adjust the speed and feed rate according to the correct diameter.
- Recommend slot milling with the tip flutes. Decrease the feed rate 50% from the milling parameters in this case.
- Recommend water soluble or oil coolant.

UDC Series

CBN Series

Square
Long Neck Square

Radius

Radius
Long Neck Radius

Taper Neck Radius

Ball / Long Shank Ball
Ball
Long Neck Ball

Taper Neck Ball

Taper

Spiral V Cutter

Drill

EURO Series

Technical Data



Size $\phi 2 \sim \phi 12$

UTDF



Patented in Japan

Material Applications (☆ Highly Recommended ○ Recommended ○ Suggested)

Work Material																
Structural Steels SS400	Carbon Steels S45C S55C	Alloy Steels SK / SCM SUS	Prehardened Steels NAK HPM	Hardened Steels			Cast Iron	Aluminum Alloys	Graphite	Copper	Plastics	Glass Filled Plastics	Titanium Alloys	Heat Resistant Alloys	Cemented Carbide	Hard Brittle (Non-Metallic) Materials
				~ 55HRC	~ 60HRC	~ 70HRC										
○	○	○	○				○	○								

Features

Available to a wide variety of applications by the 180° point angle.
 The helix angle of 30° offers excellent chip evacuation, stable and highly efficient pilot hole drilling.
 New web-thinning design for improved chip evacuation and sharpness.
 Double-margin will guide the tool into inner wall and achieve high-straightness drilling to non-planar surface.
 Size M4 - M12 for drilling pilot holes before tapping.

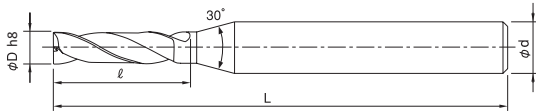

Outside Diameter	Diameter Tolerance(h8)
$\phi D \leq 3$	0/-0.014
$3 < \phi D \leq 6$	0/-0.018
$6 < \phi D \leq 10$	0/-0.022
$10 < \phi D \leq 12$	0/-0.027

Feature1 : Helix angle 30°



Excellent chip evacuation with 30° helix angle

Feature2 : Double-margin

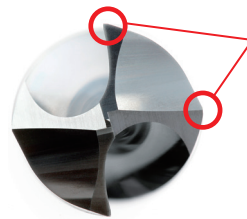

Double-margin

High-straightness drilling

Feature3 : A wide variety of applications

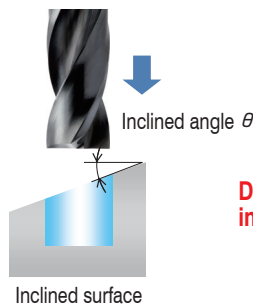
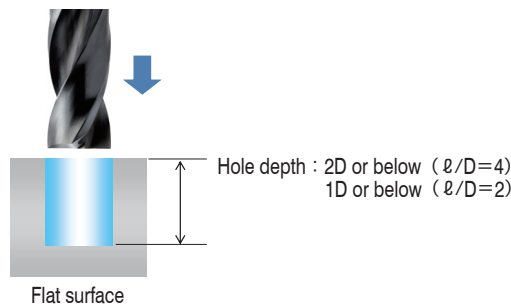

Designed for drilling on flat, inclined or curved surfaces.

Total 21 models

Unit (mm)

Model Number	Diameter ϕD	Flute Length ℓ	Overall Length L	Shank Diameter ϕd	Price ¥
UTDF 2200-080	2	8	50	4	6,500
UTDF 2250-100	2.5	10	50	4	6,500
UTDF 2300-120	3	12	60	6	6,500
UTDF 2330-132	3.3	13.2	60	6	7,000
UTDF 2400-160	4	16	60	6	7,200
UTDF 2420-168	4.2	16.8	60	6	7,500
UTDF 2500-200	5	20	60	6	7,800
UTDF 2510-204	5.1	20.4	60	6	7,800
UTDF 2600-240	6	24	60	6	8,000
UTDF 2650-130	6.5	13	70	8	9,700
UTDF 2680-272	6.8	27.2	70	8	9,700
UTDF 2700-280	7	28	80	8	9,700
UTDF 2800-320	8	32	80	8	10,500
UTDF 2850-340	8.5	34	80	10	11,500
UTDF 2860-344	8.6	34.4	80	10	11,500
UTDF 2900-360	9	36	80	10	13,500
UTDF 2950-190	9.5	19	90	10	13,500
UTDF 21000-400	10	40	90	10	13,500
UTDF 21030-412	10.3	41.2	90	12	14,000
UTDF 21100-220	11	22	100	12	15,500
UTDF 21200-480	12	48	100	12	15,500

*Contact our sales for the custom size tool.

UDC Series

CBN Series

Square

Long Neck Square

Radius

Long Neck Radius

Taper Neck Radius

Ball / Long Shank Ball

Long Neck Ball

Taper Neck Ball

Taper

Spiral V Cutter

Drill

EURO Series

Technical Data

Milling Conditions for UTDF

Flat Surface

WORK MATERIAL			CARBON STEELS STRUCTURAL STEELS GRAY CAST IRON S50C / SS400 / FC250	ALLOY STEELS SCM415	PREHARDENED STEELS NAK80	DUCTILE IRON FCD	ALUMINUM ALLOYS A5052 / A7075	ALUMINUM CAST ADC12						
Model Number	Diameter ϕD (mm)	Flute Length ℓ (mm)	Spindle Speed (min ⁻¹)	Feed Rate (mm/min)	Spindle Speed (min ⁻¹)	Feed Rate (mm/min)	Spindle Speed (min ⁻¹)	Feed Rate (mm/min)	Spindle Speed (min ⁻¹)	Feed Rate (mm/min)	Spindle Speed (min ⁻¹)	Feed Rate (mm/min)	Spindle Speed (min ⁻¹)	Feed Rate (mm/min)
2200-080	2	8	15,000	900	12,900	740	6,000	160	12,900	660	25,200	2,070	18,900	1,340
2250-100	2.5	10	12,000	880	10,320	730	4,800	160	10,320	660	20,160	2,070	15,120	1,340
2300-120	3	12	10,000	860	8,600	710	4,000	150	8,600	630	16,800	1,970	12,600	1,280
2330-132	3.3	13.2	9,090	860	7,820	710	3,640	150	7,820	630	15,280	1,970	11,460	1,280
2400-160	4	16	7,500	830	6,450	690	3,000	150	6,450	610	12,600	1,900	9,450	1,230
2420-168	4.2	16.8	7,150	830	6,150	690	2,860	150	6,150	610	12,000	1,900	9,000	1,230
2500-200	5	20	6,000	800	5,160	660	2,400	140	5,160	590	10,080	1,840	7,560	1,190
2510-204	5.1	20.4	5,880	800	5,060	660	2,350	140	5,060	590	9,880	1,840	7,400	1,190
2600-240	6	24	5,000	770	4,300	640	2,000	140	4,300	560	8,400	1,770	6,300	1,140
2650-130	6.5	13	4,620	770	3,970	640	1,850	140	3,970	560	7,750	1,770	5,820	1,140
2680-272	6.8	27.2	4,420	770	3,800	640	1,770	140	3,800	560	7,420	1,770	5,560	1,140
2700-280	7	28	4,290	760	3,680	630	1,710	140	3,680	560	7,200	1,770	5,400	1,140
2800-320	8	32	3,750	730	3,230	600	1,500	130	3,230	540	6,300	1,670	4,730	1,080
2850-340	8.5	34	3,530	730	3,040	600	1,420	130	3,040	540	5,930	1,670	4,450	1,080
2860-344	8.6	34.4	3,490	720	3,000	600	1,400	130	3,000	540	5,860	1,670	4,400	1,080
2900-360	9	36	3,330	720	2,870	590	1,330	120	2,870	530	5,600	1,670	4,200	1,080
2950-190	9.5	19	3,160	700	2,720	580	1,260	120	2,720	520	5,300	1,620	3,980	1,050
21000-400	10	40	3,000	690	2,580	570	1,200	120	2,580	510	5,040	1,580	3,780	1,020
21030-412	10.3	41.2	2,920	690	2,510	570	1,170	120	2,510	510	4,900	1,580	3,670	1,020
21100-220	11	22	2,730	670	2,350	550	1,090	110	2,350	500	4,580	1,540	3,440	1,000
21200-480	12	48	2,500	650	2,150	540	1,000	110	2,150	480	4,200	1,490	3,150	960

UDC Series

CBN Series

Square
Long Neck Square

Radius

Radius
Long Neck Radius
Taper Neck Radius

Ball / Long Shark Ball

Ball
Long Neck Ball
Taper Neck Ball

Taper

Spiral V Cutter

Drill

EURO Series

Technical Data

Milling Conditions for UTDF

Inclined Surface ($\theta \leq 30^\circ$)

WORK MATERIAL			CARBON STEELS STRUCTURAL STEELS GRAY CAST IRON S50C / SS400 / FC250		ALLOY STEELS SCM415		PREHARDENED STEELS NAK80		DUCTILE IRON FCD		ALUMINUM ALLOYS A5052 / A7075		ALUMINUM CAST ADC12	
Model Number	Diameter ϕ D (mm)	Flute Length l (mm)	Spindle Speed (min^{-1})	Feed Rate (mm/min)	Spindle Speed (min^{-1})	Feed Rate (mm/min)	Spindle Speed (min^{-1})	Feed Rate (mm/min)	Spindle Speed (min^{-1})	Feed Rate (mm/min)	Spindle Speed (min^{-1})	Feed Rate (mm/min)	Spindle Speed (min^{-1})	Feed Rate (mm/min)
2200-080	2	8	15,000	270	12,900	220	6,000	48	12,900	190	25,200	620	18,900	400
2250-100	2.5	10	12,000	260	10,320	220	4,800	48	10,320	190	20,160	620	15,120	400
2300-120	3	12	10,000	250	8,600	210	4,000	45	8,600	180	16,800	590	12,600	380
2330-132	3.3	13.2	9,090	250	7,820	210	3,640	45	7,820	180	15,280	590	11,460	380
2400-160	4	16	7,500	240	6,450	200	3,000	45	6,450	180	12,600	570	9,450	360
2420-168	4.2	16.8	7,150	240	6,150	200	2,860	45	6,150	180	12,000	570	9,000	360
2500-200	5	20	6,000	240	5,160	190	2,400	42	5,160	170	10,080	550	7,560	350
2510-204	5.1	20.4	5,880	230	5,060	190	2,350	42	5,060	170	9,880	550	7,400	350
2600-240	6	24	5,000	230	4,300	190	2,000	42	4,300	160	8,400	530	6,300	340
2650-130	6.5	13	4,620	230	3,970	190	1,850	42	3,970	160	7,750	530	5,820	340
2680-272	6.8	27.2	4,420	230	3,800	190	1,770	42	3,800	160	7,420	530	5,560	340
2700-280	7	28	4,290	230	3,680	190	1,710	42	3,680	160	7,200	530	5,400	340
2800-320	8	32	3,750	210	3,230	180	1,500	39	3,230	160	6,300	500	4,730	320
2850-340	8.5	34	3,530	210	3,040	180	1,420	39	3,040	160	5,930	500	4,450	320
2860-344	8.6	34.4	3,490	210	3,000	180	1,400	39	3,000	160	5,860	500	4,400	320
2900-360	9	36	3,330	210	2,870	180	1,330	38	2,870	160	5,600	500	4,200	320
2950-190	9.5	19	3,160	210	2,720	170	1,260	36	2,720	150	5,300	490	3,980	310
21000-400	10	40	3,000	200	2,580	170	1,200	36	2,580	150	5,040	470	3,780	300
21030-412	10.3	41.2	2,920	200	2,510	170	1,170	36	2,510	150	4,900	470	3,670	300
21100-220	11	22	2,730	200	2,350	160	1,090	34	2,350	140	4,580	460	3,440	290
21200-480	12	48	2,500	190	2,150	160	1,000	33	2,150	140	4,200	440	3,150	280

UDC
SeriesCBN
SeriesSquare
Long Neck
Square

Radius

Long Neck
Radius
Taper Neck
RadiusBall / Long
Shank BallBall
Long Neck
Ball
Taper Neck
Ball

Taper

Spiral
V Cutter

Drill

EURO Series

Technical Data

Milling Conditions for UTDF

Inclined Surface ($\theta > 30^\circ$)

WORK MATERIAL			CARBON STEELS STRUCTURAL STEELS GRAY CAST IRON S50C / SS400 / FC250	ALLOY STEELS SCM415	PREHARDENED STEELS NAK80	DUCTILE IRON FCD	ALUMINUM ALLOYS A5052 / A7075	ALUMINUM CAST ADC12						
Model Number	Diameter ϕD (mm)	Flute Length ℓ (mm)	Spindle Speed (min ⁻¹)	Feed Rate (mm/min)	Spindle Speed (min ⁻¹)	Feed Rate (mm/min)	Spindle Speed (min ⁻¹)	Feed Rate (mm/min)	Spindle Speed (min ⁻¹)	Feed Rate (mm/min)	Spindle Speed (min ⁻¹)	Feed Rate (mm/min)	Spindle Speed (min ⁻¹)	Feed Rate (mm/min)
2200-080	2	8	10,500	90	9,030	74	4,200	16	9,030	66	17,640	200	13,230	130
2250-100	2.5	10	8,400	90	7,220	74	3,360	16	7,220	66	14,110	200	10,580	130
2300-120	3	12	7,000	86	6,020	71	2,800	15	6,020	63	11,760	190	8,820	120
2330-132	3.3	13.2	6,370	86	5,480	71	2,550	15	5,480	63	10,700	190	8,030	120
2400-160	4	16	5,250	83	4,520	69	2,100	15	4,520	61	8,820	190	6,620	120
2420-168	4.2	16.8	5,010	83	4,310	69	2,010	15	4,310	61	8,400	190	6,300	120
2500-200	5	20	4,200	80	3,620	66	1,680	14	3,620	59	7,060	180	5,300	110
2510-204	5.1	20.4	4,120	80	3,540	66	1,650	14	3,540	59	6,920	180	5,190	110
2600-240	6	24	3,500	77	3,010	64	1,400	14	3,010	56	5,880	170	4,410	110
2650-130	6.5	13	3,230	77	2,780	64	1,290	14	2,780	56	5,430	170	4,070	110
2680-272	6.8	27.2	3,100	77	2,660	64	1,240	14	2,660	56	5,200	170	3,900	110
2700-280	7	28	3,000	77	2,580	64	1,200	14	2,580	56	5,040	170	3,780	110
2800-320	8	32	2,630	73	2,270	60	1,050	13	2,270	54	4,410	160	3,320	100
2850-340	8.5	34	2,480	73	2,130	60	1,000	13	2,130	54	4,160	160	3,120	100
2860-344	8.6	34.4	2,440	73	2,100	60	980	13	2,100	54	4,100	160	3,080	100
2900-360	9	36	2,330	73	2,010	60	930	13	2,010	54	3,920	160	2,940	100
2950-190	9.5	19	2,210	71	1,900	58	880	12	1,900	53	3,710	150	2,790	100
21000-400	10	40	2,100	69	1,810	57	840	12	1,810	51	3,530	150	2,650	100
21030-412	10.3	41.2	2,050	69	1,760	57	820	12	1,760	51	3,430	150	2,570	100
21100-220	11	22	1,910	67	1,640	55	760	11	1,640	49	3,210	140	2,400	90
21200-480	12	48	1,750	65	1,510	54	700	11	1,510	48	2,940	140	2,210	90

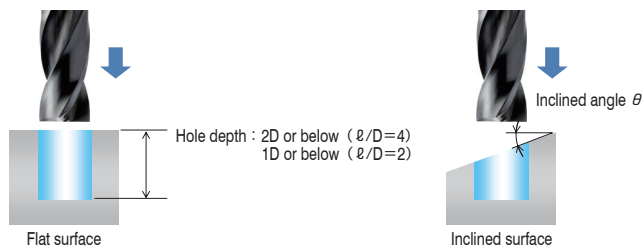

Note:

- These milling parameters are for reference only.
- Adjust the parameters in accordance with the machine rigidity, workpiece clamping condition and shape.
- Recommend water soluble or oil coolant.
- Step milling is recommended in case of clogging.

UTDF Inclined Surface Drilling Example **SS400**
 $\phi 3.5 \times$ Flute Length 14 mm(Prototype)

Work Shape

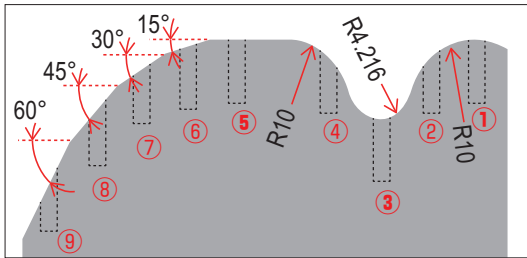

Coolant : Water Soluble (Nozzle)
 Work Size : 40 × 75 × 60 mm

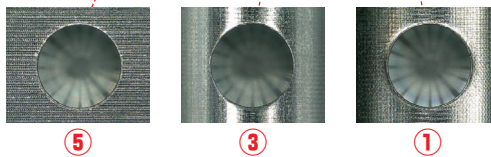
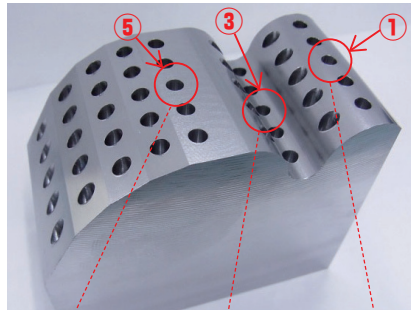

Each hole after drilling

Excellent drilling performance with less burrs.

UTDF
 Inclined Surface
 Drilling Video



Drilling spot	Surface	Spindle Speed (min ⁻¹)	Feed Rate (min/min)	Drilling Depth (The Deepest spot) (mm)
1	凸 Curved surface (Top)	7,000	450	7
2	Curved surface (45°)		270	
3	凹 Curved surface (Top)		450	
4	Curved surface (45°)		270	
5	Flat Surface		450	
6	Inclined Surface (15°)		320	
7	Inclined Surface (30°)		320	
8	Inclined Surface (45°)		270	
9	Inclined Surface (60°)		225	

*Contact our sales for the custom size tool.

Tool After Drilling $\phi 2 \times$ Flute Length 8 mm **A5052**

Surface	Spindle Speed	Feed Rate	Drilling Depth	Number of Holes	Coolant
Flat Surface	23,100 min ⁻¹	830 mm/min	4 mm	100 holes	Water Soluble (Nozzle)

Comparison of Tip Damage after 100 hits

UTDF

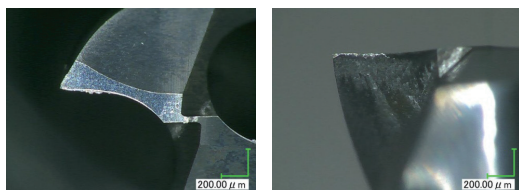

Competitor

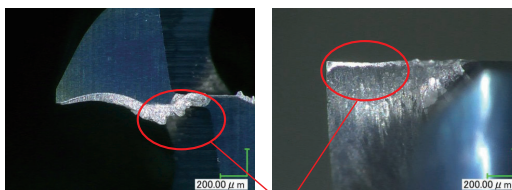

More tool-life left without adhesion after drilling 100 holes.

Chip adhesion

- UDC Series
- CBN Series
- Square
- Long Neck Square
- Radius
- Long Neck Radius
- Taper Neck Radius
- Ball / Long Shank Ball
- Long Neck Ball
- Taper Neck Ball
- Taper
- Spiral V Cutter
- Drill
- EURO Series
- Technical Data



Size $\phi 0.3 \sim \phi 2$

UTDSX



Material Applications (☆ Highly Recommended ○ Recommended ○ Suggested)

Work Material																
STRUCTURAL STEELS SS400	Carbon Steels S45C S55C	Alloy Steels SK / SCM SUS	Prehardened Steels NAK HPM	Hardened Steels			Cast Iron	Aluminum Alloys	Graphite	Copper	Plastics	Glass Filled Plastics	Titanium Alloys	Heat Resistant Alloys	Cemented Carbide	Hard Brittle (Non-Metallic) Materials
				~55HRC	~60HRC	~70HRC										
○	○	○	○	Contact sales when drilling over 45HRC.			○	◎		○			○	○		

Total 35 models

Unit (mm)

Model Number	Diameter ϕD	Flute Length ℓ	Overall Length L	Shank Diameter ϕd	Price ¥
UTDSX 2030-015	0.3	1.5	38	3	3,470
UTDSX 2035-018	0.35	1.8	38	3	3,860
UTDSX 2040-020	0.4	2	38	3	3,470
UTDSX 2045-023	0.45	2.3	38	3	3,860
UTDSX 2050-025	0.5	2.5	38	3	3,860
UTDSX 2055-028	0.55	2.8	38	3	3,070
UTDSX 2060-030	0.6	3	38	3	2,670
UTDSX 2065-033	0.65	3.3	38	3	3,070
UTDSX 2070-035	0.7	3.5	38	3	2,670
UTDSX 2075-038	0.75	3.8	38	3	3,070
UTDSX 2080-040	0.8	4	38	3	2,670
UTDSX 2085-043	0.85	4.3	38	3	3,070
UTDSX 2090-045	0.9	4.5	38	3	2,670
UTDSX 2095-048	0.95	4.8	38	3	3,070
UTDSX 2100-050	1	5	38	3	2,480
UTDSX 2105-053	1.05	5.3	38	3	2,480
UTDSX 2110-055	1.1	5.5	38	3	2,480
UTDSX 2115-058	1.15	5.8	38	3	2,480
UTDSX 2120-060	1.2	6	38	3	2,480
UTDSX 2125-063	1.25	6.3	38	3	2,480
UTDSX 2130-065	1.3	6.5	38	3	2,480
UTDSX 2135-068	1.35	6.8	38	3	2,480
UTDSX 2140-070	1.4	7	38	3	2,480
UTDSX 2145-073	1.45	7.3	38	3	2,480
UTDSX 2150-075	1.5	7.5	38	3	2,480
UTDSX 2155-078	1.55	7.8	38	3	2,480
UTDSX 2160-080	1.6	8	38	3	2,480
UTDSX 2165-083	1.65	8.3	38	3	2,670
UTDSX 2170-085	1.7	8.5	38	3	2,670
UTDSX 2175-088	1.75	8.8	38	3	2,670
UTDSX 2180-090	1.8	9	38	3	2,670
UTDSX 2185-093	1.85	9.3	38	3	2,670
UTDSX 2190-095	1.9	9.5	38	3	2,670
UTDSX 2195-098	1.95	9.8	38	3	2,670
UTDSX 2200-100	2	10	38	3	2,670

Features

A highly efficient and economic drill for both mass and prototype production of parts.
 UT MICRO COAT offers excellent performance for cutting a broad range of materials.
 The new drill design and X thinning geometry offers stable drilling performance with increased tool life.
 The 130° point angle ensures reduced burring of the drilled hole.
 The drill is perfect for high quality drilling applications and for pilot drilling/pre-drilling higher aspect ratio holes.

Diameter Tolerance: 0/-0.01 mm
 Point Angle: 130°

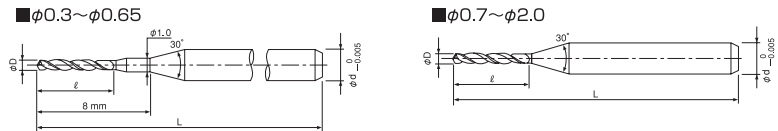

Milling Conditions for UTDSX

WORK MATERIAL	STRUCTURAL STEELS SS400		CARBON STEELS S50C		ALLOY STEELS SCM / SUS		ALUMINUM ALLOYS A5052 / ADC12	
Velocity	Vc=20~35 m/min		Vc=20~35 m/min		Vc=15~20 m/min		Vc=20~60 m/min	
Diameter (mm)	Spindle Speed (min ⁻¹)	Feed Rate (mm/min)	Spindle Speed (min ⁻¹)	Feed Rate (mm/min)	Spindle Speed (min ⁻¹)	Feed Rate (mm/min)	Spindle Speed (min ⁻¹)	Feed Rate (mm/min)
0.3	20,000	100	20,000	100	16,000	80	20,000	200
0.4	17,400	130	17,400	180	12,000	90	20,000	440
0.5	15,900	150	15,900	250	9,500	100	20,000	680
0.6	14,100	170	14,100	300	8,000	110	20,000	920
0.7	12,800	180	12,800	340	6,700	110	20,000	1,160
0.8	11,900	200	11,900	380	6,300	120	20,000	1,400
0.9	10,500	200	10,500	390	6,000	130	17,500	1,430
1	9,500	200	9,500	400	6,000	150	16,000	1,500
1.5	7,300	220	7,300	500	4,500	180	13,000	1,960
2	5,600	230	5,600	560	3,000	160	9,500	2,030
Step Amount	0.3D		0.5D		0.3D		1.0D	

- Note:
- Recommend shallower drilling than flute length (under ϕ 1:1D, ϕ 1 and over: 0.5D).
 - Recommend water soluble or oil coolant.
 - Recommend oil coolant for Titanium Alloys and Heat Resistant Alloys.

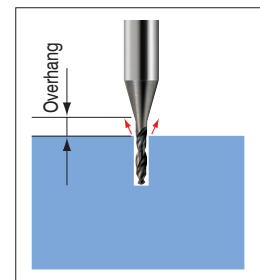

UDC Series

CBN Series

Square
Long Neck Square

Radius

Radius

Long Neck Radius

Taper Neck Radius

Ball / Long Shank Ball

Ball

Long Neck Ball

Taper Neck Ball

Taper

Taper

Spiral V Cutter

Drill

EURO Series

Technical Data



Size $\phi 0.1 \sim \phi 3$

C-UMD



Material Applications (☆ Highly Recommended ● Recommended ○ Suggested)

Work Material															
Carbon Steels S45C S55C	Alloy Steels SK / SCM SUS	Prehardened Steels NAK HPM	Hardened Steels			Cast Iron	Aluminum Alloys	Graphite	Copper	Plastics	Glass Filled Plastics	Titanium Alloys	Heat Resistant Alloys	Cemented Carbide	Hard Brittle (Non-Metallic) Materials
			~55HRC	~60HRC	~70HRC										
○	○	○	Contact sales when drilling over 45HRC.			○	●		○			○	○		

■ $\phi 0.1 \sim \phi 0.25$

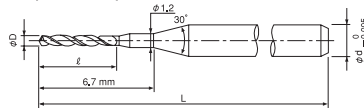

■ $\phi 0.26 \sim \phi 0.65$

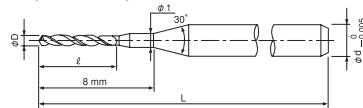

■ $\phi 0.66 \sim \phi 3$

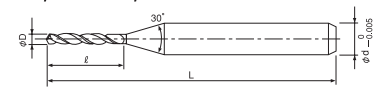

Actual tool geometries for some specifications and tolerances may differ from above drawings. $\phi 3$ is Straight type.

Diameter Tolerance : $\phi D \leq \phi 3$: $\phi D \begin{smallmatrix} 0 \\ -0.01 \end{smallmatrix}$
 Point Angle : 150°

Total 225 models

Unit (mm)

Model Number	Diameter ϕD	Flute Length ℓ	Overall Length L	Shank Diameter ϕd	Price ¥
C-UMD 2010-012	0.1	1.2	38	3	5,500
C-UMD 2011-012	0.11	1.2	38	3	6,050
C-UMD 2012-014	0.12	1.4	38	3	6,050
C-UMD 2013-014	0.13	1.4	38	3	6,050
C-UMD 2014-014	0.14	1.4	38	3	6,050
C-UMD 2015-020	0.15	2	38	3	5,060
C-UMD 2016-020	0.16	2	38	3	5,390
C-UMD 2017-020	0.17	2	38	3	5,390
C-UMD 2018-020	0.18	2	38	3	5,390
C-UMD 2019-020	0.19	2	38	3	5,390
C-UMD 2020-025	0.2	2.5	38	3	4,400
C-UMD 2021-025	0.21	2.5	38	3	4,950
C-UMD 2022-025	0.22	2.5	38	3	4,950
C-UMD 2023-025	0.23	2.5	38	3	4,950
C-UMD 2024-025	0.24	2.5	38	3	4,950
C-UMD 2025-030	0.25	3	38	3	4,950
C-UMD 2026-030	0.26	3	38	3	4,730
C-UMD 2027-030	0.27	3	38	3	4,730
C-UMD 2028-030	0.28	3	38	3	4,730
C-UMD 2029-030	0.29	3	38	3	4,730
C-UMD 2030-050	0.3	5	38	3	3,850
C-UMD 2031-050	0.31	5	38	3	4,730
C-UMD 2032-050	0.32	5	38	3	4,730
C-UMD 2033-050	0.33	5	38	3	4,730

Unit (mm)

Model Number	Diameter ϕD	Flute Length ℓ	Overall Length L	Shank Diameter ϕd	Price ¥
C-UMD 2034-050	0.34	5	38	3	4,730
C-UMD 2035-060	0.35	6	38	3	4,290
C-UMD 2036-060	0.36	6	38	3	4,730
C-UMD 2037-060	0.37	6	38	3	4,730
C-UMD 2038-060	0.38	6	38	3	4,730
C-UMD 2039-060	0.39	6	38	3	4,730
C-UMD 2040-070	0.4	7	38	3	3,850
C-UMD 2041-070	0.41	7	38	3	4,730
C-UMD 2042-070	0.42	7	38	3	4,730
C-UMD 2043-070	0.43	7	38	3	4,730
C-UMD 2044-070	0.44	7	38	3	4,730
C-UMD 2045-070	0.45	7	38	3	4,290
C-UMD 2046-070	0.46	7	38	3	4,730
C-UMD 2047-070	0.47	7	38	3	4,730
C-UMD 2048-070	0.48	7	38	3	4,730
C-UMD 2049-070	0.49	7	38	3	4,730
C-UMD 2050-070	0.5	7	38	3	4,290
C-UMD 2051-070	0.51	7	38	3	4,290
C-UMD 2052-070	0.52	7	38	3	4,290
C-UMD 2053-070	0.53	7	38	3	4,290
C-UMD 2054-070	0.54	7	38	3	4,290
C-UMD 2055-070	0.55	7	38	3	3,410
C-UMD 2056-070	0.56	7	38	3	4,290
C-UMD 2057-070	0.57	7	38	3	4,290

Next Page ➔

Unit (mm)

Model Number	Diameter ϕD	Flute Length ℓ	Overall Length L	Shank Diameter ϕd	Price ¥
C-UMD 2058-070	0.58	7	38	3	4,290
C-UMD 2059-070	0.59	7	38	3	4,290
C-UMD 2060-070	0.6	7	38	3	2,970
C-UMD 2061-070	0.61	7	38	3	4,290
C-UMD 2062-070	0.62	7	38	3	4,290
C-UMD 2063-070	0.63	7	38	3	4,290
C-UMD 2064-070	0.64	7	38	3	4,290
C-UMD 2065-070	0.65	7	38	3	3,410
C-UMD 2066-070	0.66	7	38	3	4,290
C-UMD 2067-070	0.67	7	38	3	4,290
C-UMD 2068-070	0.68	7	38	3	4,290
C-UMD 2069-070	0.69	7	38	3	4,290
C-UMD 2070-080	0.7	8	38	3	2,970
C-UMD 2071-080	0.71	8	38	3	4,290
C-UMD 2072-080	0.72	8	38	3	4,290
C-UMD 2073-080	0.73	8	38	3	4,290
C-UMD 2074-080	0.74	8	38	3	4,290
C-UMD 2075-080	0.75	8	38	3	3,410
C-UMD 2076-080	0.76	8	38	3	4,290
C-UMD 2077-080	0.77	8	38	3	4,290
C-UMD 2078-080	0.78	8	38	3	4,290
C-UMD 2079-080	0.79	8	38	3	4,290
C-UMD 2080-100	0.8	10	38	3	2,970
C-UMD 2081-100	0.81	10	38	3	4,290
C-UMD 2082-100	0.82	10	38	3	4,290
C-UMD 2083-100	0.83	10	38	3	4,290
C-UMD 2084-100	0.84	10	38	3	4,290
C-UMD 2085-100	0.85	10	38	3	3,410
C-UMD 2086-100	0.86	10	38	3	4,290
C-UMD 2087-100	0.87	10	38	3	4,290
C-UMD 2088-100	0.88	10	38	3	4,290
C-UMD 2089-100	0.89	10	38	3	4,290
C-UMD 2090-100	0.9	10	38	3	2,970
C-UMD 2091-100	0.91	10	38	3	4,290
C-UMD 2092-100	0.92	10	38	3	4,290
C-UMD 2093-100	0.93	10	38	3	4,290
C-UMD 2094-100	0.94	10	38	3	4,290
C-UMD 2095-100	0.95	10	38	3	3,410
C-UMD 2096-100	0.96	10	38	3	4,290
C-UMD 2097-100	0.97	10	38	3	4,290
C-UMD 2098-100	0.98	10	38	3	4,290
C-UMD 2099-100	0.99	10	38	3	4,290
C-UMD 2100-100	1	10	38	3	2,750
C-UMD 2101-100	1.01	10	38	3	3,410
C-UMD 2102-100	1.02	10	38	3	3,410
C-UMD 2103-100	1.03	10	38	3	3,410

Unit (mm)

Model Number	Diameter ϕD	Flute Length ℓ	Overall Length L	Shank Diameter ϕd	Price ¥
C-UMD 2104-100	1.04	10	38	3	3,410
C-UMD 2105-100	1.05	10	38	3	2,750
C-UMD 2106-100	1.06	10	38	3	3,410
C-UMD 2107-100	1.07	10	38	3	3,410
C-UMD 2108-100	1.08	10	38	3	3,410
C-UMD 2109-100	1.09	10	38	3	3,410
C-UMD 2110-100	1.1	10	38	3	2,750
C-UMD 2111-100	1.11	10	38	3	3,410
C-UMD 2112-100	1.12	10	38	3	3,410
C-UMD 2113-100	1.13	10	38	3	3,410
C-UMD 2114-100	1.14	10	38	3	3,410
C-UMD 2115-100	1.15	10	38	3	2,750
C-UMD 2116-100	1.16	10	38	3	3,410
C-UMD 2117-100	1.17	10	38	3	3,410
C-UMD 2118-100	1.18	10	38	3	3,410
C-UMD 2119-100	1.19	10	38	3	3,410
C-UMD 2120-100	1.2	10	38	3	2,750
C-UMD 2121-100	1.21	10	38	3	3,410
C-UMD 2122-100	1.22	10	38	3	3,410
C-UMD 2123-100	1.23	10	38	3	3,410
C-UMD 2124-100	1.24	10	38	3	3,410
C-UMD 2125-100	1.25	10	38	3	2,750
C-UMD 2126-100	1.26	10	38	3	3,410
C-UMD 2127-100	1.27	10	38	3	3,410
C-UMD 2128-100	1.28	10	38	3	3,410
C-UMD 2129-100	1.29	10	38	3	3,410
C-UMD 2130-100	1.3	10	38	3	2,750
C-UMD 2131-100	1.31	10	38	3	3,410
C-UMD 2132-100	1.32	10	38	3	3,410
C-UMD 2133-100	1.33	10	38	3	3,410
C-UMD 2134-100	1.34	10	38	3	3,410
C-UMD 2135-100	1.35	10	38	3	2,750
C-UMD 2136-100	1.36	10	38	3	3,410
C-UMD 2137-100	1.37	10	38	3	3,410
C-UMD 2138-100	1.38	10	38	3	3,410
C-UMD 2139-100	1.39	10	38	3	3,410
C-UMD 2140-100	1.4	10	38	3	2,750
C-UMD 2141-100	1.41	10	38	3	3,410
C-UMD 2142-100	1.42	10	38	3	3,410
C-UMD 2143-100	1.43	10	38	3	3,410
C-UMD 2144-100	1.44	10	38	3	3,410
C-UMD 2145-100	1.45	10	38	3	2,750
C-UMD 2146-100	1.46	10	38	3	3,410
C-UMD 2147-100	1.47	10	38	3	3,410
C-UMD 2148-100	1.48	10	38	3	3,410
C-UMD 2149-100	1.49	10	38	3	3,410

UDC Series

CBN Series

Square

Square

Long Neck Square

Radius

Radius

Long Neck Radius

Taper Neck Radius

Ball / Long Shank Ball

Ball

Long Neck Ball

Taper Neck Ball

Taper

Spiral V Cutter

Drill

EURO Series

Technical Data

Next Page ➡

Unit (mm)

Model Number	Diameter ϕD	Flute Length ℓ	Overall Length L	Shank Diameter ϕd	Price ¥
C-UMD 2150-100	1.5	10	38	3	2,750
C-UMD 2151-100	1.51	10	38	3	3,410
C-UMD 2152-100	1.52	10	38	3	3,410
C-UMD 2153-100	1.53	10	38	3	3,410
C-UMD 2154-100	1.54	10	38	3	3,410
C-UMD 2155-100	1.55	10	38	3	2,750
C-UMD 2156-100	1.56	10	38	3	3,410
C-UMD 2157-100	1.57	10	38	3	3,410
C-UMD 2158-100	1.58	10	38	3	3,410
C-UMD 2159-100	1.59	10	38	3	3,410
C-UMD 2160-120	1.6	12	38	3	2,750
C-UMD 2161-120	1.61	12	38	3	3,630
C-UMD 2162-120	1.62	12	38	3	3,630
C-UMD 2163-120	1.63	12	38	3	3,630
C-UMD 2164-120	1.64	12	38	3	3,630
C-UMD 2165-120	1.65	12	38	3	2,970
C-UMD 2166-120	1.66	12	38	3	3,630
C-UMD 2167-120	1.67	12	38	3	3,630
C-UMD 2168-120	1.68	12	38	3	3,630
C-UMD 2169-120	1.69	12	38	3	3,630
C-UMD 2170-120	1.7	12	38	3	2,970
C-UMD 2171-120	1.71	12	38	3	3,630
C-UMD 2172-120	1.72	12	38	3	3,630
C-UMD 2173-120	1.73	12	38	3	3,630
C-UMD 2174-120	1.74	12	38	3	3,630
C-UMD 2175-120	1.75	12	38	3	2,970
C-UMD 2176-120	1.76	12	38	3	3,630
C-UMD 2177-120	1.77	12	38	3	3,630
C-UMD 2178-120	1.78	12	38	3	3,630
C-UMD 2179-120	1.79	12	38	3	3,630
C-UMD 2180-120	1.8	12	38	3	2,970
C-UMD 2181-120	1.81	12	38	3	3,630
C-UMD 2182-120	1.82	12	38	3	3,630
C-UMD 2183-120	1.83	12	38	3	3,630
C-UMD 2184-120	1.84	12	38	3	3,630
C-UMD 2185-120	1.85	12	38	3	2,970
C-UMD 2186-120	1.86	12	38	3	3,630
C-UMD 2187-120	1.87	12	38	3	3,630
C-UMD 2188-120	1.88	12	38	3	3,630
C-UMD 2189-120	1.89	12	38	3	3,630
C-UMD 2190-120	1.9	12	38	3	2,970
C-UMD 2191-120	1.91	12	38	3	3,630
C-UMD 2192-120	1.92	12	38	3	3,630

Unit (mm)

Model Number	Diameter ϕD	Flute Length ℓ	Overall Length L	Shank Diameter ϕd	Price ¥
C-UMD 2193-120	1.93	12	38	3	3,630
C-UMD 2194-120	1.94	12	38	3	3,630
C-UMD 2195-120	1.95	12	38	3	2,970
C-UMD 2196-120	1.96	12	38	3	3,630
C-UMD 2197-120	1.97	12	38	3	3,630
C-UMD 2198-120	1.98	12	38	3	3,630
C-UMD 2199-120	1.99	12	38	3	3,630
C-UMD 2200-120	2	12	38	3	2,970
C-UMD 2205-120	2.05	12	38	3	3,850
C-UMD 2210-120	2.1	12	38	3	3,190
C-UMD 2212-120	2.12	12	38	3	3,190
C-UMD 2213-120	2.13	12	38	3	3,190
C-UMD 2214-120	2.14	12	38	3	3,190
C-UMD 2215-120	2.15	12	38	3	3,850
C-UMD 2220-120	2.2	12	38	3	3,190
C-UMD 2225-120	2.25	12	38	3	3,850
C-UMD 2229-120	2.29	12	38	3	3,190
C-UMD 2230-120	2.3	12	38	3	3,190
C-UMD 2231-120	2.31	12	38	3	3,190
C-UMD 2232-120	2.32	12	38	3	3,190
C-UMD 2235-120	2.35	12	38	3	3,850
C-UMD 2239-120	2.39	12	38	3	3,190
C-UMD 2240-120	2.4	12	38	3	3,190
C-UMD 2241-120	2.41	12	38	3	3,190
C-UMD 2242-120	2.42	12	38	3	3,190
C-UMD 2245-120	2.45	12	38	3	3,850
C-UMD 2250-120	2.5	12	38	3	3,190
C-UMD 2255-120	2.55	12	38	3	3,850
C-UMD 2256-120	2.56	12	38	3	3,190
C-UMD 2257-120	2.57	12	38	3	3,190
C-UMD 2260-120	2.6	12	38	3	3,190
C-UMD 2265-120	2.65	12	38	3	3,850
C-UMD 2270-120	2.7	12	38	3	3,190
C-UMD 2275-120	2.75	12	38	3	3,850
C-UMD 2277-120	2.77	12	38	3	3,190
C-UMD 2278-120	2.78	12	38	3	3,190
C-UMD 2279-120	2.79	12	38	3	3,190
C-UMD 2280-120	2.8	12	38	3	3,190
C-UMD 2285-120	2.85	12	38	3	3,850
C-UMD 2290-120	2.9	12	38	3	3,190
C-UMD 2295-120	2.95	12	38	3	3,850
C-UMD 2300-120	3	12	38	3	3,190

UDC Series

CBN Series

Square
Long Neck Square

Radius
Long Neck Radius
Taper Neck Radius

Ball / Long Shank Ball
Long Neck Ball
Taper Neck Ball

Taper

Spiral V Cutter

Drill

EURO Series

Technical Data

Milling Conditions for C-UMD

WORK MATERIAL	CARBON STEELS S45C / S50C (~225HB)		ALLOY STEELS SK / SCM / SUS (225~325HB)		PREHARDENED STEELS HARDENED STEELS NAK / SKD (30~45HRC)		ALUMINUM ALLOYS A5052	
Velocity	Vc=25~40 m/min		Vc=15~25 m/min		Vc=10~15 m/min		Vc=20~60 m/min	
Diameter (mm)	Spindle Speed (min ⁻¹)	Feed Rate (mm/min)	Spindle Speed (min ⁻¹)	Feed Rate (mm/min)	Spindle Speed (min ⁻¹)	Feed Rate (mm/min)	Spindle Speed (min ⁻¹)	Feed Rate (mm/min)
0.3	20,000	40	15,900	30	10,600	10	20,000	400
0.4	17,400	50	11,800	40	8,000	20	19,900	690
0.5	15,900	80	9,500	50	6,400	30	20,000	1,000
0.6	14,100	80	7,900	40	5,300	20	19,900	1,050
0.7	12,800	90	6,800	50	4,500	20	19,900	1,120
0.8	11,900	100	6,000	50	4,000	20	19,900	1,190
0.9	10,500	100	6,200	50	3,500	20	17,600	1,220
1	9,500	100	6,400	60	3,200	20	15,900	1,270
2	5,600	170	3,200	100	1,600	20	9,500	950
3	3,700	150	2,700	110	1,600	20	6,400	640

Note:

- Recommend step amount 0.1D-0.2D. Recommend 0.2D-0.5D for Aluminum Alloys.
- Recommend water soluble or oil coolant.
- Recommend oil coolant for Titanium Alloys and Heat Resistant Alloys.

UDC Series

CBN Series

Square
Long Neck Square

Radius

Long Neck Radius

Taper Neck Radius

Ball / Long Shank Ball

Ball
Long Neck Ball
Taper Neck BallTaper
Taper

Spiral V Cutter

Drill

EURO Series

Technical Data

Drilling Example 1

SUS304

Comments

● Tip Damage:

Damage by chipping can be seen on the Carbide Drill. The High-Speed Steel Drill exhibits wear on the top chisel line and corners. The High Speed drill also has the work material adhering to it.

● Hole Position:

The solid carbide drill has minimal deflection when compared to a High Speed steel model, through the entire drilling cycle.

Drilling Condition

Tool: ϕ 0.6 × Flute Length 7mm
 Work Material: SUS304 (1.4301)
 Spindle Speed: 8,000 min⁻¹
 Velocity: 15 m/min
 Z Feed Rate: 50 mm/min
 Chip Load: 0.00625 mm/rev
 Peck Amount: 0.12 mm/time
 Hole Depth: 2.4 mm
 Number of Holes: 500 holes
 Drilling Time: 25 min/100 holes
 Overhang Length: 10 mm
 Coolant: Water Soluble (Nozzle)

Process Form

* Blind Hole Step Process

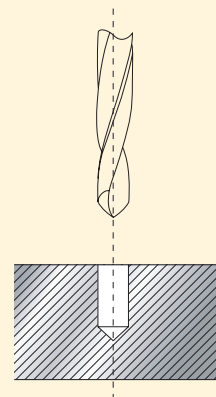

Comparison of Tip Damage

	Before use	After 250 hits	After 500 hits
UT C-UMD2060-070 ϕ 0.6 Flute Length 7 mm Ti-Composite Membrane			
Company A High Speed Steel Drill ϕ 0.6 Flute Length 7 mm TiN			

UDC Series

CBN Series

Square

Long Neck Square

Radius

Long Neck Radius

Taper Neck Radius

Ball / Long Shark Ball

Long Neck Ball

Taper Neck Ball

Taper

Spiral V Cutter

Drill

EURO Series

Technical Data

Comparison of Hole Position

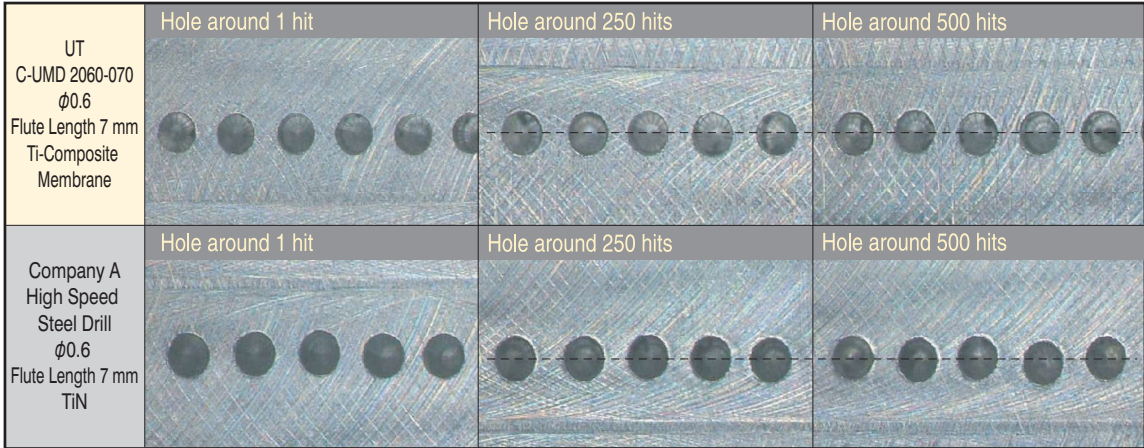

Drilling Example 2

SUS304

φ0.1 Drilling (about 800 holes)

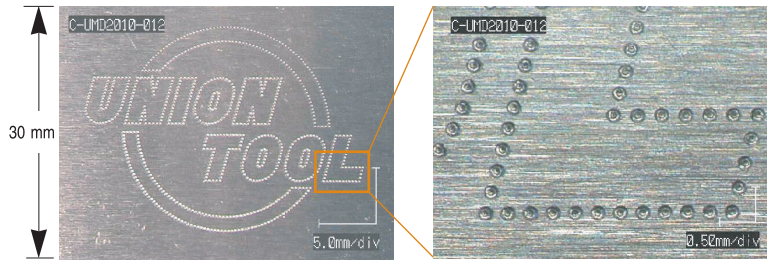

	Spindle Speed (min ⁻¹)	Feed Rate (mm/min)	Peck Amount (mm/time)	Hole Depth (mm)	Drilling Time	Coolant	Note
Acrylic φ0.1							
C-UMD φ 0.1	20,000	20	0.02	1.00	1 h 30 min	Air Blow	Direct + Drilling
SUS304 (1.4301) φ0.1							
Center Drill+Chamfering C-UMD φ 0.2	10,000	2	0.01	0.05	2 h 50 min	Water Soluble	
Drilling C-UMD φ 0.1	12,000	4	0.02	0.20	3 h 27 min	Water Soluble	
Aluminum (A5052) φ0.2							
C-UMD φ 0.2	16,000	80	0.04	1.50	2 h 50 min	Water Soluble	Using back-up board
NAK55 (AISI P21) φ0.3							
C-UMD φ 0.3	15,000	15	0.06	1.50	3 h 35 min	Water Soluble	Using Center Drill
SUS304 (1.4301) φ0.3							
C-UMD φ 0.3	16,000	30	0.06	1.50	2 h 24 min	Water Soluble	Using Center Drill

UDC Series

CBN Series

Square
Long Neck Square

Radius

Long Neck Radius

Taper Neck Radius

Ball / Long Shank Ball

Long Neck Ball

Taper Neck Ball

Taper

Spiral V Cutter

Drill

EURO Series

Technical Data



Size $\phi 0.3 \sim \phi 3$

UTDLX



Material Applications (☆ Highly Recommended ○ Recommended ○ Suggested)

Work Material																
STRUCTURAL STEELS SS400	Carbon Steels S45C S55C	Alloy Steels SK / SCM SUS	Prehardened Steels NAK HPM	Hardened Steels			Cast Iron	Aluminum Alloys	Graphite	Copper	Plastics	Glass Filled Plastics	Titanium Alloys	Heat Resistant Alloys	Cemented Carbide	Hard Brittle (Non-Metallic) Materials
				~55HRC	~60HRC	~70HRC										
○	○	○	○	Contact sales when drilling over 45HRC.			○	○		○			○	○		

Features

A highly efficient and economic drill for both mass and prototype production of parts. UT MICRO COAT offers excellent performance for cutting a broad range of materials. The new drill design and geometry offers stable drilling performance with increased tool life. The 130° point angle ensures reduced burring of the drilled hole. With an aspect ratio of 15:1, the drill is ideal for deep hole drilling, that requires high accuracy.

Diameter Tolerance: 0/-0.01 mm
Point Angle: 130°

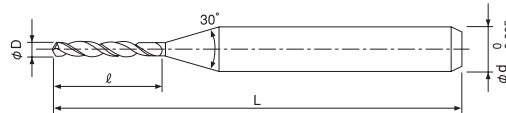

Total 55 models

Unit (mm)

Model Number	Diameter ϕD	Flute Length l	Overall Length L	Shank Diameter ϕd	Price ¥
UTDLX 2030-045	0.3	4.5	38	3	4,600
UTDLX 2035-053	0.35	5.3	38	3	5,130
UTDLX 2040-060	0.4	6	38	3	4,600
UTDLX 2045-068	0.45	6.8	38	3	5,130
UTDLX 2050-075	0.5	7.5	38	3	4,600
UTDLX 2055-083	0.55	8.3	38	3	5,130
UTDLX 2060-090	0.6	9	45	3	4,600
UTDLX 2065-098	0.65	9.8	45	3	5,290
UTDLX 2070-105	0.7	10.5	45	3	4,600
UTDLX 2075-113	0.75	11.3	45	3	5,290
UTDLX 2080-120	0.8	12	45	3	4,600
UTDLX 2085-128	0.85	12.8	45	3	5,290

Next Page ➡

Unit (mm)

Model Number	Diameter ϕD	Flute Length ℓ	Overall Length L	Shank Diameter ϕd	Price ¥
UTDLX 2090-135	0.9	13.5	45	3	4,600
UTDLX 2095-143	0.95	14.3	45	3	5,290
UTDLX 2100-150	1	15	50	3	4,600
UTDLX 2105-158	1.05	15.8	50	3	4,600
UTDLX 2110-165	1.1	16.5	50	3	4,600
UTDLX 2115-173	1.15	17.3	50	3	4,600
UTDLX 2120-180	1.2	18	50	3	4,600
UTDLX 2125-188	1.25	18.8	50	3	4,600
UTDLX 2130-195	1.3	19.5	50	3	4,600
UTDLX 2135-203	1.35	20.3	60	3	4,600
UTDLX 2140-210	1.4	21	60	3	4,600
UTDLX 2145-218	1.45	21.8	60	3	4,600
UTDLX 2150-225	1.5	22.5	60	3	4,600
UTDLX 2155-233	1.55	23.3	60	3	4,600
UTDLX 2160-240	1.6	24	60	3	4,600
UTDLX 2165-248	1.65	24.8	60	3	4,970
UTDLX 2170-255	1.7	25.5	60	3	4,970
UTDLX 2175-263	1.75	26.3	60	3	4,970
UTDLX 2180-270	1.8	27	60	3	4,970
UTDLX 2185-278	1.85	27.8	60	3	4,970
UTDLX 2190-285	1.9	28.5	60	3	4,970
UTDLX 2195-293	1.95	29.3	60	3	4,970
UTDLX 2200-300	2	30	60	3	4,970
UTDLX 2205-308	2.05	30.8	80	3	6,640
UTDLX 2210-315	2.1	31.5	80	3	5,500
UTDLX 2215-323	2.15	32.3	80	3	6,640
UTDLX 2220-330	2.2	33	80	3	5,500
UTDLX 2225-338	2.25	33.8	80	3	6,640
UTDLX 2230-345	2.3	34.5	80	3	5,500
UTDLX 2235-353	2.35	35.3	80	3	6,640
UTDLX 2240-360	2.4	36	80	3	5,500
UTDLX 2245-368	2.45	36.8	80	3	6,640
UTDLX 2250-375	2.5	37.5	80	3	5,500
UTDLX 2255-383	2.55	38.3	80	3	6,640
UTDLX 2260-390	2.6	39	80	3	5,500
UTDLX 2265-398	2.65	39.8	80	3	6,640
UTDLX 2270-405	2.7	40.5	80	3	5,500
UTDLX 2275-413	2.75	41.3	80	3	6,640
UTDLX 2280-420	2.8	42	80	3	5,500
UTDLX 2285-428	2.85	42.8	80	3	6,640
UTDLX 2290-435	2.9	43.5	80	3	5,500
UTDLX 2295-443	2.95	44.3	80	3	6,640
UTDLX 2300-450	3	45	80	3	5,500

UDC
SeriesCBN
SeriesSquare
Long Neck
SquareRadius
Long Neck
RadiusTaper Neck
RadiusBall / Long
Shank Ball
Long Neck
BallTaper Neck
Ball

Taper

Spiral
V Cutter

Drill

EURO Series

Technical Data

Milling Conditions for UTDLX

WORK MATERIAL	STRUCTURAL STEELS SS400		CARBON STEELS S50C		ALLOY STEELS SCM / SUS		ALUMINUM ALLOYS A5052	
Velocity	Vc=20~40 m/min		Vc=20~40 m/min		Vc=15~40 m/min		Vc=25~60 m/min	
Diameter (mm)	Spindle Speed (min ⁻¹)	Feed Rate (mm/min)	Spindle Speed (min ⁻¹)	Feed Rate (mm/min)	Spindle Speed (min ⁻¹)	Feed Rate (mm/min)	Spindle Speed (min ⁻¹)	Feed Rate (mm/min)
0.3	20,000	50	20,000	50	16,000	40	20,000	650
0.35	19,000	60	19,000	60	13,600	50	20,000	700
0.4	18,000	80	18,000	80	11,900	50	20,000	800
0.45	17,000	100	17,000	100	10,600	60	20,000	850
0.5	16,000	120	16,000	120	9,500	60	20,000	920
0.55	15,000	140	15,000	140	9,000	70	20,000	1,050
0.6	14,100	140	14,100	140	7,900	70	19,900	1,150
0.7	12,800	140	12,800	140	6,800	70	19,900	1,230
0.8	11,900	140	11,900	140	6,000	70	19,900	1,310
0.9	10,500	140	10,500	140	6,200	70	17,600	1,350
1	9,500	150	9,500	150	6,400	70	15,900	1,400
1.5	7,200	150	7,200	150	5,500	70	12,000	1,470
2	5,600	150	5,600	150	5,000	70	9,500	1,590
2.5	4,500	150	4,500	150	4,400	70	7,600	1,640
3	4,000	150	4,000	150	3,800	70	6,400	1,700
Peck Amount	0.5D		0.3D		0.1D		0.3D	

Note:

- Apply pre-drilling more than 3D depth before deep drilling. Recommend UTDSX for pre-drilling.
- Recommend shallower drilling than flute length (under ϕ 1:1D, ϕ 1 and over: 0.5D).
- Recommend water soluble or oil coolant.
- Recommend oil coolant for Titanium Alloys and Heat Resistant Alloys.

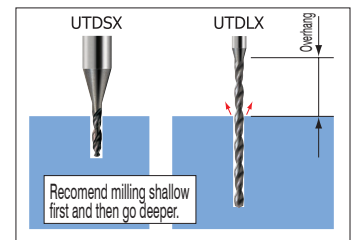

UDC Series

CBN Series

Square
Long Neck Square

Radius
Long Neck Radius
Taper Neck Radius

Ball / Long Shank Ball
Long Neck Ball

Taper Neck Ball

Taper

Spiral V Cutter

Drill

EURO Series

Technical Data

SUS420J2 (Raw Material) Comparison of UTD (Carbide) and HSS Drill Bit

UTD can drill more than 2X holes compared to an HSS model

Tool Size	φ1.32 × 12 UTD proto type
Spindle Speed	5,000 min ⁻¹ (Vc: 21 m/min)
Feed Rate	200 mm/min (f: 0.04 mm/rev.)
Peck Amount	1.3 mm
Depth	7 mm blind hole

UTD prototype

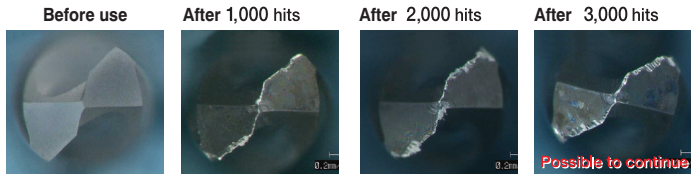

HSS Drill (Company A: φ3 shank diameter with TIN coating for SUS)

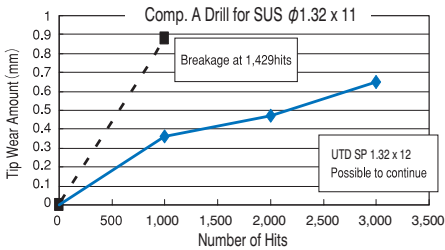

Flank wear comparison with HSS

Drilling test with various materials (Comparison of with / without thinning)

Smooth chip evacuation using the X-thinning design, offers greater resistance to breakage and more accurate drilling

Drill Size : φ1.0 x 15
 Tool : UTDLX 2100-150 (with thinning)
 Test Tool: φ1.0 x 15 (without thinning)

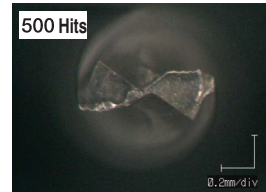
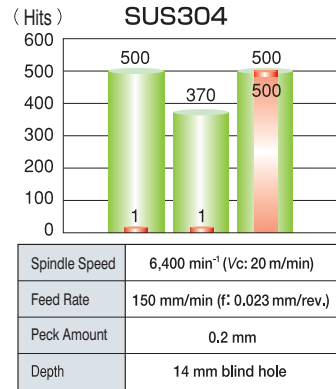
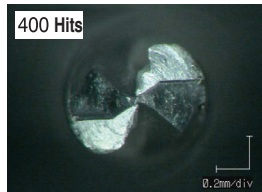
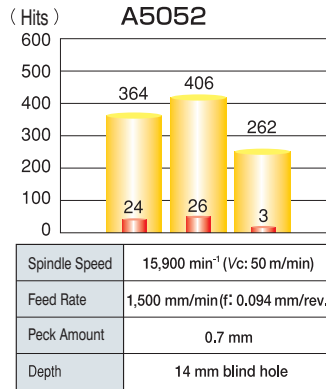
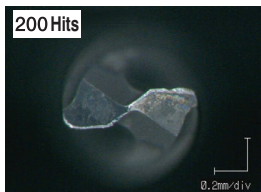
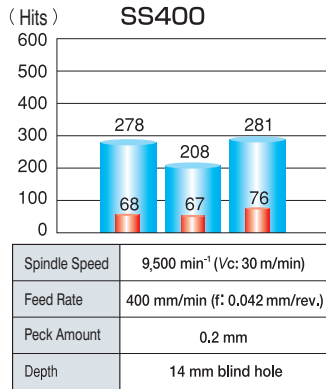
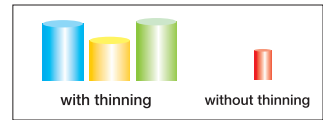





- UDC Series
- CBN Series
- Square
- Long Neck Square
- Radius
- Long Neck Radius
- Taper Neck Radius
- Ball / Long Shank Ball
- Long Neck Ball
- Taper Neck Ball
- Taper
- Spiral V Cutter
- Drill
- EURO Series
- Technical Data

UNIMAX EURO Series

★ What is EURO Series?

The EURO series was designed for the European market and has proved very successful with a wide range of users. It is also popular with European machine OEM's, CAM system companies and toolholder makers.

Introducing EURO Series

	Features	Coating	Flute Shape	Outside Diameter	Page
Radius / Long Neck Radius for Aluminum and Plastics					
CPRS25NSP					
2 Flutes 	<ul style="list-style-type: none"> Recommend for milling Aluminum Alloys and Plastics All models adopt a corner radius of R0.1 in order to prevent chipping 	NON-COAT	Positive Rake Design	$\phi 2$ $\sim \phi 12$	564
Long Neck Radius for Aluminum and Plastics					
CPRS30N					
2 Flutes 	<ul style="list-style-type: none"> Recommend for milling Aluminum Alloys and Plastics Designed for finishing applications 	NON-COAT	Positive Rake Design	$\phi 4$ $\sim \phi 10$	566
Long Neck Radius					
CRS40HSP					
3 Flutes 	<ul style="list-style-type: none"> Helix angle 40° Broad application range from SUS up to Hardened Steels (60HRC) 	HARDMAX	Positive Rake Design	$\phi 2$ $\sim \phi 12$	568
Long Neck Radius					
CRS20HSP					
4 Flutes 	<ul style="list-style-type: none"> Recommend for milling Hardened Steels and Cast Iron Helix angle 20° 	HARDMAX	Negative Rake Design	$\phi 2$ $\sim \phi 12$	570

UDC Series

CBN Series

Square
Long Neck Square

Radius
Long Neck Radius

Taper Neck Radius

Ball / Long Shank Ball

Ball
Long Neck Ball
Taper Neck Ball

Taper
Taper

Spiral V Cutter

Drill

EURO Series

Technical Data



Size $\phi 2 \sim \phi 12$

CPRS25NSP



Material Applications (☆ Highly Recommended ○ Recommended ○ Suggested)

Work Material															
Carbon Steels S45C S55C	Alloy Steels SK / SCM SUS	Prehardened Steels NAK HPM	Hardened Steels			Cast Iron	Aluminum Alloys	Graphite	Copper	Plastics	Glass Filled Plastics	Titanium Alloys	Heat Resistant Alloys	Cemented Carbide	Hard Brittle (Non-Metallic) Materials
			~55HRC	~60HRC	~70HRC										
							○		○	○					

Features

Non-coated Radius and Long Neck Radius for Aluminum Alloys and Plastics.
All models adopt a corner radius of R0.1 in order to prevent chipping.

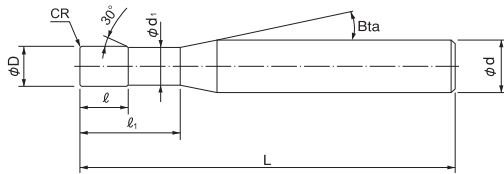

The shank taper angle shown is not an exact value and to avoid contact with the work piece, we recommend the user controls the precise value of this angle. Shank taper angle should not make contact with the work piece.

Total 10 models

Unit (mm)

Model Number	Outside Diameter ϕD	Corner Radius CR	Effective Length ℓ_1	Length of Cut ℓ	Neck Diameter ϕd_1	Shank Taper Angle Bta	Overall Length L	Shank Diameter ϕd	Price ¥
CPRS25NSP 2020-010-06	2	RO.1	6	3	1.92	16°	38	3	7,300
CPRS25NSP 2030-010-08	3	RO.1	8	4	2.93	—	38	3	7,300
CPRS25NSP 2040-010-12	4	RO.1	12	5	3.83	—	50	4	8,800
CPRS25NSP 2050-010-14	5	RO.1	14	8	4.83	16°	50	6	14,200
CPRS25NSP 2060-010	6	RO.1	No Undercut	13	—	—	50	6	11,200
CPRS25NSP 2060-010-18			18	8	5.73		65	6	12,900
CPRS25NSP 2080-010	8	RO.1	No Undercut	13	—	—	50	8	16,200
CPRS25NSP 2080-010-22			22	10	7.82		80	8	17,800
CPRS25NSP 2100-010-28	10	RO.1	28	14	9.82	—	80	10	23,000
CPRS25NSP 2120-010-35	12	RO.1	35	16	11.82	—	90	12	29,000

Milling Conditions for CPRS25NSP (2 Flutes)

◆ Under cut type

WORK MATERIAL		PLASTICS			ALUMINUM ALLOYS		
Model Number	Outside Diameter (mm)	Spindle Speed (min ⁻¹)	Feed Rate (Slotting) (mm/min)	Feed Rate (Side milling) (mm/min)	Spindle Speed (min ⁻¹)	Feed Rate (Slotting) (mm/min)	Feed Rate (Side milling) (mm/min)
2020-010-06	2	12,800	510	765	23,900	480	720
2030-010-08	3	12,800	640	960	16,000	580	870
2040-010-12	4	12,000	600	900	12,000	615	920
2050-010-14	5	9,600	480	720	9,600	640	960
2060-010-18	6	8,000	400	600	8,000	690	1,040
2080-010-22	8	6,000	300	450	6,000	735	1,100
2100-010-28	10	4,800	240	360	4,800	825	1,240
2120-010-35	12	4,000	200	300	4,000	850	1,280

◆ Straight type

WORK MATERIAL		PLASTICS			ALUMINUM ALLOYS		
Model Number	Outside Diameter (mm)	Spindle Speed (min ⁻¹)	Feed Rate (Slotting) (mm/min)	Feed Rate (Side milling) (mm/min)	Spindle Speed (min ⁻¹)	Feed Rate (Slotting) (mm/min)	Feed Rate (Side milling) (mm/min)
2060-010	6	8,000	400	600	8,000	690	1,040
2080-010	8	6,000	300	450	6,000	735	1,100

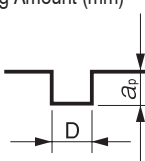
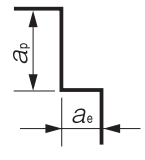
Slotting Milling Amount (mm) 	Roughing	$a_p = 0.5D$	$D \leq 2 \quad a_p = 0.2D$ $D \geq 3 \quad a_p = 0.5D$	
	Finishing	$a_p = 0.03D$	$a_p = 0.05D$	
Side Milling Milling Amount (mm) 	Roughing	$a_p = 1.0D$ $a_e = 0.2D$	$a_p = 1.0D$ $a_e = 0.2D$	
	Finishing	$a_p = 0.6D$ $a_e = 0.04D$	$a_p = 0.8D$ $a_e = 0.05D$	
Note		Recommend air blow.		Recommend water soluble or oil coolant.

 a_p : Axial Depth (mm) a_e : Radial Depth (mm)

D : Outside Diameter (mm)

UDC
SeriesCBN
Series

Square

Long Neck
Square

Radius

Long Neck
RadiusTaper Neck
RadiusBall / Long
Shank BallLong Neck
BallTaper Neck
Ball

Taper

Spiral
V Cutter

Drill

EURO Series

Technical Data



Size $\phi 4 \sim \phi 10$

CPRS30N



Material Applications (☆ Highly Recommended ● Recommended ○ Suggested)

Work Material															
Carbon Steels S45C S55C	Alloy Steels SK / SCM SUS	Prehardened Steels NAK HPM	Hardened Steels			Cast Iron	Aluminum Alloys	Graphite	Copper	Plastics	Glass Filled Plastics	Titanium Alloys	Heat Resistant Alloys	Cemented Carbide	Hard Brittle (Non-Metallic) Materials
			~55HRC	~60HRC	~70HRC										
							●		○	●					

Features

Non coated Long Neck Radius for Aluminum Alloys and Plastics.
Designed for finishing applications.

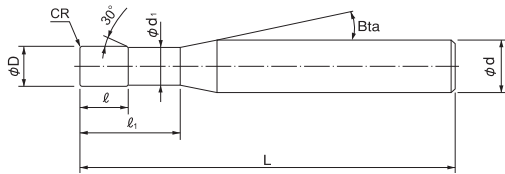

The shank taper angle shown is not an exact value and to avoid contact with the work piece, we recommend the user controls the precise value of this angle. Shank taper angle should not make contact with the work piece.

Total 7 models

Unit (mm)

Model Number	Outside Diameter ϕD	Corner Radius CR	Effective Length ℓ_1	Length of Cut ℓ	Neck Diameter ϕd_1	Shank Taper Angle Bta	Overall Length L	Shank Diameter ϕd	Price ¥
CPRS30N 2040-030-10	4	R0.3	10	5	3.63	16°	50	6	8,800
CPRS30N 2060-025-20	6	R0.25	20	8	5.43	—	60	6	14,000
CPRS30N 2060-050-20		R0.5	20				60	6	14,000
CPRS30N 2080-030-30	8	R0.3	30	10	7.82	—	80	8	16,200
CPRS30N 2080-060-30		R0.6	30				80	8	16,200
CPRS30N 2100-030-36	10	R0.3	36	12	9.82	—	80	10	21,000
CPRS30N 2100-080-36		R0.8	36				80	10	21,000

- UDC Series
- CBN Series
- Square
- Long Neck Square
- Radius
- Long Neck Radius
- Taper Neck Radius
- Ball / Long Shank Ball
- Long Neck Ball
- Taper Neck Ball
- Taper
- Spiral V Cutter
- Drill
- EURO Series
- Technical Data

Milling Conditions for CPRS30N (2 Flutes)

WORK MATERIAL		PLASTICS			ALUMINUM ALLOYS		
Model Number	Outside Diameter (mm)	Spindle Speed (min ⁻¹)	Feed Rate (Slotting) (mm/min)	Feed Rate (Side milling) (mm/min)	Spindle Speed (min ⁻¹)	Feed Rate (Slotting) (mm/min)	Feed Rate (Side milling) (mm/min)
2040	4	12,000	600	900	12,000	615	920
2060	6	8,000	400	600	8,000	690	1,040
2080	8	6,000	300	450	6,000	735	1,100
2100	10	4,800	240	360	4,800	825	1,240

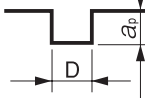
Slotting Milling Amount (mm)			
	Roughing	$a_p = 0.5D$	$D \leq 2 \quad a_p = 0.2D$ $D \geq 3 \quad a_p = 0.5D$
	Finishing	$a_p = 0.03D$	$a_p = 0.05D$
Side Milling Milling Amount (mm)	Roughing	$a_p = 1.0D$ $a_e = 0.2D$	$a_p = 1.0D$ $a_e = 0.2D$
	Finishing	$a_p = 0.6D$ $a_e = 0.04D$	$a_p = 0.8D$ $a_e = 0.05D$
Note		Recommend air blow.	Recommend water soluble or oil coolant.

 a_p : Axial Depth (mm) a_e : Radial Depth (mm)

D : Outside Diameter (mm)

UDC
SeriesCBN
Series

Square

Long Neck
Square

Radius

Long Neck
RadiusTaper Neck
Radius

Ball

Ball / Long
Shank BallLong Neck
BallTaper Neck
Ball

Taper

Taper

Spiral
V Cutter

Drill

EURO Series

Technical Data

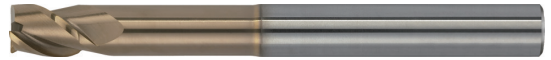

Size $\phi 2 \sim \phi 12$

CRS40HSP



Material Applications (☆ Highly Recommended ○ Recommended ○ Suggested)

Work Material															
Carbon Steels S45C S55C	Alloy Steels SK / SCM SUS	Prehardened Steels NAK HPM	Hardened Steels			Cast Iron	Aluminum Alloys	Graphite	Copper	Plastics	Glass Filled Plastics	Titanium Alloys	Heat Resistant Alloys	Cemented Carbide	Hard Brittle (Non-Metallic) Materials
			~55HRC	~60HRC	~70HRC										
○	○	○	○	○		○				○					

Features

Highly Efficient Long Neck Radius with short flute length.

Helix angle 40°.

Broad application range from SUS up to Hardened Steels (60HRC).

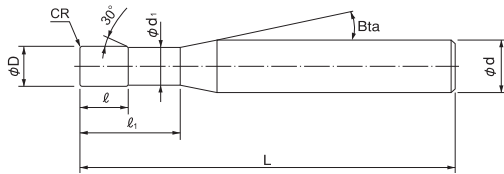

The shank taper angle shown is not an exact value and to avoid contact with the work piece, we recommend the user controls the precise value of this angle. Shank taper angle should not make contact with the work piece.

Total 25 models

Unit (mm)

Model Number	Outside Diameter ϕD	Corner Radius CR	Effective Length l_1	Length of Cut l	Neck Diameter ϕd_1	Shank Taper Angle Bta	Overall Length L	Shank Diameter ϕd	Price ¥		
CRS40HSP 3020-020-06	2	RO.2	6	3	1.93	16°	38	3	11,500		
CRS40HSP 3020-020-10			10				60		12,000		
CRS40HSP 3025-020-06	2.5	RO.2	6	4	2.43	16°	38	3	11,500		
CRS40HSP 3030-010-07	3	RO.1	7	4	2.84	—	38	3	11,500		
CRS40HSP 3030-020-07		RO.2	14				60		3	12,000	
CRS40HSP 3030-020-14											
CRS40HSP 3035-020-09	3.5	RO.2	9	5	3.24	16°	50	6	12,800		
CRS40HSP 3040-020-09	4	RO.2	9	5	3.74	16°	50	6	12,800		
CRS40HSP 3040-020-18			18				65		6	13,200	
CRS40HSP 3040-030-09			RO.3				9		50	6	12,800
CRS40HSP 3040-050-09			RO.5						50	6	12,800
CRS40HSP 3050-020-11			11				50		6	13,200	
CRS40HSP 3050-020-22	22	65	6	13,800							
CRS40HSP 3060-020-14	6	RO.2	14	7	5.64	—	60	6	14,600		
CRS40HSP 3060-030-14			RO.3				26		60	6	14,600
CRS40HSP 3060-030-26									80	6	15,200
CRS40HSP 3060-050-14			RO.5				14		60	6	14,600

Unit (mm)

Model Number	Outside Diameter ϕD	Corner Radius CR	Effective Length ℓ_1	Length of Cut ℓ	Neck Diameter ϕd_1	Shank Taper Angle Bta	Overall Length L	Shank Diameter ϕd	Price ¥
CRS40HSP 3080-020-18	8	RO.2	18	9	7.82	—	60	8	18,400
CRS40HSP 3080-050-18		RO.5					60	8	18,400
CRS40HSP 3080-050-36			36				90	8	19,200
CRS40HSP 3100-020-25	10	RO.2	25	12	9.82	—	70	10	24,000
CRS40HSP 3100-050-25		RO.5					70	10	24,000
CRS40HSP 3100-050-45			45				100	10	26,000
CRS40HSP 3120-050-30	12	RO.5	30	15	11.82	—	75	12	30,400
CRS40HSP 3120-050-54			54				120	12	32,000

Milling Conditions for CRS40HSP (3 Flutes)

WORK MATERIAL		CARBON STEELS / CAST IRON			PREHARDENED STEELS (30~48 HRC)			ALLOY STEELS		
Model Number	Outside Diameter (mm)	Spindle Speed (min ⁻¹)	Feed Rate (Slotting) (mm/min)	Feed Rate (Side milling) (mm/min)	Spindle Speed (min ⁻¹)	Feed Rate (Slotting) (mm/min)	Feed Rate (Side milling) (mm/min)	Spindle Speed (min ⁻¹)	Feed Rate (Slotting) (mm/min)	Feed Rate (Side milling) (mm/min)
3020	2	22,000	610	810	14,500	380	500	12,000	310	410
3025	2.5	19,000	640	860	12,100	410	550	10,100	340	460
3030	3	17,000	680	900	10,500	440	590	8,800	380	500
3035	3.5	15,500	980	1,300	9,600	610	810	8,000	490	650
3040	4	14,500	1,220	1,620	8,800	750	990	7,500	610	810
3050	5	12,000	1,290	1,710	7,200	780	1,040	6,000	650	860
3060	6	10,500	1,420	1,890	6,500	810	1,080	5,500	710	950
3080	8	8,000	1,520	2,030	4,800	810	1,080	4,000	750	990
3100	10	6,500	1,320	1,760	3,800	650	860	3,200	650	860
3120	12	5,500	1,120	1,490	3,200	540	720	2,500	510	680

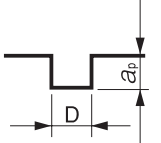
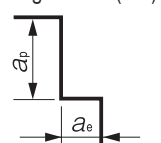
Slotting Milling Amount (mm) 	Roughing	$a_p = 0.095D$	$a_p = 0.045D$	$a_p = 0.04D$
	Finishing	$a_p = 0.03D$	$a_p = 0.02D$	$a_p = 0.01D$
Side Milling Milling Amount (mm) 	Roughing	$a_p = 1.0D$ $a_e = 0.045D$	$a_p = 0.8D$ $a_e = 0.035D$	$a_p = 0.8D$ $a_e = 0.02D$
	Finishing	$a_p = 0.85D$ $a_e = 0.03D$	$a_p = 0.65D$ $a_e = 0.02D$	$a_p = 0.55D$ $a_e = 0.01D$
Note		Recommend air blow.	Recommend air blow.	Recommend air blow.

 a_p : Axial Depth (mm) a_e : Radial Depth (mm)

D : Outside Diameter (mm)

3 Flutes

UDC Series

CBN Series

Square

Square

Radius

Radius

Radius

Ball / Long Shank Ball

Ball

Ball

Taper

Spiral V Cutter

Drill

EURO Series

Technical Data

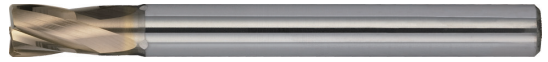

Size $\phi 2 \sim \phi 12$

CRS20HSP



Material Applications (☆ Highly Recommended ○ Recommended ○ Suggested)

Work Material															
Carbon Steels S45C S55C	Alloy Steels SK / SCM SUS	Prehardened Steels NAK HPM	Hardened Steels			Cast Iron	Aluminum Alloys	Graphite	Copper	Plastics	Glass Filled Plastics	Titanium Alloys	Heat Resistant Alloys	Cemented Carbide	Hard Brittle (Non-Metallic) Materials
			~55HRC	~60HRC	~70HRC										
○		○	◎	◎		◎									

Features

4 flute Long Neck Radius with high rigidity for hard materials.
Helix angle 20°.

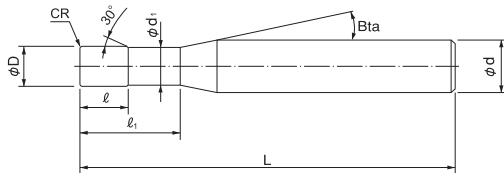

The shank taper angle shown is not an exact value and to avoid contact with the work piece, we recommend the user controls the precise value of this angle. Shank taper angle should not make contact with the work piece.

Total 9 models

Unit (mm)

Model Number	Outside Diameter ϕD	Corner Radius CR	Effective Length ℓ_1	Length of Cut ℓ	Neck Diameter ϕd_1	Shank Taper Angle Bta	Overall Length L	Shank Diameter ϕd	Price ¥
CRS20HSP 4020-020-05	2	R0.2	5	2.5	1.93	16°	50	6	8,700
CRS20HSP 4025-025-06	2.5	R0.25	6	3	2.43	16°	50	6	9,500
CRS20HSP 4030-030-07	3	R0.3	7	4	2.84	16°	50	6	7,800
CRS20HSP 4040-040-09	4	R0.4	9	5	3.74	16°	50	6	11,600
CRS20HSP 4050-050-12	5	R0.5	12	6	4.64	16°	50	6	16,800
CRS20HSP 4060-060-14	6	R0.6	14	7	5.64	—	55	6	16,800
CRS20HSP 4080-080-18	8	R0.8	18	10	7.82	—	60	8	18,400
CRS20HSP 4100-100-25	10	R1	25	12	9.82	—	70	10	24,000
CRS20HSP 4120-120-30	12	R1.2	30	15	11.82	—	75	12	29,000

Milling Conditions for CRS20HSP (4 Flutes)

WORK MATERIAL		CARBON STEELS / CAST IRON			PREHARDENED STEELS (30~48 HRC)			HARDENED STEELS (48~56 HRC)			HARDENED STEELS (56~60 HRC)		
Model Number	Outside Diameter (mm)	Spindle Speed (min ⁻¹)	Feed Rate (Slotting) (mm/min)	Feed Rate (Side milling) (mm/min)	Spindle Speed (min ⁻¹)	Feed Rate (Slotting) (mm/min)	Feed Rate (Side milling) (mm/min)	Spindle Speed (min ⁻¹)	Feed Rate (Slotting) (mm/min)	Feed Rate (Side milling) (mm/min)	Spindle Speed (min ⁻¹)	Feed Rate (Slotting) (mm/min)	Feed Rate (Side milling) (mm/min)
4020-020-05	2	22,000	810	1,080	14,400	510	680	9,600	210	280	4,800	90	120
4025-025-06	2.5	19,000	860	1,140	12,100	550	730	7,700	250	340	4,100	130	180
4030-030-07	3	17,000	900	1,200	10,600	600	800	6,400	255	340	3,600	105	140
4040-040-09	4	14,400	1,620	2,160	8,800	990	1,320	5,400	330	440	2,800	145	195
4050-050-12	5	12,000	1,710	2,280	7,200	1,050	1,400	4,400	360	480	2,400	140	190
4060-060-14	6	10,600	1,890	2,520	6,400	1,080	1,440	4,000	450	600	2,000	135	185
4080-080-18	8	8,000	2,040	2,720	4,800	1,080	1,440	3,200	540	720	1,600	130	175
4100-100-25	10	6,400	1,770	2,360	3,800	870	1,160	2,600	450	600	1,300	120	165
4120-120-30	12	5,400	1,500	2,000	3,200	720	960	2,200	420	560	1,060	105	140

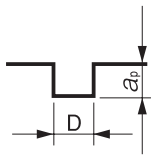
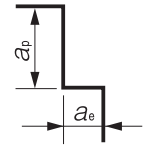
Slotting Milling Amount (mm) 	Roughing	$a_p = 0.095D$	$a_p = 0.045D$	$a_p = 0.045D$	$a_p = 0.025D$
	Finishing	$a_p = 0.03D$	$a_p = 0.02D$	$a_p = 0.02D$	$a_p = 0.01D$
Side Milling Milling Amount (mm) 	Roughing	$a_p = 1.0D$ $a_e = 0.045D$	$a_p = 0.8D$ $a_e = 0.035D$	$a_p = 0.8D$ $a_e = 0.032D$	$a_p = 0.75D$ $a_e = 0.025D$
	Finishing	$a_p = 0.85D$ $a_e = 0.035D$	$a_p = 0.65D$ $a_e = 0.02D$	$a_p = 0.65D$ $a_e = 0.02D$	$a_p = 0.45D$ $a_e = 0.01D$
Note		Recommend air blow.	Recommend air blow.	Recommend air blow.	Recommend air blow.

a_p : Axial Depth (mm)

a_e : Radial Depth (mm)

D : Outside Diameter (mm)

4 Flutes

UDC Series

CBN Series

Square

Long Neck Square

Radius

Long Neck Radius

Taper Neck Radius

Ball / Long Shank Ball

Long Neck Ball

Taper Neck Ball

Taper

Spiral V Cutter

Drill

EURO Series

Technical Data

OPTECH-MES/MES-D50



Non-contact dynamic run out measurement of the tool with Micro Eyes !

Features

- Diameter & Run-out detection improves the milling quality and stability.**
 Allowing the process to operate at the optimum condition by controlling the Machine spindle & tool setting.
- Prevents problems with tool life by detecting the tool tip.**
 Detects tool damage & wear on micro tools.
- Price cut from the conventional product.**
 Priced below the current OPTECH-Me/EDR-D20 measuring device.

Measuring example

■ End mill Measuring Accuracy (Diameter)

Spindle speed (min ⁻¹)	End mill size (mm)					
	φ0.2	φ0.5	φ0.9	φ2.0	φ2.5	φ3.0
0	-1	0	0	1	1	0
30,000	-1	0	-1	0	-1	-1
60,000	-1	-1	-2	-	-	-
120,000	-1	-	-	-	-	-

Unit (μm)

■ Tool tip detection repeatability

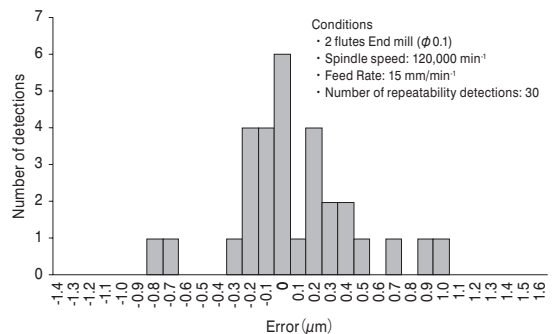

UDC Series

CBN Series

Square
Long Neck Square

Radius

Radius
Long Neck Radius
Taper Neck Radius

Ball / Long Shank Ball

Ball
Long Neck Ball
Taper Neck Ball

Taper

Spiral V Cutter

Drill

EURO Series

Technical Data

Dimensions Plan (mm)

OPTECH-MES(sensor)

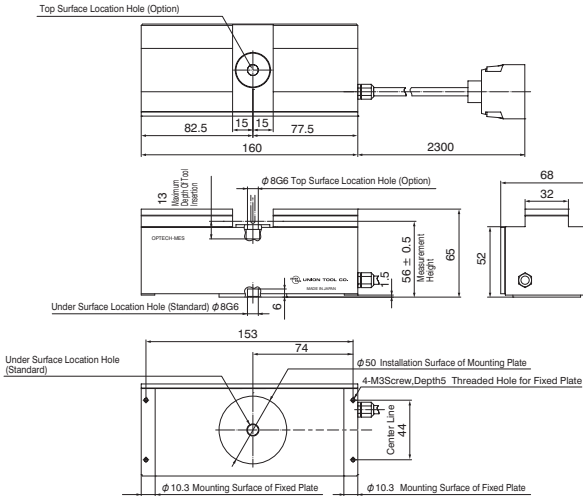

MES-D50(display)

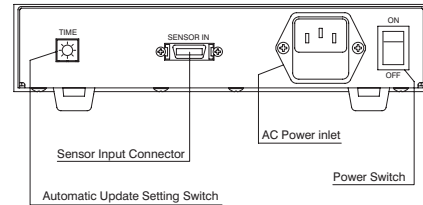
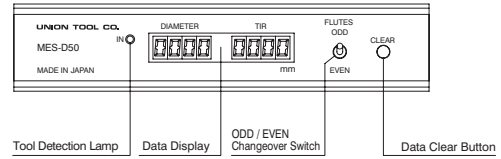

Optech Series OPTECH-MES/MES-D50

Items	Specification	
Measuring Items	<ul style="list-style-type: none"> Tool Diameter, Dynamic run-out (Even number of flutes) Diameter including dynamic run-out (Odd number of flutes) Spindle run-out by pin gauge Tool Tip Detection 	
Measuring Range	φ0.05 ~ φ3.0 (mm)	
Range of Runout Measurement	0 ~ 0.099 (mm)	
Resolution	1 (μm)	
Measuring Accuracy ^{※1}	Diameter	2 (μm) (φ0.05 ~ φ1.5 (mm)) 4 (μm) (φ1.5 ~ φ3.0 (mm))
	Run-out	within 2 (μm)
	Tool Tip Detection ^{※2} (Repeatability)	3 (μm) (Diameter below φ0.2 (mm), Square End mills, Radius End mills) 2 (μm) (Diameter below φ3.0 (mm), Ball End mills, Drills)
Measuring Spindle Rotation	<ul style="list-style-type: none"> within 120,000 (min⁻¹) (φ0.05 ~ φ0.1 (mm) or below) within 60,000 (min⁻¹) (φ0.1 ~ φ1.0 (mm) or below) within 30,000 (min⁻¹) (φ1.0 ~ φ3.0 (mm) or below) 	
Tool Tip Measurement Position ^{※3}	56 mm ± 0.5 mm from bottom surface of the detector	
Measuring Point Range	within ± 0.02 (mm) ^{※4}	
Dimensions/Mass	<ul style="list-style-type: none"> Sensor : W160 × D68 × H65 (mm) 0.7 (kg) Display : W200 × D200 × H42 (mm) 1.6 (kg) 	
Display	<ul style="list-style-type: none"> Diameter, Run-out display (Diameter, TIR), 4 digits each Tool tip detection indicator (IN) Lamp ON 	
Functions	<ul style="list-style-type: none"> Odd/even cutters switch (ODD/EVEN) Data refresh interval (TIME) No/Yes: Approximately 0.5s, 1.0s, 1.5s, 2.0s Clear (CLR) 	
Power Source	AC100 ~ 240 (V) 50/60 Hz	
Cable Length	2.3 (m)	
Price	¥440,000	

※1 Quantization errors are not included.

※2 Lamp lights when the tool is detected. Check the scale on milling machine for the actual value.

※3 Absolute position is different on individual tool. Adjust/Assemble the position within 56 ± 0.5mm.

※4 Set the tool position within ± 0.02 mm (XY direction) from the center of gauge hole.

UDC Series

CBN Series

Square

Long Neck Square

Radius

Long Neck Radius

Taper Neck Radius

Ball / Long Shank Ball

Long Neck Ball

Taper Neck Ball

Taper

Spiral V Cutter

Drill

EURO Series

Technical Data



Calculation of Milling Conditions

Proper tool selection, machine condition, feed and speeds are essential for successful milling. The optimum machining conditions are calculated using the formulas below.

Formulas for calculation of end milling conditions

1. Velocity : V_c (m/min)

$$V_c = \frac{\pi \times D \times n}{1000}$$

$\pi = 3.14$ (Circular Constant)
 $D =$ Outside Diameter (mm)
 $n =$ Spindle Speed (min^{-1})

2. Spindle Speed : n (min^{-1})

$$n = \frac{1000 \times V_c}{\pi \times D}$$

$V_c =$ Velocity (m/min)
 $\pi = 3.14$ (Circular Constant)
 $D =$ Outside Diameter (mm)

3. Feed Rate : V_f (mm/min)

$$V_f = n \times z \times f_z$$

$n =$ Spindle Speed (min^{-1})
 $z =$ Number of flutes
 $f_z =$ Feed per tooth (mm/t)

4. Feed per tooth : f_z (mm/t)

$$f_z = \frac{V_f}{n \times z}$$

$V_f =$ Feed Rate (mm/min)
 $n =$ Spindle Speed (min^{-1})
 $z =$ Number of flutes

Explanation of terms used in parameters

1. Velocity V_c [Unit: m/min] :

The milling distance of an optional point on the circumference per unit (1 minute)

Related Value — Diameter ϕD [mm] : Twice the distance from the center of a circle (radius)
 π : Circular constant = 3.14 (Unit : Nil)
 Spindle Speed n [min^{-1}] : Revolutions per minute
 $[\text{min}^{-1}] = [\text{rpm} ; \text{revolutions per minute}]$

UDC Series

CBN Series

Square

Long Neck Square

Radius

Long Neck Radius

Taper Neck Radius

Ball / Long Shank Ball

Long Neck Ball

Taper Neck Ball

Taper

Spiral V Cutter

Drill

EURO Series

Technical Data

- Length of Circumference = Diameter \times pi : πD [mm]
- Velocity V_c : Milling length per minute = Length of circumference \times Spindle rotation speed

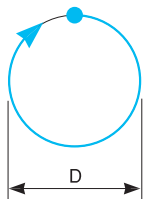

$$V_c = \pi \times D \text{ [mm]} \times n \text{ [min}^{-1}\text{]}$$



$$V_c = \frac{\pi \times D \text{ [mm]} \times n \text{ [min}^{-1}\text{]}}{1000} \text{ [m/min]}$$

Unit Conversion : 1 mm = 1/1000 m therefore...
 $D \text{ [mm]} = D/1000 \text{ [m]}$

2. Feed per tooth f_z [Unit:mm/t]

Related Value	—	Feed Rate V_f [mm/min]	: Amount of feed per minute
		Spindle Speed n [min ⁻¹]	: Revolutions per minute [min ⁻¹] = [rpm ; revolutions per minute]
		Number of Flutes z	: Number of flutes

- The amount of feed per rotation is described below. (rev = revolution)

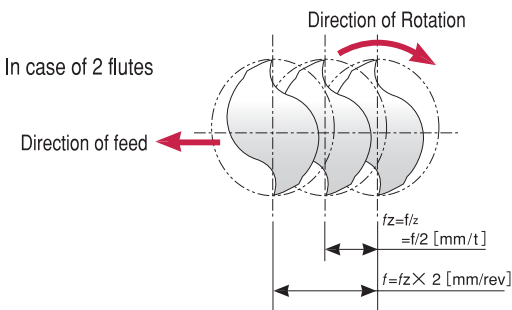

$$f = \frac{V_f \text{ [mm/min]}}{n \text{ [rev/min]}} = \frac{V_f}{n} \left[\frac{\text{mm}}{\text{min}} \right] \times \left[\frac{\text{min}}{\text{rev}} \right]$$

$$= \frac{V_f}{n} \text{ [mm/rev]}$$

※ [min⁻¹] = [rev/min]

- The amount of feed per flute is calculated using the feed rate divided by the number of flutes.

$$f_z = \frac{f \text{ [mm/rev]}}{z} = \frac{V_f}{n \times z} \text{ [mm/t]}$$

UDC Series

CBN Series

Square

Long Neck Square

Radius

Long Neck Radius

Taper Neck Radius

Ball / Long Shank Ball

Long Neck Ball

Taper Neck Ball

Taper

Spiral V Cutter

Drill

EURO Series

Technical Data



Using the Parameter Chart

example 1

<How to calculate spindle speed and feed rate >

For example: C-CES2080 NAK55 (39HRC) high speed milling

- (1) Determine the velocity V_c based on the type of work material or its hardness.
Parameter chart on page 165 shows $V_c=200$ m/min.
- (2) We know the Outside diameter, we can set spindle speed (n) and feed rate (V_f).
NAK55 is in the Prehardened Steel column. Velocity V_c is 200 m/min.
From the table, the Outside diameter (D) is 8.0 mm, then
 $n = 7900 \text{ min}^{-1}$ and $V_f = 405 \text{ mm/min}$.
- (3) Set the Z-axis cutting depth to approximately half of the outside diameter.

example 2

<How to calculate feed rate >

- Case 1. You want to work on S50C with a C-CES2030 End Mill, but the milling machine has $3,500 \text{ min}^{-1}$ maximum Spindle capability only. What is the feed rate with the conditions given?

Based on a feed per tooth 0.0135 mm/t

$$V_f := (n \times z \times f_z) = (3,500 \times 2 \times 0.0135) = 94.5$$

n : Spindle speed

z : Number of flutes

f_z : Feed per tooth

$$n = 3,500 \text{ min}^{-1}, V_f := 94.5 \text{ mm/min}$$

<How to calculate the spindle speed>

- Case 2. You want to work on NAK80 with a C-CES2100 End Mill at velocity 22 m/min . What is the spindle speed for this application?

$$n = \frac{1000 V_c}{\pi D} = \frac{1000 \times 22}{3.14 \times 10} = 700 \text{ min}^{-1}$$

- Case 3. Calculating the spindle speed when side milling using C-CTE 4100-3

Work material: Carbon Steel

Velocity : 40 m/min .

Outside Diameter D is calculated about 1/3 to 1/2 of cutting depth from bottom.

For example: If the blade length is 35 mm, cutting depth is 18 mm.

Outside Diameter $D1 = (1/3 \times \text{Axial Depth } a_p \times \tan(\text{half included angle})) \times 2 + \text{tip diameter}$

$$= (1/3 \times 18 \times \tan 1.5^\circ) \times 2 + \phi 10 \doteq 10.3$$

$$\text{Spindle speed } n = \frac{1000 V_c}{\pi D} = \frac{1000 \times 40}{3.14 \times 10.3} = 1,237 \text{ min}^{-1}$$

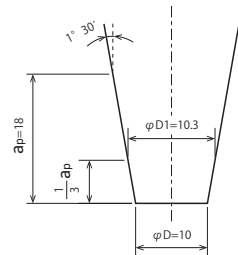

UDC Series

CBN Series

Square

Long Neck Square

Radius

Long Neck Radius

Taper Neck Radius

Ball / Long Shark Ball

Long Neck Ball

Taper Neck Ball

Taper

Spiral V Cutter

Drill

EURO Series

Technical Data

Diagram of End Mill Virtual Diameter

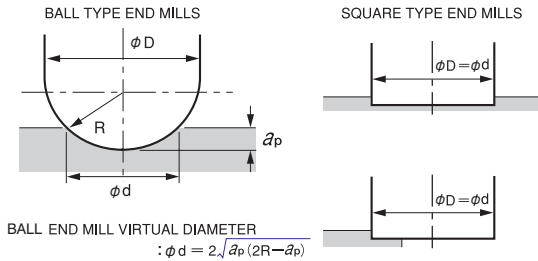

Square type diameter equals to the virtual diameter.
Ball type virtual diameter will vary depending on the contact point with work material and milling depth.
The velocity of Ball End Mill can be calculated by using the virtual diameter.

Velocity of virtual diameter (V) can be calculated by the following formula.

$$V_C(\text{m/min}) = \pi \times \phi d (\text{mm}) \times n (\text{min}^{-1}) / 1000$$

Ex.) With virtual diameter $\phi 1$ mm and spindle speed 30,000 (min^{-1}),

$$V_C(\text{m/min}) \text{ is } : V_C(\text{m/min}) = 3.14 \times \phi 1 (\text{mm}) \times 30,000 (\text{min}^{-1}) / 1000 \\ = 94.2 \text{ m/min}$$

Virtual Diameter of Ball End Mill (mm)

a_p : Axial Depth (mm)

(Unit : mm)

R	a_p	0.01	0.02	0.03	0.04	0.05	0.1	0.15	0.2	0.25	0.3	0.4
R0.1		0.087	0.120	0.143	0.160	0.173	0.200	—	—	—	—	—
R0.15		0.108	0.150	0.180	0.204	0.224	0.283	0.300	—	—	—	—
R0.2		0.125	0.174	0.211	0.240	0.265	0.346	0.387	0.400	—	—	—
R0.25		0.140	0.196	0.237	0.271	0.300	0.400	0.458	0.490	0.500	—	—
R0.3		0.154	0.215	0.262	0.299	0.332	0.447	0.520	0.566	0.592	0.600	—
R0.4		0.178	0.250	0.304	0.349	0.387	0.529	0.624	0.693	0.742	0.775	0.800
R0.5		0.199	0.280	0.341	0.392	0.436	0.600	0.714	0.800	0.866	0.917	0.980
R0.6		0.218	0.307	0.375	0.431	0.480	0.663	0.794	0.894	0.975	1.039	1.131
R0.7		0.236	0.332	0.405	0.466	0.520	0.721	0.866	0.980	1.072	1.149	1.265
R0.8		0.252	0.356	0.434	0.500	0.557	0.775	0.933	1.058	1.162	1.249	1.386
R0.9		0.268	0.377	0.461	0.531	0.592	0.825	0.995	1.131	1.245	1.342	1.497
R1		0.282	0.398	0.486	0.560	0.624	0.872	1.054	1.200	1.323	1.428	1.600
R1.5		0.346	0.488	0.597	0.688	0.768	1.077	1.308	1.497	1.658	1.800	2.040
R2		0.399	0.564	0.690	0.796	0.889	1.249	1.520	1.744	1.936	2.107	2.400
R2.5		0.447	0.631	0.772	0.891	0.995	1.400	1.706	1.960	2.179	2.375	2.713
R3		0.489	0.692	0.846	0.977	1.091	1.536	1.873	2.154	2.398	2.615	2.993
R4		0.565	0.799	0.978	1.129	1.261	1.778	2.170	2.498	2.784	3.040	3.487
R5		0.632	0.894	1.094	1.262	1.411	1.990	2.431	2.800	3.122	3.412	3.919
R6		0.693	0.979	1.198	1.383	1.546	2.182	2.666	3.072	3.428	3.747	4.308

R	a_p	0.5	0.6	0.7	0.8	0.9	1	1.5	2	2.5	3
R0.5		1.000	—	—	—	—	—	—	—	—	—
R0.6		1.183	1.200	—	—	—	—	—	—	—	—
R0.7		1.342	1.386	1.400	—	—	—	—	—	—	—
R0.8		1.483	1.549	1.587	1.600	—	—	—	—	—	—
R0.9		1.612	1.697	1.755	1.789	1.800	—	—	—	—	—
R1		1.732	1.833	1.908	1.960	1.990	2.000	—	—	—	—
R1.5		2.236	2.400	2.538	2.653	2.750	2.828	3.000	—	—	—
R2		2.646	2.857	3.040	3.200	3.341	3.464	3.873	4.000	—	—
R2.5		3.000	3.250	3.470	3.666	3.842	4.000	4.583	4.899	5.000	—
R3		3.317	3.600	3.852	4.079	4.285	4.472	5.196	5.657	5.916	6.000
R4		3.873	4.214	4.521	4.800	5.056	5.292	6.245	6.928	7.416	7.746
R5		4.359	4.750	5.103	5.426	5.724	6.000	7.141	8.000	8.660	9.165
R6		4.796	5.231	5.625	5.987	6.321	6.633	7.937	8.944	9.747	10.392

UDC Series

CBN Series

Square

Long Neck Square

Radius

Long Neck Radius

Taper Neck Radius

Ball / Long Shank Ball

Long Neck Ball

Taper Neck Ball

Taper

Spiral V Cutter

Drill

EURO Series

Technical Data

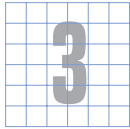

Features of UNIMAX End Mill

Owing to the in-house specialized fluting machine and improved grinding wheel, UNIMAX End Mill has realized continuous sharp cutting edge.

This feature enables to get the fine surface roughness and the microscopic finishing.

Ball End Mills have a high precision finish with minimized error of radius accuracy.

UNIMAX SHARP CUTTING EDGE

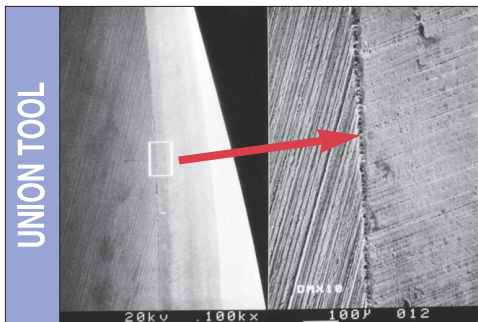

COMPETITOR'S CUTTING EDGE

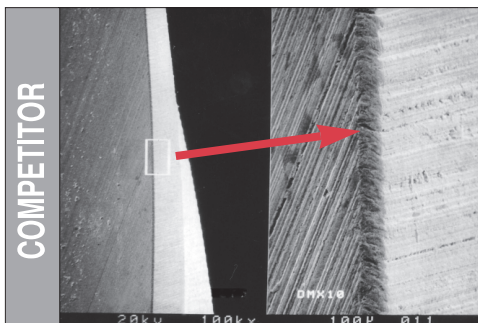

● COMPETITOR'S CUTTING EDGE

The cutting edge have been honing to prevent chipping.

This makes microscopic milling in the final finishing difficult and causes the cutting edge to diverge from the targeted work finishing surface.

UDC Series

CBN Series

Square
Long Neck Square

Radius

Long Neck Radius
Taper Neck Radius

Ball / Long Shark Ball

Long Neck Ball
Taper Neck Ball

Taper

Spiral V Cutter

Drill

EURO Series

Technical Data

CSEB / CSELB

Features of CSEB / CSELB Series for Broad Applications from Copper / Raw Materials to 55HRC

- ◆ **Optimized Cutting Edge Geometry**
Offering durability when roughing, and excellent surface quality for finishing.
- ◆ **UTCOAT**
Better wear resistance with improved hardness, durability, lubricity and coating adhesion.
- ◆ **Broad Application Range**
From Copper/Raw Materials up to 55HRC.

Tool Shape

① Helical Ball Shape

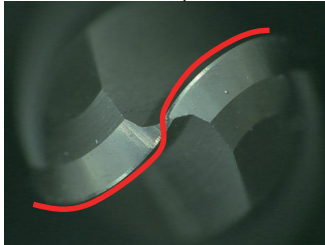

Reduce cutting resistance & tool damage!

② Minute Relief Face



Minimal chipping & wearing!

③ Optimized Ball Tip Geometry

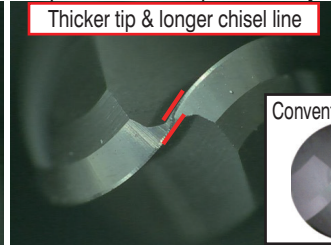

Ball tip improves finishing performance!

Conventional C-CEB

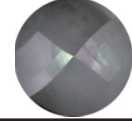

UTCOAT

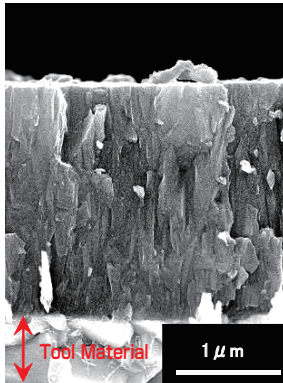

◆ UTCOAT Cross Section

Very Hard Coating with Low Friction Properties
Ultra hard coating >>> Outstanding wear resistance!

High Durability and Adhesion
Fibrous look (high durable) layer offers dramatic performance in resisting chipping during the roughing process. Strong adhesion properties ensure the coating adheres to the carbide.

◆ Coating Friction Coefficient Comparison

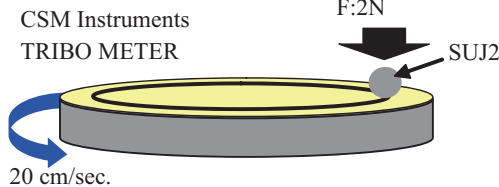

UTCOAT has smooth surface!
Ideal for sticky materials!

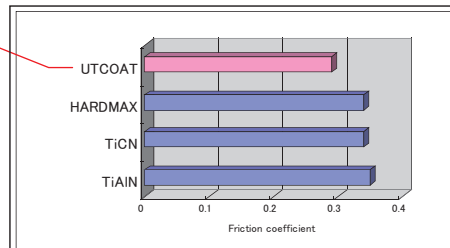

UDC Series

CBN Series

Square
Long Neck Square

Radius
Long Neck Radius

Taper Neck Radius

Ball / Long Shank Ball

Ball
Long Neck Ball
Taper Neck Ball

Taper
Taper

Spiral V Cutter

Drill

EURO Series

Technical Data

HSB / HSLB

Features of HSB / HSLB Series for Hard Materials over 40HRC

- ◆ **Variable Rake Angle Design**
Rake angle transition from ball tip to peripheral cutting edge.
- ◆ **HARDMAX Coating**
HARDMAX coat offers heat resistance, durability and lubricity at a high level.
- ◆ **Recommended for Hard Materials**
Amazing efficiency with long life and excellent surface finishing on hard materials over 40HRC.
- ◆ **Suitable for Various Coolant**
Every coolant offers stable milling.

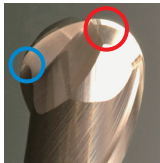

Variable Rake Angle

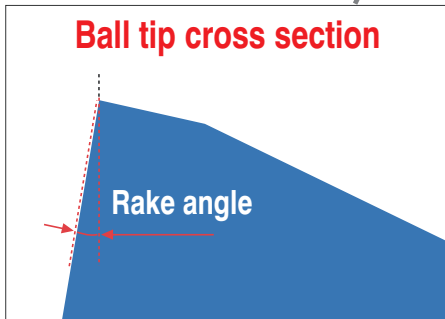
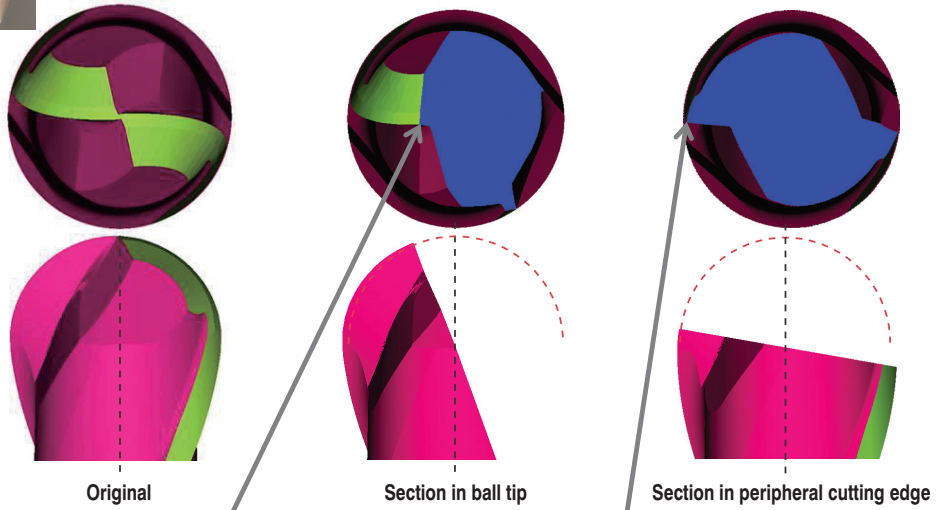

Ball tip point: **Super negative**
Thicker cutting edge improves chipping resistance!

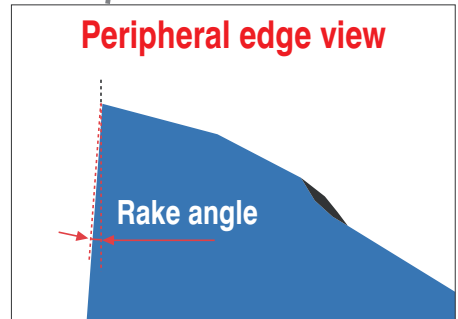
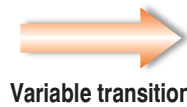

Peripheral cutting edge: **Slightly negative**
Small cutting resistance
>> Great surface finish!

UDC Series

CBN Series

Square
Long Neck Square

Radius

Radius
Long Neck Radius
Taper Neck Radius

Ball / Long Shank Ball

Ball
Long Neck Ball
Taper Neck Ball

Taper

Spiral V Cutter

Drill

EURO Series

Technical Data

HGB / HGLB

Features of HGB / HGLB for Hardened Steels

- ◆ Adopted new coating "HMGCOAT"
 - Newly developed "HMGCOAT" (HARDMAX GREAT COAT)
 - High hardness coating offers higher wear resistance compared to HARDMAX.
- ◆ New Carbide Materials with excellent wear resistance
- ◆ New design with improved breakage resistance
 - The rake and relief angles optimized for milling hard materials improve breakage resistance.
- ◆ High Precision Diameter Tolerance / Radius Accuracy / Shank Diameter Tolerance

Newly developed HMGCOAT

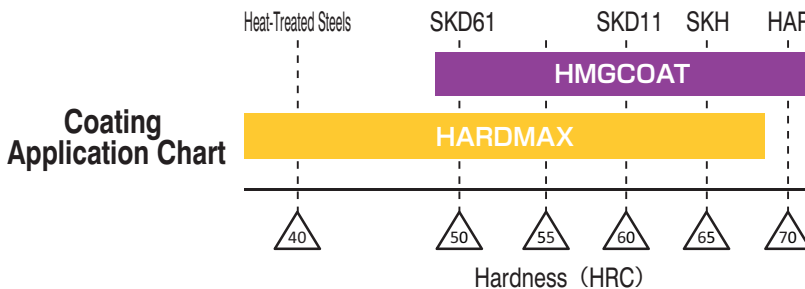

New Design for Hard Materials

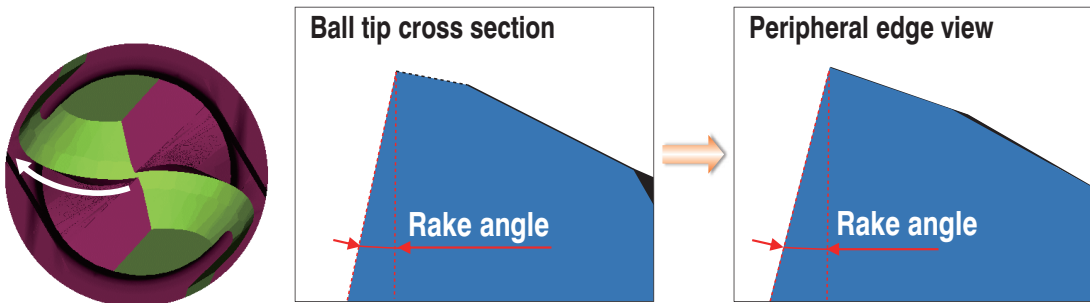

The negative rake angle of the ball gives a gradual angle variation towards the peripheral side. This improves the strength of the entire cutting edge, and tightens the twist of the ball.

UDC Series

CBN Series

Square
Long Neck Square

Radius

Long Neck Radius

Taper Neck Radius

Ball / Long Shank Ball

Long Neck Ball

Taper Neck Ball

Taper

Spiral V Cutter

Drill

EURO Series

Technical Data

HGB / HGLB Milling Example

Spur Gear
HGB / HGLB R0.5 · R1 · R1.5

HAP72 (68HRC)

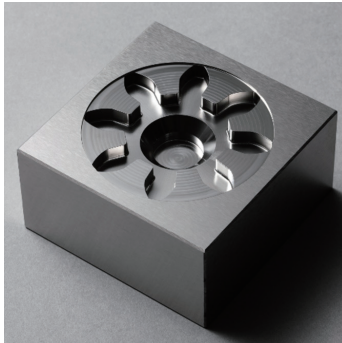

Work Size : 60 x 60 x 30 mm
Milled Size : ϕ 50.4 x Depth 11 mm
Coolant : Air Blow (Through Spindle)



HGB / HGLB
Spur Gear
Milling Video

No.	Milling Process	Tool	Spindle Speed (min ⁻¹)	Feed Rate (mm/min)	a_p Axial Depth (mm)	a_e Radial Depth (mm)	Allowance (mm)	Cycle Time (h:m)
1	Roughing	HGB 2030-0450 (R1.5 x Length of Cut 4.5)	8,280	1,140	0.12	0.55	0.02	1:41
2	Roughing	HGLB 2020-060 (R1 x Effective Length 6)	12,250	1,800	0.06	0.3	0.02	0:06
3	Semi-finishing		12,250	1,800	0.06	0.05	0.01	0:53
4	Finishing		12,250	900	0.00015 (Cusp Height)	—	0	0:09
5	Finishing	HMERS 4030-01-0750 (ϕ 3 x CR0.1 x Length of Cut 7.5)	8,600	465 / 1,500	0.5	1	0	0:02
6	Finishing		8,600	465 / 1,500	0.0002 (Cusp Height)	1	0	0:01
7	Finishing	HGLB 2010-060 (R0.5 x Effective Length 6)	20,000	800	0.00015 (Cusp Height)	—	0	0:55
8	Finishing		20,000	800	0.01	0.04	0	0:51

Total 4:38

- UDC Series
- CBN Series
- Square
- Long Neck Square
- Radius
- Long Neck Radius
- Taper Neck Radius
- Ball / Long Shank Ball
- Long Neck Ball
- Taper Neck Ball
- Taper
- Spiral V Cutter
- Drill
- EURO Series
- Technical Data

UDC Series

Features of UDC Series for Cemented Carbide

- ◆ Revolutionary Diamond Coating for milling Cemented Carbide
Outstanding hardness, durability and high adhesion coating offers stable and long life milling on Cemented Carbide.
- ◆ Optimum Cutting Geometry
UDC series literally "cuts" the Cemented Carbide and offers highly efficient precise milling.

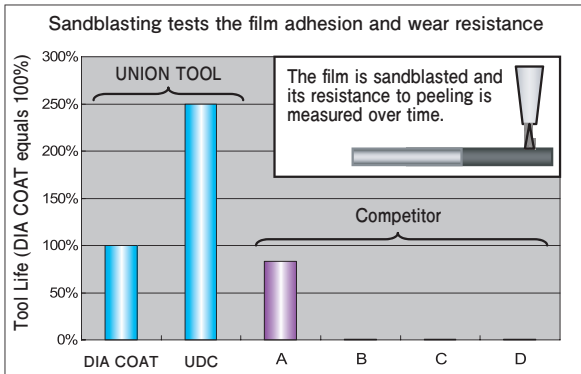

Coating Patented in Japan

UNION TOOL's Diamond film made with a hot filament CVD method improve hardness and durability, with outstanding adhesion to the cutting tool. Using fine particle composition control, the UDC coating has dramatically improved hardness and durability.

Direct Milling on Cemented Carbide!

◆ Ball Series

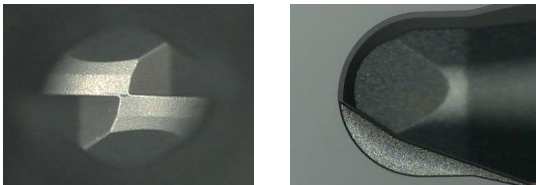

◆ Radius Series

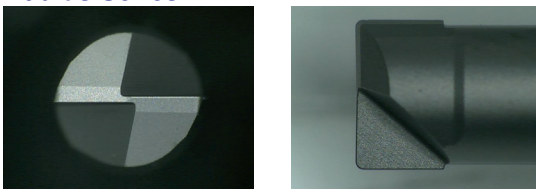

◆ Drill and Thread Mill Series

The thinning design improves biting and straight performance, offering highly efficient drilling.

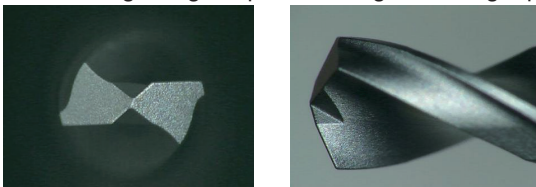

During a deep cut into the Carbide, UDC tools create a "fan-shaped" chip, just like cutting steels!

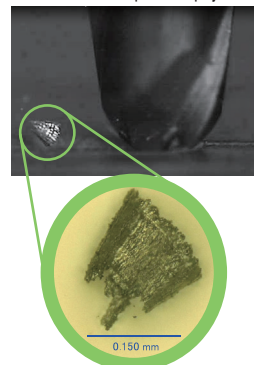

Improved hit counts and hole quality.

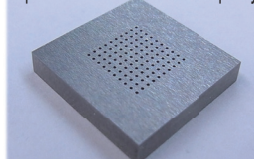

UDC Series

CBN Series

Square

Long Neck Square

Radius

Long Neck Radius

Taper Neck Radius

Ball / Long Shank Ball

Long Neck Ball

Taper Neck Ball

Taper

Spiral V Cutter

Drill

EURO Series

Technical Data

Choose by purposes

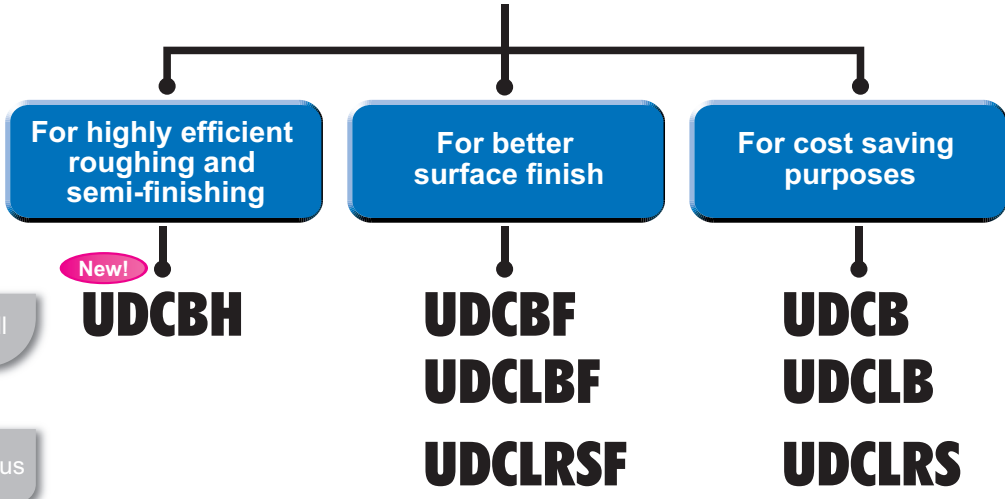

- UDC Series
- CBN Series
- Square
- Long Neck Square
- Radius
- Long Neck Radius
- Taper Neck Radius
- Ball / Long Shark Ball
- Long Neck Ball
- Taper Neck Ball
- Taper
- Spiral V Cutter
- Drill
- EURO Series
- Technical Data

The long-awaited 3rd generation UDC!

UDCBH Patent pending

The best match for roughing and semi-finishing of Cemented Carbide.

What makes UDCBH different

- High-level Treatment!!** → Unbelievable milling performance
- High Speed!!** → Mill at surprisingly high feed rate
- High Material Removal Volume!!** → Highly improved material removal volume



Attain both high efficiency and long tool life!

The key points

New generation edge treatment minimize damage

×

Improved diamond coating to enhance wear resistance



Cemented Carbide Lens shaped milling Comparison of efficiency and material removal volume with UDCBH / UDCBF R1 × Length of Cut 1.4

VM-40 (90 HRA)

New! **UDCBH**

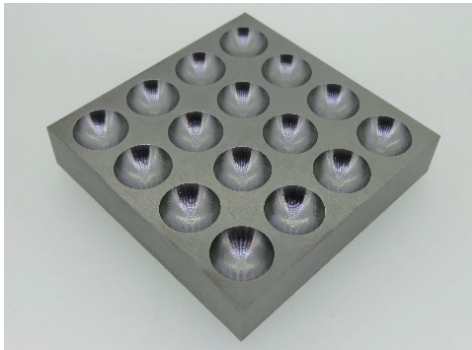

7.5
times
the efficiency

Over **4**
times
the material
removal
volume

Work Size : 50 x 50 x 10 mm

Pocket Size : Top ϕ 10 x Depth 3.5 mm

Material Removal Volume : 160 mm³ / Pocket

Coolant : Air Blow

UDCBH shows maximum tool performance under high-speed conditions.
Tool life may shorten when used at the same feed rate as before.



UDCBH
Milling example

Tool	New! UDCBH	UDCBF
Milling Conditions		
Spindle Speed	30,000 min ⁻¹	20,000 min ⁻¹
Feed Rate	1,500 mm/min	200 mm/min
Axial Depth a_p	0.1 mm	
Radial Depth a_e	0.3 mm	
Milling Results		
1 side 16 pockets	1 Tool Milling time 76 min	4 Tool Milling time 7 h 28 min
Tool after milling 4 pockets		
Tool after milling 16 pockets		

Still functional

- UDC Series
- CBN Series
- Square
- Long Neck Square
- Radius
- Long Neck Radius
- Taper Neck Radius
- Ball / Long Shank Ball
- Long Neck Ball
- Taper Neck Ball
- Taper
- Spiral V Cutter
- Drill
- EURO Series
- Technical Data

The sharpest cutting edge in the UDC series

UDC-F series

The best choice for high quality milling surface

Features of F series

- ① UDC coating → Optimized coating for F series
- ② Special treatment for a sharp edge → Minimized edge chipping and level gap
- ③ Chip pocket designed on tool tip → Excellent surface finish

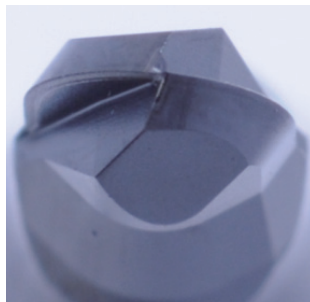
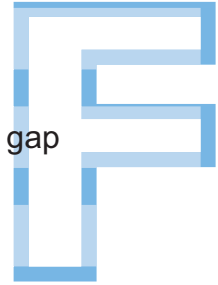

Cemented Carbide Flat surface milling Comparison of edge chipping on work piece
with UDCBH / UDCBF R0.4 × Length of Cut 0.56

VM-40 (90 HRA)

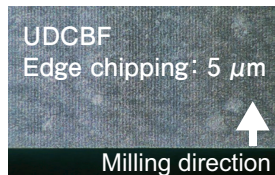
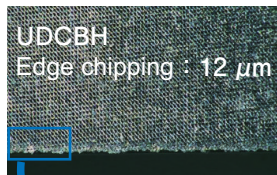

Tool	UDCBH	UDCBF
Spindle Speed	30,000 min ⁻¹	
Feed Rate	750 mm/min	250 mm/min
Axial Depth a_p	0.02 mm	
Radial Depth a_e	0.02 mm	
Coolant	Air Blow	

Improve efficiency and lower costs

by using the right tool based on edge chipping requirements.

- UDC Series
- CBN Series
- Square
- Long Neck Square
- Radius
- Long Neck Radius
- Taper Neck Radius
- Ball / Long Shark Ball
- Long Neck Ball
- Taper Neck Ball
- Taper
- Spiral V Cutter
- Drill
- EURO Series
- Technical Data

UDCLRSF / UDCLRS Milling Examples

Higher efficiency and longer tool life!

Cemented Carbide Curve Slotting Milling Example UDCLRSF $\phi 2 \times \text{CRO.1} \times 2$ VM-40 (90HRA)

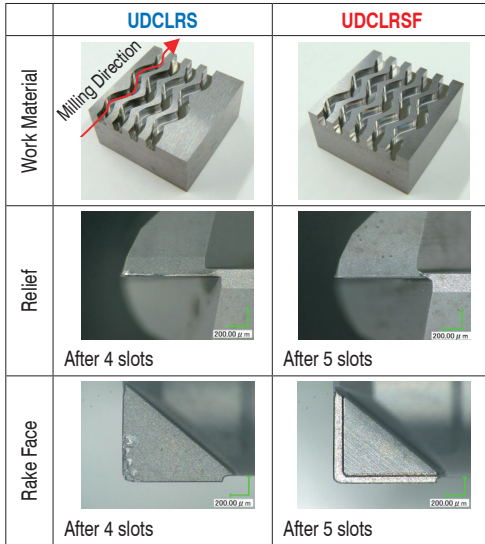

Tool	UDCLRS 2020-010-020	UDCLRSF 2020-010-020
Work Material	Cemented Carbide VM-40 (90HRA)	
Spindle Speed	20,000 min ⁻¹	
Feed Rate	375 mm/min	190 mm/min
Axial Depth a _p	0.02 mm	0.06 mm
Coolant	Air Blow (Nozzle)	
Cycle Time (Per slot)	9 min 4 second	5 min 36 second

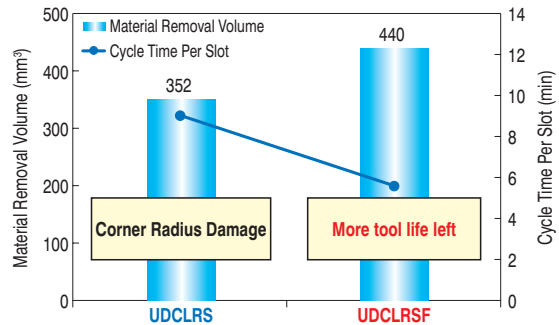

Work Size : 20 mm × 20 mm × 10 mm
Slot Size : Width 2 mm × Depth 1.99 mm

Minimizing Edge Chipping

Cemented Carbide Bottom Surface Milling Example UDCLRSF $\phi 2 \times \text{CRO.03} \times 2$ VM-40 (90HRA)

Edge Chipping Comparison on Work Material

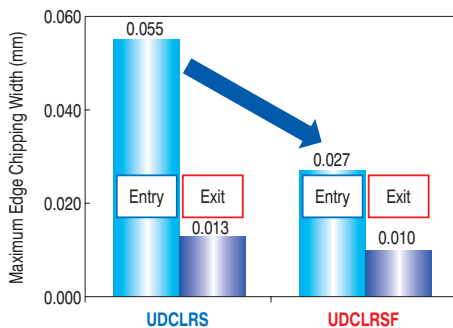
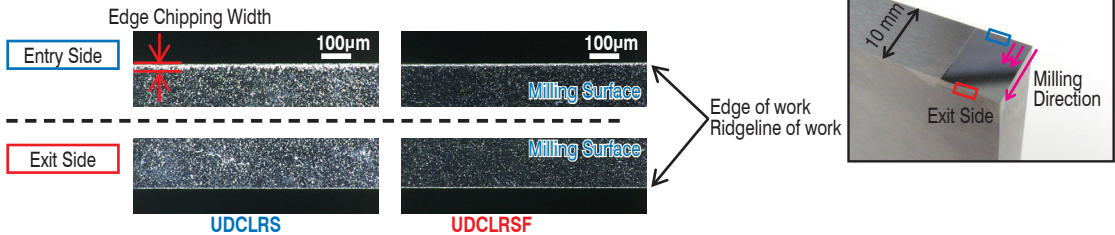

Tool	UDCLRS 2020-003-020 UDCLRSF 2020-003-020
Work Material	Cemented Carbide VM-40 (90HRA)
Spindle Speed	20,000 min ⁻¹
Feed Rate	100 mm/min
Axial Depth a _p	0.01 mm
Radial Depth a _e	0.01 mm
Coolant	Oil Mist
Cycle Time	137 min

UDC Series

CBN Series

Square
Long Neck Square

Radius
Long Neck Radius

Taper Neck Radius

Ball / Long Shank Ball

Long Neck Ball

Taper Neck Ball

Taper

Spiral V Cutter

Drill

EURO Series

Technical Data

CBN F series

Improved sharp edge

The new cutting edge geometry offers high precision milling and long tool life.

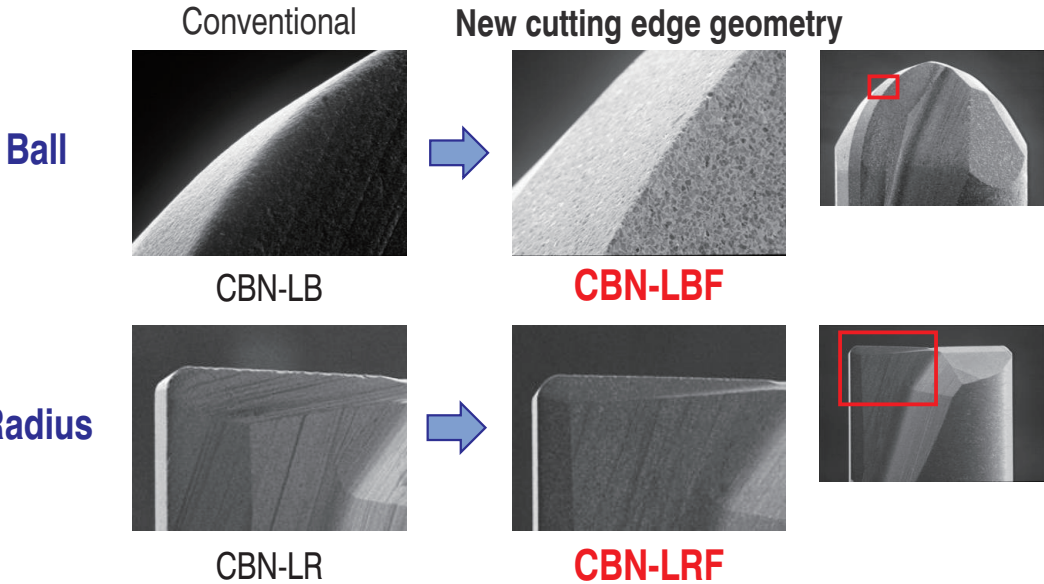

Dramatically improved wear and chipping resistance!

High precision

Long tool life

Minimized tool damage

How to choose CBN Ball

High efficiency milling/
Long tool life

→ **CBN-LBF**
CBN-LRF

Super surface
finish

→ **CBN-LBSF**
CBN-RSF

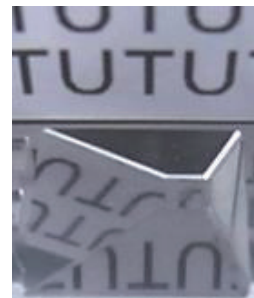

The surface finish is of such high quality that the letters reflect perfectly in it.

SPECIAL END MILLS / DRILLS FROM UNION TOOL

Shape your 'Desire' 'Quickly'.

We manufacture 'Special Tools' over and above our standard items in our catalogue with a **2 weeks manufacturing lead time** to meet customers' request.

Choices available for standard shapes

Shape

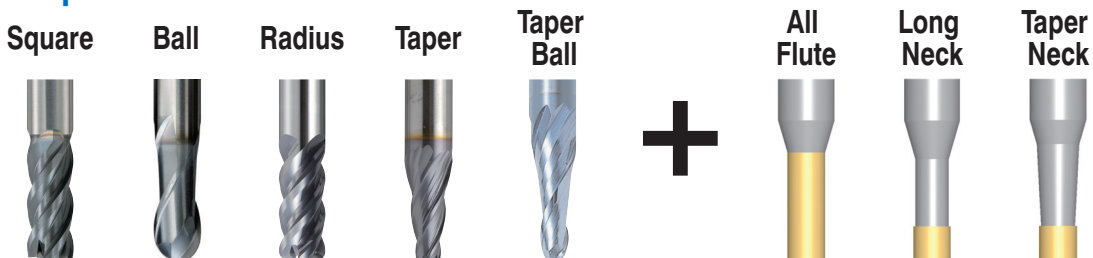

Sizes and Options

Tool Type	Shape	Min Dia.	Max Dia.	Number of Flutes	Options				
					Sharp Corner	Variable Pitch	Variable helix	Back Taper	Thinning
Solid End Mills	Square	φ0.1	φ12	1~6	○	○	○	—	—
	Ball	R0.03	R6	1~4	—	○	○	○	—
	Radius	φ0.2 X CR0.05	φ12 X CR4	2~6	—	○	○	○	—
CBN Tool	Ball	R0.05	R1	2	—	—	—	○	—
	Radius	φ0.1 X CR0.02	φ2 X CR0.5	2	—	—	—	○	—
Solid Drills	Drills	φ0.1	3	2	—	—	—	—	X Thinning

*CBN tools have manufacturing lead-times of more than 2 weeks.

*Variable Pitch and helix are available from 3 flutes.

*Please feel free to ask our sales department for other sizes.

Coatings

Refer to page 6 for the coating selection.

*In case of a repeat order and depending on the requested shape, we may be obliged to exceed two weeks.

- UDC Series
- CBN Series
- Square
- Long Neck Square
- Radius
- Long Neck Radius
- Taper Neck Radius
- Ball / Long Shank Ball
- Long Neck Ball
- Taper Neck Ball
- Taper
- Spiral V Cutter
- Drill
- EURO Series
- Technical Data

Case studies for non standard shapes

How can we help you?

Extend tool life, test trials for new materials, complicated shapes, high precision, improve surface roughness, shorten cycle time,,,

We meet your expectations by **designing tools according to your requirements!**

Case 1 : Barrel End Mills

<Application>:
Highly Efficient Finishing for 5 axis machining



What is a barrel end mill?

The end mill used mainly in 5-axis machining, having a barrel R at the outer peripheral edge.

Standard ball end mills

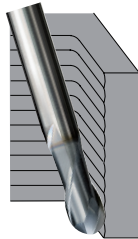

Barrel end mills



Larger a_p

Reduces the cycle time significantly for finishing
>>> Longer tool life

Improves the surface roughness
>>> Less polishing process

Case 2 : Spherical Ball

<Application>: Eliminate burring

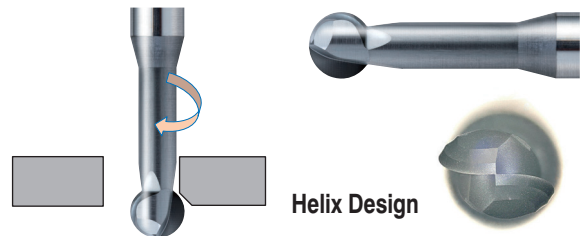

UDC Series

CBN Series

Square

Long Neck Square

Radius

Long Neck Radius

Taper Neck Radius

Ball / Long Shank Ball

Long Neck Ball

Taper Neck Ball

Taper

Spiral V Cutter

Drill

EURO Series

Technical Data

Case studies for non standard shapes

Case 3 : 1 Flute Square for Aluminum / Plastics



<Application>
Less Burring

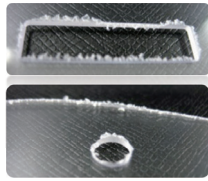

2 Flutes > 1 Flute

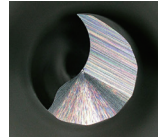
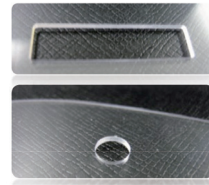

Case 4 : T Slot Cutter

<Application>: Side Slotting

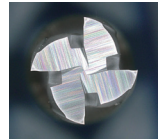
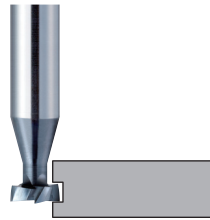

Case 5 : 12 Flute Radius

<Application>:
Highly Efficient and Longer Tool Life on hardened materials

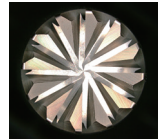

Case 6 : Diamond Coated Diamond Cut Router



<Application>: for CFRP / GFRP

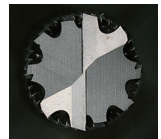

Case 7 : **Micro** Long Drill (30xD)



<Application>: Deep hole drilling

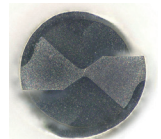

This is an example of a production application. Please feel free to contact us since numerous shapes are available.

UDC Series

CBN Series

Square

Long Neck Square

Radius

Long Neck Radius

Taper Neck Radius

Ball / Long Shank Ball

Long Neck Ball

Taper Neck Ball

Taper

Spiral V Cutter

Drill

EURO Series

Technical Data

Excellent performance in high speed milling for a wide range of work materials and hardness. Our extensive product line starts with micro diameters.

High performance products developed from PCB drill manufacturing technology.

UNIMAX Carbide End Mills

Most of Union Tool's manufacturing equipment is designed and built in-house. We believe that only by having the dedicated fabrications machines designed by engineers who have a thorough knowledge of the products, can we offer uncompromising quality. Since the final process governs the quality of a finished product, all the equipment devoted to final inspection has also been designed in-house. This allows Union Tool to deliver its products with confidence and responsibility.

Union Tool Products

UDC Series

CBN Series

Square

Long Neck Square

Radius

Long Neck Radius

Taper Neck Radius

Ball / Long Shank Ball

Long Neck Ball

Taper Neck Ball

Taper

Spiral V Cutter

Drill

EURO Series

Technical Data



Liner Motion Products



Digital Measurement Equipments



Rolling Die



Heart Rate Sensor



Union Tool's core product is the Printed Circuit Carbide Drill. With a global market share of 30% and a domestic Japanese share of 71%, these ultra precise tools are made at a rate of more than 30 million pieces per month.

Printed Circuit Board Drills



Gave it a try

using our new DLCLB series,
the dedicated tool for a
copper electrode

Housing-rib electrode model

Work material : Copper tungsten
(Cu30% : W70%)
Coolant : Oil mist
Cycle time : 12hr 3min 22sec

Roughing process at
Tremendous speed

Can it finish all
aspects cleanly?

Can the inclined surface
be smooth?

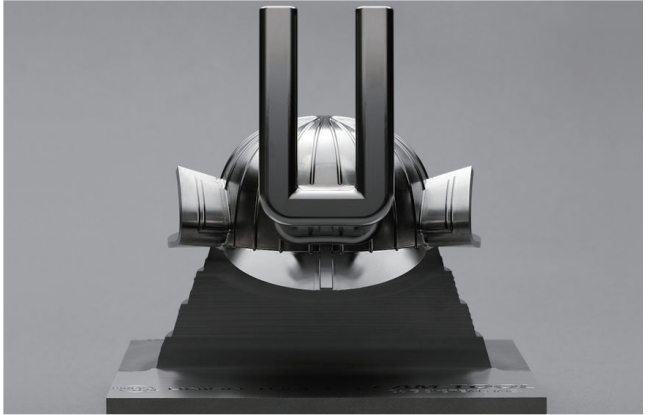
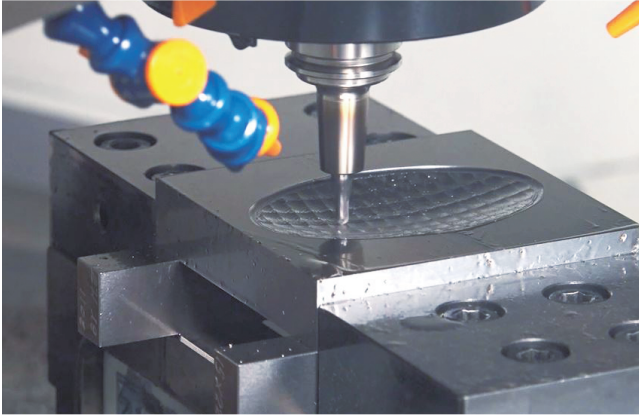
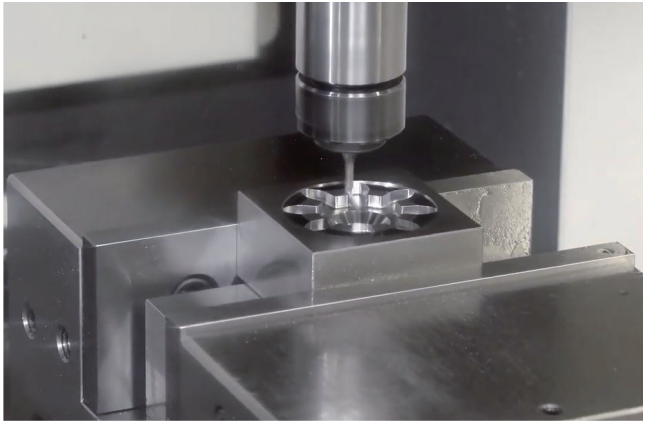

Convincing
finish

DLC coat reduces tool wear
and makes a uniform surface **until the end**

n
29,500 min⁻¹

V_f
,530 mm/min

a_p
0.05 mm

a_e
0.04 mm

Tool
R1 x S
(DLCLB)

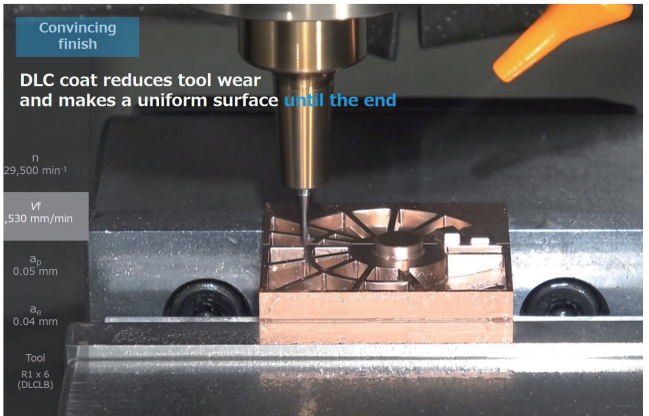

Incredibly fast
cemented carbide
machining

Feed r

1500

mm/min

UDCBH R1



Milling Videos



<https://www.uniontool.co.jp/en/product/endmill/movie/>

UNION TOOL GROUP

HEADQUARTERS

6-17-1 Minami-Ohi, Shinagawa-ku, Tokyo 140-0013, JAPAN
Tel: 81-3-5493-1023 Fax: 81-3-5493-1014

NAGAOKA FACTORY TECHNICAL CENTER NAGAOKA SALES OFFICE

2706-6 Togawa, Settaya-machi, Nagaoka-shi, Niigata 940-1104, JAPAN

MITSUKE FACTORY

3-1 Shinko-cho, Mitsuke-shi, Niigata 954-0076, JAPAN

KITAKANTO SALES OFFICE

Sesion 101, 1425 Egi-machi, Takasaki-shi, Gunma 370-0046, JAPAN

ANJO SALES OFFICE

Mikawa Anjo Hills 2F-A, 2-1-1 Mikawa Anjo-cho, Anjo-shi,
Aichi 446-0056, JAPAN

NAGOYA SALES OFFICE

8F NISSAY Ichinomiya BLDG, 1-2-8 Shinsei, Ichinomiya-shi,
Aichi 491-0912, JAPAN

OSAKA SALES OFFICE

picAsso Mikuni Building, 3-9-14 Niitaka, Yodogawa-ku, Osaka-shi,
Osaka 532-0033, JAPAN

U.S. UNION TOOL, INC.

(U.S. HEADQUARTERS)
1260 N. Fee Ana Street, Anaheim, CA 92807-1817 U.S.A.
Tel: 1-714-521-6242 Fax: 1-714-521-8642

NORTHERN CALIFORNIA REGIONAL SERVICE CENTER

(Customer Service, Santa Clara, California)
1805 Little Orchard Street, Suite 120, San Jose, CA 95125 U.S.A.
Tel: 1-408-982-0205 Fax: 1-408-982-0320

UPPER MIDWEST REGIONAL SERVICE CENTER

(Customer Service, Minneapolis, Minnesota)
155 Bridgepoint Drive, Unit 3 South St. Paul, MN 55075 U.S.A.
Tel: 1-651-552-0440 Fax: 1-651-552-0435

TAIWAN UNION TOOL CORP.

No.180, Zhong-Zun Street., 14 Neighborhood, Bin-Hai Vil.,
Lu-Zhu Dist., Taoyuan City, 338 TAIWAN
Tel: 886-3-354-3111 Fax: 886-3-354-3110

UNION TOOL EUROPE S.A.

Avenue des Champs-Montants 14aCH-2074 Marin /
Neuchatel SWITZERLAND
Tel: 41-32-756-6633 Fax: 41-32-756-6634

UNION TOOL (SHANGHAI) Co., LTD.

No.9-10, Lane 385, Gaoji Road, Sijing High New Technology
Development Zone, Songjiang District, Shanghai, 201601 CHINA
Tel: 86-21-5762-8577 Fax: 86-21-5762-8436

UNION TOOL HONG KONG LTD.

Rm 503, 5/F, Win Century Centre, 2A Mong Kok Rd, Mong Kok,
Kowloon, HONG KONG
Tel: 852-2370-3012 Fax: 852-2370-2111

DONGGUAN UNION TOOL LTD.

YingHua TaiYing Industry Park, Hongmei Town,
Dongguan City, Guangdong, 523160 CHINA
Tel: 86-769-8884-8900 Tel: 86-769-8884-8901
Fax: 86-769-8884-8296

UNION TOOL SINGAPORE PTE LTD.

No.31 Harrison Road, #05-01, SINGAPORE 369649
Tel: 65-6846-9309 Fax: 65-6846-0197

UNION TOOL (THAILAND) CO., LTD.

No.55/73 Moo 15 Bangsaotong Sub-District, Bangsaotong District,
Samutprakarn 10570 THAILAND
Tel: 66-2-130-0908 Fax: 66-2-130-0909



Scan here to view
1. Website catalogs
2. Catalog revision information

 **UNION TOOL CO.**

<https://www.uniontool.co.jp/en/>

Price & Specifications are subject to change without notice.